

Properties of sensorless control systems based on multiscalar models of the induction motor

Zbigniew Krzemiński, Arkadiusz Lewicki, Mirosław Włas

Gdańsk University of Technology, ul. Narutowicza 11/12, 80-952 Gdańsk

e-mail: zkrzem@ely.pg.gda.pl, alewicki@ely.pg.gda.pl, mwlas@ely.pg.gda.pl

Abstract – Generalized multiscalar models of the induction motor are considered as a basis of sensorless control systems presented in the paper. Two types of the multiscalar models are pointed out. The first of the multiscalar model is based on the rotor flux vector. The second one is based on the stator flux vector. Properties of the control systems based on different multiscalar models are similar for the same working points. Application of the speed observer to estimate the rotor speed is considered and properties of control systems based on different multiscalar models are investigated by simulations and compared.

INTRODUCTION

Advanced control systems for the induction motor have been developed recently as sensorless drives. Sensorless means that the speed measurement is replaced in such systems by the estimation.

Properties of the induction motor make it possible to estimate the rotor angular speed in wide range except of working points for which a stator frequency is equal to zero. In these points there is no influence of the variables in the rotor on the variables in the stator. The electromotive force induced in the stator is equal to zero for the zero stator frequency.

Different control schemes and different speed estimators are proposed for the sensorless drive with induction motor but usually problems connected with zero stator frequency are omitted [Kubota, 1990]. The main idea of control systems for the induction motor is application of transformation of variables to receive constant values in steady states. Space vector method and

rotation of frame of references leads to known field oriented control system. Generalization of the space vector method, which lies in nonlinear transformation of the vector components, was proposed in [Krzeminski, 1987] for the induction motor. The stator current and rotor flux vectors were taken into account in transformations and multiscalar model was received in [Krzeminski, 1987]. The other flux vectors are considered for nonlinear transformation of variables in this paper and new multiscalar models are received.

The first author proposed in [Krzeminski, 1999] a method named a speed observer for the induction motor for estimation of the rotor speed. The speed observer consists of a linear dynamical part stabilized by nonlinear feedbacks and a nonlinear expression for calculation of the estimated rotor speed. It is possible to estimate the rotor speed with high accuracy in transients and steady states in wide speed range using the speed observer. Special cases appear for zero stator frequency in sensorless drives based on multiscalar models with application of the speed observer. Properties of the presented control systems are investigated by simulations.

MULTISCALAR MODELS OF THE INDUCTION MOTOR

Nonlinear transformation of variables is used to simplify the model of the induction motor. Commonly known transformation to orthogonal system with variables expressed as space vectors and application of rotating frame of references makes it possible to avoid alternating currents, fluxes and voltages in the motor model. The frame of references is oriented with the flux and only one equation can be linear in such method. More general nonlinear orthogonal transformation proposed in [Krzeminski, 1987] leads to partial linearization of mathematical model of the induction motor. The model received after nonlinear transformation is called a multiscalar model of the induction motor because the variables are scalars. The nonlinear feedback applied to the multiscalar model of induction motor results in full decoupling of the drive into two linear subsystems.

There are two types of the multiscalar models. The general form of multiscalar model of type 1 can be described as follows:

$$\frac{d\mathbf{x}}{d\tau} = \mathbf{A}_x \mathbf{x} + \mathbf{g}_x(\mathbf{x}) + \mathbf{B}_x \mathbf{u}_x + \mathbf{m} . \quad (1)$$

where

$$\mathbf{x} = [x_{11}, x_{12}, x_{21}, x_{22}]^T, \quad \mathbf{g}_x(\mathbf{x}) = [0, g_{x12}(x), 0, g_{x22}(x)]^T, \quad \mathbf{B}_x = \begin{bmatrix} 0 & 0 & 0 & b_{x42} \\ 0 & b_{x21} & 0 & 0 \end{bmatrix}^T, \quad \mathbf{u}_x = [u_{x1}, u_{x2}]^T,$$

$$\mathbf{m} = [0 \quad 0 \quad 0 \quad m_0],$$

\mathbf{A}_x is matrix of coefficients, \mathbf{m}_0 is the load torque, τ is relative time.

The variables \mathbf{x} are defined as the rotor speed, scalar and vector products of two vectors from vector model of the induction motor and square of the flux vector.

The multiscalar variables of the model of type 1 received from transformation of the stator current and rotor flux vectors may be as follows:

$$x_{11} = \omega_r, \quad (2)$$

$$x_{12} = \psi_{r\alpha} i_{s\beta} - \psi_{r\beta} i_{s\alpha}, \quad (3)$$

$$x_{21} = \psi_{r\alpha}^2 + \psi_{r\beta}^2, \quad (4)$$

$$x_{22} = \psi_{r\alpha} i_{s\alpha} + \psi_{r\beta} i_{s\beta} \quad (5)$$

where $i_{s\alpha}, i_{s\beta}, \psi_{r\alpha}, \psi_{r\beta}$ are the stator current and rotor flux vector components and ω_r is the motor velocity.

The differential equations for the variables (2) – (5) are as follows:

$$\frac{dx_{11}}{d\tau} = \frac{L_m}{JL_r} x_{12} - \frac{1}{J} m_0, \quad (6)$$

$$\frac{dx_{12}}{d\tau} = -\frac{1}{T_v} x_{12} - x_{11}(x_{22} + \frac{L_m}{w_\sigma} x_{21}) + \frac{L_r}{w_\sigma} u_{x1}, \quad (7)$$

$$\frac{dx_{21}}{d\tau} = -2\frac{R_r}{L_r} x_{21} + 2R_r \frac{L_m}{L_r} x_{22}, \quad (8)$$

$$\frac{dx_{22}}{d\tau} = -\frac{1}{T_v} x_{22} + x_{11} x_{12} + \frac{R_r L_m}{w_\sigma L_r} x_{21} + R_r \frac{L_m}{L_r} \frac{x_{12}^2 + x_{22}^2}{x_{21}} + \frac{L_r}{w_\sigma} u_{x2}, \quad (9)$$

where

$$T_v = \frac{w_\sigma}{R_r L_s + R_s L_r}, \quad (10)$$

$$u_{x1} = \psi_{r\alpha} u_{s\beta} - \psi_{r\beta} u_{s\alpha}, \quad (11)$$

$$u_{x2} = \psi_{r\alpha} u_{s\alpha} + \psi_{r\beta} u_{s\beta}, \quad (12)$$

where $u_{s\alpha}, u_{s\beta}$ are the stator voltage vector components, R_s, R_r are the stator and rotor resistances, L_s, L_r, L_m are the stator, rotor and mutual inductances. All variables and parameters are expressed in p.u. system.

The variables u_{x1} and u_{x2} are new control variables. The stator voltage vector components are calculated from the following expressions:

$$u_{s\alpha} = \frac{\psi_{r\alpha} u_{x2} - \psi_{r\beta} u_{x1}}{\psi_r^2}, \quad (13)$$

$$u_{s\beta} = \frac{\psi_{r\alpha} u_{x1} + \psi_{r\beta} u_{x2}}{\psi_r^2}. \quad (14)$$

The differential equation for the variable x_{21} does not depend on any control variable. This variable has to be controlled because the value of the square of the rotor flux vector decides on efficiency of the energy conversion in the machine.

The multiscalar model of type 2 may be based on the stator flux vector and takes the following form:

$$\dot{\mathbf{z}} = \mathbf{A}_z \mathbf{z} + \mathbf{g}_z(\mathbf{z}) + \mathbf{B}_z \mathbf{u}_z + \mathbf{m}, \quad (15)$$

where $\mathbf{z} = [z_{11}, z_{12}, z_{21}, z_{22}]^T$, $\mathbf{g}_z(\mathbf{z}) = [0, g_{z12}(z), 0, g_{z22}(z)]^T$,

$$\mathbf{B}_z = \begin{bmatrix} 0 & b_{z22} & b_{z32} & b_{z42} \\ 0 & b_{z21} & b_{z31} & b_{z41} \end{bmatrix}^T,$$

$$\mathbf{u}_z = [u_{z1}, u_{z2}]^T,$$

\mathbf{A}_z is matrix of coefficients and one of the elements b_{z31} and b_{z32} may be equal to zero.

The state variables \mathbf{z} are defined similarly as variables \mathbf{x} for the induction motor model of type1.

The multiscalar variables of the model of type 2 for the stator current and stator flux vectors may be as follows:

$$z_{11} = \omega_r, \quad (16)$$

$$z_{12} = \psi_{s\alpha} i_{s\beta} - \psi_{s\beta} i_{s\alpha}, \quad (17)$$

$$z_{21} = \psi_{s\alpha}^2 + \psi_{s\beta}^2, \quad (18)$$

$$z_{22} = \psi_{s\alpha} i_{s\alpha} + \psi_{s\beta} i_{s\beta}, \quad (19)$$

where $\psi_{s\alpha}, \psi_{s\beta}$ are the stator flux vector components.

The differential equations for the variables (16) – (19) are as follows:

$$\frac{dz_{11}}{d\tau} = \frac{1}{J} z_{12} - \frac{m_0}{J}, \quad (20)$$

$$\frac{dz_{12}}{d\tau} = -\frac{1}{T_v} z_{12} + z_{11} \left(z_{22} - \frac{L_r}{w_\sigma} z_{21} \right) + \frac{L_m}{w_\sigma} u_{z1}, \quad (21)$$

$$\frac{dz_{21}}{d\tau} = -2R_s z_{22} + 2u_{z2}, \quad (22)$$

$$\begin{aligned} \frac{dz_{22}}{d\tau} = & -\frac{1}{T_v} z_{22} - z_{11} z_{12} + \frac{R_r}{w_\sigma} z_{21} - R_s \frac{z_{12}^2 + z_{22}^2}{z_{21}} \\ & + 2 \frac{L_r}{w_\sigma} u_{z2} - \frac{L_m}{w_\sigma} u_{z22}. \end{aligned} \quad (23)$$

where

$$u_{z1} = u_{s\beta} \psi_{s\alpha} - u_{s\alpha} \psi_{s\beta}, \quad (24)$$

$$u_{z2} = u_{s\alpha} \psi_{s\alpha} + u_{s\beta} \psi_{s\beta}, \quad (25)$$

$$u_{z22} = u_{s\alpha} \psi_{r\alpha} + u_{s\beta} \psi_{r\beta}. \quad (26)$$

The variables u_{z1} and u_{z2} are new control variables. The stator voltage vector components are calculated from the following expressions:

$$u_{s\alpha} = \frac{w_\sigma \psi_{r\beta} u_{z1} + 0.5 (w_\sigma i_{s\alpha} - L_r \psi_{r\alpha}) u_{z2}}{w_\sigma x_{22} - L_r x_{21}}, \quad (27)$$

$$u_{s\beta} = \frac{-w_\sigma \psi_{r\alpha} u_{z1} + 0.5 (w_\sigma i_{s\beta} - L_r \psi_{r\beta}) u_{z2}}{w_\sigma x_{22} - L_r x_{21}}. \quad (28)$$

The differential equation for the variable z_{21} depends on the control variable u_{z2} . This variable has to be controlled because the value of the square of the stator flux vector decides on efficiency of the energy conversion in the machine. On the other hand the control variables appear in three equations. This means that three dependencies may be received for the control variables but only two stator voltage vector components may be used for the control of the system. The variable z_{22} may remain uncontrolled directly.

SPEED OBSERVER

A new kind of speed observer for the induction motor proposed in [Krzeminski, 1999] is based on the estimation of disturbances instead of extending the Luenberger observer [Orlowska-Kowalska, 1996]. Differential equations of the induction motor considered for construction of the observer are of the following form:

$$\frac{di_{sx}}{d\tau} = a_1 i_{sx} + a_2 \psi_{rx} + a_3 \omega_r \psi_{ry} + a_4 u_{sx}, \quad (29)$$

$$\frac{di_{sy}}{d\tau} = a_1 i_{sy} + a_2 \psi_{ry} - a_3 \omega_r \psi_{rx} + a_4 u_{sy}, \quad (30)$$

$$\frac{d\psi_{rx}}{d\tau} = a_5 i_{sx} + a_6 \psi_{rx} - \omega_r \psi_{ry}, \quad (31)$$

$$\frac{d\psi_{ry}}{d\tau} = a_5 i_{sy} + a_6 \psi_{ry} + \omega_r \psi_{rx}, \quad (32)$$

$$\frac{d\omega_r}{d\tau} = \frac{L_m}{J L_r} (\psi_{rx} i_{sy} - \psi_{ry} i_{sx}) - \frac{1}{J} m_0, \quad (33)$$

where

$$a_1 = -\frac{R_s L_r^2 + R_r L_m^2}{w L_r}, \quad a_2 = \frac{R_r L_m}{w L_r}, \quad a_3 = \frac{L_m}{w}, \quad a_4 = \frac{L_r}{w}, \quad a_5 = \frac{R_r L_m}{L_r}, \quad a_6 = -\frac{R_r}{L_r}, \quad w = L_s L_r - L_m^2,$$

The equations (29) – (32) describe electromagnetic phenomena in the motor and together with (33) form nonlinear model of the induction motor. Nonlinearities in the electromagnetic part of the model are expressed by products $\omega_r \psi_{rx}$ and $\omega_r \psi_{ry}$. If these products are replaced by new variables, interpreted as disturbances in the model of the induction motor, the equations (29) – (32) become linear. The disturbances may be estimated on outputs of integrators added to the observer based on

the differential equations of the induction motor. Resulting observer system is linear with nonlinear feedbacks.

Differential equations of the speed observer proposed in [Krzeminski, 1999] are as follows:

$$\frac{d\hat{i}_{sx}}{d\tau} = a_1\hat{i}_{sx} + a_2\hat{\psi}_{rx} + a_3\zeta_y + a_4u_{sx} + k_3\left(k_1(i_{sx} - \hat{i}_{sx}) - \hat{\omega}_r\zeta_x\right), \quad (34)$$

$$\frac{d\hat{i}_{sy}}{d\tau} = a_1\hat{i}_{sy} + a_2\hat{\psi}_{ry} - a_3\zeta_x + a_4u_{sy} + k_3\left(k_1(i_{sy} - \hat{i}_{sy}) - \hat{\omega}_r\zeta_y\right), \quad (35)$$

$$\frac{d\hat{\psi}_{rx}}{d\tau} = a_5\hat{i}_{sx} + a_6\hat{\psi}_{rx} - \zeta_y - k_2\left(\hat{\omega}_r\hat{\psi}_{ry} - \zeta_x\right), \quad (36)$$

$$\frac{d\hat{\psi}_{ry}}{d\tau} = a_5\hat{i}_{sy} + a_6\hat{\psi}_{ry} + \zeta_x + k_2\left(\hat{\omega}_r\hat{\psi}_{rx} - \zeta_y\right), \quad (37)$$

$$\frac{d\zeta_x}{d\tau} = k_1\left(i_{sy} - \hat{i}_{sy}\right), \quad (38)$$

$$\frac{d\zeta_y}{dt} = -k_1\left(i_{sx} - \hat{i}_{sx}\right), \quad (39)$$

$$\hat{\omega}_r = S \left(\sqrt{\frac{\zeta_x^2 + \zeta_y^2}{\hat{\psi}_{rx}^2 + \hat{\psi}_{ry}^2}} + k_4(V - V_f) \right), \quad (40)$$

$$V = \hat{\psi}_{rx}\zeta_y - \hat{\psi}_{ry}\zeta_x, \quad (41)$$

where $\hat{\cdot}$ denotes estimated variables, ζ_x, ζ_y are disturbances, V_f is filtered value of variable V , S is sign of the speed determined from expression:

$$S = \text{sgn}(\hat{\psi}_{rx}\zeta_x + \hat{\psi}_{ry}\zeta_y) \quad (42)$$

and k_1, k_2, k_3, k_4 are gains of the observer.

The main feedbacks applied in the observer occur in the equations (38) and (39). The observer is defined in stationary frame of references, which means that the disturbances ζ_x, ζ_y are sinusoidal in steady states. For small gain k_1 the current errors have to be sinusoidal too. It is the reason that the observer operates with errors in steady states. These errors depend on the rotor speed and grow if the speed increases.

Without other feedbacks the observer is separated into two independent parts for two coordinates. Solution for each part consists of sum of constant components and sinusoidal components for stationary states. To eliminate the constant components the feedback with gain k_2 was introduced to the equations (36) and (37). A form of the feedback results from conditions in steady state. The gain k_2 should depend on absolute value of the rotor speed and has to be small for low speed.

Small oscillations of the estimated currents appear in the observer with gains k_1, k_2 . To damp the oscillations the feedbacks with gain k_3 is applied in equations (34) and (35). Form of the feedback results from application of the current errors and steady state values of these errors calculated approximately from (38) and (39).

Finally the compensating feedback is applied in the equation (40). The signal V was chosen to damp the oscillations of the estimated rotor speed. Value of the signal V is near zero states in steady for low speed and is small for high speed. Subtraction of the filtered signal V_f reduces error of the estimated speed to zero in steady states.

The speed observer may be used in the closed control system of the induction motor.

CONTROL SYSTEMS BASED ON MULTISCALAR MODELS OF THE INDUCTION MOTOR

Take figure 1

A nonlinear feedback transforms a nonlinear system into linear system as it has been shown in Fig. 1.

Application of the nonlinear controls of the form:

$$u_{x1} = \frac{w_\sigma}{L_r} \left(x_{11} \left(x_{22} + \frac{L_m}{w_\sigma} x_{21} \right) + \frac{1}{T_v} m_{x1} \right), \quad (43)$$

$$u_{x2} = \frac{w_\sigma}{L_r} \left(-x_{11} x_{12} - \frac{R_r L_m}{L_r w_\sigma} x_{21} - \frac{R_r L_m}{L_r} \frac{x_{12}^2 + x_{22}^2}{x_{21}} + \frac{1}{T_v} m_{x2} \right), \quad (44)$$

transforms the system (6) – (9) of type 1 into two independent linear subsystems:

– mechanical subsystem

$$\frac{dx_{11}}{d\tau} = \frac{L_m}{J L_r} x_{12} - \frac{1}{J} m_0, \quad (45)$$



$$\frac{dx_{12}}{d\tau} = \frac{1}{T_v}(-x_{12} + m_{x1}), \quad (46)$$

- electromagnetic subsystem

$$\frac{dx_{21}}{d\tau} = -2\frac{R_r}{L_r}x_{21} + 2\frac{R_r L_m}{L_r}x_{22}, \quad (47)$$

$$\frac{dx_{22}}{d\tau} = \frac{1}{T_v}(-x_{22} + m_{x2}) \quad (48)$$

In similar way the nonlinear controls of the form

$$u_{z1} = \frac{w_\sigma}{L_m} \left(m_{z1} - z_{11} \left(z_{22} - \frac{L_r}{w_\sigma} z_{21} \right) \right), \quad (49)$$

$$u_{z2} = 0.5 \frac{1}{T} \cdot (m_{z2} - z_{21}) + R_s z_{22} \quad (50)$$

transform the system (20) – (23) into two subsystems:

- mechanical subsystem

$$\frac{dz_{11}}{d\tau} = \frac{1}{J} z_{12} - \frac{m_0}{J}, \quad (51)$$

$$\frac{dz_{12}}{d\tau} = \frac{1}{T_v}(-z_{12} + m_{z1}), \quad (52)$$

- electromagnetic subsystem

$$\frac{dz_{21}}{d\tau} = \frac{1}{T}(-z_{21} + m_{z2}), \quad (53)$$

$$\frac{dz_{22}}{d\tau} = -\frac{1}{T_v} z_{22} - z_{11} z_{12} + \frac{R_r}{w_\sigma} z_{21} - R_s \frac{z_{12}^2 + z_{22}^2}{z_{21}} + \frac{L_r}{T w_\sigma} (m_{z2} - z_{21}) + 2 \frac{L_r}{w_\sigma} R_s z_{22} - \frac{L_m}{w_\sigma} u_{z22}. \quad (54)$$

The equation (54) is nonlinear but describes uncontrolled part of the system and may be omitted during synthesis of the control system.

Application of the multiscalar model of type 1 in the nonlinear control system results in two subsystems with order of each of them equal to two. If the multiscalar model of type 2 is used, the control system may be designed with assumption that the first subsystem is of order 2 and the second one is of order 1.

Take figure 2

General structure of the control system with observer of variables is presented in Fig. 2. The controllers are configured in two cascades for the system of type 1 or one cascade and one controller for the system of type 2. The cascades of controllers are usually applied in the drive systems making it possible to limit the variables in the inner loop. Properties of the closed loop system depend not only on dynamics of the controlled plant but also on exactness of the observer. If all controlled variables used in the closed loop are received on the observer outputs, the controllers control the observer rather than the plant.

Each type of the multiscalar model has different properties when applied in the control system. Usually the variable with index 21 are controlled because this is the variable deciding on flux level and transformation of electrical energy into mechanical energy. In the multiscalar model of type 1 the variable 21 is controlled indirectly by changing the variable with index 22. From the other point of view the variable 22 influences directly on the derivative of variable 21. In the multiscalar model of type 2 the derivative of variable 21 is directly controlled by the control variable. The variable 22 is influenced by controls but is not controlled in the system. This variable may only be used in formulas for limitation of inverter current supplying the induction motor.

Change of the variable 21 may be faster in the system based on type 2 multiscalar model than in the system based on type 1 model.

PROPERTIES OF NONLINER CONTROL SYSTEMS WITH SPEED OBSERVER

The full control system for the induction motor with the speed observer was modeled for simulation purpose by eleven differential equations and four or three controllers. Analytical investigations are complicated for such system and only simulation were used to verify and compare proposed nonlinear feedback.

Take figure 3

Take figure 4

The main results of simulations are presented in Fig. 3 for the system of type 1 and in Fig. 4 for the system of type 2. All variables are expressed in p.u. Variables from speed observer are denoted by additional subscript "o". Reverse of the speed with stopping for zero is presented. The systems

are stable for zero speed. In general, in the most of working points properties of both systems are similar. Transients of variables for system of type 2 are smoother than transients of variables in the systems of type 1.

Take figure 5

Take figure 6

Special phenomena may appear in the control systems based on the multiscalar models with application of the speed observer if the stator frequency is equal to zero or near zero. Such very low stator frequency appears for low rotor speed and generating range of motor torque. The working points for zero stator frequency are unstable and speed error appear in the drive with speed observer. Oscillations of small amplitude may be observed for working points with very low stator frequency as can be observed in Fig. 7 for the system of type 1 and Fig. 8 for the system of type 2. The same working point was selected with x_{210} equal to 1. Similar transients of variables suggest that the small oscillations results from observer properties rather than from structure of the control system.

Take figure 7

Take figure 8

CONCLUSIONS

The special phenomena in the nonlinear control systems of the induction motor based on the multiscalar models with the speed observer applied for estimation of the rotor angular speed have to be taken into account in development of the drive system. Application of multiscalar models of the induction motor results in different properties of the drive system. Investigations will be continued to find more general rules for stabilization of the control systems based on the multiscalar models and the speed observer of the induction motor.

REFERENCES

- Krzemiński Z. (1987): Nonlinear Control of Induction Motor. IFAC 10th World Congress on Automatic Control, Munich, p.p. 349-354.
- Krzemiński Z. (1999): A new speed observer for control system of induction motor. IEEE Int. Conference on Power Electronics and Drive Systems, (PEDC'99), Hong Kong, p.p. 555-560.

Kubota H., Matsuse K., Nakano T. (1990): New adaptive flux observer for wide speed range motor drives. Proc. of The 16th Annual Conference of the IEEE Industrial Electronics Society (IECON'90), p.p. 921-926.

Orłowska-Kowalska T. and Wojsznis P. (1996): Comparative study of rotor flux estimators sensitivity in the speed sensorless induction motor drive, Proc. of IEEE International Symposium on Industrial Electronics (ISIE'96), Warsaw, p.p. 348-353.

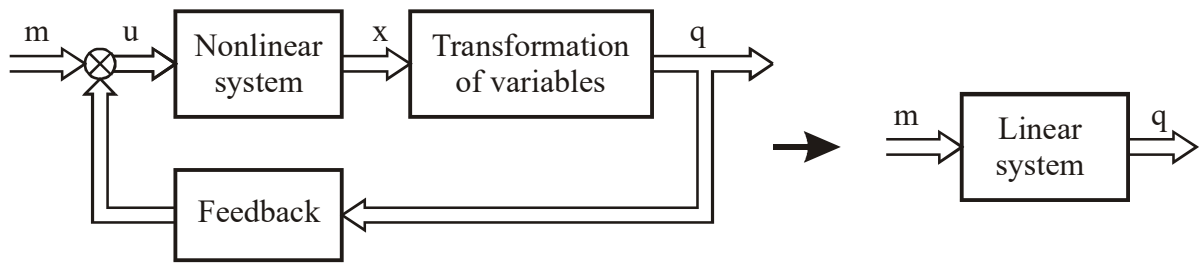

Fig. 1. Transformation of the nonlinear system into the linear system

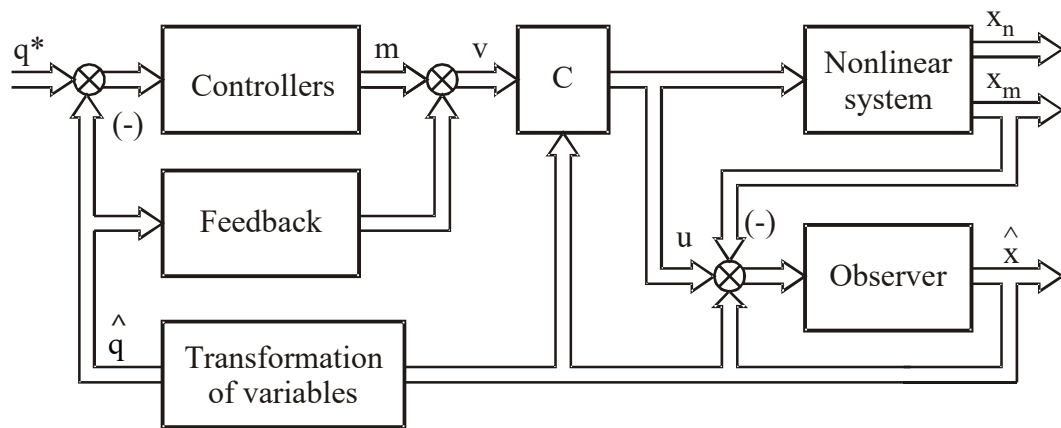

Fig. 2. Structure of the control system with observer of variables

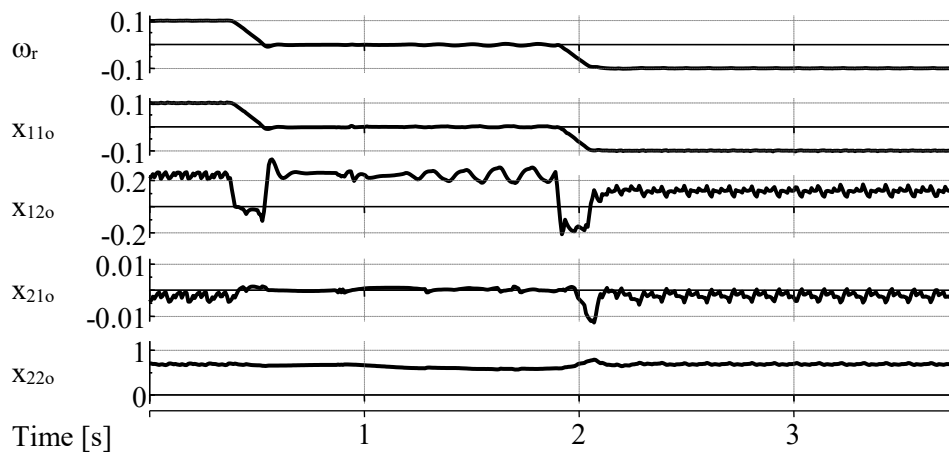

Fig. 3. Simulation of speed reverse with stopping for zero in the system based on the type 1 model with speed observer

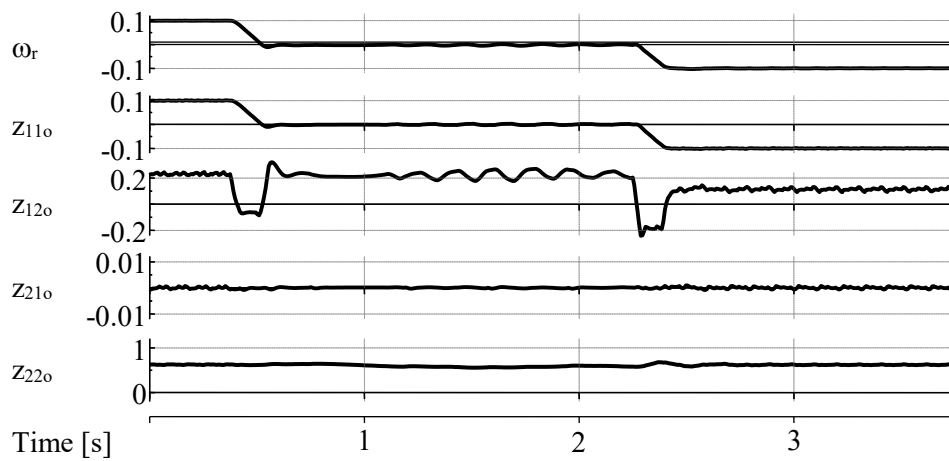

Fig. 4. Simulation of speed reverse with stopping for zero in the system based on the type 2 model with speed observer

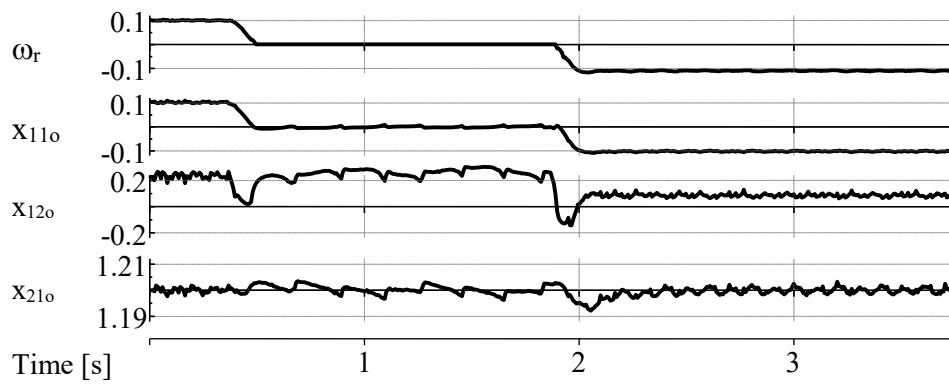

Fig. 5. Experimental results of speed reverse with stopping for zero in the system based on the type 1 model with speed observer

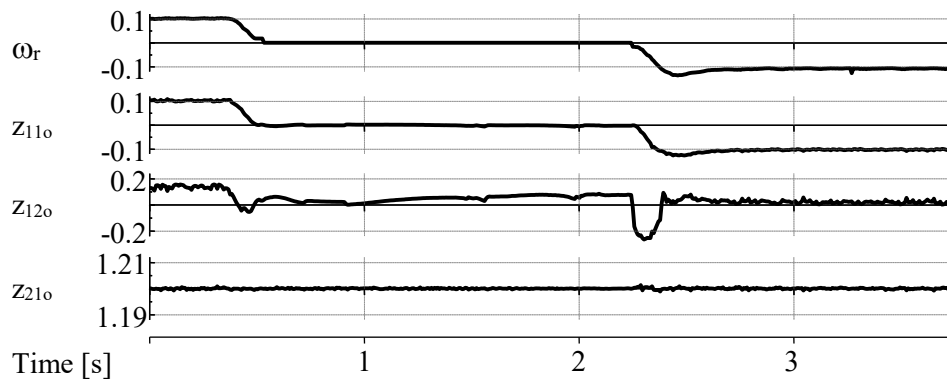

Fig. 6. Experimental results of speed reverse with stopping for zero in the system based on the type 2 model with speed observer

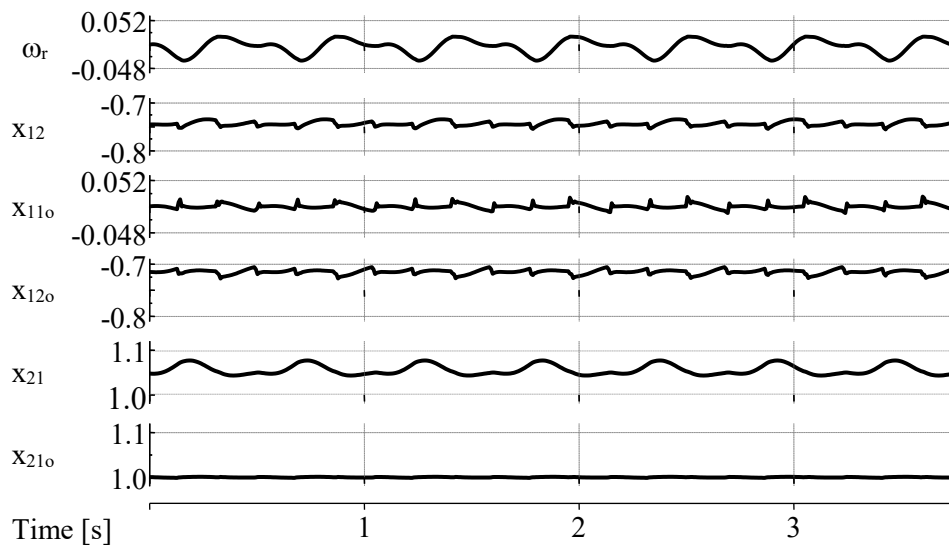

Fig. 7. Simulation transients for steady state near zero stator frequency for the control system of type 1 with speed observer

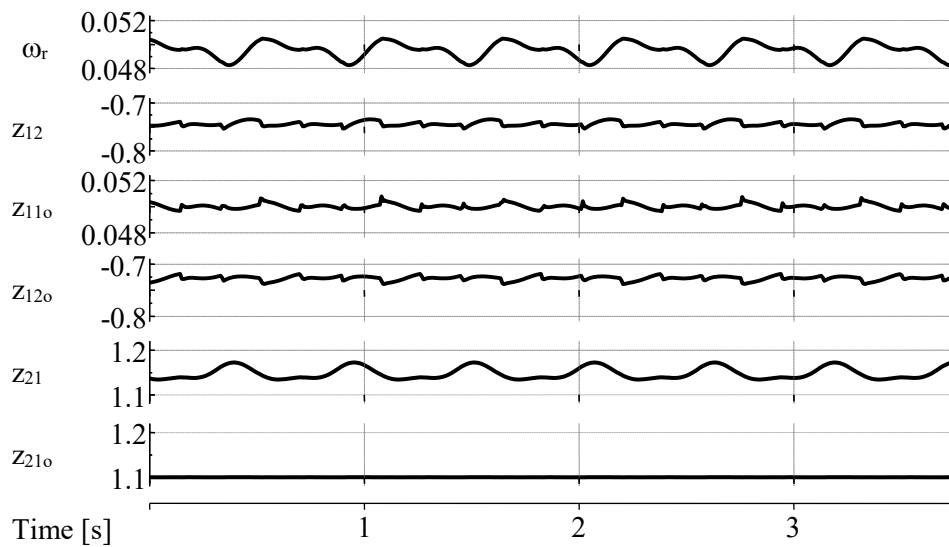

Fig. 8. Simulation transients for steady state near zero stator frequency for the control system of type 2 with speed observer