

## **SELECTED PROBLEMS OF EXPERIMENTAL INVESTIGATION OF DYNAMICALLY LOADED JOURNAL BEARINGS**

**Jan Sikora, Jan Kłopocki, Wojciech Majewski**

*Technical University of Gdańsk  
Mechanical Engineering Faculty  
Narutowicza 11/12, 80-952 Gdańsk  
tel. +48 58 3471844, 3471844, fax +48 58 3472742, 3472742  
e-mail: jsikora @pg.gda.pl, jklopock @pg.gda.pl*

### ***Abstract***

*In the paper some problems concerning relations between external bearing loadings and critical lining stresses are described for test stand with rotating load vector. According to the standard ISO 7905/1 this type of test stand, for dynamically loaded slide bearing, is recommended as a basic research unit for material testing in a complete bearing unit. The lining stress calculation results occurred being dependent on applied calculation model. The influence of sliding surface shape and housing stiffness on bearing fatigue have been considered. The MWO-stand operational principle, standard tested half-bearing, bearing housing of rigid profile, bearing housing of edge elastic profile, distribution of radial and circumferential stress in the slide layer of the bearing bush tested in MWO stand, typical damage of the bearing tested, finite element model geometry for bush and housing are illustrated in the paper.*

*Performed calculations revealed that neglecting the shape and dimensions of the housing in calculation model of the contemporary thin-walled multilayer bearing bushes are leading to incorrect evaluation of critical stresses leading to fatigue cracks in slide layers of the bearing tested in machines with rotary load vector. That kind of bearing alloys is not employed in highly dynamically loaded bearings of contemporary machines, especially in IC engine bearing systems*

*Keywords: combustion engine, engine parts, bearings, tribology, bearing fatigue*

### **1. Introduction**

Fatigue damages can appear in a dynamically loaded bearing when the stresses and strains in the sliding layer are reaching their critical level that is depended not only on the type of the bearing material but also on geometry (e.g. bearing dimensions, clearance etc.) and their working parameters. Idea of the analysis of the hydrodynamic bearing fatigue properties is presented in the recommendations of the International Standard: ISO 7905/1-4;1995 [1]. Bearing fatigue strength can be understood as a local load-carrying capacity of the bearing lining for the bearing dynamic mechanical and heat loading, including also the physic-chemical oil effects. Because of very complex fatigue mechanisms and working parameter interrelations, the precise determination of the bearing material fatigue parameters requires the experimental work with the application of specific test devices. Among them especially effective seems to be MWO machine [2] with rotating load vector (Fig.1).

Different criteria are adopted to define the critical state of the slide bearing materials for dynamically loaded journal bearings. The traditional and most frequently used is a maximum specific load in the bearing during the loading cycle although more reasonable would be a maximum amplitude of stress in the bearing slide layer [3].

In the standard ISO 7905/1 a test stand (e.g. MWO machine) for complete bearing fatigue resistance testing with rotating load vector is described as well as the calculating procedure for

finding the critical stress values. Unfortunately, there is not accurate and simple relation between maximum specific load in the bearing (and even maximum pressure in the oil film) and stresses in the bearing slide layer.

## 2. Test stand operational principle and object of investigation

A scheme of the testing head unit of the MWO machine with rotating load vector is shown in the Fig. 1.

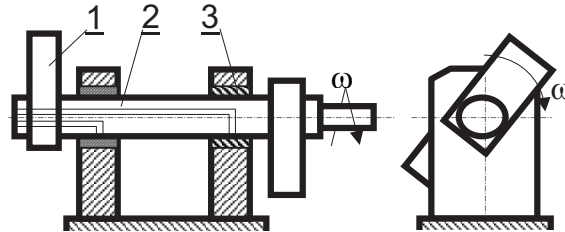

Fig. 1. The MWO-stand operational principle, 1 - unbalanced mass, 2 – testing shaft, 3 – tested bearing

Two model bearing 3 housed in the supports are simultaneously investigated. Bearing loading is produced by rotation of a dynamically unbalanced shaft 2 with masses 1. Load can be controlled by proper selection of masses 1 and rotational speed of the shaft 2. Bearings are fed with lubricating oil through the system of holes in the shaft.

Shape and nominal dimensions of standard half-bearing tested in the MWO machine is presented in the Fig. 2. Usually two- and three-layer metallic bearing bushes are used.

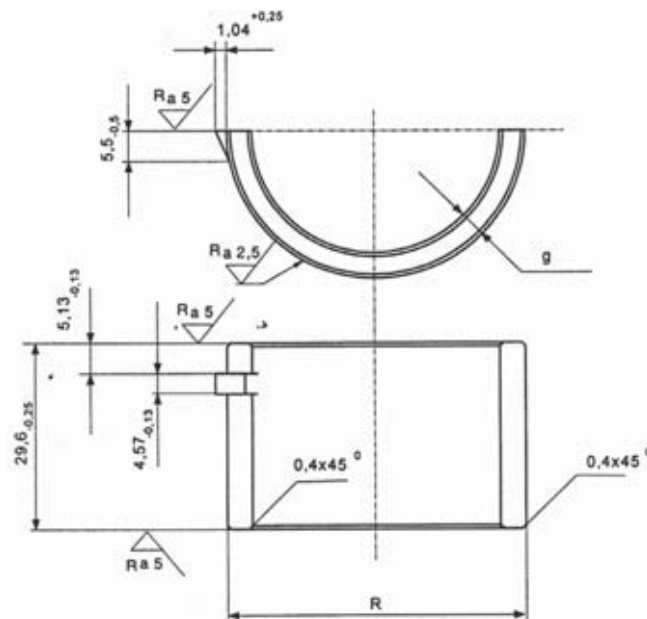

Fig. 2. Standard tested half-bearing

In the work the bimetallic half-bushes consisted of steel shell and lining made of AlSn11,2Cu1,2 or CuPb6 alloy were tested. Chemical composition of the basic alloy results from its symbol. Nominal total bush wall thickness was of 1.825 mm, while lining thickness about 0.39 mm. Surface roughness  $R_a=0.20 \mu\text{m}$ . Surface parameters of steel shaft were: hardness  $60\pm 2 \text{ HRC}$  and  $R_a=0.16 \mu\text{m}$ .

Two different geometry of housing were considered: the rigid one (Fig. 3) and the elastic housing (Fig. 4). Finally the elastic one was accepted as test housing. The elastic housing was designed with reduced stiffness at the edges of the sleeve in order to obtain the maximum pressure

of oil film in the central plane of the bearing. Increasing the elasticity of the housing helps to eliminate the pressure concentration at the edges of the bearing.

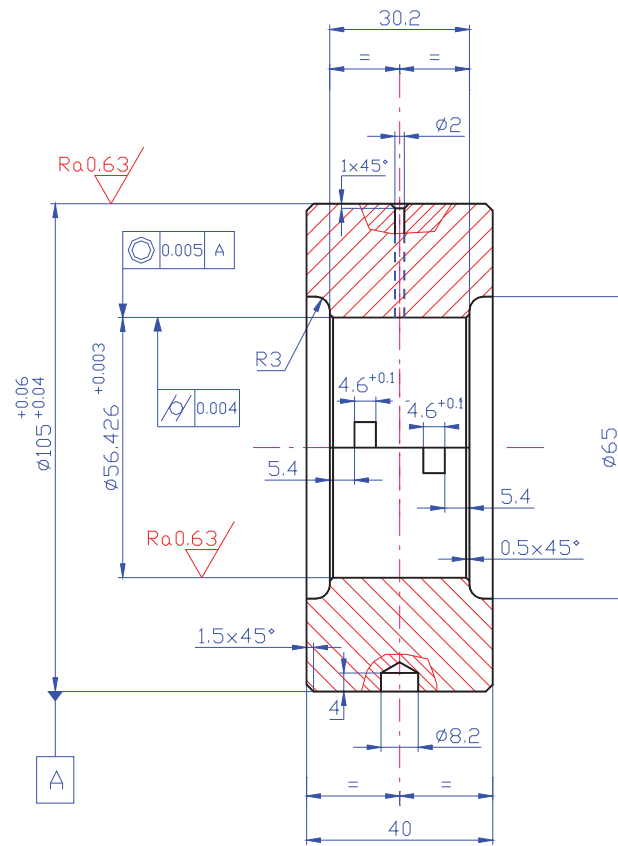

Fig. 3. Bearing housing of rigid profile

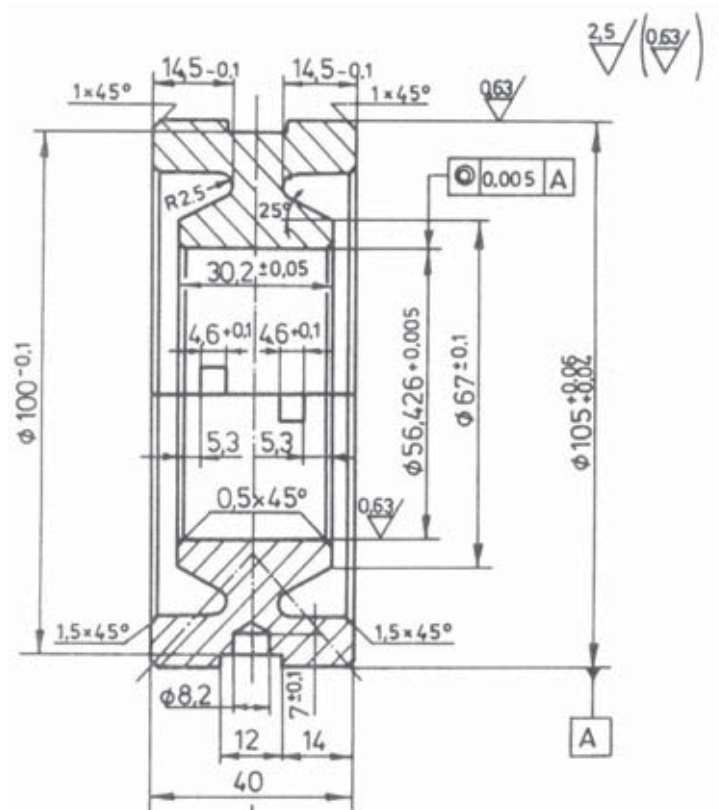

Fig. 4. Bearing housing of edge elastic profile

### 3. Stresses in the bearing shell

For any of the radial section of the shell (bush) the rotation of the shaft (with unbalanced masses) is producing the some dynamic loading. It is also true that the pressure distribution on sliding surface is the same (in case of the symmetry of the bush shape) for any angular position of the loading vector. The same can be said about stress distribution in the bearing lining. The state of stresses, for any instant position of the loading vector, is determined by normal stress (radial, circumferential and axial) and shearing stresses. In case of rotational symmetry, the bearing can be analysed as a statically loaded bearing with rotating bush. It means that the stresses at any point of the bush are changing from minimum to maximum values that are dependent on the pressure distribution for the statically loaded bearings. In the Fig. 5 distribution of radial  $\sigma_R$  and circumferential (tangential) stress  $\sigma_t$  in the slide layer of central plane in the bearing bush tested in the MWO machine is presented.

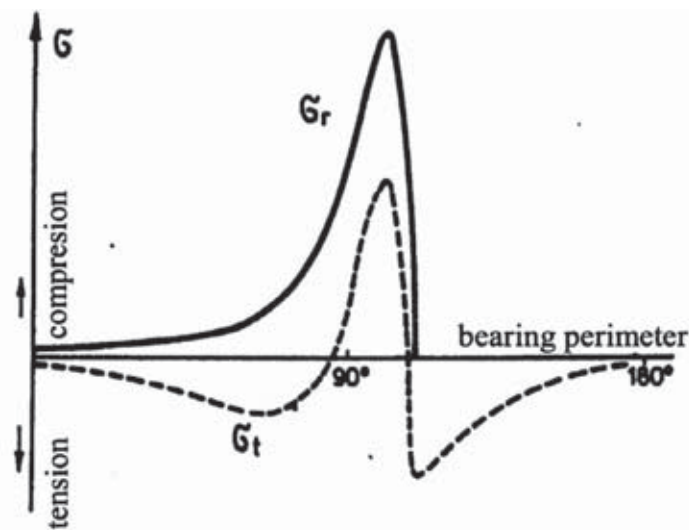

Fig.5. Distribution of radial  $\sigma_R$  and circumferential stress  $\sigma_t$  in the slide layer of the bearing bush tested in MWO stand

This distribution was worked out theoretically by Lang [5] and confirmed by Harbordt [6] and Hacifazlioglu [7]. Especially interesting there is the distribution of circumferential tensional stress with two local extremes. The maximum tensional stress is present in the region of the maximum pressure drop. In the result in bearing lining there are pulsating compressive radial stresses and variable tangential stresses that alternate from tension to compression. Because of the strength parameter asymmetry (tension-compression) for slide bearing materials this change of stresses sign is regarded as being responsible for initiation and development of the fatigue cracks in the bearing lining.

### 4. Testing procedure

Testing procedure for MWO machine is based on two-point strategy of experiment planning and standardised test result processing [3,4]. It has been assumed that the bearing is reaching critical state when any of macroscopically visible cracks occurs on the slide layer surface within the specified number of load cycles that was defined as  $3.6 \times 10^6$ .

Based on the test results the maximum critical value of the oil pressure is determined and the fatigue strength index is calculated [3]. Finally the value of the related normal stress in the slide layer is determined for assumed number of loading cycles. Specification of the design parameters of the tested bearings are presented in the Table 1.

Tab. 1. Design parameter of the tested bearings and testing parameters

Lining material	AlSn11,3Cu1,2	CuPb6
Nominal thickness of bearing bush	1,825 mm	1,825 mm
Thickness of lining	0,388 mm	0,335 mm
Shaft diameter	D = 52,700 mm	
Length of the bearing	L = 29,6 mm	
Nominal relative clearance	$(\Delta R/R) = 0.0017 \div 0,0019$	
Slide surface roughness	$R_a = 0,20 \mu\text{m}$ .	
Surface layer hardness	50 HB	61 HB
Shaft surface parameters (38HMJ)	$60 \pm 2 \text{ HRC}; R_a = 0.16 \mu\text{m}$	
Shaft rotational speed	n = 4000 obr/min	
Fatigue test basis	$3,6 \times 10^6$ load cycles	
Lubricant	Selectol SAE 20W/40	
Feed pressure	0,5 MPa	

On the basis of preliminary test results it can be stated that for rigid housing the axial pressure distribution in the bearing is not parabolic, as it was assumed in the standard ISO 7905/1 calculating procedure but is characterised by very sharp pressure increase (concentration) at the edges of the bearing. It can be explaining by substantial deformation of the shaft occurring at the testing loadings. That is the reason for fatigue damages location at these edges (Fig. 6a) instead of the central plane of the shell. It might be also the reason for seizure damage observed for some of the bearings (Fig. 6c). For elastic housing, the first fatigue cracks are developing in the middle of the bearing (Fig. 6b). The same is in case of the seizure damages (Fig. 6d).

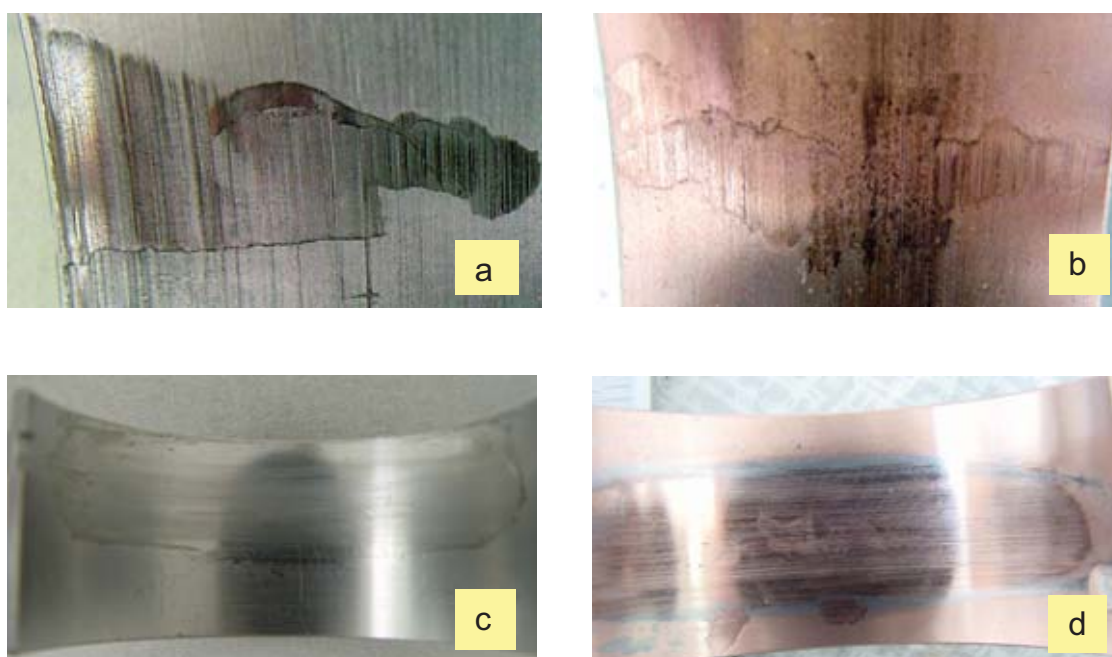

Fig. 6. Typical damage of the bearing tested in the: (a, c) rigid housing, (b, d) elastic housing

#### 4. Calculating model

The purpose of the calculation was to estimate the reliable values of normal stress components for multilayer bearing structure located in the elastic housing (Fig. 5). It was performed for radial slide bearing. Material specification and critical maximum specific load (results of experiments) for two bearing materials are presented in the Table 2.



Tab. 2. Material specification and test results

Variable	Units	Material of sliding layer	
		AlSn11,3Cu1,2	CuPb6
Young's modulus $E$	MPa	$71 \times 10^3$	$53 \times 10^3$
Poisson's number $\nu$	-	0.34	0.34
Bearing clearance ( $\Delta R/R$ )	-	0,0019	0,00175
Maximum specific load ( $(p_{sr})_{max}^*$ )	MPa	21,51	14,14
Bearing loading	kN	34,1	22,0
Bearing temperature $T$	$^{\circ}\text{C}$	80	73

\*) fatigue index according to [3]

At the first step of calculation the pressure distribution was found as for standard hydrodynamic statically loaded bearing. It was assumed that the change of viscosity due to oil temperature rise can be neglected for the temperature reaching  $70^{\circ}\text{C}$ . It means that sufficiently good approximation is isothermic model of the oil flow and pressure distribution. The next step was calculation of the stresses basing on ANSYS programme: 8-nodes solid finite elements having 3 degrees of freedom at each node were adopted. For bearing slide layer the finer meshing was applied for obtaining higher accuracy of calculation. Geometry of finite element model for bush and housing is presented in the Fig.6.

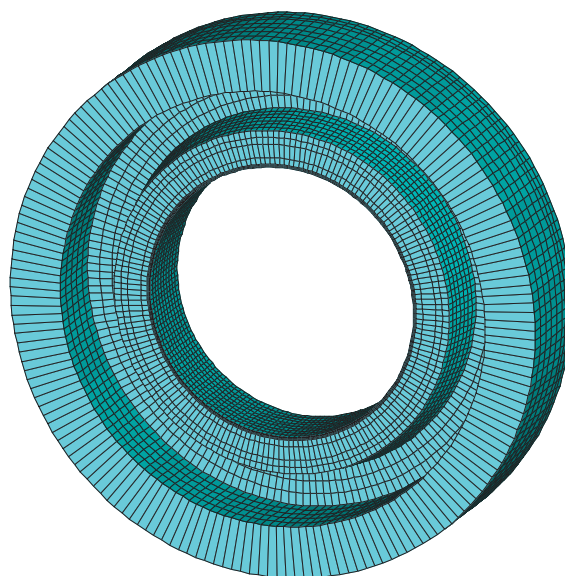

Fig. 7. Finite element model geometry for bush and housing

In modelling of slide bearing layer it was assumed that the mesh consists of 180 elements in circumferential, 10 elements in axial and 4 elements in radial directions. Calculations were limited to the half of the bearing because of symmetry of the system.

## 5. Results

In the Tables 3 and 4 critical tangential stress components in the slide layer of bearing tested in MWO-stand evaluated with different calculating procedures are presented. Stresses distribution for AlSn11,3Cu1,1 and CuPb6 surface layers are identical in pattern but different in the critical values. Results of the FEM calculations taking into account the support of the bearing with elastic housing are given in the Table 3. In the Table 4 circumferential critical stresses are determined in



accordance to the procedure described in standard ISO 7905/1 and based on the assumption that the bearing is fixed in rigid housing.

Tab. 3. Critical tangential stresses for bearing tester on MWO stand (FEM procedure)

Bering material	Loading ratio $-\infty < R < -1$		Tangential stress	
	Amplitude [MPa]	Mean stress [MPa]	maximum $\sigma_{\max}$ [MPa]	minimum $\sigma_{\min}$ [MPa]
AlSn11,3Cu1,2	33,36	-14,51	18,85	-47,86
CuPb6	16,20	-7,37	8,23	-24,17

Tab. 4. Critical circumferential stresses for tested bearing according to ISO 7905/1

Bering material	Loading ratio $-\infty < R < -1$		Tangential stress	
	Amplitude [MPa]	Mean stress [MPa]	maximum $\sigma_{\max}$ [MPa]	minimum $\sigma_{\min}$ [MPa]
AlSn11,3Cu1,2	26,6	-11,2	15,4	-37,8
CuPb6	12,8	-8,8	4,0	-21,6

The critical values of stresses in Tables 3 and 4 are substantially different which can be explained by different oil pressure distribution and bush deformation in the tested bearings resulting from the assumed support conditions (Table 3 – elastic housing, Table 4 – rigid housing).

## 6. Conclusion

Calculations mentioned above have revealed that neglecting the shape and dimensions of the housing in calculation model of the contemporary thin-walled multilayer bearing bushes are leading to incorrect evaluation of critical stresses leading to fatigue cracks in slide layers of the bearing tested in machines with rotary load vector. The method of calculation recommended by ISO 7905/1 standard is reliable only in case of thick-walled full bearing bushes that are typical of bearing with slide layer built on the basis of soft bearing materials, e.g. tin or lead babbitts. That kind of bearing alloys is not employed in highly dynamically loaded bearings of contemporary machines, especially in IC engine bearing systems.

This work has been financed from budget sources on science in 2005-2006 years as a research project (grant) No 4 T07B 029 28.

## References

- [1] ISO 7905/1-4; 1995: Plain bearings – Bearing fatigue-Part I: *Plain bearings is test rig and in applications under conditions of hydrodynamic lubrication*.
- [2] Sikora, J., Stanowisko do badania wytrzymałości zmęczeniowej cienkościennych panwi ślizgowych, *Zmęczenie i Mechanika Pękania*, Materiały XIX Sympozjum Zmęczenia i Mechaniki Pękania, Bydgoszcz, ATR, s. 242-249, 2002.
- [3] Sikora J., *Studia nad metodyką badania wytrzymałości zmęczeniowej łożysk ślizgowych poprzecznych*, Zesz. Nauk. Polit. Gdańskiej, nr 534, Mechanika nr 74, s. 3-228, 1996.
- [4] Sikora, J., *Fatigue investigation of plain journal bearings*, NORTRIB'98: Proceedings of the 8<sup>th</sup> International Conference on Tribology, Ebeltoft (Dania), 8-10.06.1998, DTI Tribology Centre, 1998.
- [5] Lang, O. R., *Gleitlager-Ermüdung unter dynamischer Last*, VDI-Berichte, Nr 248, 1975.

- [6] Harbordt, J., *Beitrag zur theoretischen Ermittlung der Spannungen in der Schalen von Gleitlagern*, Diss TU Karlsruhe ,1976.
- [7] Hacifazlioglu, A., Karadeniz, S., *A parametric study of stress sources in journal bearing*, Journal of Mechanical, Vol. 38, No 8-9, pp. 1001-1015, 1996.

