

Problems of the starting and operating of hydraulic units and systems in low ambient temperature (Part I)

Ryszard Jasiński, Ph. D.
Gdansk University of Technology

ABSTRACT



Severe winters and sweltering summers which more and more often occur nowadays are the reason why machinery designers face many difficulties when designing devices which will be serviceable in extreme ambient conditions. Hence, defining the principles and conditions of safe operation of hydraulically driven machines and devices is essential for their designers and operators. For this reasons the author did a series of tests of hydraulic component and systems in thermal shock conditions (cooled-down component were supplied with hot working medium). In such conditions, starting parameters of the selected hydraulic component and systems which secured safety of their operation were determined. The experimental tests were carried out in the laboratory of the Chair of Hydraulics and Pneumatics, Gdańsk University of Technology.

Keywords: hydraulic machines, hydraulic drives, diagnostics, hydraulic systems

INTRODUCTION

Hydraulic systems used in numerous machines and devices operating in a given climatic zone should work reliably in various atmospheric conditions characteristic of the zone in question. The influence of low temperature is highly unfavourable for hydraulic system serviceability during the period of machine start-up, especially after its long lasting stand-by.

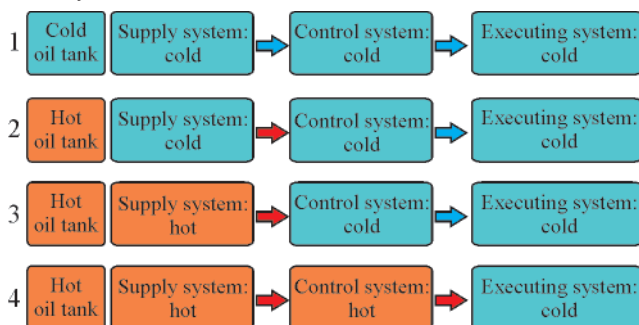

Fig. 1. Four cases of starting conditions of a hydraulic system at low ambient temperature

Starting the hydraulic system at low ambient temperature can be performed using either cold or hot working medium, which is usually hydraulic oil.

The following cases of starting the hydraulic system at low temperature are possible (Fig. 1):

1. at the instant of starting, all hydraulic component of the working machine have the same low initial temperature, which means that the working medium flows from the supply system to the cold control and executing component

2. the oil in the tank is heated up, whereas the supply, control, and executing component are cooled down
3. the temperature of the supply system is higher than that of the cooled-down control and executing component
4. the executing component are cooled down, whereas the supply system and control component are of higher temperature.

In the 1st case, at the starting instant the complete hydraulic system together with the oil are of the same temperature as the environment, whereas in the remaining cases of system start-ups (i.e. cases 2, 3, and 4 above) the oil, just before its delivery to the cooled-down unit, is heated up to a temperature much higher than the ambient one. These are the conditions for the appearance of a thermal shock.

On the basis of the provisions of the Polish standard [6] and the rules of Polish Register of Shipping (PRS) [7, 8] on the serviceability of hydraulic component in sub-freezing temperature conditions, the following requirements can be formulated:

- ❖ cooled-down hydraulic component (including hydraulic motors and cylinders) should correctly operate when they are supplied, in a stepwise mode, with hot oil of a temperature higher by up to 50 K than that of the unit
- ❖ according to the PRS rules, tests of hydraulic component should be performed in the most unfavourable supply conditions. It means for Z-class component operating at the temperature of -25 °C and supplied with the working medium of the temperature of 50 °C, recommended for hydraulic devices, that their operation is to be checked at the temperature difference between the oil and the environment equal to 75 °C.

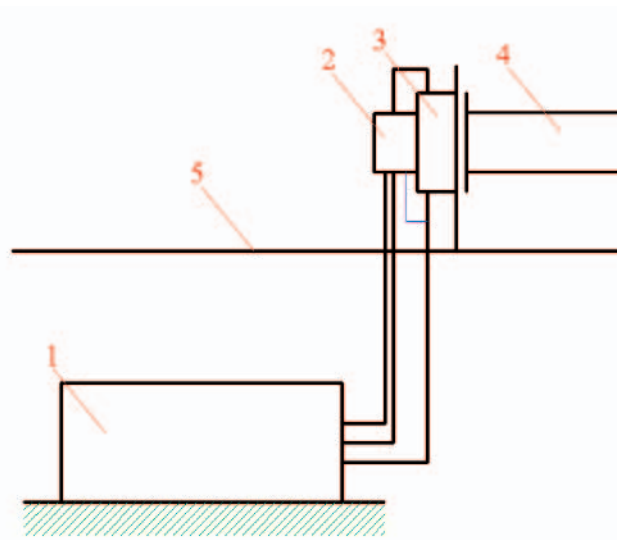
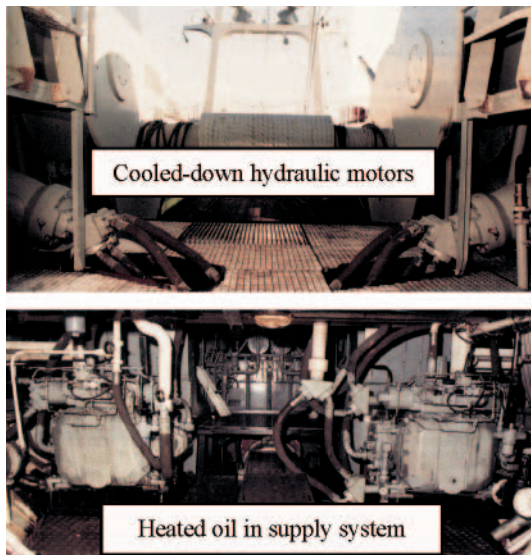

Fig. 2. Simplified schematic diagram of supplying the hoisting winch: 1 – ship's central oil supply system, 2 – set of valves, 3 – hydraulic motor, 4 – hoisting winch, 5 – ship's deck

In extreme conditions of supplying a cooled-down unit with hot working medium, observed in case of shipboard devices, for instance, the difference between the above temperatures may even reach as much as 80 K.

The ship's hydraulic hoisting winch, shown in Fig. 2, contains hydraulic component exposed to thermal shock conditions. Its supply system is situated under the deck and the oil inside it is heated as a result of its earlier work. After switching over the valve placed on the deck, Fig. 1 case 3, the oil will flow from the supply system to the motor, the temperature of which is equal to the ambient temperature. Consequently, dynamic heat transfer from the hot oil to the cooled-down shipboard hydraulic component will take place, changing the temperature of the component. Elements of the hydraulic component will be heated non-uniformly, which may result in the elimination of the clearances between the co-operating elements, and, as a further consequence, may lead to the failure of the hydraulic unit. The hoisting winches are usually driven by hydraulic motors.

In heavy-duty machines, for instance those used for earth work, all cases of hydraulic system start-ups represented in Fig. 1 can happen. The bulldozer, shown in Fig. 3, contains two or more hydraulic systems. One of them is the travelling system, responsible for supplying the motors which drive wheels or caterpillars. The other is the working system, which consists of a number of working component. The cooled-down motors (1) of the travelling system may be heated up uniformly like the remaining component of the system, as a result of the loss of energy in the system (Case 1 in Fig. 1), or dynamically when supplied with the hot oil heated up in advance in a preliminary supply pump circuit (thermal shock conditions) (Case 4 in Fig. 1). The executing and control component (2) of the hydraulic working system of the bulldozer in question are exposed to thermal shock conditions corresponding to case 3 and 4 in Fig. 1.

The start-up of a system in winter conditions of low ambient temperature is characteristic of decreased efficiency of particular component and the entire machine, in which higher vibrations and noise are produced. In these very unfavourable conditions, shorter lifetimes and more frequent failures of the hydraulic component are observed.

For the above reasons the author performed tests of hydraulic component of various designs in low ambient temperatures. The tests made it possible to detect and describe the phenomena which take place in hydraulic component and systems during their start-ups in such conditions.

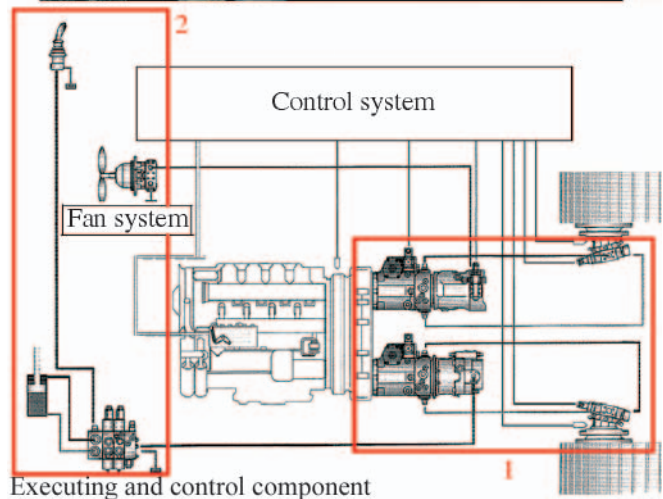

Fig. 3. Hydraulically driven bulldozer: 1 – travelling system, 2 – working unit and fan systems [10, 11]

PHENOMENA WHICH OCCUR IN HYDRAULIC COMPONENT AND SYSTEMS DURING THEIR START-UPS AT LOW AMBIENT TEMPERATURE

During the start-up of the hydraulic unit at low ambient temperature many unfavourable phenomena may occur. One of them is decreased hydraulic - mechanical efficiency, which results in lower overall efficiency of the hydraulic component.

The volumetric efficiency usually increases a little as compared to that in the normal starting conditions if only the cavitation does not occur.

During the start-up of the system in thermal shock conditions, the effective clearance between the co-operating elements changes. When the temperature difference between the working medium and the cooled-down hydraulic unit is too high, the clearance may completely disappear, thus leading to the failure of not only the individual unit but also of the entire system. There are various designs of hydraulic component. Each design includes certain characteristic points (nodes) of co-operation between the elements in which the disappearance of the clearance can happen. Due to a huge variety of the existing design solutions [1, 5], only the most commonly used hydraulic component of heavy-duty machines are presented in the article.

In the axial piston pumps and motors, e.g. those with cam timing gear (Fig. 4), as well as in the radial ones, the disappearance of the clearance between plungers and cylinders, between the foot and the keep plate (in designs with hydrostatic support), as well as between particular elements of the timing gear can take place. In gear pumps and motors the disappearance of the axial clearance between side surfaces of gear wheels and covers, or that of the radial clearance between tooth crests and the casing raceway can occur (Fig. 5).

DETERMINATION OF THE CLEARANCE BETWEEN CO-OPERATING ELEMENTS OF THE HYDRAULIC UNIT DURING ITS START-UP IN THERMAL SHOCK CONDITIONS

Changes of clearances between co-operating elements of the hydraulic unit during its start-up in the considered conditions depend on many factors : load, ambient temperature, oil temperature, oil flow rate.

Fig. 6 presents the following quantities : l_0 – geometrical clearance, l_m – assembling clearance, l_e – effective clearance. The geometrical clearance l_0 is determined by real dimensions of the co-operating elements. During the assembly of the hydraulic unit, the geometrical clearance l_0 becomes smaller due to elastic deformations of the elements, Δl_m , resulting from the assembling grip.

The effective clearance l_e depends on the assembling clearance l_m , elastic deformation Δl_p of the hydraulic unit elements, which results from the oil pressure action, as well as on the difference Δl_t in the linear thermal expansion of the elements co-operating within the subsystem.

$$l_e(\tau) = l_m + \Delta l_p(\tau) - \Delta l_t(\tau) \quad (1)$$

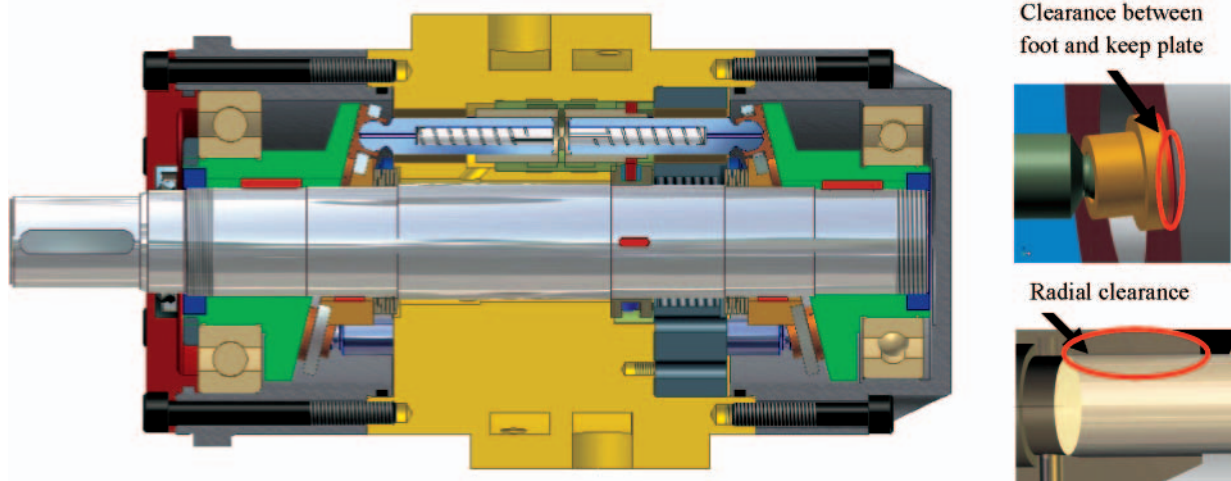

Fig. 4. PWK 27 axial piston pump [5] with indicated places between co-operating elements where the disappearance of the clearance can occur

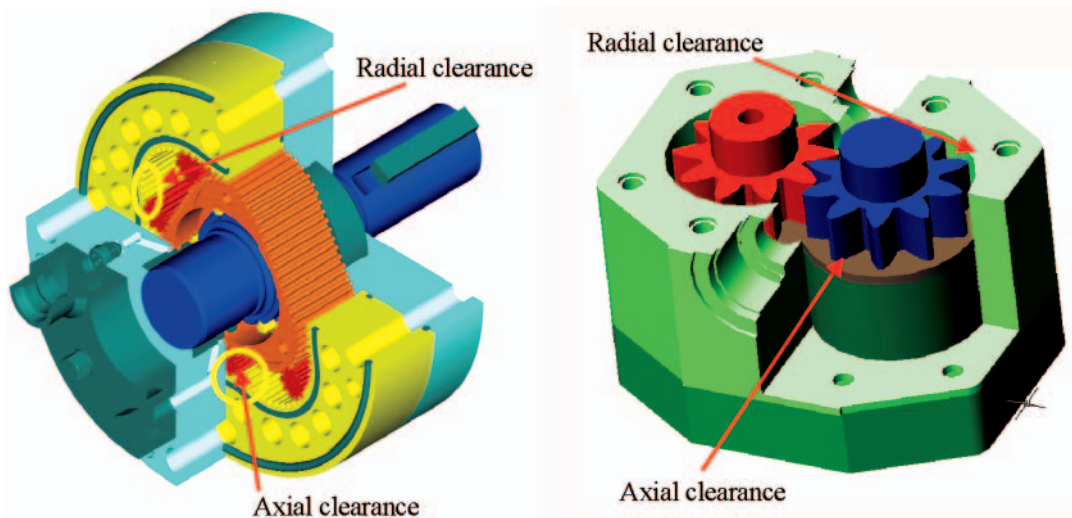

Fig. 5. SOK hydraulic satellite motor [9] with indicated places where the disappearance of axial clearance (between satellites and covers) or radial clearance (between satellite teeth and casing raceways) can take place, as well as a high-speed gear pump (motor) with indicated places which are sensitive to thermal shock conditions

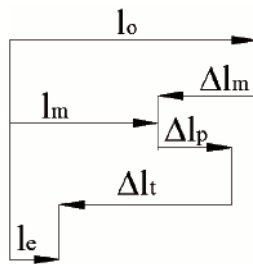

Fig. 6. Dimensional analysis for determining the effective clearance between co-operating elements of hydraulic unit under thermal shock conditions

The pressure contributes to the increase of the clearance. The higher the pressure in unit chambers, the greater increase of the effective clearance resulting from the elastic deformation of the elements of the hydraulic unit, $\Delta l_p(\tau)$, when it is supplied with the oil in thermal shock conditions.

The author of the present article has elaborated a method for assessing changes of the clearance l_e in the considered starting conditions [2, 3].

LABORATORY STAND FOR TESTING HYDRAULIC COMPONENT IN THERMAL SHOCK CONDITIONS

Experimental tests have been conducted to detect phenomena taking place during the start-ups of hydraulic component under thermal shock conditions [2, 3, 4].

The Chair's laboratory is equipped with, among other components, multi-pump supply devices fitted with oil temperature stabilization, devices for testing hydraulic component and systems, as well as the system for measuring and recording mechanical, hydraulic and thermal quantities.

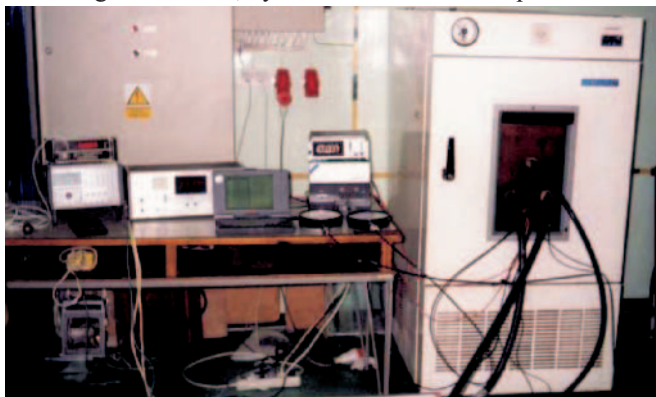

Fig. 7. Low-temperature chamber and measuring system installed in the laboratory of the Chair of Hydraulics and Pneumatics

The component were cooled down to the temperature of -38°C , the minimum, in the low-temperature chamber (Fig. 7). The tests were carried out without forced air circulation. The temperature T_1 of the oil supplying the motor was maintained within the range from 30°C to 60°C (usually at 50°C) using the oil temperature stabilization system.

During the start-up of the hydraulic unit the following quantities were measured: $p_1(\tau)$ – pressure at hydraulic unit inlet, $p_2(\tau)$ – pressure at hydraulic unit outlet, $Q(\tau)$ – oil flow rate, $n(\tau)$ – rotational speed of pump motor shaft, T_{ot} – temperature in the cold chamber, $T_1(\tau)$ – temperature at hydraulic unit inlet, $T_2(\tau)$ – temperature at hydraulic unit outlet, $T_1(\tau)$ – temperatures at selected points of elements of the tested component, $M(\tau)$ – torque.

The Advantech Visidac system was used for collecting the measured data in the computer-aided data transmission and recording system (Fig. 8).

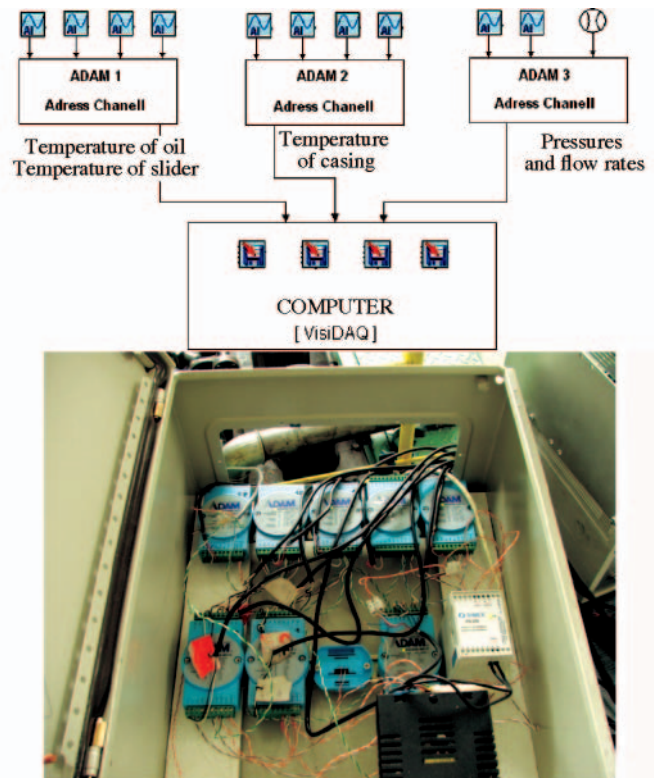

Fig. 8. System transmitting and recording the data collected from sensors

THE HYDRAULIC COMPONENT TESTED AT LOW AMBIENT TEMPERATURE

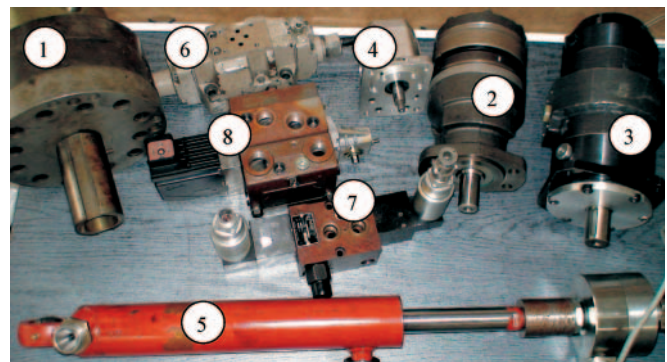

Fig. 9. Hydraulic component tested in low ambient temperature: 1 – SOK 100 satellite motor, 2 – TF 170 orbital motor, 3 – axial piston pump PWK 27, 4 – gear pump, 5 – hydraulic cylinder; the valve: 6 – 4WEH16C33/6AW220-50, 7 – RE2510/101 and 8 – PVG 32 proportional valve

In the laboratory of the Chair of Hydraulics and Pneumatics, a number of hydraulic component were tested in thermal shock conditions [2, 3], including:

- ✦ the satellite motors: SOK 100 and SOK 160 made by ZUO HYDROSTER (Fig. 9)
- ✦ the orbital motors: GMR 160 made by REXROTH, and TF 170 made by PARKER (Fig. 9)
- ✦ PZ-2-K-10 gear pump of external meshing, which operated as a motor, made by HYDROTOR
- ✦ PZ-2-K-6,3 gear pump of external meshing, made by HYDROTOR (Fig. 9)
- ✦ PWK 27 axial piston pump made by HYDROTOR (Fig. 9)
- ✦ PV 16 axial piston pump made by PARKER
- ✦ RK2-12 radial piston pump made by LUKAS
- ✦ CJ2F-50/28/250 hydraulic cylinder made by AGROMET ZEHS, Lubań (Fig. 9)

- ✦ CJ2F-50/28/250 hydraulic cylinder made by STALKO
- ✦ RE2510/101 electro-hydraulically controlled valve made by HYDROTOR
- ✦ 4WEH16C33/6AW220-50 two-stage valve made by REXROTH (Fig. 9)
- ✦ PVG 32 proportional valve made by SAUER DANFOSS (Fig. 9)
- ✦ UZPP16 indirect-action overflow valve made by PONAR WADOWICE
- ✦ 4WS2EM10 - 45 / 20B2T315Z8EM servovalve made by BOSCH REXROTH.

All these hydraulic component were supplied with the mineral oil Total Azolla 46.

SYMPTOMS WHICH INDICATE CORRECT OR INCORRECT OPERATION OF A HYDRAULIC MOTOR DURING ITS START-UP IN THERMAL SHOCK CONDITIONS ON THE BASIS OF PRESSURE AND ROTATIONAL SPEED TIME-HISTORIES

In the tests of hydraulic unit start-ups in thermal shock conditions three characteristic parameters were changed, which were the oil flow rate, the hot oil temperature, and the initial temperature of the cooled-down motor. Depending on the value of the oil flow rate Q and the temperature difference ΔT_{ol-ot} between the hot oil and the cooled-down motor at the initial instant, three areas of starting parameters at which the motor will operate either correctly, or temporarily incorrectly, or completely incorrectly, can be named (Fig. 10).

Figs 11 through 14 show typical time-histories of changes of parameters of hydraulic motor operation during its start-up in thermal shock conditions. On the basis of these time-histories the areas of parameters ($Q, \Delta T_{ol-ot}$) of correct and incorrect motor operation can be determined.

Determination of correct or incorrect operation of a hydraulic motor during its start-up in thermal shock conditions on the basis of pressure and rotational speed time-histories

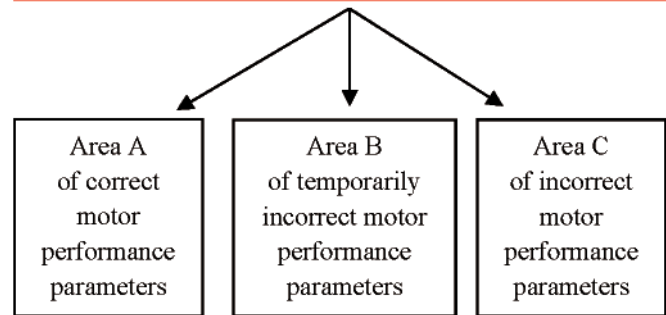

Fig. 10. Areas of starting parameters of hydraulic motor

Fig. 11 shows sample time-histories of correct motor start-ups which represent the area A in Fig. 10. During these start-ups no symptoms of incorrect motor operation, e.g. no pulsating changes of oil pressure or rotational speed, were observed.

The diagrams shown in the next figure, Fig. 12, illustrate the temporarily incorrect start-up of the motor, area B in Fig. 10, during which certain symptoms, such as transient increase of oil pressure at motor inlet, accompanied by imperceptible rotational speed changes, were recorded.

A sample of incorrect motor start-up in the area C is shown in Figs 13 and 14. During this start-up such symptoms as changes of oil pressure and rotational speed appeared for the critical period only, or irreversibly at all. The motor operated incorrectly for some time, i.e. for the critical period only (Fig. 13), as for a number of seconds the clearance between motor elements was reduced to zero, which resulted in pressure

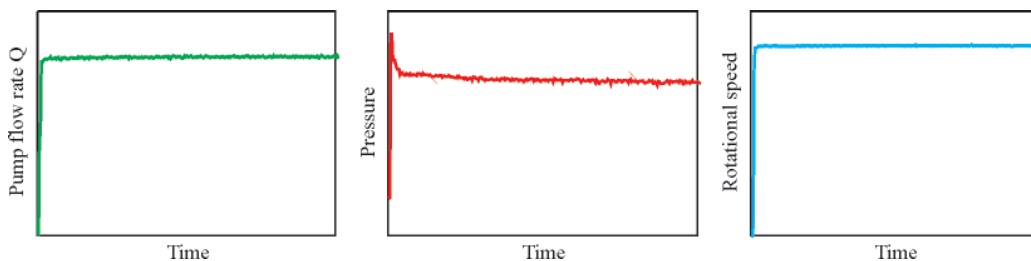

Fig. 11. Time-histories of parameters characteristic for correct motor operation (area A in Fig. 10)

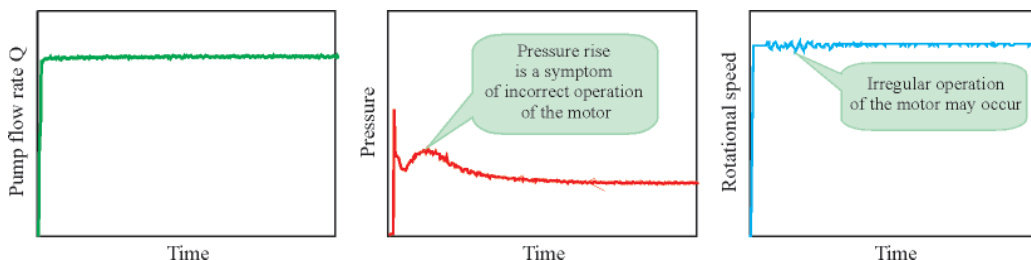

Fig. 12. Time-histories of parameters characteristic for temporarily incorrect motor operation (area B in Fig. 10)

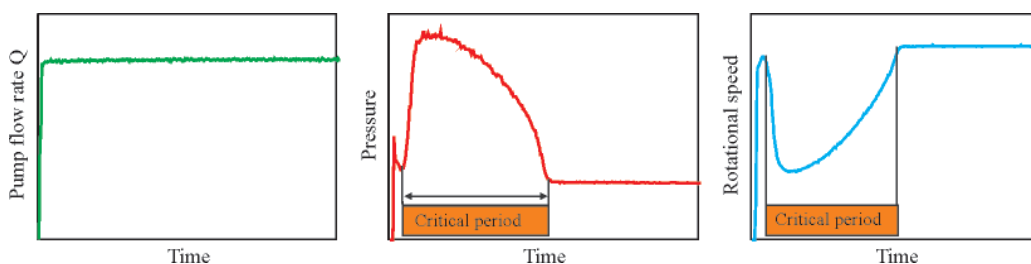

Fig. 13. Time-histories of parameters characteristic for incorrect motor operation (area C in Fig. 10)

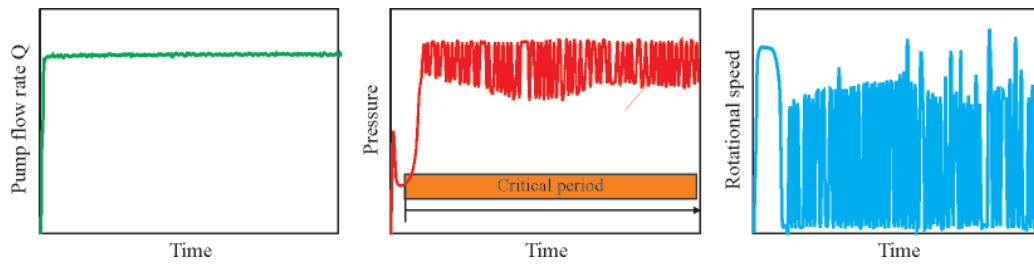

Fig. 14. Time-histories of parameters characteristic for incorrect motor operation (area C in Fig. 10).
Note: in this case only cutting off the oil supply to the motor terminated the critical period of motor operation

rise and rotational speed drop. After that period the motor returned to correct operation.

Fig. 14 illustrates the situation of permanently incorrect motor operation, including possible motor stop or irregular operation. During the irregular motor operation (Fig. 14), a critical period is observed which lasts until the oil supply to the motor is cut off. During this period stepwise changes of inlet pressure and rotational speed, and short-lasting motor stoppages occur.

SAMPLE SYMPTOMS WHICH INDICATE INCORRECT OPERATION OF THE HYDRAULIC MOTOR

Results of the tests done on the SOK 100 satellite motor (see Fig. 5, item 9) whose working elements move between side plates with the clearance l_c , are presented as a sample case. In several start-up tests with the SOK 100 motor, incorrect motor operation was recorded during which the motor returned, after some time, to its normal (correct) operation. One of such start-ups occurred for the following values of the parameters: $Q = 100 \text{ dm}^3/\text{min}$, initial motor temperature equal to -20°C , oil temperature equal to 50°C . Fig. 15 shows the oil pressure time-histories recorded in the supply and outflow manifolds during incorrect operation of the SOK 100 motor.

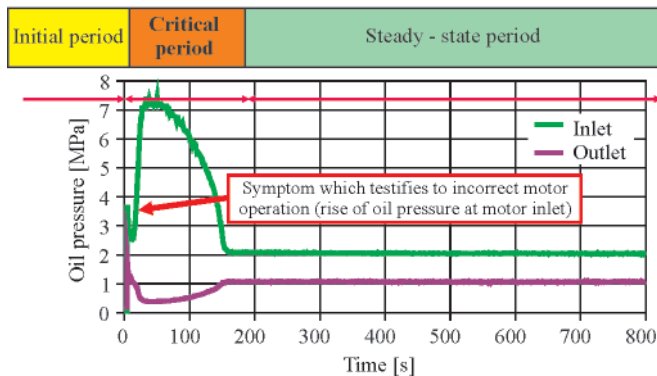

Fig. 15. Oil pressures at motor inlet and outlet:
cold chamber temperature $t_{ot} = -20^\circ\text{C}$,
oil temperature $t_{ol} = 50^\circ\text{C}$, oil flow rate $Q = 100 \text{ [l/min]}$

As results from the oil pressure time-history (Fig. 15), after 18 seconds from the start-up the motor revealed symptoms of incorrect operation: the oil pressure at motor inlet suddenly rose up to 7.2 MPa. The incorrect motor operation lasted for about 150 seconds.

In the start-up time-history of the motor revealing symptoms of incorrect operation the following three periods can be named (Figs. 13 and 15):

- ☆ *initial period*: for a few seconds the motor operation was correct, the motor monotonously speeded up and only after a number of seconds its operation became irregular
- ☆ *critical period*: after ten to twenty seconds the incorrect motor operation was observed (oil pressure rise and rotational speed drop)

- ☆ *steady-state period*: after the critical period the motor operation became stable again, i.e. its rotational speed became steady and the oil pressures at motor inlet and outlet stabilised.

The situation observed during the SOK 100 motor start-up tests performed in the conditions of the ambient temperature $t_{ot} = -15^\circ\text{C}$, the oil temperature $t_{ol} = 53^\circ\text{C}$, and the oil flow rate $Q = 100 \text{ [l/min]}$ (Fig. 16), was quite different.

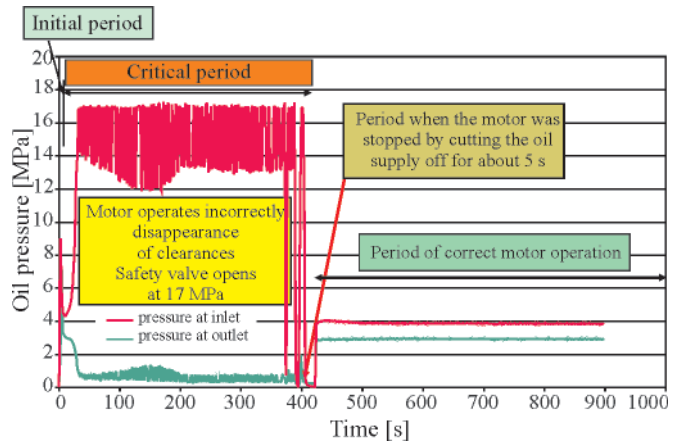

Fig. 16. Oil pressures at motor inlet and outlet:
cold chamber temperature $t_{ot} = -15^\circ\text{C}$,
oil temperature $t_{ol} = 53^\circ\text{C}$, the oil flow rate $Q = 100 \text{ [l/min]}$

In these conditions the operation of the motor was incorrect. During the start-up the motor did not come back to correct operation. As the incorrect operation period could last longer, the oil supply was cut off.

During the initial period (Fig. 16) the oil pressure rises in a stepwise mode up to about 9 MPa, then it drops to 5 MPa for a few seconds and again rises suddenly up to the safety valve opening pressure equal to 17 MPa. Until then the motor operates incorrectly. Sudden pressure changes occur within the range from 13 to 17 MPa. The high pressure (17 MPa) provokes the deformation of covers and increases the axial clearance. In these conditions the moving elements of the motor are free to rotate until the pressure drop, after which the deformation of plates decreases which can lead to complete disappearance of the clearances. The lack of clearance between the co-operating elements increases the friction and, consequently, stops the motor. Then the oil pressure in the working chambers rises and the clearance increases. The above described situation was recorded up to second 406. After this time the oil supply to the motor was cut off. After starting the motor again it began to operate correctly after about 5 s.

The time duration of the above described phenomena is affected by the scale of the stepwise rises of the oil flow rate, and the difference between the ambient temperature and that of motor elements.

In the considered case of incorrect motor operation only two characteristic periods were observed:

- ⇒ initial period
- ⇒ critical period.

In the critical period full reduction of clearances took place, accompanied by the increase of the friction between co-operating motor elements. As a consequence, mechanical seizing of motor elements was observed. The temperature difference was so high that particular elements became heated-up after different periods. The safety valve protected the motor against complete damage.

Fig. 17 shows noticeable traces of failures formed during the SOK 100 motor start-up with symptoms of incorrect operation in thermal shock conditions.

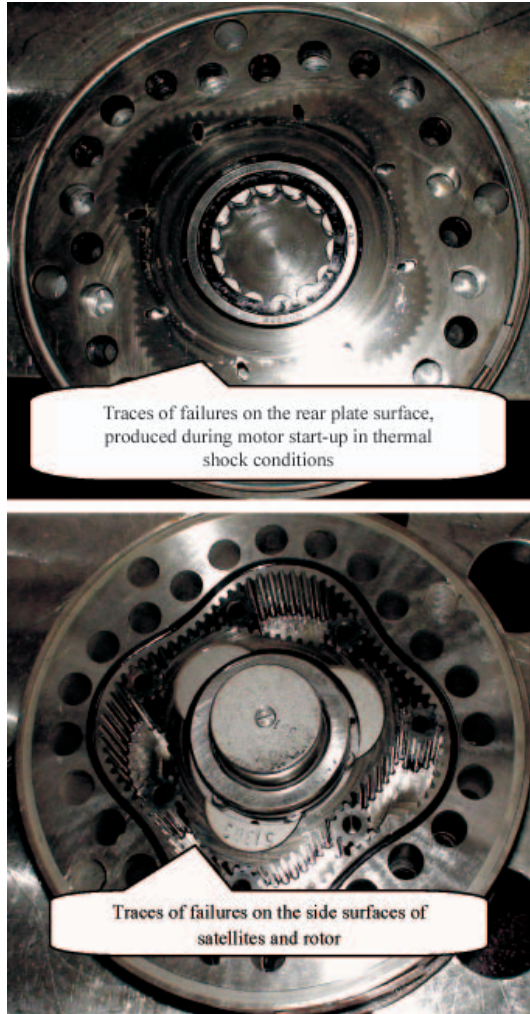

Fig. 17. Traces of failures formed during SOK 100 motor start-up with symptoms of incorrect operation in thermal shock conditions

AREAS OF STARTING PARAMETERS OF SELECTED HYDRAULIC COMPONENT IN THERMAL SHOCK CONDITIONS

On the basis of the tests of SOK 100 satellite motor (Fig.18), GMR 160 orbital motor (Fig.19), PWK 27 pump (Fig. 20), and RE2510/101 valve (Fig. 21) the areas of their starting parameters were determined. They are defined by stepwise increase of oil flow rate and difference between oil temperature and that of the hydraulic unit at the initial instant.

It was assessed that the SOK 100 satellite motor (Fig. 5, item 9) having axial clearance of 23 μm can operate correctly (Fig. 18) at the temperature difference between the oil and the cooled-down motor equal to 55 $^{\circ}\text{C}$ and

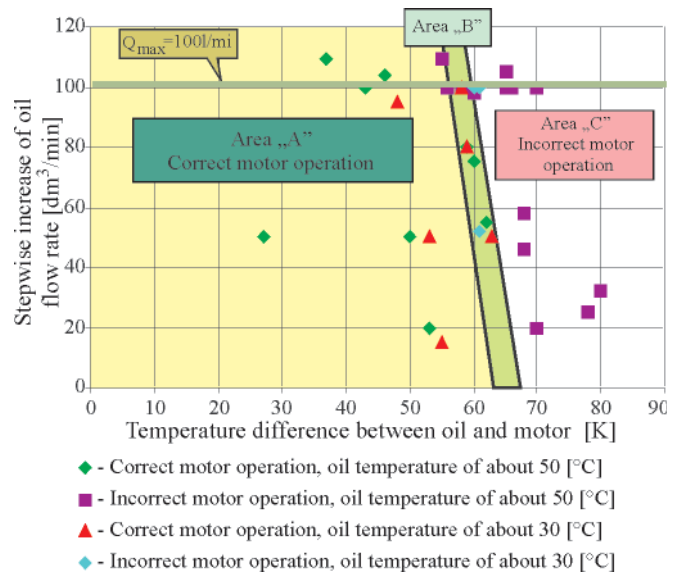

Fig. 18. Areas of operating parameters of SOK 100 satellite motor in thermal shock conditions

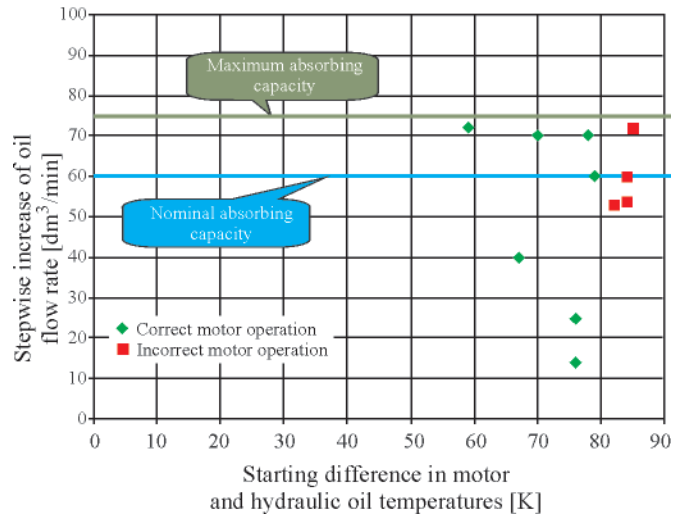

Fig. 19. Starting parameters of GMR 160 motor in thermal shock conditions

the maximum oil supply flow rate. Motor start-ups at higher temperature differences may completely reduce the clearance and lead to the failure of the motor and the entire hydraulic device. The transient area „B” (Fig. 18) is inclined by a small angle to the vertical axis. As a result, the smaller the stepwise change of the flow rate, the higher the possible initial difference between oil and motor temperatures (area A) at which the motor is still able to operate correctly.

The GMR 160 orbital motor having the axial clearance of 40 μm and the radial one of 28 μm is more resistant to thermal shock conditions, as it appeared to operate correctly at the temperature difference up to 78 K and nominal oil flow rate (Fig. 19).

The tests of the PWK27 pump have revealed that during the start-up it operated incorrectly in some conditions. It was the case when the start-up was carried out at the pressure on the delivery side of the pump, equal to about 5 MPa, and the rotational speed exceeding 1500 rpm (Fig. 20). During the initial period of the pump start-up its incorrect operation was manifested by instantaneous lack of hydrostatic unloading in the area of co-operation of the hydrostatic foot and the keep plate. The incorrect operation of the PWK 27 pump in thermal shock conditions can be avoided by the use of an appropriate valve located behind the pump, in order to raise its pressure up to 5 MPa at least.

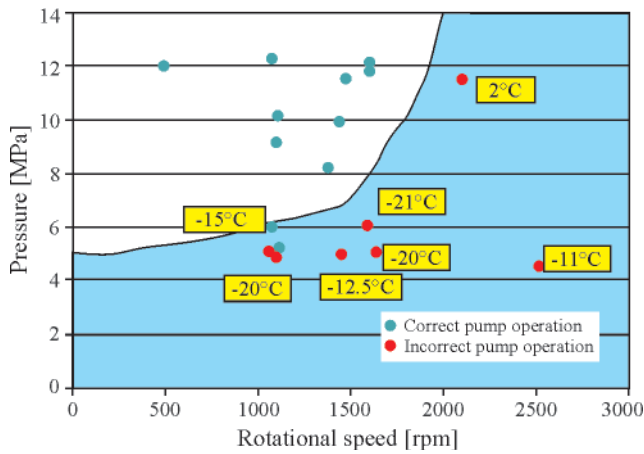

Fig. 20. Starting parameters of PWK27 pump in thermal shock conditions

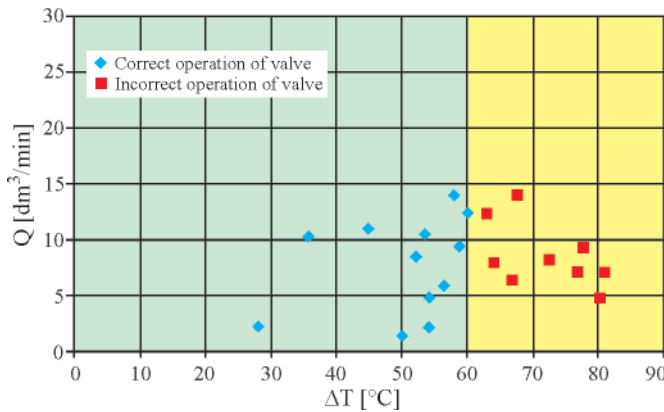

Fig. 21. Range of operation of RE2510/101 valve as a function of oil flow rate and temperature difference between oil and valve

The RE2510/101 valve is not resistant to the operation in thermal shock conditions at the temperature difference between oil and valve, $\Delta T_{\text{ol-ot}}$, higher than 62 °C (Fig. 21). The diameter of the valve slider was equal to 18 mm and the initial clearance between the slider and the casing was equal to 6 μm , according to the measurements performed by the Metrology Laboratory, Gdańsk University of Technology.

CONCLUSIONS

- The clearance between the co-operating elements is the main constructional factor which affects the operation of a hydraulic unit in thermal shock conditions. Due to the heat exchange process, moving elements of the unit are heated faster by the flow of hot oil than the casing (motionless element). Different linear deformations of particular elements are the reason why the effective clearance may be reduced to zero during unit heating. The lack of clearance results in the appearance of dry friction between the moving and motionless elements. As a result, the produced heat is directly transferred to the elements. The temperature of the moving elements suddenly increases, which makes their dimensions even bigger. During this time the moving elements rotate irregularly, thus causing permanent failures of both the moving and motionless elements.

- The phenomena which most affect the operation of the component in thermal shock conditions occur during the first two minutes of the start-up process.
- The process of hydraulic motor damage can be prevented by prompt cut-off of the oil supply to the motor.
- The performed tests of hydraulic component in thermal shock conditions showed the way in which a given unit may behave in extreme conditions of operation.
- Some of the tested component turned out to be unserviceable at the temperature differences slightly exceeding 50 °C. It was also stated that the same component, but manufactured with greater clearances, were capable of operating at higher temperature differences. However, the operation of such a unit would be associated with its lower efficiency.
- The parameters of hydraulic motor which are crucial for the appearance of incorrect motor operation include stepwise oil flow rate, oil temperature, and initial temperature of the motor.
- The discussed problems should be taken into account when designing hydraulic component and systems which are to be used for driving devices and machines in low ambient temperatures.

BIBLIOGRAPHY

1. Balawender A.: *Energy analysis and testing methods of low-speed hydraulic motors* (in Polish). Zeszyty naukowe PG (Scientific Bulletins of Gdansk University of Technology), Gdańsk 1988.
2. Jasiński R.: *Operation of low-speed hydraulic motors in thermal shock conditions* (in Polish). Doctoral thesis, Gdańsk 2002.
3. Jasiński R.: *Experimental tests of PWK 27 axial multi-plunger pump of Hydrotor firm in low ambient temperatures* (in Polish), „Napędy i sterowanie” No. 4/2008
4. Jasiński R.: *Methods of determination of correct operation area for hydraulic component in low ambient temperatures*. Developments in Mechanical Engineering, Gdańsk 2008
5. Osiecki A.: *Hydrostatic drive of machines* (in Polish). Wydawnictwo Naukowo-Techniczne (Scientific Technical Publishing House), Warszawa 1998
6. Polish Standardization Office: PN-86/M-73079 - *General conditions of using the uniform hydraulic system* (in Polish)
7. Polish Register of Shipping: *Publication No. 11P* (in Polish), Gdańsk 1994
8. Polish Register of Shipping: *Environmental tests of ship equipment* (in Polish). Gdańsk 1975
9. Hydroster Ship Equipment Works: *Technical information and documentation of SOK 1 hydraulic motors* (in Polish). Gdańsk
10. Bosch Rexroth: *Product catalogues*
11. Liebherr: *Product catalogues*.

CONTACT WITH THE AUTHOR

Ryszard Jasiński, Ph. D.
Faculty of Mechanical Engineering
Gdansk University of Technology
Narutowicza 11/12
80-952 Gdansk, POLAND
e-mail: rjasinsk@pg.gda.pl