

R. Aranowski^{*}, J. Hupka^{*}, Ch. Jungnickel^{*}

CHANGES IN RHEOLOGICAL PROPERTIES DURING ANAEROBIC DIGESTION OF ACTIVATED SLUDGE

Received July 1; reviewed; accepted July 27, 2009

The measurements of rheological properties of activated sludge suspension after mechanical disintegration indicate a substantial decrease in viscosity of up to 60%. Together with the decrease of viscosity pseudoplastic properties increased and the flow limit dropped. Similarly, significant changes of rheological properties occurred in the sludge, subjected to methane fermentation. One can observe that the length of fermentation period influences the decrease in viscosity of the sewage sludge. It is postulated to use the measurement of viscosity for the estimation of excessive sludge disintegration ratio as this method is much faster than determination of COD.

key words: rheological properties, activated sludge, anaerobic digestion, rheology, sludge disintegration

INTRODUCTION

Due to substantial deviations from Newtonian properties occurring during the flow of sewage sludge, hydraulic transport ought to take place only for well defined rheological properties. Lack, or insufficient amount of information can lead to too fast damage of plumbing fittings and pipes and in particular cases resulting in dangerous accidents. Also, of utmost importance is the information on rheological properties of sludge at the stage of designing new sewage treatment systems.

Currently, numerous sewage treatment plants apply systems decreasing the amount of formed sludge through methane fermentation. With regard to a substantial

^{*} Department of Chemical Technology, Gdansk University of Technology, ul. Narutowicza 11/12, 80-952 Gdansk, Poland, e-mail: aran@chem.pg.gda.pl

concentration of dry matter in condensed sludge fed to fermentation chambers, the transport process at this stage is of crucial importance for the whole sewage treatment process.

With respect to complex composition of sewage sludge its properties undergo continuous changes during treatment as well as methane fermentation process. Hence, the knowledge of rheological properties changes that occur during transport and fermentation process allows for optimization of the choice of pumps and mixers. These elements are of crucial importance for correct working of closed fermentation chambers (Baudez, 2006) and dewatering process (Gilles et al., 2005, Örmeci, 2007).

Activated sludge has pseudoplastic properties indicating the presence of thixotropic behavior (Moeller, Torres, 1997, Mori et al., 2006, Pham et al., 2009). One can also find numerous contradictory opinions proving that activated sludge has both Newtonian and non Newtonian properties. The presence of hysteresis on flow curves is most frequently explained by disintegration of internal structure of liquid suspension as a result of the operation of shear stress. As a consequence there is an assumption that the higher the initial peak, the bigger force must be applied to overcome the internal structure and the bigger the hysteresis loop the longer must be the deformation of the liquid in order to achieve the steady state. When the forces acting on the liquid are removed, the structure of the liquid should be restored, however, there is documentation which does not confirm the occurrence of this phenomenon. Thus, irreversible disintegration of internal structure of the liquid must be explained differently. As it was proved by Magnin and Piau (1990) as well as Greener and Connely (1986) the viscoelastic effect can produce a substantial hysteresis on flow curves. In the research of rheology of polymers one can find information explaining the presence of initial peak. It is the transition from elastic to viscous phase. As proved by Mujumdar and coauthors (Mujumdar et al., 2002), sewage sludge exhibit a non-Newtonian behaviour characterized by three domains: a linear viscoelastic part below a first critical shear stress, then an intermediate regime and beyond a second critical stress, a purely viscous part.

MATERIALS AND METHODS

FERMENTATION AND DIGESTION PROCEDURE

The process of mesophilic methane fermentation was carried out in a mobile installation. For the tests two 600 dm³ containers filled with 300 dm³ of biomass were used. The installation diagram is presented in Fig. 1.

The process of fermentation was initiated by filling fermentation chambers with 300 dm³ of biomass composed of 60% of primary sludge and 40% of thickened excessive sludge from municipal waste water treatment plant in such a way that the

content of dry matter in the mix was 3%. The method of periodical feeding of biomass to fermentation chambers (once every 24 hours) in the amount of 5% of the volume of the fermentation chamber (15 dm^3) has been applied. Prior to feeding the new portion of sludge 15 dm^3 of fermented biomass was removed from the lower part of reactors.

The mix was fed via circulating pumps to the upper part of the reactor flowing through the heater and mixing with the content of the reactor. The recirculation pump sucked in the biomass from the lower part of the reactor and after heating in the heat exchanger it was fed to the upper part of the reactor. The average number of exchanges varied between 100 and 150 per 24 hours.

The fermentation process temperature was regulated by heating system with total power of 12 kW with the accuracy of $\pm 1.0^\circ\text{C}$. The heating system was integrated with the mixing system of circulating pump.

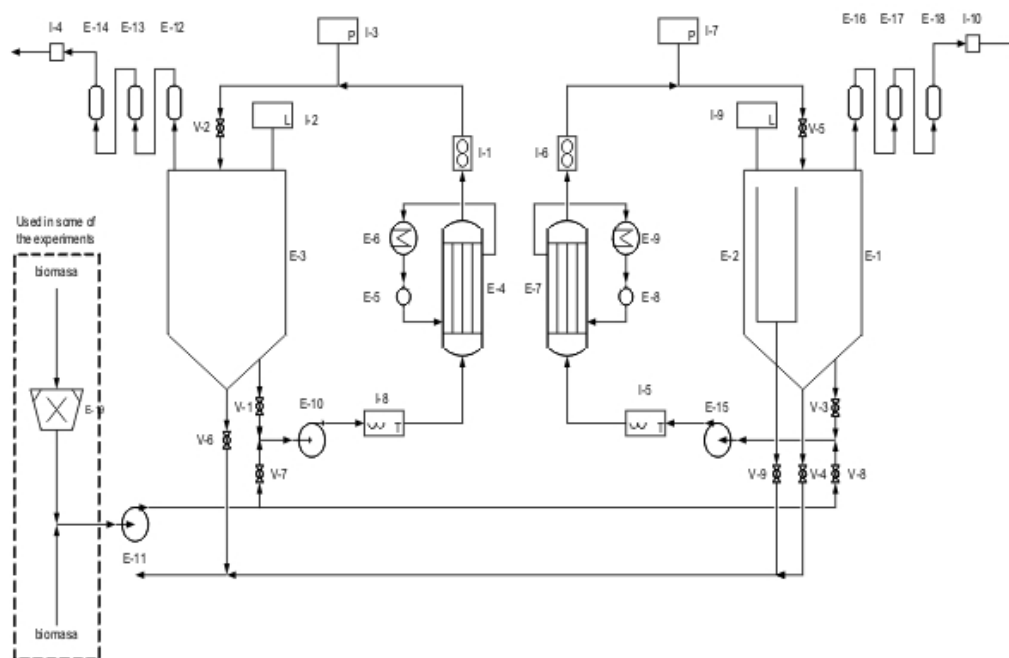

Fig. 1. Anaerobic digestion process flowsheet; E-1 - bioreactor Z2; E-2 internal tank; E-3 - bioreactor Z1; E-10, E-11, E-15 - centrifugal pump; E-12, 14, 16, 17, 18 - washer; E-4,5,7 - heat exchanger; E-5,8 - recirculation pump; E-6,9 - electric heater; E-19 - pump with fragmentize; V-1÷9 - valve; I-1,6 - flow meter; I-2,9 level meter; I-3,7 - manometer, I-5,8 - temperature sensor; I-4,10 - volume meter

Another series of experiments performed to fermentation of sludge with underwent mechanical disintegration in a centrifugal pump equipped with fragmentize. The power of the pump was 500 W. Only the excessive sludge was subject to disintegration. 30 dm^3 of excessive sludge was subject to one pass disintegration. The estimation of disintegration ratio was performed with by means of (DD_{COD}) method (Eq. 1.).

$$DD_{COD} = \frac{COD_D - COD_0}{COD_{NaOH} - COD_0} \cdot 100\% \quad (1)$$

where:

COD_0 - COD of supernatant before dezintegration

COD_D - COD of supernatant after dezintegration

COD_{NaOH} - COD of supernatant after dezintegration with 0.5 molar NaOH (22 hours at 20 °C).

RHEOLOGICAL MEASUREMENTS

Rheological measurements of sludge were performed using rotation rheometers Brookfield LVDV II+ and Rheotest II fitted with measuring system of coaxial cylinders. Prior to measurements, viscometers were calibrated with the Brookfield standards of viscosity. The rheological measurements were carried out in the temperature of 25 °C, and the examined samples were thermostated over 20 min before measuring with the accuracy of ± 0.1 °C. The flow curves were made by the increase of shear rate to the maximum value for which the measurement of shearing stress was still possible, subsequently the shear rate was decreased. For each rate the sample was stressed for 1 min.

Among numerous rheological models the involutive model is broadly applied (Eq. 2.).

$$\tau = k\dot{\gamma}^n \quad (2)$$

where dynamic viscosity can be derived at from the following equation (3)

$$\eta = \frac{\tau}{\dot{\gamma}} = k(\dot{\gamma})^{n-1} \quad (3)$$

where: η - apparent viscosity [Pas], τ - shear stress [Pa], $\dot{\gamma}$ - shear rate [s^{-1}], k consistency coefficient of fluid [$Pa \cdot s^{-1}$] (greater value of k the more viscous the fluid), and n is the flow behavior index, which is a measure of the degree of deviation from the Newtonian fluid behavior.

Depending on the value of n , the power law describes three flow behaviors. These behaviors include pseudoplastic ($n < 1.0$) – effective viscosity decreases with shear rate, Newtonian ($n = 1.0$) – the viscosity does not change with the shear rate and dilatants ($n > 1.0$) - the viscosity increases with the shear rate. However, due to visible flow limit for the description of rheological properties Herschel-Bulkley model (Tixier et al., 2003, Gilles et al., 2005) has been applied (Eq. 4)

$$\tau = \tau_0 + K_h(\dot{\gamma})^n \quad (4)$$

where: τ_0 - yield strength [Pa].



RESULTS AND DISCUSSIONS

RHEOLOGICAL BEHAVIOR OF ACTIVATED SLUDGE

Rheological properties of sludge are complex and dependent on numerous factors. Sewage sludge apart from mineral constituents also contains a substantial part of organic substances with majority of microorganisms. The complexity of biological structures poses significant difficulties in description of rheological properties of sewage sludge. As demonstrated by Baudez (2006), the application of traditional parameters, such as flow curves and departure cycles are not sufficient for characterization of thixotropic properties of sludge. Rheograms of mixture of excessive and primary sludge (Fig. 2) have peak at low shear speed and hysteresis loop, which indicates the thixotropic characteristics of sludge and the presence of strong internal structure of the suspension. Table 1 shows basic physical and chemical data of sludge subjected to fermentation.

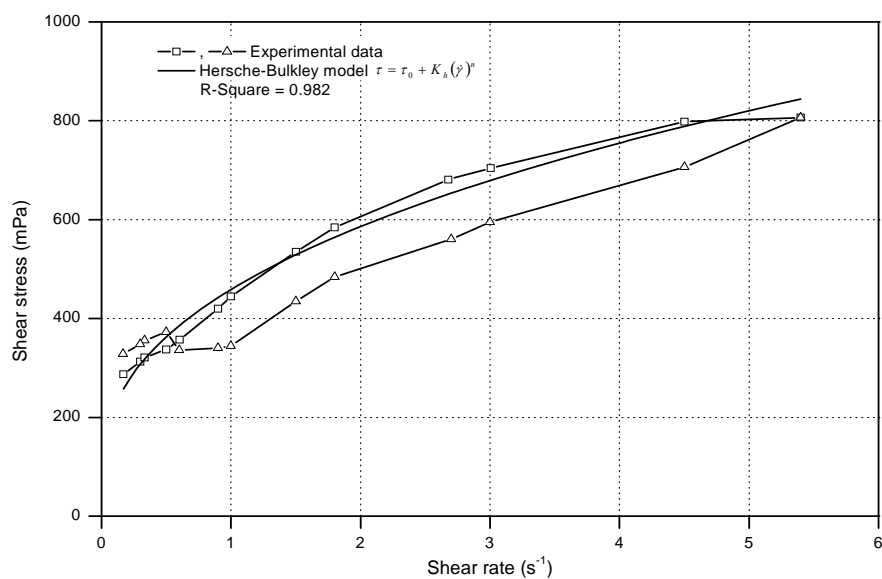

Fig. 2. Flow curve of mixture of activated sludge fed to bioreactors

Table 1. Physical and chemical parameters of sludge fed to bioreactors

Determination	Unit	Value
Alkalinity	pH	6.38
Volatile fatty acids	mval/dm ³	13.6
COD	mgO ₂ /dm ³	1684
COD	mgO ₂ /g d.m.	795.968
Dry mass	%	5.01
Calcination loss	%	76.5

EFFECT OF MINERAL PARTICLES CONTENT ON RHEOLOGICAL PROPERTIES OF SLUDGE

During anaerobic fermentation a series of biochemical processes occur in which organic matter yields mainly methane and carbon dioxide. As a result of these processes there occurs the decrease in the amount of solids in the sludge especially those of organic nature. It has decisive influence on changes of rheological properties of fermenting sludge. As presented in Fig. 3 viscosity and pseudoplasticity of sludge decreases as fermentation proceeds, which is most frequently explained by the significant influence of the content of solids. In Fig. 4 the exponential relationship of viscosity and the content of solid particles are clearly visible. In the literature one can encounter other methods of presenting the relationship between rheological properties and the content of solids, however, all unequivocally indicate that Einstein's equation ought not to be applied (Pevero et al., 2007; Seyssiecq et al., 2008). According to assumptions of Einstein's theory this equation describes mixtures of solid particles content above 10% v/v for systems without intermolecular interaction. Table 1 presents the changes of physical and chemical parameters of sludge during fermentation process. According to Sanin (2002), rheological properties of sludge can be influenced by reaction, however, in this case pH changes are minimal.

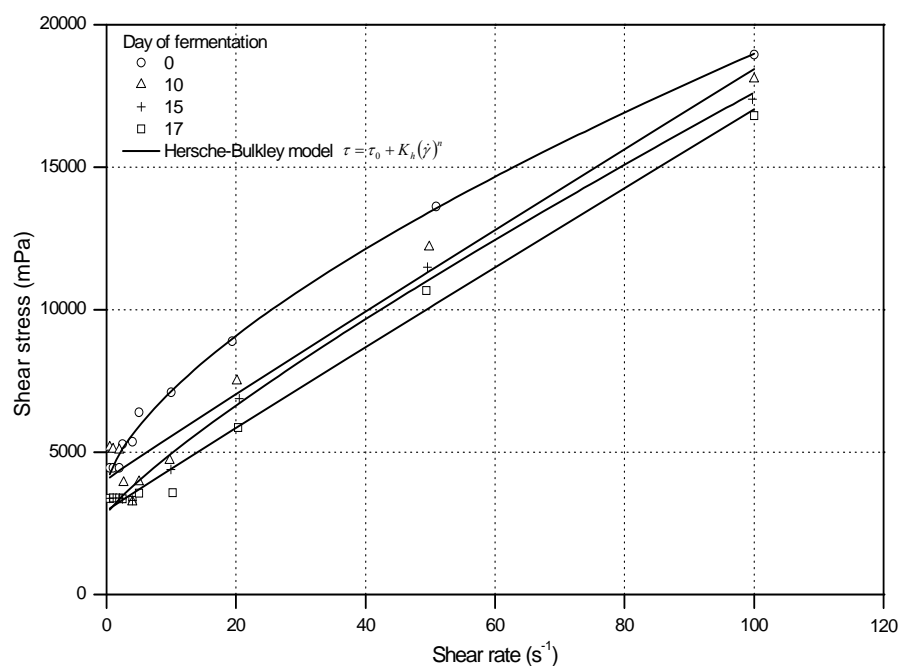

Fig. 3. Rheological character of fermented sludge vs the content of solids



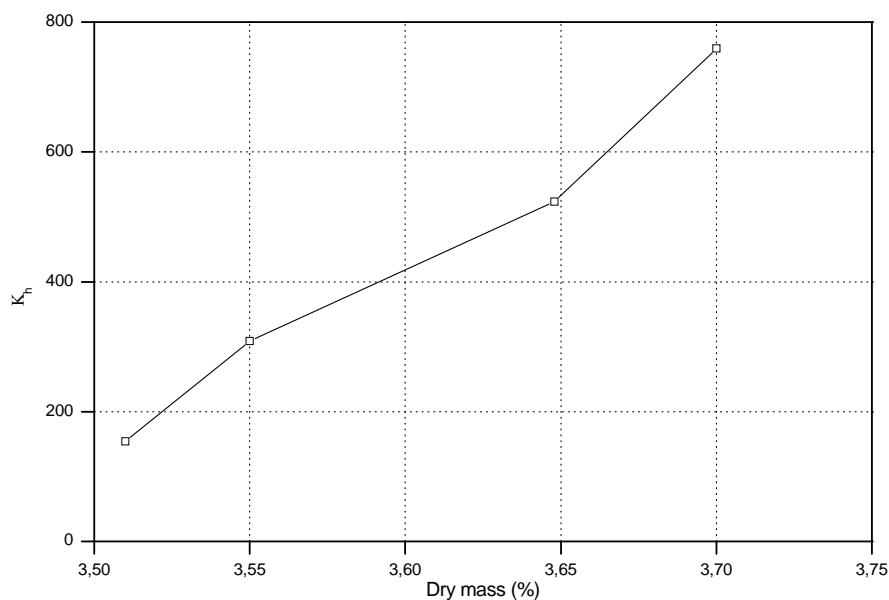

Fig. 4. Consistency ratio vs. content of solids

Table 2. Changes of physical and chemical properties of sludge during fermentation process

Determination	Unit	Day of anaerobic digestion			
		0	10	15	17
Alkalinity	pH	6.75	6.92	7.13	7.06
Volatile fatty acids	mval/dm ³	32.0	39.2	48/6	45.2
COD	mgO ₂ /dm ³	25333	19200	22266	24933
COD	mgO ₂ /g d.m.	790.41	648.97	592.11	1379.30
Dry mass (d.m.)	%	3,70	3,66	3,55	3,51
Calcination loss	%	70.45	69.12	71.42	71.04

EFFECT OF SLUDGE DISINTEGRATION ON RHEOLOGICAL PROPERTIES

Disintegration of sewage sludge is an increasingly frequently used operation in connection with anaerobic fermentation. As a result of lysis of cells it is possible to achieve a significant increase of fermentation speed and decrease of content of organic matter. In the pilot tests mechanical disintegration carried out in the pump with a fragmentizer was applied. Figure 5 presents the dependence of disintegration degree (DD) on the time of the pump operation.

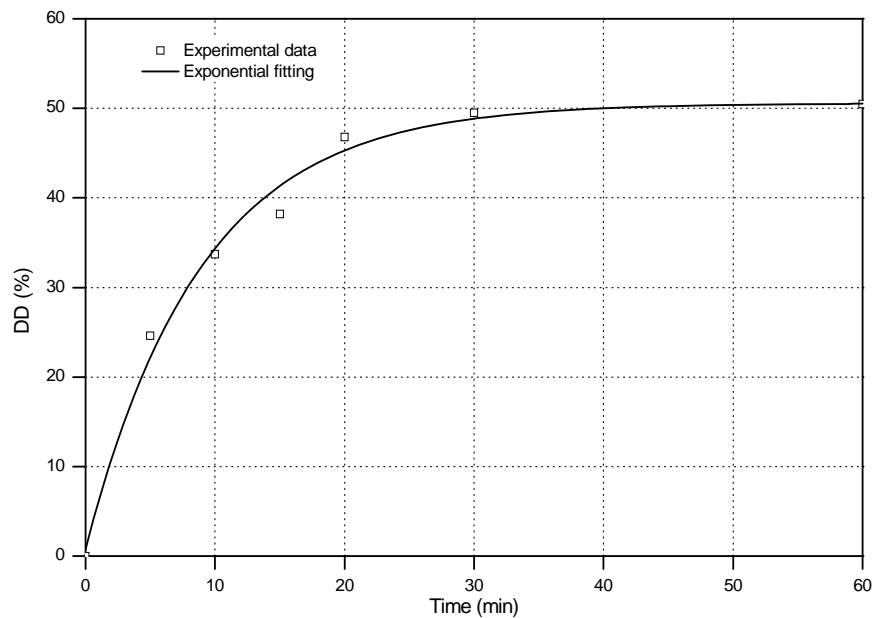

Fig. 5. Degree of disintegration of activated sludge vs. time of disintegration

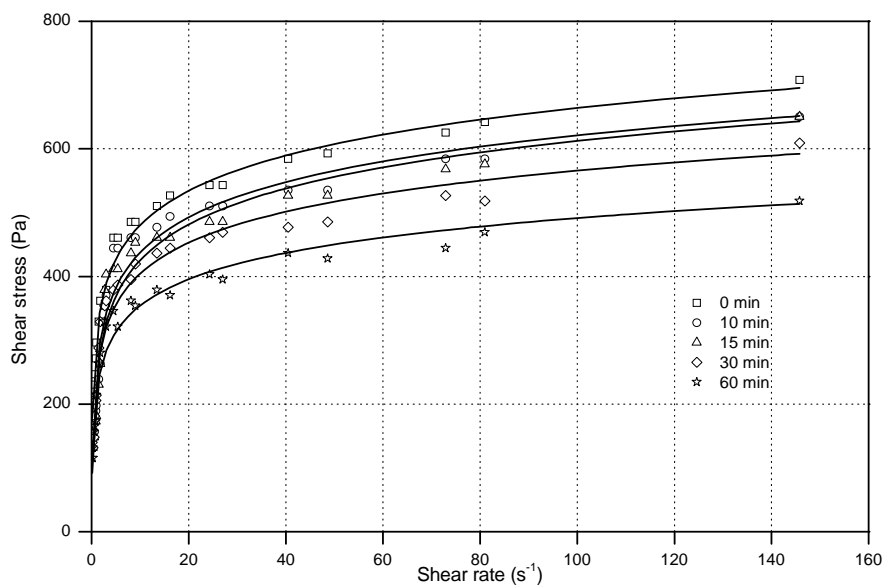

Fig. 6. Sludge flow curves subject to mechanical disintegration

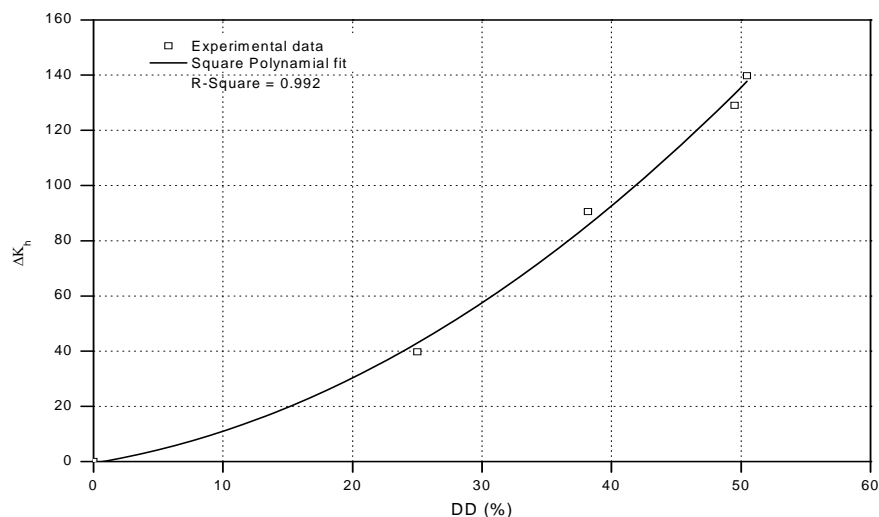

Fig. 7. Relative changes of consistence ratio to sludge disintegration degree

During disintegration the sludge samples were collected and they had rheological properties determined. As one can see in the Fig. 6 rheological parameters changed significantly during time of disintegration. Viscosity of sludge decreased and both pseudoplasticity and consistency ratio increased. The changes were so significant that they can be applied for a quick identification of disintegration degree on the basis of rheological properties measurements. Figure 7 shows a relative increase of consistency ratio due to disintegration degree.

CONCLUSIONS

As it results from the achieved rheograms, sewage sludge has flow limit and exhibits pseudoplasticity, which most often results from thixotropy of the system. Among numerous parameters influencing rheological properties, most significant is the content of solids. Pseudoplasticity of sludge increases together with the increase of solids content. Consequently, in the process of fermentation, as a result of decrease in the content of organic matter even by 60%, pseudoplasticity and consistency ratio increases.

Rheological parameters changes during disintegration of excessive sludge enable a quick estimation of disintegration degree. In comparison with the DD_{COD} method, viscosity measurement is considerably more environmentally friendly (no chemicals needed), cheaper and faster. In order to compare disintegration degree using viscosity measurement preparation of the calibration curve is necessary.



ACKNOWLEDGEMENTS

This research was supported by the Gdansk University of Technology, contract DS No. 014668/003.

REFERENCES

- BAUDEZ J-Ch., (2006) *About peak and loop in sludge rheograms*. Journal of Environmental Management 78: 232-239.
- DILEK SANIN F., (2002). *Effect of solution physical chemistry on the rheological properties of activated sludge*. Water SA 28 (2): 207-211.
- GREENER J., CONNELLY R.W., (1986). *The response of viscoelastic liquids to complex strain histories: the thixotropic loop*. Journal of Rheology 30 (2): 285-300.
- GUIBAUD G., TIXIER N., et al. (2005). Hysteresis area, a rheological parameter used as a tool to assess the ability of filamentous sludges to settle. Process Biochemistry 40: 2671–2676.
- MAGNIN A., PIAU J.M. (1990). *Cone and plate rheometry of yield stress fluids: study of an aqueous gel*. Journal of Non-Newtonian Fluid Mechanics 36: 85-108.
- MOELLER G., TORRES L.G., (1997). *Rheological Haracterization of Primary and Secondary Sludge Treated by Aerobic and Anaerobic Digestion*. Bioresource Technology 61: 207-211.
- MORI M., SEYSSIECQ I., et al. (2006). *Rheological measurements of sewage sludge for various solids concentrations and geometry*. Process Biochemistry 41: 1656–1662.
- MUJUMDAR A., BERIS A.N., et al. (2002). *Transient phenomena in thixotropic systems*. Journal Non-Newtonian Fluid Mechanics 102: 157-178.
- ÖRMECI B., (2007). *Optimization of a full-scale dewatering operation based on the rheological characteristics of wastewater sludge*. WATER RESEARCH 41: 1243-1252.
- PEVERE P., GUIBAUD G., et al. (2007). *Identification of rheological parameters describing the physico-chemical properties of anaerobic sulphidogenic sludge suspensions*. Enzyme and Microbial Technology 40: 547–554.
- PHAM T.T.H., BRAR S.K., et al. (2009). *Influence of ultrasonication and Fenton oxidation pre-treatment on rheological characteristics of wastewater sludge*. Ultrasonics Sonochemistry In press.
- SEYSSIECQ I., MARROT B., et al. (2008). *In situ triphasic rheological characterisation of activated sludge, in an aerated bioreactor*. Chemical Engineering Journal 142: 40-47.
- TIXIER N., GUIBAUD G., et al. (2003). *Determination of some rheological parameters for the characterization of activated sludge*. Bioresource Technology 90: 215-220.

Aranowski R., Hupka R., Jungnickel Ch., *Zmiany właściwości reologicznych podczas fermentacji metanowej osadu czynnego*, Physicochemical Problems of Mineral Processing, 44 (2010), 13-22, (w jęz. ang), <http://www.minproc.pwr.wroc.pl/journal>

Wykonane pomiary właściwości reologicznych osadów nadmiernych poddawanych procesowi dezintegracji mechanicznej wskazują na znaczny spadek lepkości sięgający 60%. Wraz ze stopniem dezintegracji rosły również właściwości pseudoplastyczne oraz malała granica płynięcia. Podobnie istotne zmiany właściwości reologicznych następowały w osadach poddawanych fermentacji metanowej. Z analiz pobieranych próbek po różnym okresie trwania procesu wynika, że czas fermentacji wpływa na zmniejszenie lepkości osadów ściekowych. Pomiar lepkości może być stosowany do oceny stopnia dezintegracji osadu nadmiernego, ponieważ metoda ta jest znacznie szybsza niż oznaczenie ChZT (analiza zalecana przez ATV).

słowa kluczowe: właściwości reologiczne, osad czynny, fermentacja metanowa, reologia, dezintegracja osadów

