

Comparison of Residual Current Devices Tripping Characteristics for Selected Residual Current Waveforms

S. Czapp

Gdansk University of Technology,

ul. Narutowicza 11/12, 80-233 Gdansk, Poland, e-mail: s.czapp@ely.pg.gda.pl

Introduction

According to the international standard [1] hazardous-live-parts of electrical devices shall not be accessible and accessible conductive parts shall not be hazardous live either under normal (absence of fault) conditions or under single-fault conditions. Protection under single-fault conditions is provided by fault protection (protection against indirect contact) mainly by automatic disconnection of supply with overcurrent devices and/or residual current devices. Residual current devices ensure automatic disconnection of supply especially if the impedance of the fault limits the current to a value that is below the overcurrent protection threshold. In special cases, e.g. for areas with a low-impedance contact of persons with earth potential additional protection is required. Then the use of residual current devices with a rated residual operating current not exceeding 30 mA ($I_{\Delta n} \leq 30 \text{ mA}$) is appropriate. Such residual current devices prevent serious injury in case of direct contact (Fig. 1).

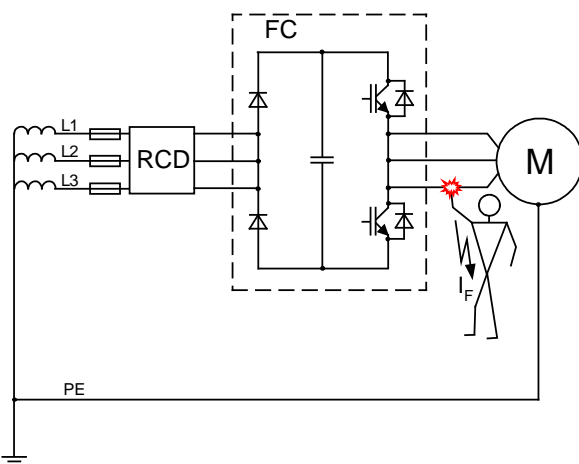

Fig. 1. Simplified diagram of circuit with variable speed drives. FC – frequency converter, RCD – residual current device, M – motor, I_F – touch current in case of direct contact

Proper operation of typical residual current devices and effectiveness of protection against electric shock is not guaranteed in circuits with variable speed drives. Earth fault or direct contact in the output terminals of inverter gives strongly distorted earth fault current. Distortion of the current depends on the present motor speed and PWM frequency. Fig. 2 presents waveform and spectrum of earth fault current (performed as a Tcad software simulation [2]) in a circuit with motor supplied via frequency converter.

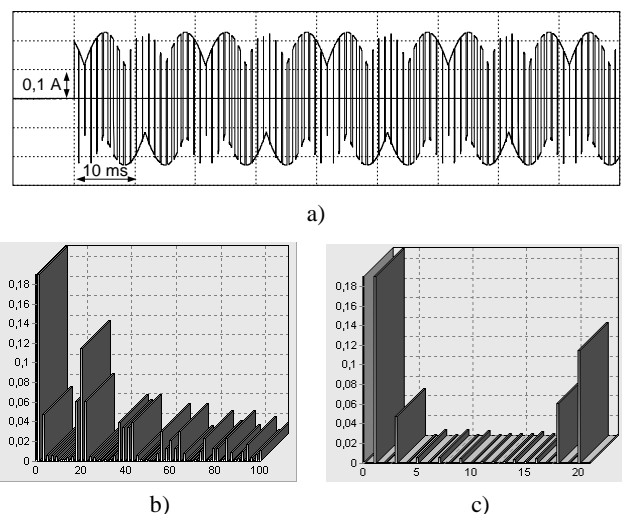

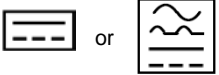

Fig. 2. Earth fault current (a) in case of fault in the output terminals of the frequency converter (TCad simulation) and its spectrum of harmonics (b, c). Motor frequency 50 Hz, PWM frequency 1 kHz

Residual current devices are performed according to the respective standards [3, 4]. The range of the standard tests is not wide (Tabl. 1). There are no testing current waveforms with harmonics, especially high-order harmonics as in circuits with variable speed drives. Very narrow range of tests are performed for AC type residual current devices but these type of devices are very often installed in circuits with distorted earth fault currents.

Table 1. Classification of the residual current devices according to the new international standards [3, 4]

Alphabetical symbol	Graphical symbol	Destination of residual current devices
AC		– for residual sinusoidal alternating currents (usually 50/60 Hz)
A		– as for type AC, – for residual pulsating direct currents, – for residual pulsating direct currents superimposed on a smooth direct current of 6 mA, with or without phase-angle control, independent of polarity, whether suddenly applied or slowly rising.
B		– as for type A, – for residual sinusoidal alternating currents up to 1000 Hz, – for residual smooth direct current of 0,4 times the rated residual current $I_{\Delta n}$ or 10 mA whichever is the highest value superimposed on an alternating current, – for residual smooth direct current of 0,4 times the rated residual current $I_{\Delta n}$ or 10 mA whichever is the highest value superimposed on a pulsating direct current, – for residual direct currents which may result from rectifying circuits, i.e.: - two-pulse bridge connection line to line for 2-, 3- or 4-pole devices, - three-pulse star connection or six-pulse bridge connection for 3- and 4-pole devices, – for residual smooth direct currents, with or without phase-angle control, independent of polarity, whether suddenly applied or slowly rising.

In electrical circuits with modern electric equipment containing power electronic components, the residual current devices tripping characteristics may be different from those obtained for standard test. High frequency or distorted earth fault current has negative effect on tripping of residual current devices [5-10]. Thus, protection against electric shock may be ineffective. The following paragraphs present distorted testing currents and tripping characteristics of residual current devices for these selected distorted current waveforms.

The scope of laboratory test

The laboratory test was performed using programmable power supply generating distorted earth current. In the first part of the test, current comprised the fundamental (50 Hz) and one harmonic was generated. The test was carried out for two selected harmonics: 3rd and 49th. The phase angle of the earth fault current harmonic varied with 45° step. Participation of the particular harmonics was the following: 0,10; 0,50; 1,00; 2,00; (in Fig. 3a, 3b and Fig. 4a, 4b it is marked 10%, 50%, 100%, 200%, respectively; “sin 50Hz” describes pure sinusoidal earth fault current).

The second part of the test was performed for currents comprising the fundamental and several harmonics – waveforms “w1”, “w2”, “w3”, “w4”. The types of waveforms containing several harmonics are described in Tabl. 2.

Tripping current of the residual current devices was also checked for the following earth fault currents: “w5”, “w6”, “w7” [6]. The current “w5” comprises harmonics which dominate in the earth fault current in case of fault in the output terminals of frequency converters for motor frequency equal to 50 Hz. This type of test current comprises the following frequencies:

- 50 Hz – motor frequency,
- 150 Hz – 3rd harmonic in respect to the motor frequency and voltage frequency of the rectifier neutral point,
- 1000 Hz – inverter PWM frequency,

- 900 and 1100 Hz – main interharmonics of PWM frequency.

Table 2. Content of harmonics in the testing waveform: w1, w2, w3, w4

Waveform “w1” comprises harmonics: $A_3 = 0,3 \quad \alpha_3 = 0^\circ$ $A_5 = 0,15 \quad \alpha_5 = 0^\circ$ $A_7 = 0,05 \quad \alpha_7 = 0^\circ$ $A_9 = 0,05 \quad \alpha_9 = 0^\circ$ $A_{11} = 0,02 \quad \alpha_{11} = 0^\circ$ $A_{49} = 0,3 \quad \alpha_{49} = 0^\circ$	Waveform “w2” comprises harmonics: $A_3 = 0,3 \quad \alpha_3 = 0^\circ$ $A_5 = 0,15 \quad \alpha_5 = 0^\circ$ $A_7 = 0,05 \quad \alpha_7 = 0^\circ$ $A_9 = 0,05 \quad \alpha_9 = 0^\circ$ $A_{11} = 0,02 \quad \alpha_{11} = 0^\circ$ $A_{49} = 1,0 \quad \alpha_{49} = 0^\circ$
Waveform “w3” comprises harmonics: $A_3 = 0,3 \quad \alpha_3 = 180^\circ$ $A_5 = 0,15 \quad \alpha_5 = 0^\circ$ $A_7 = 0,05 \quad \alpha_7 = 0^\circ$ $A_9 = 0,05 \quad \alpha_9 = 0^\circ$ $A_{11} = 0,02 \quad \alpha_{11} = 0^\circ$ $A_{49} = 0,3 \quad \alpha_{49} = 0^\circ$	Waveform “w4” comprises harmonics: $A_3 = 0,3 \quad \alpha_3 = 180^\circ$ $A_5 = 0,15 \quad \alpha_5 = 0^\circ$ $A_7 = 0,05 \quad \alpha_7 = 0^\circ$ $A_9 = 0,05 \quad \alpha_9 = 0^\circ$ $A_{11} = 0,02 \quad \alpha_{11} = 0^\circ$ $A_{49} = 1,0 \quad \alpha_{49} = 0^\circ$

The test current “w6” reflects the earth fault current in case of earth fault in the output terminals of frequency converters for motor frequency equal to 25 Hz. This current comprises the following frequencies:

- 50 Hz – motor frequency,
- 75 Hz – 3rd harmonic in respect to the motor frequency,
- 150 Hz – voltage frequency of the rectifier neutral point,
- 1000 Hz – inverter PWM frequency.

The test current “w7” reflects the earth fault current for motor frequency equal to 1 Hz. This current comprises the following frequencies:

- 150 Hz – voltage of the rectifier neutral point,
- 1000 Hz – inverter PWM frequency.

The frequency equal to 1 Hz is avoided since its participation with respect to the other components is negligible.

The laboratory test results

Tested were the residual current devices with rated operating residual current $I_{\Delta n}$ from 30 to 500 mA, type AC, type A and type B. Below (Fig. 3 and Fig. 4) are presented, as an example, only selected results for residual current devices numbered RCD6 and RCD15. Results of the test indicate that tripping current of residual current devices strictly depends on the residual current waveform.

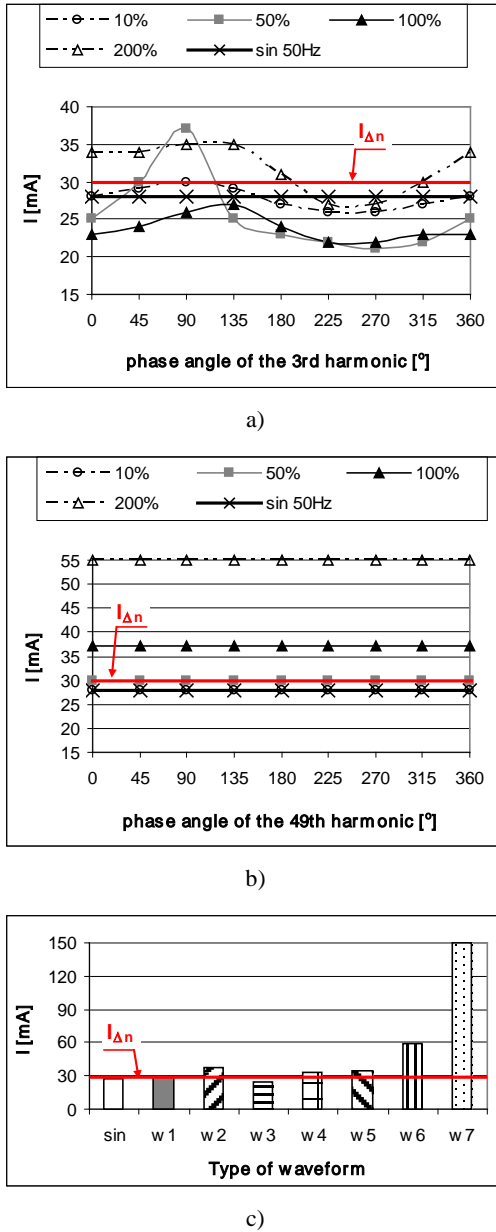

Fig. 3. Tripping current of the RCD6: $I_{\Delta n} = 30$ mA, type AC; residual current comprises: a) 1st and 3rd harmonics, b) 1st and 49th harmonics, c) several harmonics

Current containing high-order harmonic (Fig. 3b, Fig. 4b) makes the tripping current of residual current devices rise with comparison to the current containing relatively low-order harmonic (Fig. 3a, Fig. 4a). For the current waveform with high-order harmonics and its significant participation (100% and 200% in Fig. 3b, Fig. 4b) tripping current of residual current devices exceeds the $I_{\Delta n}$ current. Furthermore, for two

currents comprising the same level of harmonics but different phase angle, tripping current is also different (compare phase angle 0° and 90° for 50% in Fig. 3a).

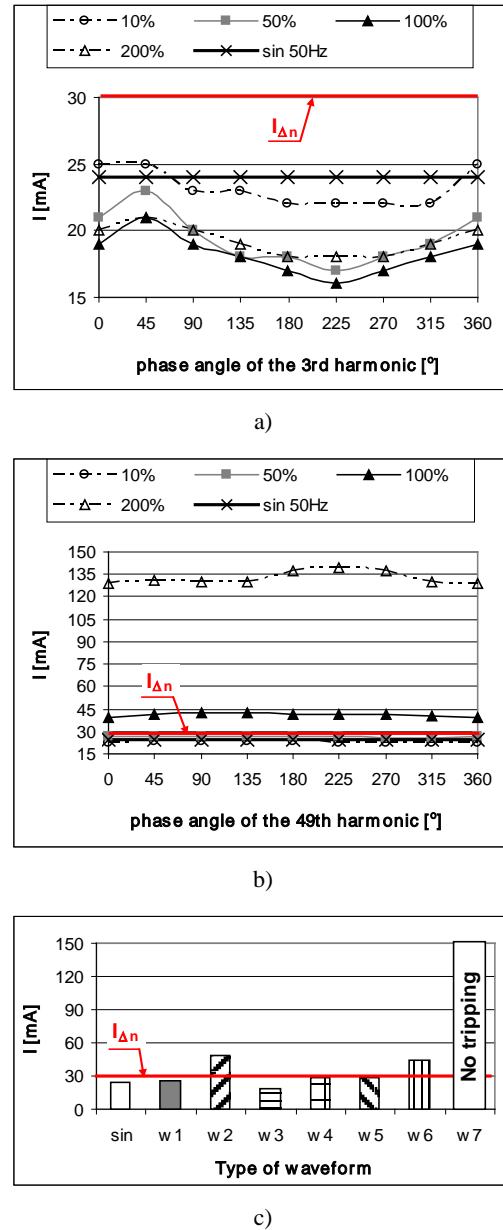

Fig. 4. Tripping current of the RCD15: $I_{\Delta n} = 30$ mA, type A; residual current comprises a) 1st and 3rd harmonics, b) 1st and 49th harmonics, c) several harmonics

Tripping current of residual current devices also varies for currents comprising several harmonics (Fig. 3c and Fig. 4c). The most dangerous are waveforms containing relatively high level of high-order harmonics as “w2”, “w6” and especially “w7”. The laboratory test has indicated that for such waveforms some residual current devices may not trip at all (for example RCD15 – see “w7” in Fig. 4c).

Conclusions

Spectrum of the earth fault current harmonics has fundamental significance for the residual current devices operational characteristics. Important is not only the

percentage content of a particular harmonic but also its phase angle. Tripping current rises if the earth fault current comprises high-order harmonics. Several tested residual current devices do not react to the residual current of waveform “w7”. This is dangerous in terms of protection against electric shock. For such waveform the new solutions of residual current devices [11] should be applied. It is necessary to make amendments to the international standards concerning residual current devices performance and testing in order to achieve proper protection with the use of residual current devices in circuits with strong distorted earth fault current.

References

1. **EN 61140:2002.** Protection against electric shock. Common aspects for installations and equipment.
2. **TCad 7.** Symulator układów energoelektronicznych i układów napędu przekształtnikowego. Copyright © Wydział Elektrotechniki i Automatyki Politechniki Gdańskiej w Gdańsku.
3. **IEC 62423:2007.** Type B residual current operated circuit-breakers with and without integral overcurrent protection for household and similar uses (Type B RCCBs and Type B RCBOs).
4. **IEC 60755:2008.** General requirements for residual current operated protective devices.
5. **Czapp S.** Protection against electric shock using residual current devices in circuits with electronic equipment // *Electronics and Electrical Engineering*. – Kaunas: Technologija, 2007. – No. 4 (76). – P. 51–54.
6. **Czapp S.** The impact of higher-order harmonics on tripping of residual current devices // *Proceedings of the 13th International Power Electronics and Motion Control Conference EPE-PEMC 2008, Poznań, Poland, 1–3 September 2008*. – P. 2082–2088.
7. **Grünebast G.** Allstromsensitive Fehlerstromschutzrichtungen // *Teil 2: Vorschriftsmässiger Einsatz. Elektropraktiker*, 2008. – No. 2. – P. 144–149.
8. **Kleemeier M.** Alle Arten von Fehlerströmen im Griff // *Der Elektro- und Gebäudetechniker*, 2006. – No. 15–16. – P. 104–106.
9. **Lee T. M., Chan T. W.** The effects of harmonics on the operational characteristics of residual current circuit breakers // *International Conference on Energy Management and Power Delivery. Proceedings of EMPD '95. 21–13 Nov., 1995*. – Vol. 2. – P. 715–719.
10. **Siedelhofer B., Muschong M.** Fehlerstrom-Schutzrichtungen bei besonderen Anwendungen (2). Auswahl und Einsatz // *Der Elektro- und Gebäudetechniker*, 2005. – No. 8. – P. 46–48.
11. **Czapp S.** Elimination of the negative effect of earth fault current higher frequency on tripping of residual current devices // *Electronics and Electrical Engineering*. – Kaunas: Technologija, 2009. – No. 3(91). – P. 85–88.

Received 2010 02 09

S. Czapp. Comparison of Residual Current Devices Tripping Characteristics for Selected Residual Current Waveforms // *Electronics and Electrical Engineering*. – Kaunas: Technologija, 2010. – No. 4(100). – P. 7–10.

According to the international standards circuits for electrical devices in the area of high risk of electrocution should be protected by high sensitivity residual current devices. In order to achieve effectiveness of protection against electric shock, residual current devices should be capable of detecting a waveform of residual current under the given conditions. Laboratory tests performed by the author indicate that tripping current of residual current devices is strictly dependent on the residual current waveform. In some cases the tripping current for a distorted residual current may be much higher than for a sinusoidal waveform. For residual current with high-order harmonics, as in circuits with variable speed drives, some residual current devices do not trip at all. In the paper a comparison of tripping current of residual current devices for various residual current waveforms is presented. The impact of the waveform of residual current on the effectiveness of protection against electric shock with the use of residual current devices is discussed. Ill. 4, bibl. 11, tabl. 2 (in English; abstracts in English, Russian and Lithuanian).

С. Цзапп. Исследование формы тока утечки с учетом релейных характеристик // *Электроника и электротехника*. – Каунас: Технологія, 2010. – № 4(100). – С. 7–10.

Анализируется влияние тока утечки релейных устройств согласно требованиям международных стандартов. Доказано, что форма тока утечки может быть выше, чем форма сигнала тока защиты. Представлены полученные формы сигналов тока. Найдены оптимальные формы сигнала тока для разных случаев. Ил. 4, библи. 11, табл. 2 (на английском языке; рефераты на английском, русском и литовском яз.).

S. Czapp. Srovės nuotėkio relės charakteristikų palyginimas su pasirinktomis nuotėkio srovės signalo formomis // *Elektronika ir elektrotechnika*. – Kaunas: Technologija, 2010. – Nr. 4(100). – P. 7–10.

Pagal tarptautinius standartus labai pavojingos elektros grandinės turi būti apsaugotos srovės nuotėkio relėmis. Nuotėkio srovės efektyvumui padidinti būtina nustatyti nuotėkio srovės signalo formą esant tam tikroms sąlygoms. Laboratoriniais bandymais nustatyta nuotėkio srovės signalo formos įtaka srovės nuotėkio relės apsaugančiajai srovei. Kai kuriais atvejais nuotėkio srovė, būdama netaisyklingos ir iškraipytos signalo formos, gali būti didesnė už sinusoidinio signalo formos apsaugančiąją srovę. Pateiktos ir aptartos nuotėkio srovės bei apsaugančiosios srovės signalo formos. Aptarta, kokios turi būti nuotėkio srovių signalo formos elektros grandinėse, siekiant didesnio efektyvumo. Il. 4, bibl. 11, lent. 2 (anglų kalba; santraukos anglų, rusų ir lietuvių k.).