

Flow and pool boiling on porous coated surfaces

The final publication is available at <https://www.degruyter.com/document/doi/10.1515/REVCE.2011.007/html>

Janusz T. Cieśliński

Division of Ecoengineering and Combustion Engines,
Gdansk University of Technology, Narutowicza 11/12,
80233 Gdansk, Poland, e-mail: jcieslin@pg.gda.pl

Abstract

Industrial demands for more efficient boilers and evaporators as well as economic incentives have encouraged the development of methods to increase boiling heat transfer coefficients, critical heat fluxes, and, where possible, to obtain the highest heat flux by applying the smallest wall superheat. The goal may be to reduce the heat exchanger size or pumping power required for a specified heat duty, and also to prevent excessive temperature, or even system destruction, in systems where heat generation rates are fixed – for instance, in nuclear fuel assemblies or in chemical reactors. Numerous enhanced surfaces have been developed to intensify flow as well as pool boiling heat transfer. Excellent reviews on that topic have been provided in textbooks. Porous coated surfaces, which this article deals with, belong to the efficient categories of enhanced boiling surfaces. This article reviews the selected results of a comprehensive study of flow and pool nucleate boiling on porous coated surfaces completed in our laboratory. Particularly, this article deals with the following: (1) nucleate pool boiling on flat circular plates and horizontal tubes covered with porous coatings. Particularly, the influence of coating thickness and porosity on heat transfer coefficient and burnout heat flux for distilled water at atmospheric pressure was studied; (2) nucleate pool boiling on horizontal tube partially coated with a porous metallic layer. The possibility of porous coating application to local heat transfer enhancement, for instance in order to smooth and alleviate circumferential temperature distribution during nucleate pool boiling on horizontal, electrically heated tube, was examined; (3) nucleate pool boiling from small horizontal tube bundles built of porous coated tubes. The effect of the tube pitch and operating pressure on local, i.e., for a single tube or selected row of tubes, and average, i.e., for the whole tube bundle, heat transfer coefficient for three working fluids (distilled water, methanol, and refrigerant R141b) was studied. The bundle factor and bundle effect were determined. Second, practical application of porous coated tube bundle as an evaporator in prototype two-phase thermosyphon heat exchanger was investigated; (4) flow boiling of pure refrigerants and refrigerant/oil mixture inside porous coated tubes. The average evaporation heat transfer coefficient and simultaneous pressure drop during evaporation of R22, R134a, and R407C and their oil mixture of different concentrations was studied. A correlation equation for heat transfer coefficient calculation during flow

boiling of pure refrigerants inside a tube with porous coating is proposed.

Keywords: flow boiling; pool boiling; porous coatings; two-phase thermosyphon heat exchanger.

1. Introduction

Nucleate boiling, as a very efficient mode of heat transfer, is employed in component cooling where the task of primary importance is to obtain the highest heat flux density by applying the smallest wall superheat (e.g., in cryogenic systems) in electronic equipment, in superconducting magnets, or in various energy conversion systems, such as nuclear reactor fuel assemblies, chemical reactors, or rocket nozzles, where large energy generation rate per volume is occurring. This has motivated numerous studies on boiling heat transfer. However, the boiling mechanism is so complicated that a pure analytic expression for the heat transfer, derived from basic relations, still remains a formidable task.

The boiling heat transfer can be intensified by increasing the number of active centres of vapour generation and also increasing the heat supply to vapour bubbles in the process of their growth. This can be obtained by creating different surface conditions, such as micro- and macroroughness, finning, vibrorolling, tunnel-and-pore forming, and porous coating (Bergles et al. 1979, Thome 1990, Webb 1994, 2004, Bergles 2002).

It is well known that covering of heater surface with a thin porous layer can considerably augment boiling heat transfer compared with a smooth surface. First, nucleate boiling commences at a lower wall superheat. Second, the whole boiling curve can be shifted left towards lower superheats, so at the same wall superheat (heat flux) the heat transfer coefficient can be an order of magnitude higher. Third, two to four times critical heat flux (CHF) increase is reported in the literature. The final enhancement depends on the parameters of the porous coating, i.e., thickness, porosity, mean porous diameter, size distribution of the pores as well as porous layer material, and last but not least fabrication method, because metallic contact between porous covering and base material is of primary importance (Thome 1990, Cieśliński 1996, Poniewski 2001).

The need for smaller and more cost-effective CPU chips and microprocessors ensures that new heat transfer surfaces are continuously being developed and tested. You and co-workers (Chang and You 1997) successively developed microporous coatings using various particles: alumina, silver flakes, diamond, copper, and aluminium. The particles sizes ranged from about 1 to 50 μm – at least an order of magnitude smaller than the feature

sizes of commercial enhanced surfaces (High-Flux, GEWA, Turbo-B). Their coated flat-heater surface immersed in saturated FC-72 showed about a 300% enhancement in nucleate boiling heat transfer coefficient and about a 100% increase in CHF over the non-coated surface. Ammerman and You (2001) performed experiments with FC-87 boiling inside a single 2 mm square cross-section channel of 8 cm in length. The painting technique was applied to produce porous coating of a thickness of ~ 100 μm . The particles were 8–12 μm industrial diamond powder. The application of the microporous coating resulted in boiling incipience at lower wall superheats, considerable heat transfer augmentation, and enhancement of CHF. Furthermore, application of the porous layer leads to minor impact on pressure drop in the case of subcooled flow boiling. Rainey et al. (2001) studied the effects of fluid velocity and subcooling on the heat transfer performance from a microporous, flat (10 \times 10 mm) surface mounted at the bottom of a square horizontal channel. The porous coating was fabricated by use of the painting technique and was ca. 50 μm thick. Microporous structure consisted of aluminium particles 1–20 μm in diameter and epoxy. The tests were conducted with FC-72 at atmospheric pressure. Rainey et al. determined that higher fluid velocities than for the smooth surface are required to provide additional enhancement of nucleate boiling heat transfer. In addition, the enhancement of CHF provided by the microporous coating over the smooth surface increases with increased fluid subcooling; however, compared with the smooth surface, the enhancement effectiveness of the coating decreases with increased velocity.

New advances within nano- and microtechnologies are giving this development of enhanced boiling surfaces new possibilities. Theofanous et al. (2002) showed that nanoscale imperfections and defects were sufficient to initiate heterogeneous boiling at low superheats, on nanoscopically smooth heater. Vemuri and Kim (2005) have reported that a structure with only nanosized pores was promoting lower superheats at boiling incipience. Recently, Vasiliev et al. (2010) proposed an advanced hybrid technology that incorporates elements from both passive and active loop technologies. A thin (0.3 mm) copper sintered powder (mean particle diameter 82 μm) structure with open-type micro- and macropores (porosity $\sim 50\%$) ensures the micro heat pipe phenomena in the wick and stimulates the evaporative heat transfer. The heat transfer coefficient in the minichannel with such porous coating is nearly 8–10 times higher than the pool boiling heat transfer on a smooth horizontal tube during propane boiling.

Forrest et al. (2010) showed that the application of nanoparticle coating to boiling surface significantly enhances both the CHF and heat transfer coefficient during boiling of deionized water on a nickel wire. The thickness of silica nanocoatings of different surface wettabilities ranged from 300 nm to 1 μm . The boiling heat transfer coefficient increases with reduced wettability. Nanocoatings treated with fluorosilane displayed hydrophobicity and were found to enhance the heat transfer coefficient by about 100%. CHF enhancement was observed for all nanocoatings tested. The enhancement ranged from 44% to 100% with the highest enhancement observed for the thickest, calcinated coating.

Kwark et al. (2010a) established that nanoparticle coatings generated by natural precipitation, natural convection, and applied electric field produced minimal nanoparticle deposition that have a negligible effect on CHF. Kwark et al. (2010b) studied experimental pool boiling of pure water on flat heaters covered with nanocoating produced during nanofluid pool boiling experiments (Al_2O_3 -water/acetone). The average thickness of nanocoatings was measured to be from ~ 1 to ~ 3 μm for the boiling times of 15 and 120 min, respectively. The nanocoatings developed can significantly enhance CHF.

Application of porous coating usually results in strong hysteresis phenomena. Hysteresis effect is generally considered a negative phenomenon as it causes instability of the cooling system (Bohdal 2006). Different types of boiling heat transfer hysteresis are much more clearly manifested on surfaces with porous coatings than on smooth surfaces; therefore, boiling curves display different shapes, depending on the combination of the porous coating parameters and thermophysical parameters of boiling liquid (Styrikovich et al. 1990, Malysenko 1997, Poniewski 2004, Wójcik 2010).

The published literature shows that the mechanism of boiling on porous coated surfaces is far from being completely understood. However, some progress has been made in theoretical modelling. There are several mechanisms that have been postulated for boiling from surfaces with porous coatings. Excellent critical reviews of the proposed models for boiling on porous coated surfaces have been carried out by Webb (1994), Cieśliński (1996), and most lately by Poniewski and Thome (2008).

This article reviews the selected results from our own experiments and those of others on the different aspects of a comprehensive study of nucleate flow and pool boiling on metallic porous coatings fabricated by thermal spraying. Particularly, the influence of coating thickness and porosity on heat transfer coefficient and burnout heat flux for distilled water at atmospheric pressure is discussed. Next, the possibility of porous coating application to local heat transfer enhancement, for instance in order to smooth and alleviate circumferential temperature distribution (CTD) during nucleate pool boiling on a horizontal, electrically heated tube, is presented. Results of heat transfer during boiling on a small porous tube bundle and from an evaporator made of porous coated tube are discussed as well. Finally, results for flow boiling of pure refrigerants and refrigerant/oil mixture inside a porous coated tube are discussed.

2. Nucleate pool boiling on flat circular plates and horizontal tubes

The flat test section was made from an electrolytic copper M1EZ4 cylinder 39.0 mm in diameter. Boiling occurred on the flat end surface of the cylinder, onto which the porous coating was deposited. The heat flux was determined by the gradient method. The details of the experimental set-up and test section are presented in Cieśliński (1991, 2002). Four methods of deposition were employed to form the metal coatings on the flat horizontal surfaces: dispersive electrolytic

treatment, plasma spraying, gas-flame spraying, and modified gas-flame spraying. The test sections were coated with aluminium, copper, molybdenum, and stainless-steel 1H18N9T, respectively. The coating thickness ranged from 0.15 to 2.0 mm, porosity from 10% to 65%, and mean pore radius from 1.5 to 8.93 μm . The pore size distribution was determined by metallographic scanning. On all of the specimens coated with aluminium, independent of the method of fabrication, an increase in the heat transfer rate as compared with that for a smooth surface was observed. As an example, Figure 1 illustrates the dependence of heat transfer coefficient against the thickness of high-porosity (above 50%) coatings, deposited onto the flat surface, for three values of heat flux density. For heat flux density of about 200 kW/m^2 , a strong influence of coating thickness is observed, with decrease of heat transfer coefficient with increase of the coating thickness. For lower heat flux density, the effect of coating thickness on heat transfer coefficient is much weaker, but simultaneously the heat transfer coefficient is distinctly lower than for higher heat flux density.

Experiments of nucleate pool boiling from porous coated surfaces were conducted using stainless-steel tubes with an outside diameter (OD) of 7.88, 11.18, 13.52, 18.02, and 23.57 mm, and an active length of ~ 250 mm. Coatings deposited onto the outer surface of tubes were fabricated by gas-flame spraying and modified gas-flame spraying. Different materials (Al, Cu, Mo, Zn, brass, acid-resistant and stainless-steel, and as inclusions Al, Cu, and Ag in dispersive electrolytic treatment) were employed to form coatings of 0.08–2.00 mm thickness, porosity of 10–65%, and mean pore radius of 1.11–10.5 μm . The pore size distribution was determined by metallographic scanning. Details about experimental rig and procedure are given in Cieřliński (1995). Figure 2 shows boiling curves obtained in saturated water for the test tubes (OD=13.52 mm) coated with Zn, Al, and Cu. For all porous

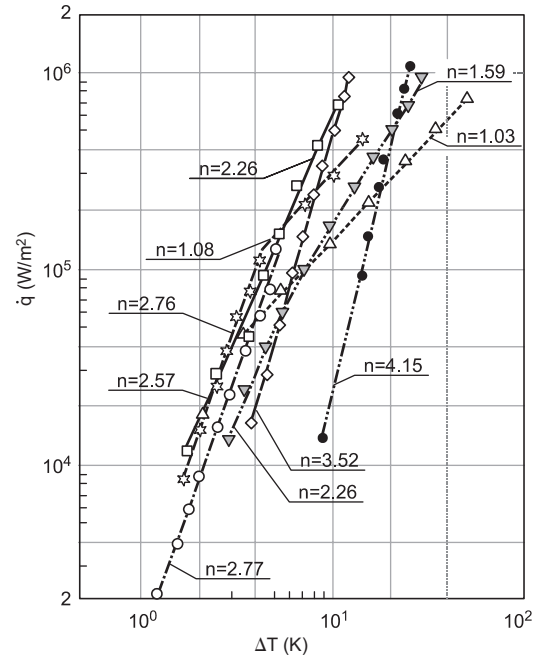

Figure 2 Boiling curves: ∇ (Zn, $\delta=0.18$ mm), \diamond (Al, $\delta=0.18$ mm), Δ (Al, $\delta=0.17$ mm), \square (Al, $\delta=0.15$ mm), \star (Al, $\delta=0.18$ mm), \circ (Cu, $\delta=0.23$ mm), \bullet smooth tube.

coated tubes, boiling commenced at lower wall superheats as compared with that for smooth surface. For instance, stable boiling on a tube covered with copper coating of 0.23 mm thickness and $\sim 40\%$ porosity took place at about 1.2 K wall superheat, while for smooth tube, at ~ 8 K. The application of a porous coating may result in the reinforcement of the so-called in-coating crisis. Probably due to the formation of the continuous vapour layer inside the matrix, the boiling curve changes its slope (Figure 3). Reasonable repeatability has been observed for the two runs conducted.

The presence of a porous coating on the surface results in some peculiarities in the burnout behaviour and progress. Boiling heat transfer enhancement by porous coating is well known, but its influence on boiling burnout is still problematic. For three rough tubes and six tubes with porous coatings investigated, the burnout points were reached (Figure 4). The recorded burnout heat fluxes ranged from 1.03 to 1.53 MW/m^2 . The solid lines determine the range of \dot{q}_{cr1} predicted by the Kutateladze-Zuber correlation (Cieřliński 2005), and the dashed lines the range of \dot{q}_{cr1} evaluated from the multistep model (Haramura and Katto 1983). The unique correlation recommended in the literature for predicting CHF on porous tubes is that by Polezajev and Kovalev (1990):

$$\dot{q}_{cr1} \approx 0.52 h_v \varepsilon^{2.28} \left[\frac{\sigma \rho_l \rho_v}{(\rho_l + \rho_v) \bar{a}} \right]^{0.5}$$

Unfortunately, this correlation well predicts the CHF for coatings of low porosity ($\varepsilon < 0.20$) and fails in the case of high-porosity coatings (the values of CHF are overestimated by as much as an order of magnitude).

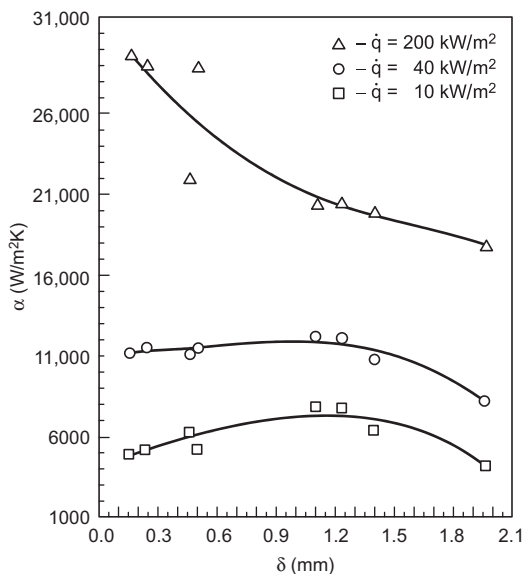

Figure 1 Effect of aluminium coating thickness on heat transfer coefficient ($\varepsilon > 0.50$).

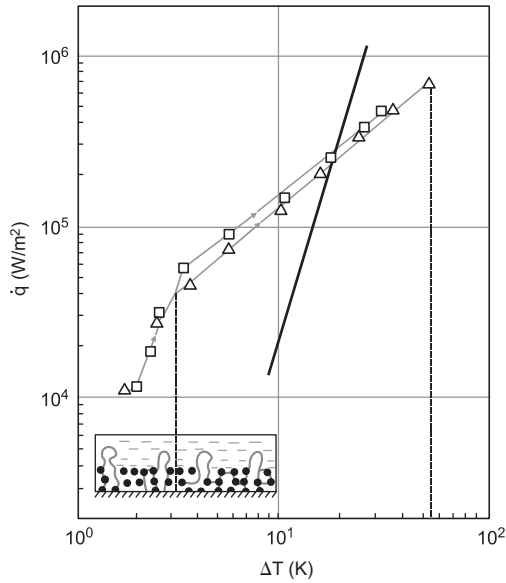

Figure 3 In-coating crisis for porous tubes (Al , $\delta=0.17$ mm, $\epsilon=24\%$, $\bar{a}=2.35\mu\text{m}$); solid line – smooth tube ($OD=13.52$ mm, $R_z\leq 0.4\mu\text{m}$); \square , first run; Δ , second run.

For two porous coated tubes, a drop in the wall superheat just before burnout was observed (Figure 5). This phenomenon, which may be called inverted boiling crisis, can be explained by liquid suction into the porous coating during

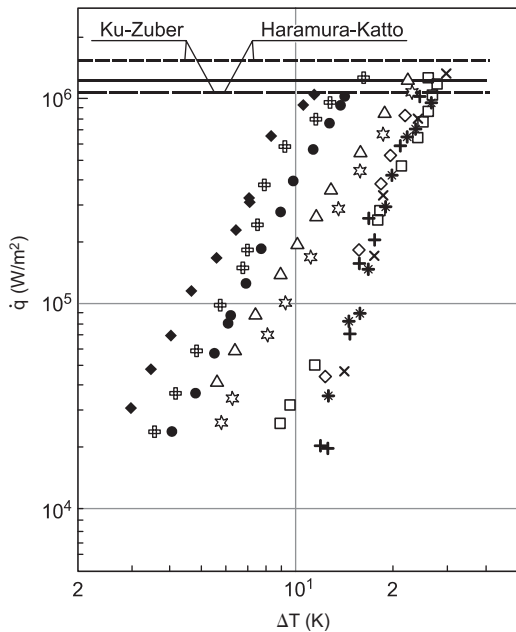

Figure 4 Burnout heat fluxes. \bullet – smooth ($R_z > 0.3\mu\text{m}$, $OD=7.88$ mm), \times – rough ($4 < R_z < 8\mu\text{m}$, $OD=7.86$ mm), $+$ – rough ($R_z < 8\mu\text{m}$, $OD=11.1$ mm), \diamond – sandblasted ($R_z < 4\mu\text{m}$, $OD=7.88$ mm), Δ – porous (Al , $\delta=0.08$ mm, $\epsilon=0.42$, $OD=7.88$ mm), \circ – porous (Al , $\delta=0.19$ mm, $\epsilon=0.12$, $OD=8.14$ mm), \blacklozenge – porous (Ms , $\delta=0.16$ mm, $\epsilon=0.13$, $OD=8.15$ mm), \oplus – porous (Ms , $\delta=0.18$ mm, $\epsilon=0.24$, $OD=8.14$ mm), \square – porous (Al , $\delta=0.20$ mm, $\epsilon=0.29$, $OD=8.15$ mm), \star – porous (Al , $\delta=0.20$ mm, $\epsilon=0.40$, $OD=8.15$ mm).

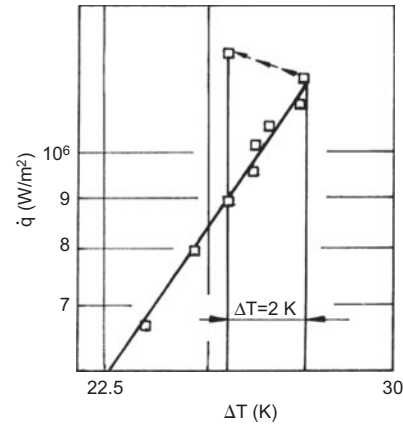

Figure 5 Inverted boiling crisis; porous coating: Al , $\delta=0.20$ mm, $\epsilon=0.92$, $OD=7.88$ mm.

the contact period of the bulk liquid with porous coating. The liquid absorbed extends the period of macrolayer evaporation and therefore delays the boiling crisis.

3. Nucleate pool boiling on horizontal tube partially coated with a porous metallic layer

During nucleate boiling on electrically heated horizontal tube, the CTD is observed (Fedders 1971, Gorenflo et al. 1990, Kang 2005). The literature review shows that there is no CTD systematic investigation during pool boiling on horizontal tubes, with different tube diameters, surface finishing, and thermophysical fluid properties. There is also no complete explanation of the CTD nature. Dominiczak and Cieśliński (2008) postulated that CTD outside a horizontal tube is caused by different heat transfer mechanisms occurring during nucleate pool boiling at a low heat flux condition. Thus, if CTD really results from different heat transfer mechanisms existing outside the horizontal tube, in order to avoid temperature difference heat transfer should be locally enhanced. Usually heat transfer enhancement techniques are applied to the whole heating surface and the entire heat flux density range, but application of turbulent inserts, with shape memory as a local heat transfer enhancement, shows expediency of such solution when the insert is activated above the “programmed” temperature. As mentioned above, the heat transfer coefficient can be many times higher than for a smooth surface when porous metallic coating is used. Therefore, Dominiczak and Cieśliński (2008) applied porous metallic coating as a local enhancement technique to smooth the CTD of the electrically heated horizontal tube during nucleate pool boiling. The test specimens were heated by using the tubes themselves as resistance heaters. Experiments of nucleate pool boiling have been conducted using stainless-steel tubes with ODs of 8.15, 13.52, 18.04, and 23.60 mm with an active length of 250 mm. The temperature of the inside surface of the test tube was measured in two manners: using a single thermocouple that displays

an average temperature of the inside surface t_{ax} , or applying an especially designed probe that allows measurement of the CTD. The hot junction of the single thermocouple was placed on the centre line of the tube at the midpoint of the test section. The probe consists of 6 or 12 thermocouples, which were cemented to the Teflon rod, and there was no contact between thermocouple hot junction and tube surface. The outside surface temperature, t_o , used for wall superheat determination was obtained as an analytical solution of the one-dimensional, steady-state heat conduction equation with uniform heat generation in the tube wall

$$t_o = t_{ax} + \frac{UID_o}{4\lambda A} \left[\frac{2 \ln(D_o/D_{in})}{(D_o^2/D_{in}^2) - 1} \right]$$

The details of the experimental set-up and experimental procedure are given in Dominiczak and Cieśliński (2008).

Experiments of nucleate pool boiling were conducted within low heat flux density ($q < 0.1q_{cr1}$) with two fluids: distilled water and HFC-141b. The investigation was divided into two stages. The first one was devoted to tubes with heating surface condition $R_a \leq 0.25 \mu\text{m}$, called smooth. The smooth tubes, when the first stage was completed, have been partially coated by a porous layer made of aluminium. The porous layer area fraction has been determined according to measured CTDs and direct observations during experiments with smooth tubes. Thus, the porous layer area, indicated by angle $\beta = 120^\circ$ (Figure 6) (Cieśliński and Dominiczak 2008), has been assumed.

As an example, CTD measured on the internal wall surface during pool boiling on a smooth tube is presented in Figure 7. Trigonometric polynomials were used for approximation of the temperature distribution (solid line in Figure 7). Temperature t_{ax} measured by axially placed single thermocouple is represented by dashed line, and solid line corresponds to average temperature $t_{av,s}$ calculated as the arithmetic mean from 6 or 12 thermocouple readings. The maximum and minimum temperatures appear near the upper and lower generatrix, respectively.

In the case of boiling R141b on modified tubes, three parts of the boiling curve were distinguished (Figure 8). Within line A-B, the single phase convection on the whole heating surface was observed. The first vapour bubbles appear only on the porous layer for $\Delta t = 12 \text{ K}$ (point B), and a single phase convection on the smooth part of the heating

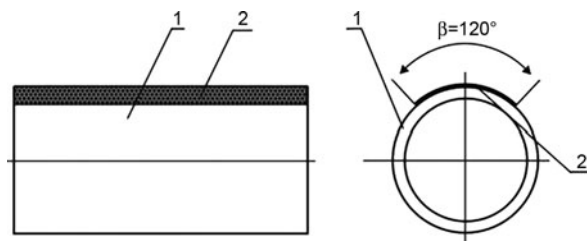

Figure 6 Porous layer location: 1 – tube, 2 – porous layer.

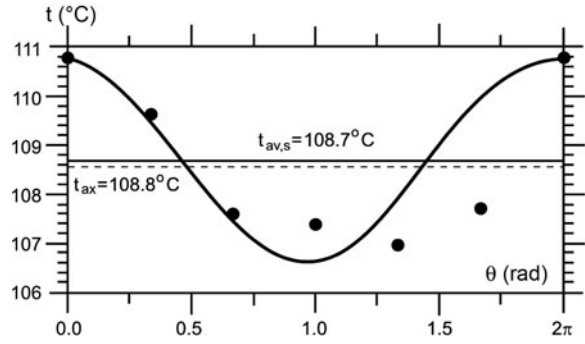

Figure 7 Circumferential temperature distribution on internal wall surface for water at $q = 14.1 \text{ kW/m}^2$ and smooth tube of OD = 13.52 mm.

surface was observed. The temperature drop B-C is related to heat transfer mechanisms replacement from single phase convection to nucleate boiling on porous layer. Part C-D of the boiling curve is associated with stable boiling process within the upper generatrix on the porous layer. The first vapour bubbles along the lower generatrix appear for $\Delta t = 15 \text{ K}$ (point D), and it causes another temperature drop, D-G. The line G-F-E corresponds to stable boiling on the whole heating surface area.

Figure 9 illustrates an example of CTD measured on a modified tube internal wall surface during pool boiling experiments with water. The porous layer provides favourable nucleation conditions, so the lowest temperature in the circumference was recorded within the upper generatrix. The maximum temperature was observed near the lower generatrix. In the case of boiling water, porous layer application has two effects. The first one is smoothing and alleviating of CTD, and the second one is a distinct lowering of average temperature $t_{av,m}$.

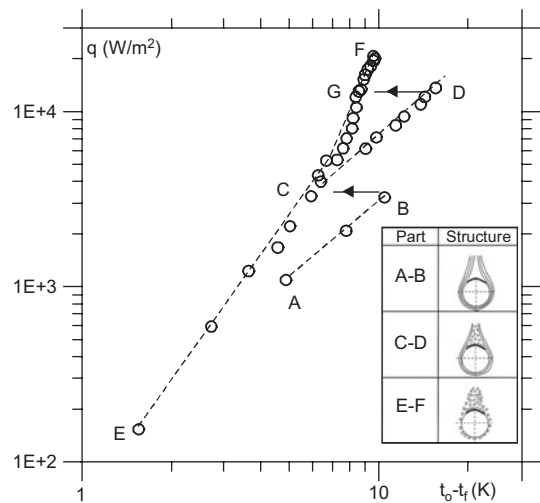

Figure 8 Boiling curve for R141b on a modified tube with OD = 13.52 mm.

MOST WIEDZY Downloaded from mostwiedzy.pl

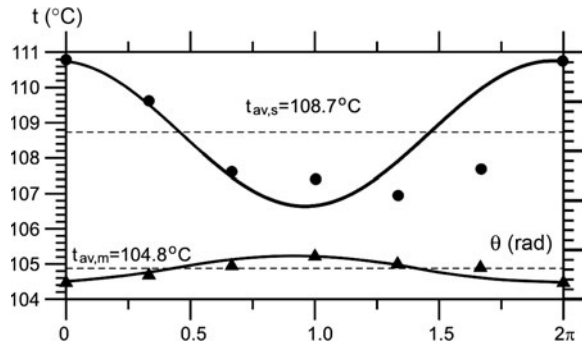

Figure 9 Circumferential temperature distribution on the internal wall surface for water boiling at $q \approx 14 \text{ kW/m}^2$ and tube of OD=13.52 mm: ●, smooth; ▲, modified.

4. Nucleate pool boiling from small horizontal porous coated tube bundles

Numerous studies were performed to understand bundle boiling heat transfer with smooth tubes. In particular, the effect of tube position within a bundle, operating conditions, bundle layout, and tube spacing were examined. Several correlations for the prediction of heat transfer coefficient of individual tubes as well as tube bundles were proposed (Collier and Thome 1999). The conventional approach is to use a superposition model for calculating the average boiling heat transfer coefficient for a tube bundle. For instance, Palen (1986) recommends the following formula, which algebraically sums the contributions of boiling and convection:

$$\bar{\alpha}_b = \alpha_{nb} F_b + \alpha_{nc}$$

where α_{nb} – nucleate pool boiling heat transfer coefficient for a single tube, α_{nc} – single phase free convection heat transfer coefficient for a tube bundle, F_b – bundle factor defined as a ratio of average heat transfer coefficient for the whole bundle to that of a single tube with the same surface (Figure 10).

A very important factor that has influence on bundle boiling heat transfer is a gap between the outer tube of a bundle and the vessel wall (shell). Two solutions can be differentiated in industrial practice:

- small tube bundle, where the tube bundle occupies only a small part of a cross section of the vessel (Figure 11A), and
- large tube bundle, where the tube bundle fulfils almost the entire cross section of the vessel (Figure 11B).

According to Gupta et al. (1995), for a small gap between the outer tube of the bundle and the vessel wall and under

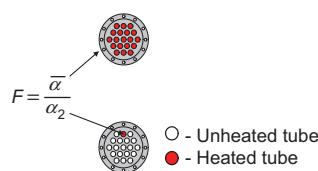

Figure 10 Illustration for the definition of the bundle factor.

cross-flow velocity conditions, the uniform distribution of vapour bubbles over the entire cross section of the channel can be assumed, and as a result the heat transfer relations can be expressed in terms of the void fraction or the Martinelli parameter. This approach is not suitable for small tube bundles placed in a large channel because in such a system, an accurate estimation of the local void fraction is not possible. Under low cross-flow velocity conditions (kettle reboilers, flooded evaporators), a gap between the outer tube of the bundle and the vessel wall strongly influences internal recirculation of liquid (Figure 12), and therefore affects heat transfer performance of the heat exchanger.

Data presented in the open literature regarding pool boiling on porous coated tube bundles are very scarce and fragmentary (Krasowski and Cieśliński 2011). Independent of the tested liquid (water, methanol, refrigerant R141b), pitch-to-diameter ratio (1.7 and 2.0), and operating pressure (15–100 kPa), higher heat transfer coefficients were obtained for porous coated tube bundles than for smooth tube bundles. As an example, Figure 13 shows boiling curves for R141b while boiling on smooth and porous coated tube bundles with a pitch-to-diameter ratio of 1.7 at atmospheric pressure. Additionally, the authors established that bundle factor decreases for porous coated tubes up to the heat flux density of ca. 25 kW/m^2 . For higher heat flux density, i.e., fully developed boiling regimen, the bundle factor is almost constant and reaches a value of ca. 0.95.

The results obtained by Krasowski and Cieśliński (2011) served as a database for a continuously developed two-phase thermosyphon heat exchanger (Fiuk and Cieśliński 2008). A prototype two-phase thermosyphon is a shell-and-tube, horizontal heat exchanger made of stainless-steel 1.4404 as a welded construction. The shell consists of two cylindrical vessels of 159 mm diameter and 1 m length connected by two risers and a downcomer (Figure 14). An evaporator is designed as a tube bundle consisting of 19 smooth, corrugated, or porous coated tubes (OD=10 mm) with a triangular arrangement and a pitch equal to 1.7d or 2.0d. Aluminium porous coatings were fabricated by plasma spraying. The average porosity of the coatings was 41%, the thickness ca. 0.15 mm, and the mean pore radius $2.77 \mu\text{m}$. The condenser is designed as a tube bundle consisting of 31 smooth stainless-steel tubes (OD=10 mm) with a triangular arrangement and a pitch equal to 1.8d. As working fluids, distilled water, methanol, and refrigerant R-141b were utilized. Experimental investigations were carried out making use of a six-prototype TPThEx (Cieśliński and Fiuk 2006).

Figure 15 illustrates the flow of liquid and vapour in prototype TPThEx against evaporator heat flux, and as an example, Figure 16 displays the influence of the type of tube surface on the TPThEx evaporator performance during boiling of the refrigerant R141b on tube bundle with a pitch of 1.7d.

Encouraging results obtained with our own design of the two-phase thermosyphon heat exchanger suggests that application of enhanced boiling and/or condensation surfaces in other types of two-phase thermosyphon heat exchanger (Figure 17) is desirable.

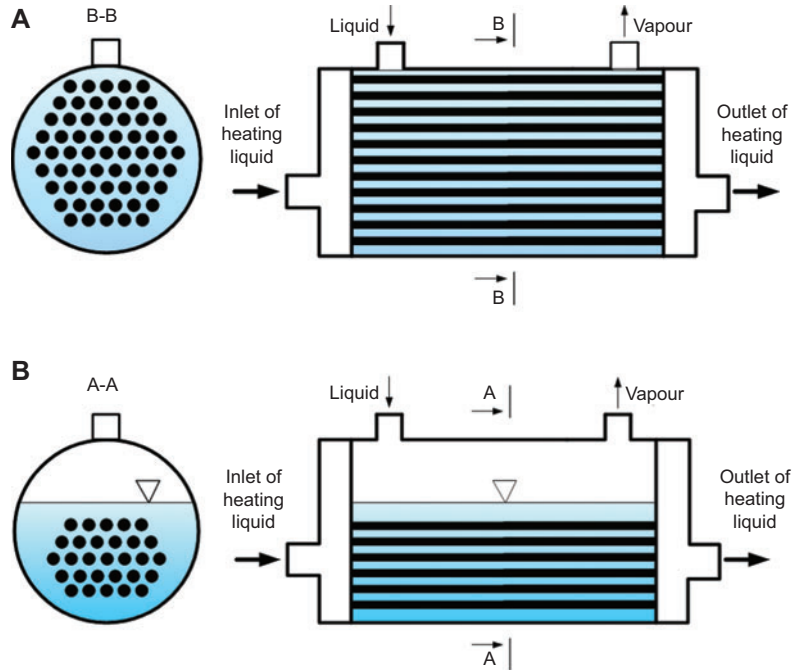

Figure 11 Large (A) and small (B) tube bundles.

5. Flow boiling inside tube with porous coating

Results from the open literature show that the application of a porous coating generally improves flow boiling performance. The increase in pressure drop as well as penalty-free heat transfer enhancement have been reported for porous coated channels. In addition, a porous layer modifies the dynamics of CHF. One of the first studies on flow boiling heat transfer inside a tube with porous coating was conducted by Czikk et al. (1981) using liquid oxygen, ammonia, and R22 inside a vertically oriented 18.7-mm-diameter tube internally covered with the commercially available high flux coating. They reported that the heat transfer coefficient for the porous-coated tube was insensitive to quality and mass flux and was typically an order of magnitude greater than that for smooth-tube

data. Malyshenko (1999) discussed three expected porous coating effects at stratified and intermittent two-phase flows in horizontal steam-generating channels, which can lead to the decrease of the wall temperature non-uniformity. Only a few articles report on flow boiling of refrigerants inside porous coated channels (Czikk et al. 1981, Ikeuchi et al. 1984, Kirin et al. 1984, Wadekar 1996). No data of flow boiling of oil/refrigerant mixture inside porous coated tubes have been found in the literature, although refrigeration seems to be a relevant area of application of porous coated channels.

Experimental study of pure R22, R134a, R407C, and their mixtures with polyester oil FUCHS Reniso/Triton SEZ 32 in a tube with porous coating has been conducted. The mass

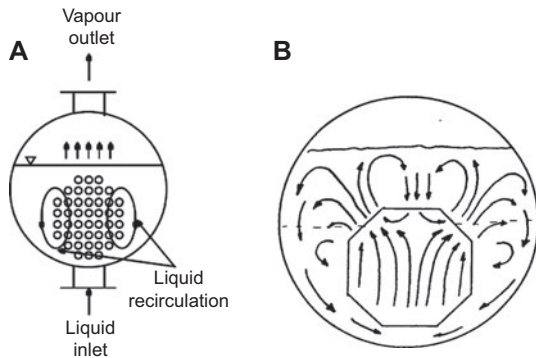

Figure 12 Fluid circulation in a kettle reboiler; (A) Pezo et al. (2006), (B) Shire et al. (1994).

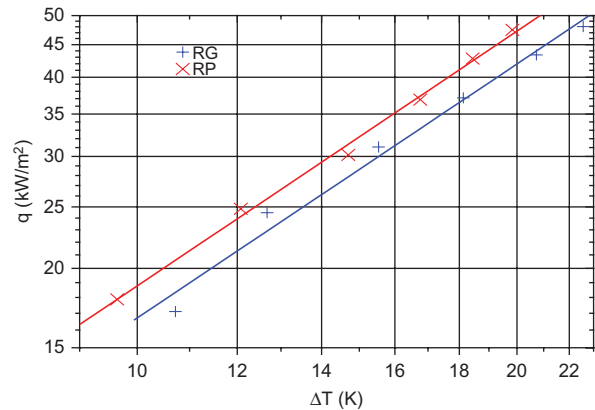

Figure 13 Boiling curves of methanol on smooth and porous coated tube bundles of pitch-to-diameter ratio 1.7 at atmospheric pressure; RG, smooth tube bundle; RP, porous coated tube bundle.

MOST WIEDZY Downloaded from mostwiedzy.pl

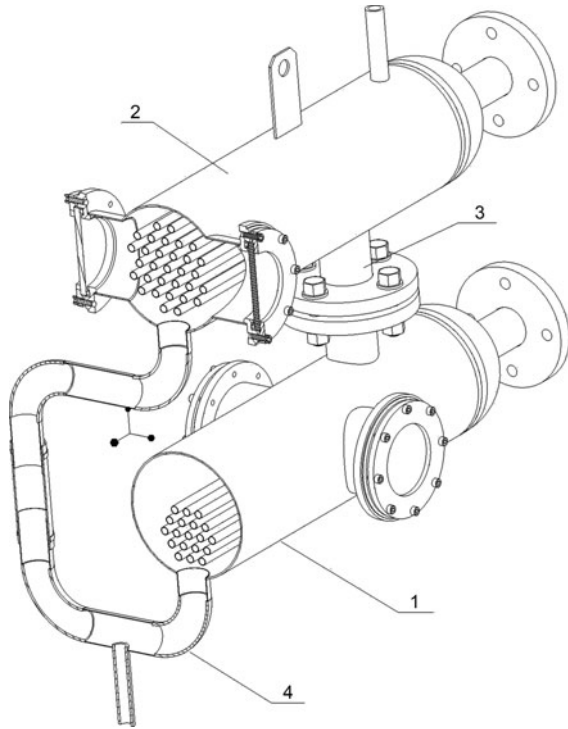

Figure 14 Axonometric view of the prototype TPThEx; 1, evaporator; 2, condenser; 3, riser; 4, downcomer.

fraction of oil was equal to 1% or 5%. During the tests, inlet vapour quality was set at 0 and outlet quality at 0.7. Mass velocity varied from about 250 to 500 kg/m² s. The experiments were conducted at an average saturation temperature of 0°C.

The test section consists of a tube-in-tube heat exchanger, sight glasses, and sensors for temperature and pressure measurement on the inlet and outlet of the section (Cieśliński and Dawidowicz 2007). The inner tube, i.e., the test tube, is a 2-m-long horizontal tube with an outer diameter of about

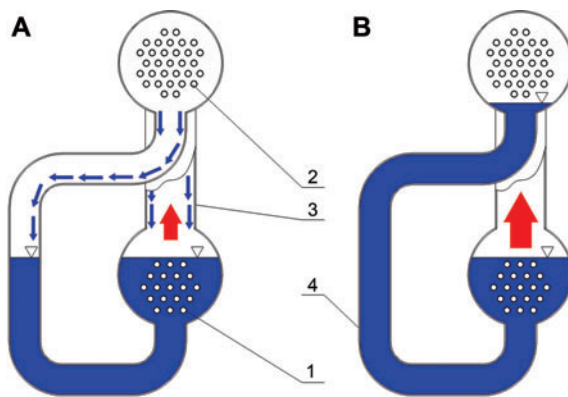

Figure 15 Liquid and vapour flow in TPThEx; 1, evaporator; 2, condenser; 3, riser; 4, downcomer. (A) $\dot{q} < 15 \text{ kW/m}^2$, (B) $\dot{q} > 15 \text{ kW/m}^2$.

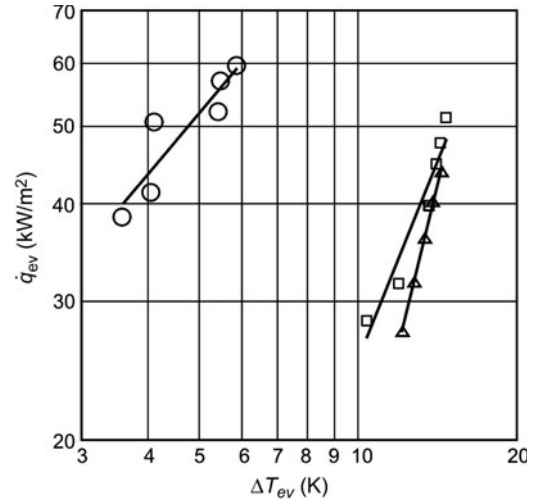

Figure 16 Boiling curves of R141b on tube bundles: O, porous coated tubes; □, corrugated tubes; Δ, smooth tubes.

10 mm. The inside wall tube was covered with metallic porous coating. The main parameters of the porous coating are as follows: thickness 55 μm, porosity 18%, and mean pore radius 1.45 μm. A smooth stainless-steel tube served as a reference tube. The water in the annulus gap, surrounding the test tube, flows counter to the refrigerant flow and is used to heat the refrigerant, evaporating in the inner tube.

Figure 18 shows a comparison of the present results for flow boiling of pure R22 inside a tube with porous coating with published data. Taking into account all differences in test tube design, i.e., diameter of the test tube, parameters, and method of fabrication of the porous coating, as well as different test conditions (vapour quality, mass velocity), the present data are in reasonable agreement with experimental results obtained by Czikk et al. (1981) and Ikeuchi et al. (1984).

As an example, Figures 19 and 20 show present results for flow boiling of pure R134a in a smooth stainless-steel tube and in a tube with porous coating. A linear regression analysis using the least squares method was applied to determine the best-fitting straight line. Like in pool boiling, the

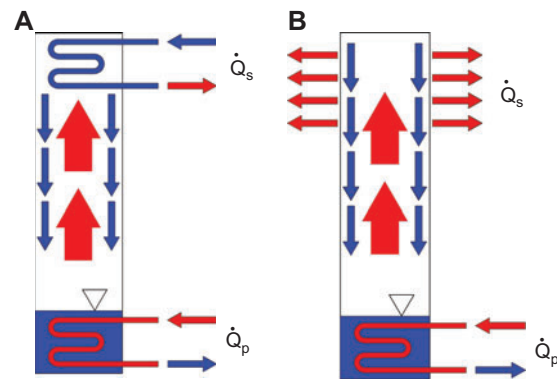

Figure 17 Two-phase thermosyphon. (A) Immersion thermosyphon; (B) immersion-indirect-thermosyphon.

MOST WIEDZY Downloaded from mostwiedzy.pl

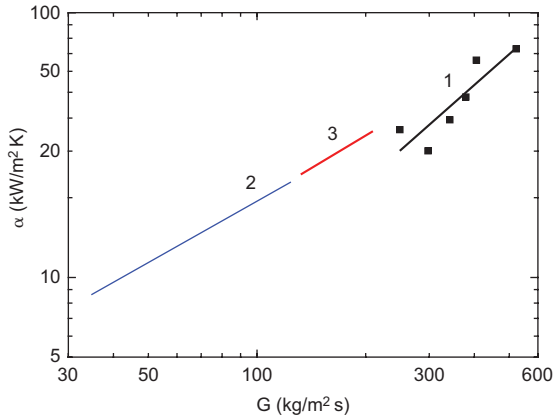

Figure 18 Heat transfer coefficient for flow boiling of R22 in a tube with porous coating: 1, present study; 2, Ikeuchi et al. (1984); 3, Czikk et al. (1981).

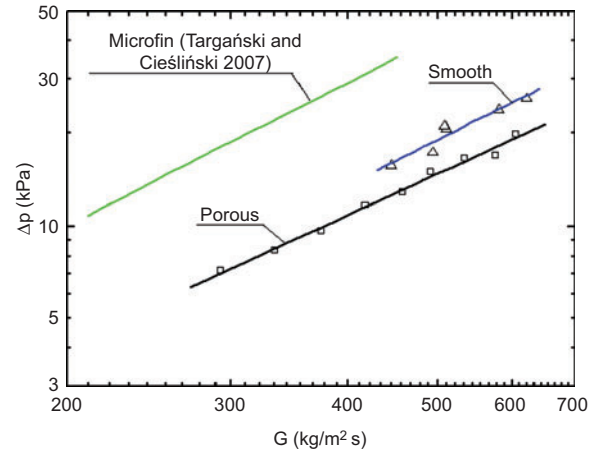

Figure 20 Pressure drop for flow boiling of pure R22 inside a smooth tube and a tube with porous coating.

application of a porous layer results in dramatic increase in heat transfer coefficient (Figure 19). For all three tested pure refrigerants, average heat transfer coefficient was five to six times higher than for a smooth tube for the same mass velocity. Simultaneously, lower pressure drop as compared with smooth tube for the same mass velocity and inlet/outlet vapour quality was recorded for the tube with porous coating (Figure 20). That phenomenon can be explained by strong aeration of a thermal layer by vapour bubbles generated inside porous coating, and as a result the liquid core is separated from the rough surface of a porous layer.

Figure 21 illustrates the influence of oil concentration on average heat transfer coefficient for flow boiling of R407C/oil mixture in a porous coated tube. Addition of even a small amount of oil results in an evident heat transfer degradation in comparison with boiling of pure refrigerant. For a lean mixture (1% of oil concentration), the average heat transfer coefficient is two times lower than for boiling of pure R407C. For a rich mixture (5% of oil concentration), heat transfer

coefficient decreases within the whole range of mass velocity investigated and similarly as for smooth stainless-steel tube, for mass velocity above 400 kg/m² s, a kind of boiling crisis has been observed and with mass velocity increase heat transfer hysteresis has been recorded.

Figure 22 shows the average heat transfer coefficient for pure R22, R134a, and R40C against mass velocity. Pure refrigerant R22 has an evident superiority over R134a and R407C while boiling inside a tube with porous coating.

To generalise the present data for flow boiling of pure refrigerants inside a tube with porous coating, a correlation equation originally developed by Mikielewicz et al. (2007) has been proposed. Particularly, a new correlation for pool boiling heat transfer coefficient on porous coated surfaces has been introduced:

$$\alpha_{PB}^* = C \cdot \dot{q}^n \tag{1}$$

where constant C and exponent n are given in Table 1.

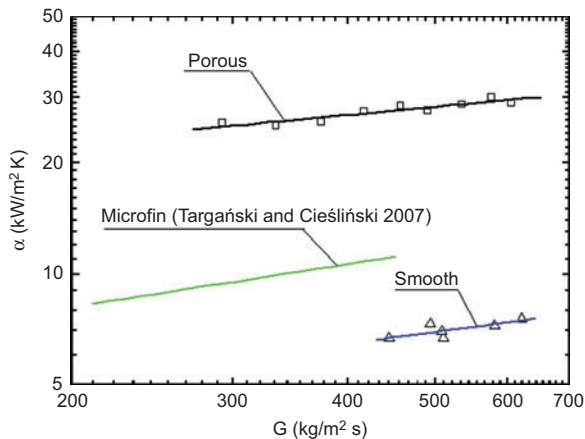

Figure 19 Average heat transfer coefficient for flow boiling of pure R134a inside a smooth tube and a tube with porous coating.

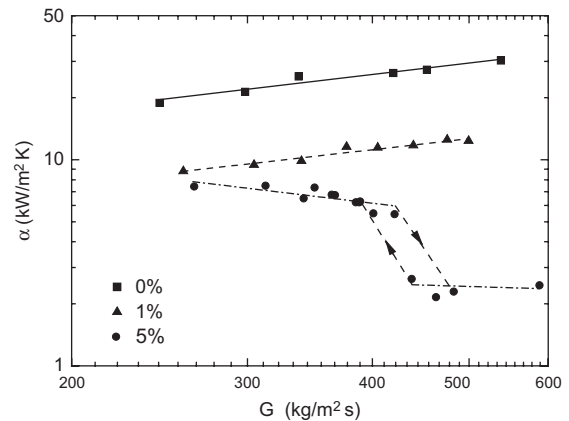

Figure 21 Influence of oil concentration on average heat transfer coefficient for flow boiling of R407C/oil mixture in a tube with porous coating.

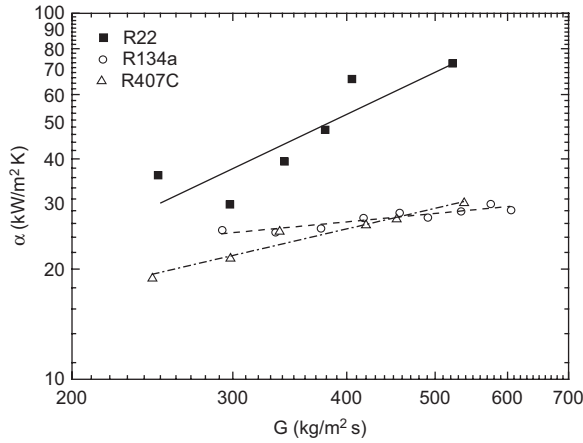

Figure 22 Average heat transfer coefficient for flow boiling of pure refrigerants R22, R134a, and R407C in a tube with porous coating.

Moreover, the exponents in the originally proposed correction factor P^* have been adjusted using the present experimental data. A modified version of P^* reads

$$P^* = 2.53 \cdot 10^{-3} (R_{M-S} - 1)^1 \text{Re}^{1.17} \text{Bo}^{0.65} \quad (2)$$

Finally, the proposed form of a correlation for heat transfer coefficient in flow boiling of pure refrigerants inside tubes with porous coating reads

$$\frac{\alpha_{TPB}}{\alpha_{REF}} = \sqrt{R_{M-S}^{0.76} + \frac{1}{1+P^*} \left(\frac{\alpha_{PB}^*}{\alpha_{REF}} \right)^2} \quad (3)$$

where R_{M-S} is a Muller-Steinhagen-Heck two-phase flow multiplier

$$R_{M-S} = \left[1 + 2 \left(\frac{1}{f_1} - 1 \right) x \right] \cdot (1-x)^{1/3} + x^3 \frac{1}{f_{1z}} \quad (4)$$

where functions f_1 and f_{1z} take the forms $f_1 = \left(\frac{\mu_L}{\mu_v} \right)^{0.25} \cdot \frac{\rho_v}{\rho_L}$ and

$$f_{1z} = \frac{\mu_v \cdot c_L}{\mu_L \cdot c_v} \left(\frac{\lambda_L}{\lambda_v} \right)^{1.5}$$

The reference heat transfer coefficient α_{REF} is equal to the liquid-only heat transfer coefficient α_L and is calculated as

$$\alpha_L = 0.023 \left(\frac{\lambda_L}{d} \right) \text{Re}_L^{0.8} \text{Pr}_L^{1/3} \quad (5)$$

Table 1 Constant C and exponent n in Eq. (1).

	C	n
R22	2.94	1
R134a	3.18	0.68
R407C	3.24	0.66

The results of calculations using relation (3) are presented in Figure 23. As can be seen, a satisfactory consistency is obtained for the set of experimental data of R22, R134a, and R407C. Over 80% of experimental points are described by the correlation within $\pm 30\%$ error margin.

6. Conclusions

The article reviews selected results from our own experiments and those of others on different aspects of nucleate flow and pool boiling on metallic porous coatings fabricated by thermal spraying.

It has been found that aluminium deposited onto the flat heating surface has an evident superiority over other tested materials (copper, brass, molybdenum, and stainless steel). The probable reason is the very good metallic contact between the aluminium porous matrix and the substrate.

Metallic porous coating has no influence on the burnout heat fluxes, the range of them was well predicted by the Kutateladze-Zuber as well as Haramura-Katto correlations.

For certain porous coating parameters, strong hysteresis phenomena can be observed within the whole nucleate boiling regimen.

Local heat transfer enhancement, for instance in order to smooth and alleviate CTD during nucleate pool boiling on horizontal, electrically heated tube, can be obtained by partial covering of the tube surface within the region of the upper generatrix with a porous layer made of aluminium.

It was observed that independent of the tested liquid (water, methanol, refrigerant R141b), pitch-to-diameter ratio (1.7 and 2.0), and operating pressure (15–100 kPa), higher heat transfer coefficients were obtained for porous coated small tube bundles than for smooth tube bundles.

Tests conducted with continuously developed two-phase thermosiphon heat exchanger confirmed the effectiveness of porous coated tube bundles as an evaporator.

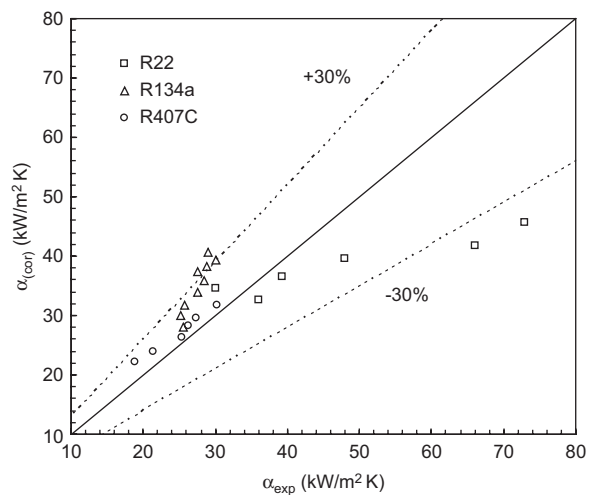

Figure 23 Predicted versus experimental data for flow boiling of pure refrigerants inside a tube with porous coating.

Finally, the results for flow boiling of pure refrigerants and refrigerant/oil mixture inside porous coated tubes displayed that application of a porous coating results in a higher, even five to six times, average heat transfer coefficient and simultaneously in lower pressure drop in comparison with smooth stainless-steel tubes for flow boiling of tested pure refrigerants R22, R134a, and R407C.

References

- Ammerman CN, You SM. Enhancing small-channel convective boiling performance using a microporous surface coating. *J Heat Transfer* 2001; 123: 976–983.
- Bergles AE. ExHFT for fourth generation heat transfer technology. *Exp Therm Fluid Sci* 2002; 26: 335–344.
- Bergles AE, Webb RL, Junkhan GH, Jensen MK. Bibliography on augmentation of convective heat and mass transfer. Report HTL-19, ISU-ERI Ames 79206, 1979.
- Bohdal T. Reasons of phase change instabilities in energy conversion media. Koszalin, Poland: Wyd. PK, 2006 (in Polish).
- Chang JY, You SM. Enhanced boiling heat transfer from microporous cylindrical surfaces in saturated FC-87 and R123. *J Heat Transfer* 1997; 119: 319–325.
- Cieśliński JT. An experimental study of nucleate pool boiling heat transfer from a flat horizontal plate covered with porous coatings. *Arch Therm* 1991; 12: 69–76.
- Cieśliński JT. Improved heat transfer to water boiling on tubes covered with porous metal coatings. *Arch Therm* 1995; 16: 93–101.
- Cieśliński JT. Study of nucleate pool boiling on metallic porous coatings. *Zesz Nauk P Gdan* 1996; 547: 3–168 (in Polish).
- Cieśliński JT. Nucleate pool boiling on porous metallic coatings. *Exp Therm Fluid Sci* 2002; 25: 557–564.
- Cieśliński JT. Modelling of nucleate boiling. Gdansk, Poland: GUT Publishers, 2005 (in Polish).
- Cieśliński JT, Dawidowicz B. Augmentation of heat transfer during flow boiling of oil-refrigerant mixtures in porous coated tube. In: Sommerfeld M, editor. 6th International Conference on Multiphase Flow. Proceedings of ICMF 2007, Leipzig, July 9–13, 2007. *Mechanische Verfahrenstechnik; Zentrum für Ingenieurwissenschaften. Halle: Martin-Luther-Universität*, 2007; paper S5.
- Cieśliński JT, Dominiczak P. A method to minimize circumferential temperature distribution outside horizontal electrically heated tube. Polish patent PL 194203, 2008.
- Cieśliński JT, Fiuk A. Thermosyphon heat exchanger. Polish patent PL 192757, 2006.
- Collier JG, Thome JR. Convective boiling and condensation, 3rd ed., Oxford: Clarendon Press, 1999.
- Czikk AM, O'Neill PS, Gotzmann CF. Nucleate boiling from porous metal films: effect of primary variables. *Advances in enhanced heat transfer. ASME Symp* 1981; 18: 109–122.
- Dominiczak P, Cieśliński JT. Circumferential temperature distribution during nucleate pool boiling outside smooth and modified horizontal tubes. *Exp Therm Fluid Sci* 2008; 33: 173–177.
- Fedders H. Messung des Wärmetübergangs beim Blasensieden von Wasser an metallischen Rohren. KFA Jülich, Jül 740 RB 1971 (in German).
- Fiuk A, Cieśliński JT. Influence of geometrical and thermophysical parameters on two-phase thermosyphon performance. In: Butrymowicz D, Gosick J, Skiepkó T, editors. HEAT'2008. Proceedings of the 5th International Conference on Transport Phenomena in Multiphase Systems, Białystok, 30 June–3 July 2008. Vol. 2. Białystok, Poland: Białystok Technical University, 2008: 317–322.
- Forrest E, Williamson E, Buongiorno J, Hu L-W, Rubner M, Cohen R. Augmentation of nucleate boiling heat transfer and critical heat flux using nanoparticle thin-film coatings. *Int J Heat Mass Transf* 2010; 53: 58–67.
- Gorenflo D, Schömann H, Sokol P, Caplanis S. Zum Einfluß der Oberflächenrauigkeit und des Rohrdurchmessers beim Blasensieden an einzelnen Glatt- und Rippenrohren. *Wärme-Stoffübertragung* 1990; 25: 265–272 (in German).
- Gupta A, Saini JS, Varma HK. Boiling heat transfer in small horizontal tube bundles at low cross-flow velocities. *Int J Heat Mass Transf* 1995; 38: 599–605.
- Haramura Y, Katto Y. A new hydrodynamic model of critical heat flux, applicable widely to both pool and forced convection boiling on submerged bodies in saturated liquids. *Int J Heat Mass Transf* 1983; 26: 389–399.
- Ikeuchi M, Yumikura T, Fujii M, Yamanaka G. Heat-transfer characteristics of an internal microporous tube with refrigerant 22 under evaporating conditions. *ASHRAE Trans* 1984; 90: 196–211.
- Kang MG. Local pool boiling coefficients on the outside surface of a horizontal tube. *J Heat Transfer* 2005; 127: 949–953.
- Kirin WK, Ziemskow BB, Malyshev AA. Influence of tube orientation and metallic coating on R12 boiling. *Cryogenic technology and conditioning. LTICHP* 1984: 99–104 (in Russian).
- Krasowski K, Cieśliński JT. Heat transfer during pool boiling of water, methanol and R141b on porous coated horizontal tube bundles. In: Poniewski ME, Alabrudziński S, editors. HEAT 2011, The 6th International Conference on Transport Phenomena in Multiphase Systems June 28–July 2, 2011, Ryn, Poland, 2011: 279–284.
- Kwark SM, Kumar R, Moreno G, Yoo J, You SM. Pool boiling characteristics of low concentration nanofluids. *Int J Heat Mass Transf* 2010a; 53: 972–981.
- Kwark SM, Moreno G, Kumar R, Moon H, You SM. Nanocoating characterization in pool boiling heat transfer of pure water. *Int J Heat Mass Transf* 2010b; 53: 4579–4587.
- Malysenko SP. Physics of boiling on porous coated surfaces and enhancing of thermal stability of equipment. In: Giot M, Mayinger F, Celata GP, editors. *Experimental Heat Transfer, Fluid Mechanics and Thermodynamics*, Edizioni ETS, Pisa, Italy, 1997: 579–591.
- Malysenko SP. The peculiarities of heat transfer crisis at two-phase flows in steam generating channels with inside porous coatings. In: Celata GP, Di Marco P, Shah RK, editors. *Two-Phase Flow Modelling and Experimentation*, Edizioni ETS, Pisa, Italy, 1999: 321–328. Also: *Russ J Thermophys* 2000; 9: 1–2.
- Mikielewicz D, Mikielewicz J, Tesmar J. Improved semi-empirical method for determination of heat transfer coefficient in flow boiling in conventional and small diameter tubes. *Int J Heat Mass Transfer* 2007; 50: 3949–3956.
- Palen JW. Heat exchanger sourcebook. Washington, DC: Hemisphere, 1986.
- Pezo M, Stevanovic VD, Stevanovic Z. A two-dimensional model of a kettle reboiler shell side thermal-hydraulics. *Int J Heat Mass Transf* 2006; 49: 1214–1224.
- Polezajev W, Kovalev SO. About modelling of CHF on porous layers. *Teploenergetika* 1990; 12: 5–9 (in Russian).
- Poniewski M. Nucleate boiling on developed micro-surfaces. Kilece, Poland: Wyd. PSw., 2001 (in Polish).
- Poniewski M. Peculiarities of boiling heat transfer on capillary-porous coverings. *Int J Therm Sci* 2004; 43: 431–443.

- Poniewski M, Thome JR. Nucleate boiling on micro-structured surfaces, Lausanne–Warsaw: Heat Transfer Research Inc., College Station, 2008, e-book: <https://www.htri.net/Public/prodsvcs/NucleateBoiling.pdf>.
- Rainey KN, Li G, You SM. Flow boiling heat transfer from plain and microporous coated surface in subcooled FC-72. *J Heat Transfer* 2001; 123: 918–925.
- Shire NF, Burnside BM, Didsbury R. Circulation velocity measurements in a model multitube kettle reboiler using laser Doppler anemometry. In: *Proceedings of the 10th International Heat Transfer Conference*. Brighton 1994, Vol. 7, 18–FB-24, 1994: 539–544.
- Styrikovich MA, Malysenko SP, Andrianov AB. Non-equilibrium phase transitions at boiling on surfaces. In: *Proceedings of the 9th International Heat Transfer Conference*. Vol. 4, 1-BO-17, Jerusalem, 1990.
- Targański W, Cieśliński JT. Evaporation of R407C/oil mixtures inside corrugated and micro-fin tubes. *Appl Therm Eng* 2007; 27: 2226–2232.
- Theofanous TG, Tu JP, Dinh AT, Dinh TN. The boiling crisis phenomenon; Part I: nucleation and nucleate boiling heat transfer. *Exp Therm Fluid Sci* 2002; 26: 775–792.
- Thome JR. *Enhanced boiling heat transfer*. New York: Hemisphere, 1990.
- Wadekar VV. A comparative study of in-tube boiling on plain and high flux coated surfaces. In: *2nd European Thermal-Sciences and 14th UIT National Heat Transfer Conference*, Edizioni ETS, 1996: 195–201.
- Vasiliev L, Zhuravlyov A, Shapovalov A. Heat transfer enhancement in mini channels with micro/nano particles deposited on a heat loaded wall. In: Stachel AA, Mikielewicz D, editors. *Proc. of the XIIIth Int Symp on Heat Transfer and Renewable Sources of Energy*, Miedzyzdroje, Poland, 9–12.09.2010. Szczecin, Poland: Wydaw. UZUT, 2010: 363–378.
- Vemuri S, Kim KJ. Pool boiling of saturated FC-72 on nano-porous surface. *Int Commun Heat Mass Transf* 2005; 32: 27–31.
- Webb RL. *Principles of enhanced heat transfer*. New York: Wiley, 1994.
- Webb RL. Odyssey of the enhanced boiling surface. *J Heat Transfer* 2004; 126: 1051–1059.
- Wójcik T. *Nucleation commencement and heat transfer hysteresis on porous coatings*. Krakow, Poland: Wyd. AGH, 2010 (in Polish).



Janusz T. Cieśliński received his MSc degree in Mechanical Engineering from Gdansk University of Technology in 1978 and received his PhD degree in 1986. He also received his DSc degree (habilitation) from Gdansk University of Technology in 1997. In 2002–2008 he served as a vice dean of the Faculty of Mechanical Engineering. In 2006–2010 he was head of

the Chair of Ecoengineering and Process Apparatus and since 2010 he has been head of the Ecoengineering and Combustion Engines Division. In 2002–2007 he was a chairman of the Multi-Phase Flow and Non-Newtonian Fluids Section of the Polish Academy of Sciences. He has been a full professor at Gdansk University of Technology since 2008.