

**Sławomir J. Ambroziak**  
**Ryszard J. Katulski**  
**Jarosław Sadowski**  
**Wojciech Siwicki**  
**Jacek Stefański**  
**Politechnika Gdańska**

## **AE G I R — A S Y N C H R O N O U S G R O U N D - B A S E D R A D I O L O C A T I O N S Y S T E M**

### **ABSTRACT**

The newest method to determine your position are satellite systems. These methods are based on the measurement of time arrival of radio signals from satellites to the receiver. Currently, the most popular system is GPS (Global Positioning System). This system is fully controlled by the Department of Defense, and only the U.S. forces and their closest allies have guaranteed accuracy offered by the system. Armies of other countries can only use the civilian version. This situation has spawned the need for an independent radiolocation system. The article describes the construction and operation of such a technology demonstrator that was developed at the Gdansk University of Technology. It was named AEGIR (according to Norse mythology: god of the seas and oceans). The main advantage of the system is to dispense with the chain organization of the reference stations, which work with each other asynchronously. This paper presents results and analysis of its effectiveness.

Keywords:

AEGIR, technology demonstrator, radiolocation system.

### **INTRODUCTION**

Global Navigation Satellite System (GNSS) is seen by terrorists or hostile countries as a high value target. Volpe Center report contains the following statement [10]: ‘During the course of its development for military use and more recent extension to many civilian uses, vulnerabilities of Global Navigation Satellite Systems (GNSS)

— in the United States the Global Positioning System (GPS) — have become apparent. The vulnerabilities arise from natural, intentional, and unintentional sources. Increasing civilian and military reliance on GNSS brings with it a vital need to identify the critical vulnerabilities to civilian users, and to develop a plan to mitigate these vulnerabilities. GNSS can also be targeted by more common criminals — computer hackers and virus writers. Therefore, there is a need for maintenance and continued development of independent radionavigation and radiolocation systems.

Based on many years of experience in the field of modern radiocommunication systems in the Department of Radiocommunication Systems and Networks at Gdansk University of Technology, in cooperation with the OBR Marine Technology Centre in Gdynia and with the support of the Hydrographic Office of Polish Navy a ground-based radiolocation system, which was named AEGIR has been developed, built and tested in real environment. In this system, all reference stations are working in an asynchronous way, so each station uses a local generator to transmit a message location and can receive signals from neighboring stations. On the basis of the received signals reference station determines the time difference between its own rhythm of work, and the neighboring reference stations. The measurement results are periodically placed in the localization message. The receiver on the basis of self-measurements and measurements from the reference stations estimates its location. Compared to existing solutions like Loran-C (Long Range Navigation-C) [8], the AEGIR system resigns chain relationship between reference stations. In the proposed system there are no supervision centers for maintenance which reduces operating costs and increases system reliability. With this approach, this system has gained new features and new functionality compared to traditional solutions.

## HYPERBOLIC SYSTEMS — TDOA METHOD

The AEGIR system is a ground based radiolocation system. Therefore a measurement method of Time Difference Of Arrival (TDOA) was chosen to estimate the position of a localizer. Suppose there are  $N$  ground stations, the coordinates for the  $i$ -th station are  $S_i = (x_{S_i}, y_{S_i})$ , where  $i = 1, \dots, N$ , and the search object's coordinates are  $M = (x_M, y_M)$ .

If we define a signal propagation time between the  $i$ -th station and the searched position in the point  $M$  as  $T_i$ , the distance  $d_i$  between the  $i$ -th station and the point  $M$  is as follow:

$$d_i = T_i \cdot c = \sqrt{(x_{Si} - x_M)^2 + (y_{Si} - y_M)^2}, \quad (1)$$

where:

$d_i$  — distance between  $i$ -th station and the point  $M$ ;

$T_i$  — the propagation delay between the  $i$ -th station and the point  $M$ ;

$C$  — velocity of wave propagation ( $3 \cdot 10^8$  m/s).

Timing differences between the  $i$ -th station  $T_i$  and a first one  $T_1$ , can be written as:

$$T_{i1} = T_i - T_1. \quad (2)$$

Differences in the distances between those stations, can be described by the following relationship:

$$d_{i1} = T_{i1} \cdot c = d_i - d_1. \quad (3)$$

After putting equation (1) in equation (3) we obtain hyperbolic equation:

$$d_{i1} = \sqrt{(x_{Si} - x_M)^2 + (y_{Si} - y_M)^2} - \sqrt{(x_{S1} - x_M)^2 + (y_{S1} - y_M)^2}. \quad (4)$$

Equation 4 presents the difference in distance between the first and  $i$ -th station.

Determination of the distance difference between another pair of base stations generates the second hyperbola and a point of their intersection gives us a position. There are many algorithms [1, 3–5], which allow to determine the coordinates, however for the purpose of the system the Chan method [1] was chosen. In case of reception from only three stations, Chan's algorithm will result in a set of two coordinate values. Only one of them is correct and the other one lies outside the present area [9].

## ASYNCHRONOUS TDOA METHOD

The principle of asynchronous TDOA method can be illustrated as follows. Assume that we have three reference stations positioned as in figure 1.

Propagation time from the stations to the position in the point  $M$  is respectively  $T_1$ ,  $T_2$  and  $T_3$  and the distance between them is respectively  $d_1$ ,  $d_2$  and  $d_3$ . Each station has coordinates as follows:  $S1 = (x_{S1}, y_{S1})$ ,  $S2 = (x_{S2}, y_{S2})$  and  $S3 = (x_{S3}, y_{S3})$ .

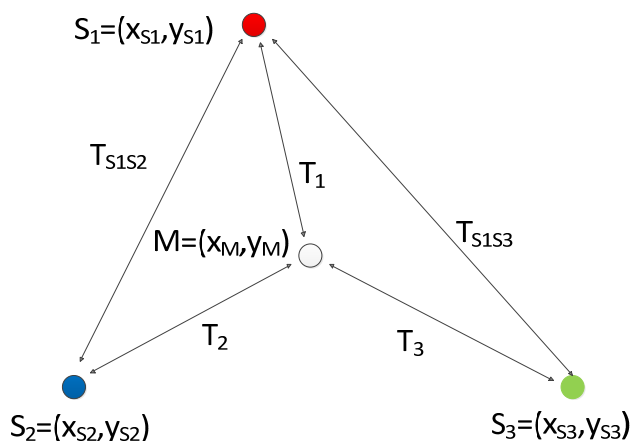

Fig. 1. Deployment of ground stations to illustrate the method of TDOA

Source: own study.

The stations transmit a reference signal, for simplicity, as an impulse, but time of broadcasting these impulses, as shown in figure 2a, is random. The stations have the ability to ‘listen to’ neighbouring stations. This is illustrated in figure 2b. Reference station designated as  $S_1$  receives signal from other two stations:  $S_2$  and  $S_3$ , and calculates the time difference between its own and these stations’ signals ( $nT_{21}$  and  $nT_{31}$ ). These time differences are then sent to the localizer. The localizer, at  $M$  point, (pictured in fig. 2c) sets its own time difference between the received impulses from the reference station ( $dT_{21}$  and  $dT_{31}$ ). Additionally, each ground station sends to the localizer its own coordinates (respectively  $x_{S1}$ ,  $y_{S1}$  — the coordinates of the first station;  $x_{S2}$ ,  $y_{S2}$  — coordinates of the second station;  $x_{S3}$  and  $y_{S3}$  — coordinates of the third station), so that the localizer calculates the propagation time between the reference stations ( $T_{S1S2}$ ,  $T_{S1S3}$ ).

Taking into account all sent data, the localizer calculates a real difference in propagation time between stations, which present the following equations:

$$\begin{aligned} T_{21} &= nT_{21} - dT_{21} - T_{S1S2} \\ T_{31} &= nT_{31} - dT_{31} - T_{S1S3} \end{aligned} \quad (5)$$

The time differences defined in this manner allow to determine coordinates of searched object  $M$  using one of the sets of algorithms [1, 3–5].

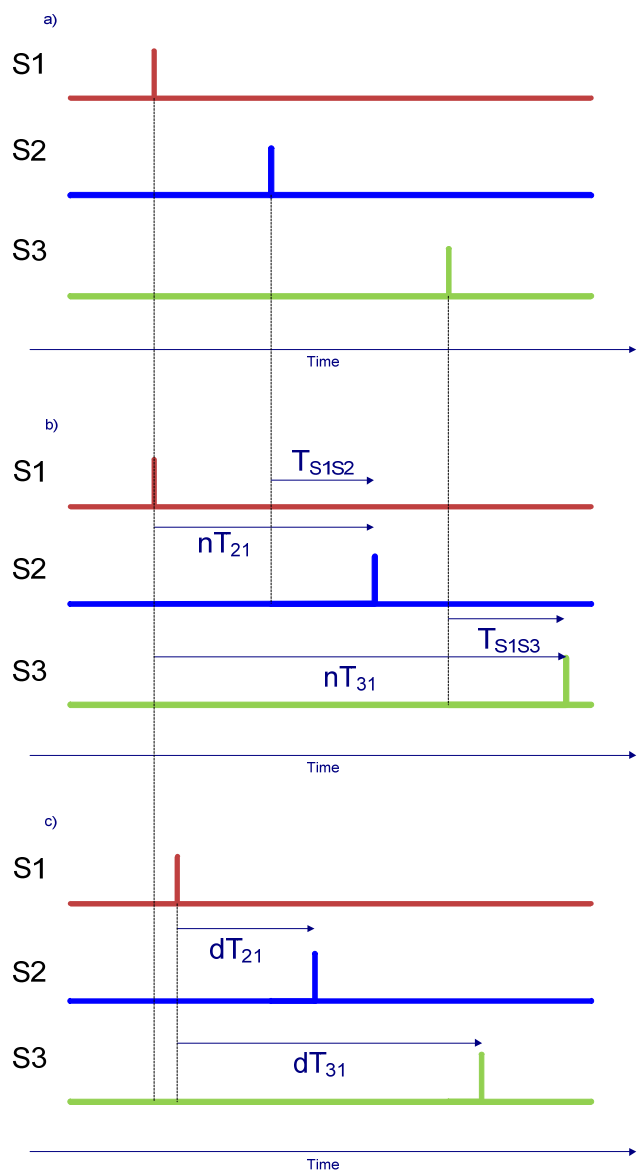

Fig. 2. Timing between signals broadcasted by base stations in an asynchronous system:  
 a) the moment of broadcasting impulses by the stations;  
 b) the time of receipt of impulses by S1 station;  
 c) the time of receipt of impulses by the localizer (M point)

Source: Patent application No P393181, Asynchronous system and method for determining position of persons and/or objects (in Polish), December 2010; European patent application No EP11460023, Asynchronous system and method for estimating position of persons and/or objects, May 2011.

## HARDWARE IMPLEMENTATION

The AEGIR system consists of a localizer and reference stations. The localizer has been made in the technology of Software Defined Radio [6]. It consists of: an antenna, a broadband receiver, an analogue to digital converter (in the form of data acquisition card) and digital signal processor (in form of a PC). This approach allows to shape flexibly functionality of the localizer. The block diagram of a localizer are presented in figure 3a.

Ground stations, as it was mentioned before, have the ability to ‘listen to’ neighbouring stations. It is assumed that the system should consist of such stations (Master ones) only. However for demonstrable purposes, only one Master station is required. Therefore two types of ground stations were created: broadcasting stations (Slave type) and broadcasting and listening ones (Master type).

The block diagram of a Slave station are shown in figure 3b. The main element of the station is a radio signal generator, whose task is to broadcast modulated signal with data that are generated by industrial computer.

The block diagram of the last element of the described system — Master station — are shown in figure 3c. Master station is a combination of a localizer and a Slave station. The task of the receiver is to listen to a nearby station and to determine difference in synchronization between reference signal and signals from the neighbouring stations.

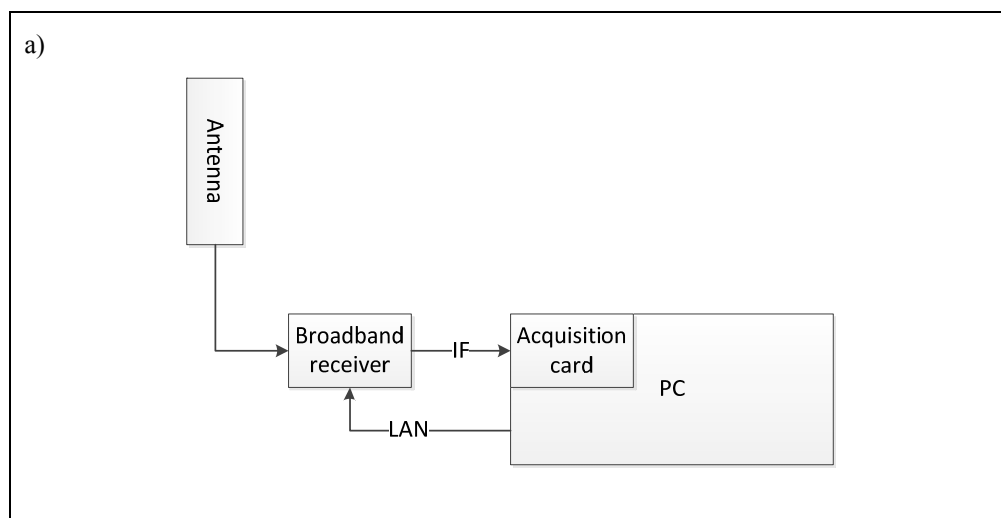

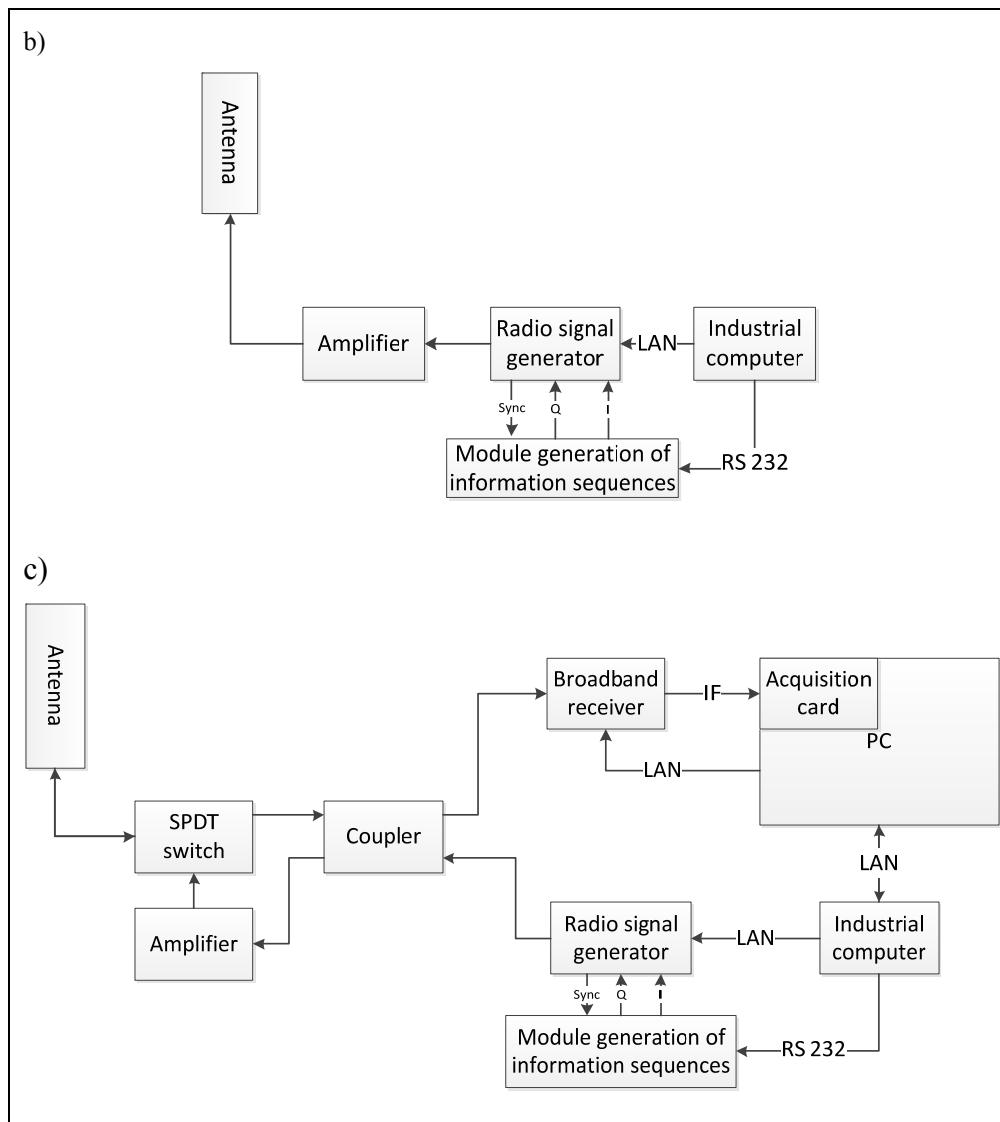

Fig. 3. The block diagram of: a) localizer; b) slave station; c) master station

Source: own study.

### RADIO PARAMETERS

Analysing the bandwidth VHF/UHF (Very High Frequency/Ultra High Frequency) among resources available for civil use, it was decided to build system

using DS-CDMA technology (Direct Sequence Code Division Multiple Access) in the band 430 MHz, with the following parameters:

- carrier frequency 431.5 MHz;
- bandwidth of the transmission channel 1 MHz;
- sampling frequency baseband signal 4 MHz;
- the location information transmission rate 1 kb/s;
- QPSK modulation (Quadrature Phase Shift Keying).

## TESTS AND RESULTS

The developed technology demonstrator was tested at Bay of Gdansk. Three reference station has been placed: first — on top of the OBR Marine Technology Centre building, second — on the top of the lighthouse in Hel and third — on the top of the lighthouse in Gdansk Nowy Port (localization of these location is illustrated in figure 4). The localizer was placed on a small watercraft.



Fig. 4. Deployment of ground stations (arrows) and a path of GPS and GLONASS positions (dotted line) and readings of autonomous AEGIR system (dots)

Source: own study.



During field tests a position from a satellite navigation system was recorded with the use of a Javad Alpha receiver, which enables simultaneous position from both American (GPS) and Russian (GLONASS) systems.

The effects of our tests are illustrated by the visualization shown in figure 4, created with use of Google Earth software. The dotted line represents the path of positions received from the satellite systems GPS/GLONASS, and the dots represent the calculated positions of the ground-based system.

Analysing the visualization shown in figure 4 it can be observed how accurate the route travelled by the vessel was reconstructed by points calculated by the autonomous radiolocation system — AEGIR.

Based on studies, an absolute error has been determined, which is defined as follows:

$$\Delta d = \sqrt{(x - x_m)^2 + (y - y_m)^2}, \quad (6)$$

where:

$(x, y)$  — coordinates from satellite systems (GPS and GONASS);

$(x_m, y_m)$  — coordinates form AEGIR system.

After completing the measurements, average error (relative to the position shown by the GPS/GLONASS) was obtained at 46 m. Distribution function of the results is illustrated in figure 5.

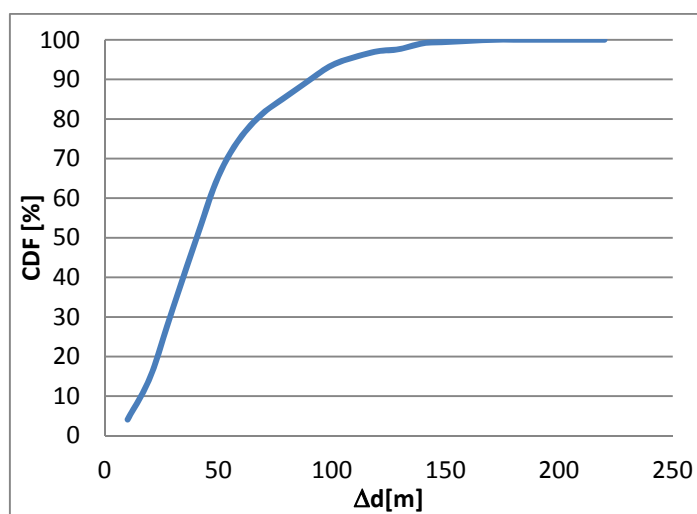

Fig. 5. Distribution of results

Source: own study.

Analyzing the distribution function in figure 5 it can be observed, that in 90% of all measured cases the difference distance is below 100 m.

It should be emphasized that the results have been obtained at 1 MHz bandwidth. The accuracy of location estimation in the TDOA method, which measures the difference in distance between the object and neighboring reference stations, are implemented on the basis of maximum correlation function (AEGIR system determines the maximum string scattering correlation function) depends on the sample rate received signals at the receiver. If the sampling frequency is increased, the accuracy of TDOA method is greater. For a wider bandwidth the results would be significantly better. Figure 6 shows the accuracy of the theoretical results using more bandwidth (and faster signal sampling in a localizer).

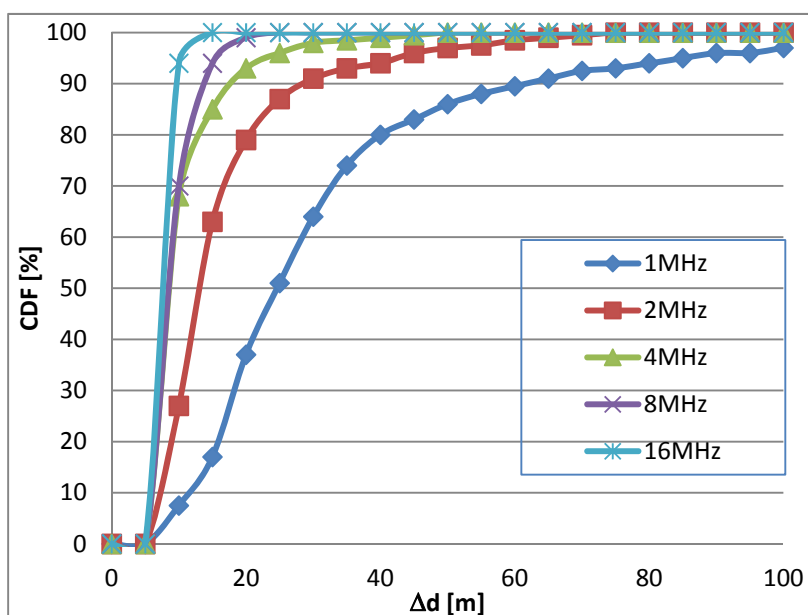

Fig. 6. Theoretical distribution depending on system bandwidth

Source: own study.

The system was also tested in a less favourable configuration. Ground stations were set along the coastline. They have been installed on three lighthouses: Czołpino, Stilo and Rozewie. Visualization of this configuration is illustrated in figure 7. The distance between reference stations is around 35–40 km. The vessel was sailing at a distance of 8–10 km from the shore.

The system also works well at worse geometry of ground station.

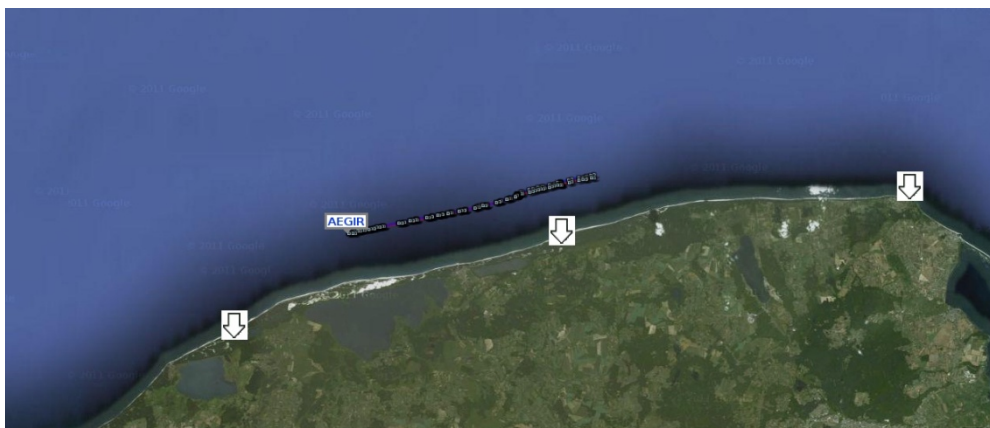

Fig. 7. Visualisation of AEGIR path, ground stations placed along the shore at lighthouses (Czołpino, Stilo and Rozewie)

Source: own study.

## CONCLUSION

Modern radiolocation systems for Navy vessels should be completely independent of other radiolocation/navigation systems as the GPS, GLONASS or in the future GALILEO. A new method for asynchronous operation of such a system has been developed. It resigns chain organization of reference stations. An important issue in the radiolocation system is its ability to obtain the most accurate information on location of the localized object. It is well known that the distance between ground stations is determined by the shape of the coast and this geometry affects estimation. In such conditions radio link parameters should be selected to ensure appropriate resolution measurements of reference signals, which directly affects the accuracy of locating objects. It was decided, therefore, to use a CDMA channel access. This method, due to the low density of the spectral signals of the radio channel, it is preferred to use in special applications, due to the possibility of receiving signals that are below the thermal noise level, and is also immune to narrowband interference (intentional or accidental). Due to the occupied bandwidth (in final version of the system it is proposed 10 MHz bandwidth) carrier frequency was placed in the UHF band. In the target solution, the choice of carrier frequency is dependent on: the technical feasibility of the transceivers, frequency and resources available, propagation conditions affecting the potential range of the system. The last, but not least

important issue was to ensure maintenance-free and reliable operation of the various components of the system. It is all about minimizing operator interaction and reference station locator of devices. The role of the operator should be reduced only to the supervision and control of the accuracy of the system.

### **Acknowledgments**

The described research was financed from funds for science in the years 2008–2011 as a development project.

### **REFERENCES**

- [1] Chan Y. T., Ho K. C., *A Simple and Efficient Estimator for Hiperbolic Location*, 'IEEE Transactions on Signal Processing', August 1994, Vol. 42, No 8, pp. 1905–1915.
- [2] European patent application No EP11460023, *Asynchronous system and method for estimating position of persons and/or objects*, May 2011.
- [3] Fang B. T., *Simple Solution for Hiperbolic and Related Position Fixes*, 'IEEE Trans. on Aero. and Elec. Systems', 1990, Vol. 26, No 5, pp. 748–753.
- [4] Foy W. H., *Position-Location Solutions by Taylor-Series Estimation*, 'IEEE Trans. on Aero. and Elec. Systems', 1976, Vol. AES-12, No 2, pp. 187–194.
- [5] Friedlander B., *A Passive Localization Algorithm and Its Accuracy Analysis*, 'IEEE Jour. of Oceanic Engineer.', 1987, Vol. OE-12, No 1, pp. 234–245.
- [6] Katulski R., Marczak. A., Stefański J., *Software Radio Technology* (in Polish), 'Telecommunication Review and Telecommunication News', 2004, No 10, pp. 402–406.
- [7] Patent application No P393181, *Asynchronous system and method for determining position of persons and/or objects* (in Polish), December 2010.
- [8] *Specification of the Transmitted LORAN-C Signal*, U.S. Department of Transportation and U.S. Coast Guard, May 1994.
- [9] Stefański J., *Methods' analysis for position estimation of movable terminal in a multipath environment* (in Polish), KKRRiT 2009, 'Telecommunication Review and Telecommunication News', 2009, No 6, pp. 364–367.
- [10] *Vulnerability Assessment of the U.S. Transportation Infrastructure that Relies on GPS*, John A. Volpe National Transportations Systems Center, USA, 2001.

## **AEGIR — ASYNCHRONICZNY NAZIEMNY SYSTEM RADIOLOKACYJNY**

### **STRESZCZENIE**

Najnowszą metodą określania pozycji są systemy satelitarne, oparte na pomiarze czasu przejścia sygnału od satelitów do odbiornika. Obecnie najpopularniejszym systemem jest GPS. Znajduje się on pod pełną kontrolą Departamentu Obrony i tylko siły zbrojne USA oraz ich najbliżsi sojusznicy mają zagwarantowaną dokładność oferowaną przez system. Armie innych krajów mogą korzystać tylko z wersji cywilnej. Powoduje to zapotrzebowanie na niezależny system radiolokacyjny. Artykuł opisuje budowę i działanie demonstratora technologii, który został opracowany na Politechnice Gdańskiej pod nazwą AEGIR (według staroskandynawskiej mitologii: bóg mórz i oceanów). Główną zaletą systemu jest brak łańcuchowej organizacji stacji referencyjnych, które współpracują ze sobą asynchronicznie. Artykuł przedstawia wyniki i analizę efektywności tego systemu.

#### Słowa kluczowe:

AEGIR, demonstrator technologii, system radiolokacyjny.