

DOPPLER EFFECT IN THE CW FM SONAR

**JACEK MARSZAL, ROMAN SALAMON, KRZYSZTOF ZACHARIASZ,
ALEKSANDER SCHMIDT**

Gdansk University of Technology
11/12, G. Narutowicza St., 80-233 Gdansk, Poland
jacek.marszal@eti.pg.gda.pl

When sonars are used for military purposes they have to ensure unobtrusive operation, a feature that can be potentially secured by 'silent sonars' or continuous wave frequency modulation sonars (CW FM sonars). The article presents how these sonars operate and identifies the relations between their parameters. The Doppler effect and its impact on the CW FM sonar are studied to identify how it affects the sonar's parameters. The results of simplified theoretical calculations are supported with results of computer simulations of a more realistic model.

INTRODUCTION

The downside of conventional sonars used for military applications is that they can be easily detected by alien systems listening for sounding signals. If identified, the signals may reveal their source. Failure to use discreet sonars may have a number of military consequences, all of which are negative. This is why it is important to make sonars difficult to detect. This paper presents one of the possible ways of achieving that, i.e. by using continuous wave frequency modulation sonar, the CW FM sonar. The sonar is the equivalent of the CW FM radar successfully used by the navy and air forces, [1]. While both are similar, the systems differ significantly which leads to some important limitations of the sonar's major parameters.

First, we will answer the question of what to do to make the sounding signal of a sonar (or radar) more difficult to detect. We obtain the answer by analysing the signal detection conditions in a system designed to detect sounding signals. The worst case scenario for us and the best case scenario for our enemy is when the receiver in the system can operate more or less like the sonar's receiver and ensure optimal detection. In an extreme case like this our actions will be ineffective because by making detection more difficult for the enemy we are downgrading the parameters of the sonar (e.g. by reducing its range). Even in a bad situation like this, the enemy must have exact knowledge of all key parameters of our sounding signal

for detection to succeed. Because this is not very likely let us assume that the enemy will learn about the parameters of our sounding signal only after the signal has been received and analysed. This is why our efforts should be designed to make the reception and analysis of the sounding signal as difficult as possible. As we know from theory of detection the optimal detector of a signal with unknown parameters against a background of white noise is the energy detector [2]. Detection involves a comparison of the received signal's energy in a specific time interval when the sounding signal is present and absent. A detector like this can be effective when the sounding signal is pulsating. Some time intervals will only produce noise and others will produce a sounding signal and noise. In the latter case energy levels are higher which may lead to a successful detection of the sounding signal. When the signal is continuous, the energy of the signal with noise is constant in practically all time intervals making it more difficult or impossible to identify a sounding signal. This explains why it is important to use a continuous sounding signal. Detection will be more difficult if the sounding signal has little power which does not cause a distinct increase in average noise power in the listening band.

When the sonar's signal has a constant power, the power of the received signal depends on the distance between the receiver and transmitter. Even for a relatively low power of the signal, at a certain distance, the power of the received signal will be strong enough to enable detection by the enemy's receiver. As a result, sonar will remain unobtrusive only at distances that go beyond a certain limit. Our goal with 'silent' CW FM sonars is to significantly reduce that limit compared to pulse sonars.

Our second assumption is that the enemy's listening system performs spectral analysis of the signals received. With low power of the received signal and a narrow spectrum, a frequency analysis can detect the signal within the noise because its energy (power) is concentrated in a small fragment of the spectrum. The conclusion is that the band of the sounding signal should be sufficiently wide to ensure that its energy is dispersed over a wider spectrum fragment making detection more difficult. There is a simple way to achieve this, i.e. by using frequency modulation.

To recap, continuous frequency modulation signals meet the basic requirements expected of silent sonars.

1. THE PRINCIPLE OF CW FM SONAR OPERATION

In the simplest version, the sonar's transmitter emits a continuous periodic acoustic signal of T duration. Each interval emits a signal with linear frequency modulation with mid frequency f_0 and band width B as illustrated in Fig. 1.

Instantaneous frequency of the signal can be written down in time interval $(0, T)$ as:

$$f(t) = f_0 - B/2 + B \frac{t}{T} \quad (1)$$

and in the successive intervals it becomes a copy of that relation delayed by nT .

Let us assume that the emitted signal is propagated in an ideal unlimited medium and bounces off a stationary object at a distance of R from the transmitter. If the location of the receiver matches the location of the transmitter, the receiver will receive the echo signal which is a reduced and delayed copy of the emitted signal. Delay τ is equal to:

$$\tau = \frac{2R}{c} \quad (2)$$

where c is the velocity of sound in water.

Frequency f_e of the echo signal is then equal to:

$$f_e(t) = f_0 - B/2 + B \frac{t - \tau}{T} \tag{3}$$

The difference $F(t) = f(t) - f_e(t)$ in the frequencies of the emitted signal and echo signal is determined continuously in the receiver. Formulas (1) and (3) show that the difference is:

$$F = B \frac{\tau}{T} \tag{4}$$

i.e. it is constant for a stationary target.

The above formula is right in time interval $\tau < t < T$ and in consecutive analogous intervals. The difference between the frequencies during time interval $0 < t < \tau$ and similar periodically recurring intervals is equal to $F - B$ as shown in Fig. 1.

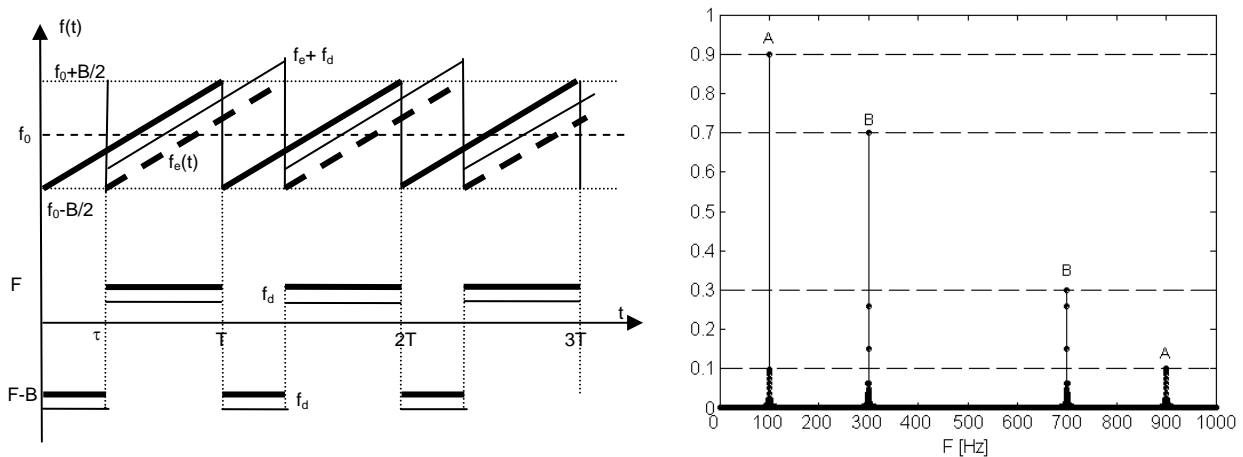

Fig. 1. The frequency of the emitted signal, echo signal, differential frequency and the Doppler shift two targets located at: A – 750 m, B – 2250 m ($f_0 = 10$ kHz, $B = 1$ kHz, $T = 10$ s, $c = 1.5$ km/s)

By measuring differential frequency F with formulas (2) and (4) we can determine the distance to target R :

$$R = \frac{cT}{2B} F \tag{5}$$

Because differential frequency F may not be greater than bandwidth B , the range of sonar R_z does not go beyond the limit:

$$R_z \leq \frac{cT}{2} \tag{6}$$

In practice the range is much smaller because increases in delay τ reduce the time intervals used for measuring the frequency. As a result, spectral lines during spectral analysis are reduced and deteriorate the signal to noise ratio. It is possible to remove this limitation by using $F-B$ frequency for calculating the distances. When delay τ increases, the appropriate spectral line grows to a point where the sum of the heights of both lines is constant. This can be seen in Fig. 2 which shows the spectrum of the differential signal originating from two identical targets at two different distances.

To eliminate the impact of the Doppler effect as described further, radiolocation uses frequency modulated signals as shown in Fig. 3.

The differential frequency for a stationary target during time intervals (τ, T) and intervals periodically recurring is F or $-F$. The differential signal during time interval $(0, \tau)$ and its periodically recurring intervals undergoes frequency modulation which is linear and ascending or descending. As a result, it becomes a chirp type signal. The period of the sounding signal and differential signal now amounts to $2T$. Although $2T$ is now longer, this does not affect range R_z whose maximum is still expressed with formula (6). When the delay is $\tau = T$ the differential signal is exclusively a chirp type signal. An example of the spectrum of a differential signal with a high delay τ is shown in Fig. 4.

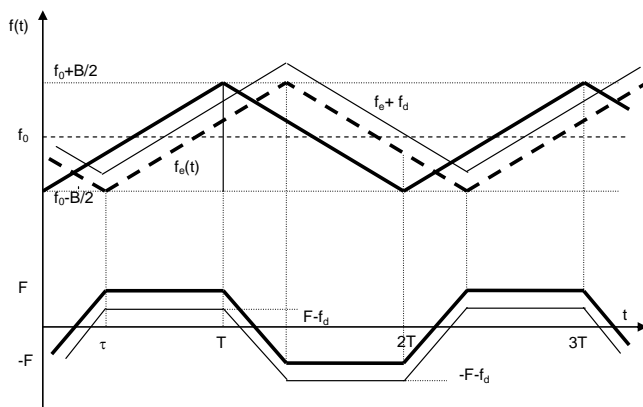

Fig. 3. The frequency of the emitted signal, echo signal and differential frequency in second version of the system

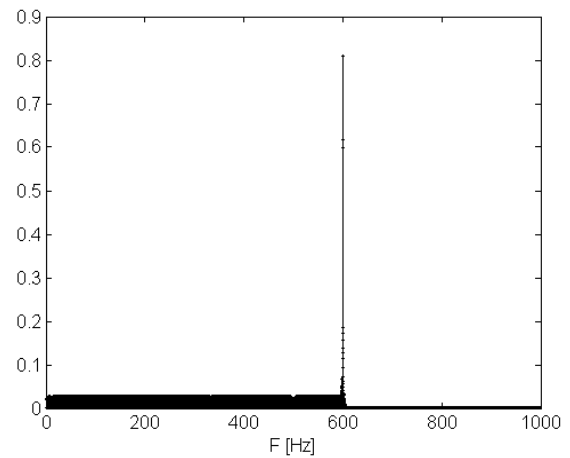

Fig. 4. Differential frequency spectrum in second version of the system ($f_0 = 10$ kHz, $B=1$ kHz, $T = 10$ s, $c=1.5$ km/s, $R_0 = 4.5$ km)

As you can see in Fig. 4 the chirp signal spectrum occurs in frequencies in band $(0, F/)$ as shown in Fig. 3.

2. DOPPLER EFFECT IN THE CW FM SONAR

The previous application of the CW FM sonar was with stationary sonar and a stationary target. If either the sonar or the target or both are moving relative to each other with velocity v , the result, as we know, is the Doppler effect. The echo signal frequency changes and is different from when the sonar and target are stationary. The results of the shift are shown in Fig. 1 and Fig. 3. When the relation between mid frequency f_0 and bandwidth B is high, the simplified shift in echo signal frequency is equal to, [1, 3]:

$$f_d \cong \frac{2v}{c} f_0 \tag{7}$$

in the first version of the system, differential frequency is now:

$$F = F_0 + f_d = B \frac{\tau}{T} + \frac{2v}{c} f_0 \tag{8}$$

where F_0 is differential frequency for stationary objects. The + sign occurs when the target is approaching the sonar; otherwise the formula above will include the - sign.

As shown in formulas (5) and (8) the distance to the target determined on the basis of differential frequency is:

$$R = \frac{cT}{2B} \left(B \frac{\tau}{T} + \frac{2v}{c} f_0 \right) = \frac{c\tau}{2} + \frac{Tf_0}{B} v = R_o + \frac{Tf_0}{B} v \tag{9}$$

As you can see from the above formula, the calculated value of distance R is different from distance R_o from a stationary target and sonar. The error in evaluating the distance is equal to:

$$\Delta R = \frac{Tf_0}{B} v = 2R_z \frac{f_0}{B} \frac{v}{c} \tag{10}$$

Range R_z and quotient f_0/B are the constant parameters of a specific sonar. As a result, the evaluation error is a function of the v/c relation. As an example, for a range of $R_z = 10$ km, $f_0/B = 5$ and velocity $v = 15$ m/s the error in the distance is $\Delta R = 1$ km. Obviously, this is not acceptable, especially because the error is constant and does not depend on the distance from the target.

The relative error in the distance is equal to:

$$\delta R = \frac{\Delta R}{R_o} = \frac{2Tf_0}{\tau B} \frac{v}{c} \tag{11}$$

The maximum range is $T/\tau=1$. In underwater acoustics the minimal quotient can be $f_0/B = 5$. For a sonar featuring such extremely good parameters, the relative error is minimal and approximately equal to:

$$\delta R_{min} \cong 10 \frac{v}{c} \tag{12}$$

If velocity is $v=15$ m/s, the error will be 10% of the maximum assumed range. If the distance to the target is shorter, the relative error will grow in the proportion of T/τ .

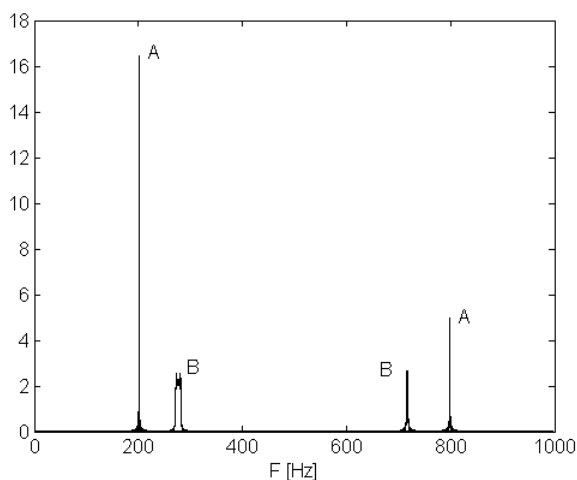

Fig. 5. Spectrum of differential frequencies: A – $v = 0$ m/s, B – $v = 10$ m/s. ($f_0 = 10$ kHz, $B = 1$ kHz, $T = 10$ s, $c = 1.5$ km/s, $R_0 = 1.5$ km)

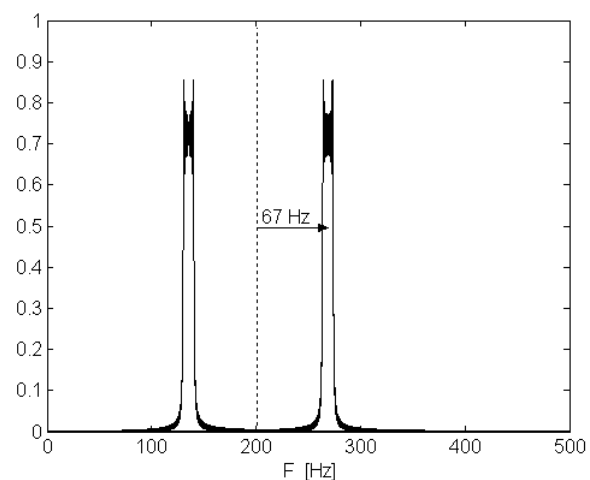

Fig. 6. Spectrum of differential frequencies for increasing and decreasing frequencies of sounding signals

Fig. 5 shows the spectrum of the signal's differential frequency with the Doppler shift and $B = 0.1f_0$. To compare, the same figure shows the spectrum of the same target but in this case it is stationary.

The figure shows four important features of differential frequency spectrum determined for a moving target. First, you can see a shift in the spectrum relative to the differential frequency of a stationary target. If the data are as specified in the caption, the shift according to formula (7) is about 67 Hz. Second, the differential signal spectrum does not come as a single distinct line, but instead has a more rectangular shape which is typical for signals with linear frequency modulation. This shape is further explained in the publication [4]. Third, the maximal values of differential frequency spectrums are clearly lower than the heights of the relevant spectral lines of a stationary target. Fourth, the proportion between the height of the lines with frequencies F and $F-B$ which occurs for a stationary target does not apply to moving targets.

All the above properties of a moving target's differential frequency spectrum have a negative effect on the performance of sonar. Due to the shift of the spectrum sonars give the wrong distance to the target, the shape of the spectrum makes differential frequency more difficult to determine, lower spectrum height makes detection more difficult and the disproportion between frequency F and $F-B$ lines means that height lines in the function of the distance to the target will remain different.

In version two of the system as frequencies start to rise (τ, T range) differential frequency is approximately equal to:

$$F_i = F_0 + f_d \quad (13)$$

As frequencies start to descend ($T+\tau, T$ range) the frequency is:

$$F_d = F_0 - f_d \quad (14)$$

Using formulas:

$$\frac{1}{2}(F_i - F_d) = f_d \quad \frac{1}{2}(F_i + F_d) = F_0 \quad (15)$$

we can determine the Doppler shift and then velocity v and frequency F_0 and finally the distance to the target.

Fig. 6 shows the spectrum of differential frequencies for Doppler shift signals for the data given in Fig. 5.

Relation (15) can be used to eliminate the Doppler shift, however, we have to be able to clearly identify the right pairs of spectral lines when monitoring more than one target. This can be done if the height of spectral lines of different targets is significantly different. You can see it in Fig. 7 where three targets have different target strengths and move at different speeds.

In a real sonar the height of spectral lines depends not only on the target strength but also on the distance from the sonar and the sound of the sea. Distance can be offset by changing the height of lines with higher differential frequencies. When the signal to noise ratio is low, spectral lines can display strong differences in height making it more difficult or even impossible to identify lines. This is illustrated in Fig. 8 which shows the spectrum from two identical targets with a low signal to noise ratio.

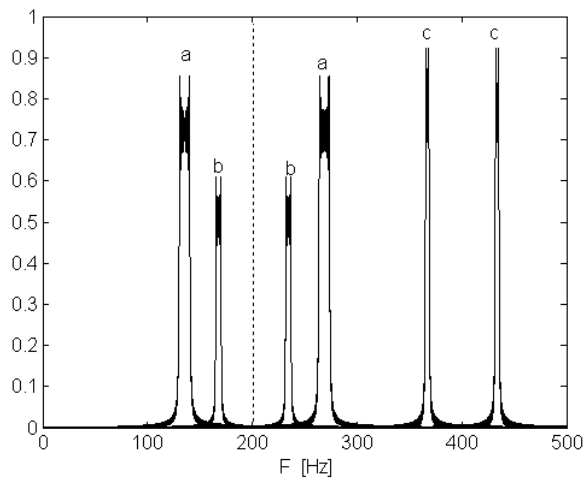

Fig. 7. Spectrum of differential frequencies for three different targets: **a** – $R_0=1.5$ km, $v=10$ m/s, $\text{ampl.} = 1$, **b** – $R_0=1.5$ km, $v=5$ m/s, $\text{ampl.} = 0.5$, **c** – $R_0=3$ km, $v=5$ m/s, $\text{ampl.} = 0.75$

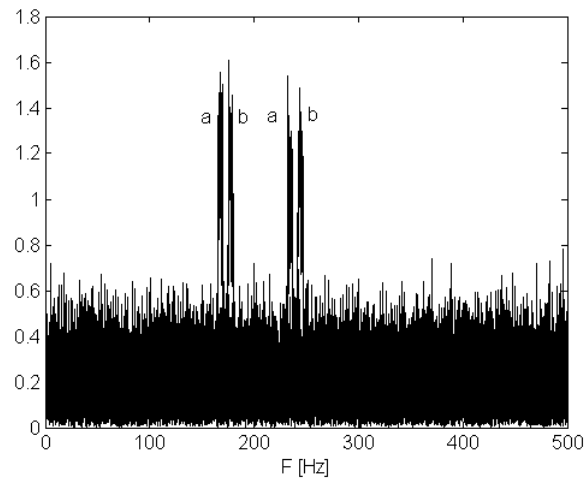

Fig. 8. Spectrum of differential frequencies for two identical targets: **a** – $R_0=1.5$ km, $T = 10$ s, $v = 5$ m/s, **b** – $R_0=1.575$ km ($f_0 = 10$ kHz, $B = 1$ kHz, $T = 10$ s, $v = 5$ m/s)

3. CONCLUSIONS

The analysis above has demonstrated that the Doppler effect is a critical element that must be considered when designing and operating CW FM sonars. The fundamental problem is the error in target distance which is proportional to target velocity. In addition, the Doppler effect deteriorates detection conditions as the line of differential frequency decreases while target velocity is increasing. This leads to the following conclusions:

1. CW FM sonars can be designed and built in the first of the above versions and used for stationary target detection. The effects of the sonar's own speed can be counterbalanced using its speed vector data.
2. CW FM sonars can be built in the first version as small range sonars for detecting slow moving targets. The error in distance measurement is proportional to the maximum range which depends on the sounding signal's period. As an example, if we assume that maximal range $R_z = 500$ m and $f_0/B = 5$, the error in distance measurement is equal to 3.3 m for target velocity $v = 1$ m/s. This error is acceptable in some situations, especially when the targets are at a distance close to the sonar's range. The relative error in the measurement is in this case about 1%.
3. Please note that the error can be reduced using a high relative spectrum bandwidth of signal B/f_0 .
4. CW FM sonars make sense if they can compensate for the Doppler shift; otherwise they will have the same limitations as in the first simpler version of the sonar. Doppler effect compensation requires a complex spectrum analysis to identify the right pairs of lines. What makes the identification difficult is the low signal to noise ratio, typically present in targets near the sonar's range.
5. In both versions of the CW FM sonar there is a conflict involving period T . To help with detection, period T should be as long as possible because when the sounding signal's power is constant (i.e. as low as possible) the signal has the desired high level of energy. To help with eliminating errors in reading the distance, period T should be short. As a result, a compromise is needed between these two conflicting needs.

Finally, our answer to the question why CW FM radars ensure very good parameters and CW FM sonars do not. This is because the velocity of an acoustic wave is very low compared to the velocity of an electromagnetic wave. This is demonstrated on the example of a silent marine radar CRM-203 manufactured by the Przemysłowy Instytut Telekomunikacji S. A. (Industrial Institute of Telecommunications) [5]. The radar has $f_0/B \cong 200$ which for range $R_z = 30$ km gives the distance measurement error at (formula 10) $\Delta R = v/25$. (R [m], v [m/s]). For target speed $v = 25$ m/s the error in determining the distance is only 1 m which is negligible. Even with a significant increase in the range and velocity the error in distance estimation is not substantial. Relative Doppler shifts in CW FM radars are so small that they cannot be measured with the Fourier transform and a two dimensional Fourier transform [5] is used to determine target velocity.

REFERENCES

- [1] Skolnik M., Radar Handbook, Second Edition, Mc Graw-Hill, 1990.
- [2] Salamon R., Systemy hydrolokacyjne, Wyd. GTN Gdansk 2006.
- [3] Wang Bu-Chin, Digital Signal Processing Techniques and Applications In Radar Image Processing, Willey & Sons Inc., 2008.
- [4] Salamon R., Marszal J., Schmidt J., Rudnicki A., Silent Sonar with Matched Filtration, Hydroacoustics, 2011, Vol. 14.
- [5] <http://www.pit.gda.pl/PL/index.php?page=radary-fmcw>.