

Comparison of state feedback and PID control of pressurizer water level in nuclear power plant

MARIUSZ CZAPLIŃSKI, PAWEŁ SOKÓLSKI, KAZIMIERZ DUZINKIEWICZ, ROBERT PIOTROWSKI
and TOMASZ RUTKOWSKI

The pressurizer water level control system in nuclear power plant with pressurized water reactor (PWR) is responsible for coolant mass balance. The main control goal is to stabilize the water level at a reference value and to suppress the effect of time-varying disturbances (e.g. coolant leakage in primary circuit pipeline system). In the process of PWR power plant operation incorrect water level may disturb pressure control or may cause damage to electric heaters which could threaten plant security and stability. In modern reactors standard PID controllers are used to control water level in a pressurizer. This paper describes the performance of state feedback integral controller (SFIC) with reduced-order Luenberger state observer designed for water level control in a pressurizer and compares it to the standard PID controller. All steps from modeling of a pressurizer through control design to implementation and simulation testing in Matlab/Simulink environment are detailed in the paper.

Key words: nuclear power plant, pressurizer, state feedback, water level control, integral control, reduced-order Luenberger state observer, PID control

1. Introduction

The current increase in consumption of fossil fuels such as coal, lignite, petroleum, and natural gas leads to shrinking natural resources. This phenomenon requires the development of new energy policies taking into account renewable energy and nuclear power, which provides energetic security for years to come.

Nuclear power is based on the obtaining energy from heavy fission elements nuclei, especially uranium, which possesses great concentration of energy therein. Uranium fuel constitutes one of the most common elements on earth. However, there is little uranium ore deposits, which would be cost-effective in extraction using current technology. Ecological, economical and technological factors make nuclear power, after years of oblivion, becomes the center of attention, despite public concerns related to the recent nuclear

The Authors are with Gdansk University of Technology, Faculty of Electrical and Control Engineering, G. Narutowicza 11/12, 280-233 Gdansk, Poland. E-mails: mczaplinski@eia.pg.gda.pl, psokol-ski@eia.pg.gda.pl, k.duzinkiewicz@eia.pg.gda.pl, r.piotrowski@eia.pg.gda.pl, t.rutkowski@eia.pg.gda.pl

This work was supported by the National Centre for Research and Development under Strategic Research Project No. SP/J/10/176450/12. The authors wish to express their thanks for the support.

Received 22.07.2013.

accident in Japan's Fukushima Nuclear Power Plant after the earthquake in 2011. The principle of operation of nuclear power plants is based on the process of nuclear energy change as a result of nuclear fission. Energy conversion takes place in three stages: conversion of nuclear energy into thermal energy - which takes place in the primary circuit, the conversion of heat energy into mechanical energy - which takes place in the secondary circuit and the conversion of mechanical energy into electrical energy - taking place in electric generator.

In the case of pressurized water reactor nuclear energy conversion into heat occurs by fission chain reaction in the reactor core. The resulting thermal energy is received by the coolant flowing through the reactor core (Fig. 1).

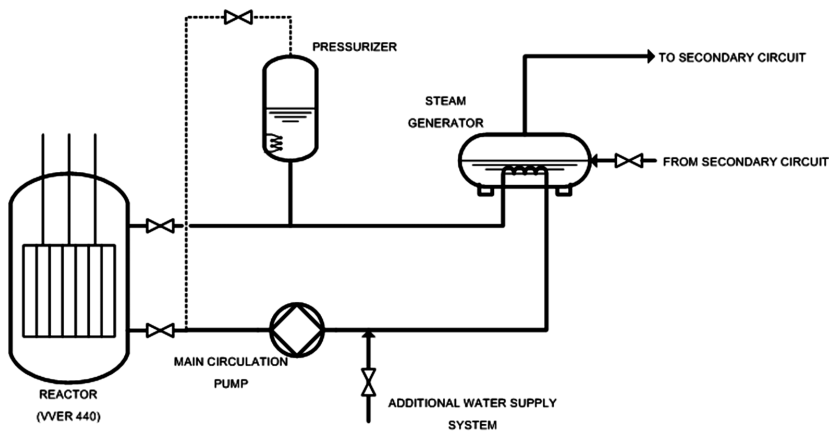

Figure 1. Primary circuit flowchart.

In the closed primary circuit consisting of a parallel cooling loops, the coolant is pumped by the main circulation pump to the steam generator acting as a heat exchanger. Coolant in the primary circuit of the reactor (deionized water) is flowing through the steam heating pipe of steam generator and transfers heat to the water of the secondary circuit and in result evaporates. The pressurizer is responsible for the alignment of the coolant volume changes and maintaining the required pressure which can be disturbed by temperature changes occurring because of power fluctuations. Using electric heaters, a pressure airbag is produced to compensate coolant volume changes and prevents coolant from boiling. Figure 1 shows primary circuit and its main elements: reactor, main circulation pump, steam generator and pressurizer. Pressurizer is a vertical cylindrical pressure vessel which is built with welded ferritic stainless steel rings and bowls on the top and bottom of the vessel. Internal constructions of the pressurizer are made of stainless steel. At the bottom of the tank are electric heaters and piping connections linking pressurizer with the primary circuit (at the top of tank are: dump valve, security valve, venting valve and injection nozzles). The lower part of the pressurizer is filled with water and the upper section is filled by saturated steam - about 40% of vessel volume.

2. Survey of related works

In nuclear power plants with PWR and Russian VVER (rus.Vodo-Vodyanoi Energetichesky Reactor - water-water energetic reactor) pressurized water reactor P, PI, or PID controllers are a commonly used solution in the water level control system for pressurizer.

Current research on water level control systems for pressurizer focuses on solutions based on PID controller, such as fuzzy PID controller or PID controller using neural networks. In [1] propose the use of fuzzy logic to tune the PI controller, while in [4] expands control system with fuzzy PID controller responsive in transient state.

The use of neural networks is presented in [2], where control system of water level in the pressurizer extended with CMAC (Cerebellar Model Articulation Controller) neural controller, which is used to analyze the dynamics of fuzzy controller as well as "lookup table" instead of numerical calculations. Another application of neural networks is to use them to tune the PID controller, as shown in the [3], it leads to the improvement of the quality of control and resistance to interference. All of these solutions share a common feature- PID algorithm. They differ in approach to synthesis or in tuning of the PID controller.

3. Problem statement and main contribution

The increasing requirements for operation of nuclear power plants in efficiency, quality, cost and safety lead to the need to improve or redesign existing solutions in nuclear power plants. All solutions proposed in literature for the water level control system for pressurizer are based on the modernization of the existing system based on standard PID controller. In the paper a water level control system for a pressurizer is designed from scratch, and the common PID controller will be replaced by control algorithm which consist of: state feedback integral controller (SFIC) and reduced-order Luenberger state observer. The proposed control algorithm allows designing the dynamics of the system output by the method of allocation of the poles of the considered system. The control algorithm is designed to improve the stability of the system and quality control, understood as the reduction of overshoot and settling time compared to existing solutions based on the standard PID controller.

The main contributions of paper are: implementation of the pressurizer water level dynamics model in Matlab/Simulink environment, design and implementation of the state feedback integral controller with reduced-order Luenberger state observer for water level model, validation of designed control algorithm by simulation.

In the paper, in order to design the control system, a nonlinear mathematical model describing the dynamics of the water level in the pressurizer [5] was used for simulation purposes. Implementation of the mathematical model mentioned above and its linearization for synthesis of the control system and state observer has been made in the simulation environment Matlab/Simulink. Based on the linearized model pressurizer



control system was designed and state feedback control with integral action and state observer were implemented. In order to design and implement a state feedback controller, it is necessary to have individual states values available. Since all of these values are not available for measurement, it is necessary to estimate them for the use of the control system. For this purpose, the reduced-order Luenberger observer, which on the basis of the inputs and outputs calculates the pressurizer states, was developed. The main disturbance in this system is the change in coolant leakage flow. Validation of solutions proposed in the paper was made by means of simulations and the performance of the SFIC and PID controller was compared.

4. Water level control system

The control of water level in the pressurizer acts as a loss of water compensator in the primary circuit by maintaining a steady water level in the pressurizer. The water level in the pressurizer is subject to change depending on the state of nuclear power plant operation such as filling, warming up, cooling down, change in the concentration of boric acid in the primary circuit or leaks of main circulation pumps either primary circuit pipelines. Disturbance of water balance in the primary circuit is caused by an increase or loss of coolant. Changes in water levels also depend on the type of the main circulation pumps in the cooling loops and changes in coolant temperature caused by heat released by the reactor.

Prerequisite for the safe and stable operation of the primary circuit is to maintain the water level in the pressurizer at a preset level. Too high water level may affect the functionality of the pressurizer by flooding nozzles or injection valves located inside the tank and disrupt the control system pressure. Low levels of water may lead to the emergence of electric heaters, which should be kept completely immersed in water, causing them damage. The control value of the system is the mass flow of inlet water from additional water supply system. The controller on the basis of average water level and temperature error in the primary circuit acts on the incoming flow of inlet water. Scheme of proposed pressurizer water level control system is illustrated in Fig. 2.

Symbols used in Fig 2. denote:

- l_{PR} is pressurizer's water level,
- l_{PR}^{ref} is pressurizer's water level reference value,
- m_{in} and m_{out} are inlet mass flow rate and purge mass flow rate,
- \hat{M}_{PC} is the estimated by state observer total mass of water in the primary circuit,
- T_I is the temperature of the inlet water,
- T_{PC} is the average temperature of the primary coolant.

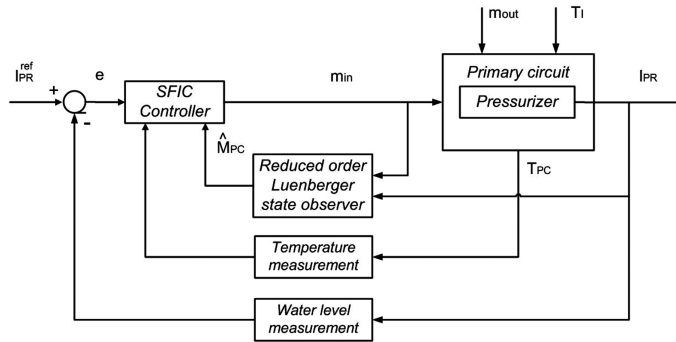

Figure 2. Pressurizer water level control system.

5. Problem solution

Mathematical models of water level in the pressurizer available in the literature are linear input-output transfer function models [2, 3, 4] or complex models that provide a full description of the dynamics of the phenomena occurring in the pressurizer available in dynamic simulators such as Star-90 Simulation Platform [6] or APROS[7]. In the paper a non-linear dynamic model of the water level in the pressurizer, derived from a general model that describes the dynamics of the primary circuit [5], was used. In order to synthesis of the state-feedback integral control system with reduced-order Luenberger observer, nonlinear model of plant was linearized in the operating point. Linearized model was used for calculations of the controller and observer matrices, while the nonlinear one was used for control system verification.

5.1. Modeling

Considered in the paper pressurizer model consists of the total mass balance of water in the primary circuit and the energy balance (energy conservation) contained in the coolant [5]. Coolant is assumed to be in liquid phase and to be pure water - the quantity of boron is negligible. The coolant water in the pressurizer is assumed to be part of the coolant in the primary circuit and is treated as an surplus to a nominal mass of water in primary circuit. The mass of vapor in pressurizer is assumed to be negligible in comparison to mass of water. Dependence on the temperature and pressure of the specific heat of the water is neglected and treated as a constant value. The principle of conservation of mass is described by a differential equation:

$$\frac{dM_{PC}(t)}{dt} = m_{in}(t) - m_{out}(t) \quad (1)$$

where:

- $M_{PC}(t)$ is the total mass of water in the primary circuit,
- $m_{in}(t)$ and $m_{out}(t)$ are inlet mass flow rate and purge mass flow rate.



The overall energy balance is made up by the energy generated in the reactor per time unit, the energy transported to the secondary circuit by six steam generators, the energy changes related to the mass flow and the water loss and energy loss to the surroundings. In general balance of the energy the heat generated in the pressurizer for pressure control in the circuit is omitted. Specific heat of water was taken as a fixed value, except for the temperature dependence. The difference in temperature between the "hot branch" and "cold branch" in the primary circuit piping was taken as a constant value of 30°C [5]. The principle of conservation of energy is described by the differential equation is as follows

$$\frac{dT_{PC}(t)}{dt} = \frac{1}{c_{p,PC}M_{PC}(t)} [c_{p,PC}m_{in}(t)(T_I(t) - T_{PC}(t)) + 15(c_{p,PC}m_{out}(t)) + W_R - 6K_{T,SG}(T_{PC}(t) - T_{SG}(t)) - W_{loss,PC}] \quad (2)$$

where:

- $T_{PC}(t)$ is the average temperature of the primary coolant,
- $c_{p,PC}$ is the specific heat of water,
- $T_I(t)$ is the temperature of the inlet water,
- W_R is the power of the reactor,
- $K_{T,SG}$ is the heat transfer coefficient between the primary and secondary circuit,
- $T_{SG}(t)$ is the temperature of the water in the steam generator,
- $W_{loss,PC}$ is the heat loss to the environment.

The water level in the pressurizer is the model output. Effect of changes in mass and temperature in the primary circuit the water level in the pressurizer, is given by:

$$l_{PR} = \frac{1}{A_{PR}} \left(\frac{M_{PC}}{\varphi(T_{PC})} - V_{PC}^0 \right) \quad (3)$$

where:

- l_{PR} is pressurizer's water level,
- A_{PR} is the pressurizer's cross-section,
- $\varphi(T_{PC})$ is the function of the density of water,
- V_{PC}^0 is the nominal volume of coolant in the primary circuit.



Table 13. Model parameters [5]

Symbol	Description	Units	Value
A_{PR}	vessel cross section	m^2	4.52
$c_{\phi,0}$	water density function coefficient	kg/m^3	581.2
$c_{\phi,1}$	water density function coefficient	$kg/m^3/K$	2.98
$c_{\phi,2}$	water density function coefficient	$kg/m^3/K^2$	-0.00848
$c_{p,PC}$	specific heat (on 282 ⁰ C)	J/kg/K	5355
$K_{T,ST}$	heat transfer coefficient	J/K/s	$9.5296 \cdot 10^6$
T_{ST}	steam generator temperature	⁰ C	257.78
V_{PC}^0	water nominal volume	m^3	242
$W_{loss,PC}$	heat loss	J/s	$1.6823 \cdot 10^5$
W_R	reactor power	W	$13.75 \cdot 10^8$

The density of water is described as the temperature dependence of density with second-degree polynomial function of the form:

$$\varphi(T_{PC}) = c_{\phi,2}T_{PC}^2 + c_{\phi,1}T_{PC} + c_{\phi,0} \quad (4)$$

where $c_{\phi,i}$, $i = 0, 1, 2$ are the coefficients of polynomial functions. Tab. 1 shows the parameters of the pressurizer. They were estimated by Nelder-Mead simplex method using measurement data.

Tab. 2 shows the variables of the model, the values and the nature of the measured data [5].

Obtained on the basis of equations (1)-(3), second order dynamic nonlinear model is in the form:

$$\begin{aligned} \dot{\mathbf{x}} &= f(\mathbf{x}, \mathbf{u}, \mathbf{v}, t) \\ \mathbf{y} &= g(\mathbf{x}, \mathbf{u}, \mathbf{v}, t) \end{aligned} \quad (5)$$

where

- $\dot{\mathbf{x}} = f(\mathbf{x}, \mathbf{u}, \mathbf{v}, t)$ and $\mathbf{y} = g(\mathbf{x}, \mathbf{u}, \mathbf{v}, t)$ are the vectors of nonlinear functions,
- $\mathbf{x}(t)$ is the vector of the state variables $[M_{PC} \ T_{PC}]$,
- $\mathbf{u}(t)$ is the input vector $[m_{in}]$,
- $\mathbf{v}(t)$ is the disturbances vector $[m_{out} \ T_I]$,
- $\mathbf{y}(t)$ is the output vector $[l_{PR}]$.



Table 14. Model variables [5]

Symbol	Description	Units	Value	Type
l_{PR}	water level	m	4.8	output
$M_{PC}(t)$	water mass	kg	200000	state
$m_{in}(t)$	inlet mass flow rate	kg/s	1.4222	input
$m_{out}(t)$	purge mass flow rate	kg/s	2.11	disturbance
$T_i(t)$	inlet water temperature	$^{\circ}\text{C}$	258.85	disturbance
$T_{PC}(t)$	water temperature	$^{\circ}\text{C}$	281.13	state

For the purposes of designing the control system, there is a need for linear model of the form:

$$\begin{aligned}\dot{\mathbf{x}} &= \mathbf{A}\mathbf{x}(t) + \mathbf{B}\mathbf{u}(t) + \mathbf{E}\mathbf{v}(t) \\ \mathbf{y} &= \mathbf{C}\mathbf{x}(t) + \mathbf{D}\mathbf{u}(t)\end{aligned}\quad (6)$$

where \mathbf{A} is a state matrix, \mathbf{B} is the input matrix, \mathbf{C} is the output matrix, \mathbf{D} is the feedforward matrix (\mathbf{D} is the zero matrix) and \mathbf{E} is the disturbances matrix.

In order to linearize nonlinear water level dynamics of pressurizer, Taylor series expansion of functions around equilibrium point was calculated. The equilibrium point is of the form:

$$\dot{\mathbf{x}}_{eq} = f(\mathbf{x}_{eq}, \mathbf{u}_{eq}, \mathbf{v}_{eq}, t) \quad (7)$$

where $\mathbf{x}_{eq} = [M_{PC,eq} T_{PC,eq}]^T$, $\mathbf{u}_{eq} = [m_{in,eq}]$, $\mathbf{v}_{eq} = [m_{out,eq} T_{i,eq}]^T$. The small differences for the state, input and disturbances vector are:

$$\begin{aligned}\Delta \mathbf{x} &= \mathbf{x} - \mathbf{x}_{eq} \\ \Delta \mathbf{u} &= \mathbf{u} - \mathbf{u}_{eq} \\ \Delta \mathbf{v} &= \mathbf{v} - \mathbf{v}_{eq}\end{aligned}\quad (8)$$

with the assumption that:

$$\Delta \dot{\mathbf{x}} = \mathbf{x} - \mathbf{x}_{eq} = f(\mathbf{x}_{eq}, \mathbf{u}_{eq}, \mathbf{v}_{eq}, t) \quad (9)$$

By expanding in Taylor series the right hand side of equations (5) and by neglecting the high order terms, linear equations was obtained in the form:

$$\begin{aligned}\Delta \dot{\mathbf{x}} &= \mathbf{A}\Delta \mathbf{x}(t) + \mathbf{B}\Delta \mathbf{u}(t) + \mathbf{E}\Delta \mathbf{v}(t) \\ \mathbf{y} &= \mathbf{C}\mathbf{x}(t) + \mathbf{D}\Delta \mathbf{u}(t)\end{aligned}\quad (10)$$



where matrices are:

$$\mathbf{A} = \left. \frac{df}{dx} \right|_{\substack{x_{eq} \\ u_{eq} \\ v_{eq}}}, \quad \mathbf{B} = \left. \frac{df}{du} \right|_{\substack{x_{eq} \\ u_{eq} \\ v_{eq}}}, \quad \mathbf{E} = \left. \frac{df}{dv} \right|_{\substack{x_{eq} \\ u_{eq} \\ v_{eq}}}, \quad \mathbf{C} = \left. \frac{dg}{dx} \right|_{\substack{x_{eq} \\ u_{eq} \\ v_{eq}}}, \quad (11)$$

Finally, linear state-space model of the water level dynamics of pressurizer is of the form:

$$\begin{aligned} \dot{\mathbf{x}}(t) = & \left[\begin{array}{cc} 0 & 0 \\ \frac{\left[\begin{array}{c} W_R - W_{loss,PC} + 6K_{T,SG}(T_{SG} - T_{PC,eq}) + \\ 15c_{p,PC}m_{out,eq} + c_{p,PC}m_{in,eq}(T_{I,eq} - T_{PC,eq}) \end{array} \right]}{c_{p,PC}M_{PC,eq}^2} & - \frac{\left[\begin{array}{c} 6K_{T,SG} + \\ c_{p,PC}m_{in,eq} \end{array} \right]}{c_{p,PC}M_{PC,eq}} \end{array} \right] \mathbf{x}(t) \\ & + \left[\begin{array}{c} 1 \\ \frac{[T_{I,eq} - T_{PC,eq}]}{M_{PC,eq}} \end{array} \right] \mathbf{u}(t) + \left[\begin{array}{cc} -1 & 0 \\ \frac{15}{M_{PC,eq}} & \frac{m_{in,eq}}{M_{PC,eq}} \end{array} \right] \mathbf{v}(t) \quad (12) \\ \mathbf{y}(t) = & \left[\begin{array}{cc} 1 & - \frac{[M_{PC,eq}(c_{p1} + 2c_{p2}T_{PC,eq})]}{A_{PR}(c_{p2}T_{PC,eq}^2 + c_{p1}T_{PC,eq} + c_{p0})} \\ \frac{1}{A_{PR}(c_{p2}T_{PC,eq}^2 + c_{p1}T_{PC,eq} + c_{p0})} & - \frac{[M_{PC,eq}(c_{p1} + 2c_{p2}T_{PC,eq})]}{A_{PR}(c_{p2}T_{PC,eq}^2 + c_{p1}T_{PC,eq} + c_{p0})^2} \end{array} \right] \mathbf{x}(t) \end{aligned}$$

Control objective and its variables was presented in section 4 and above. Control with integral action extends the system of integrator in the control loop, which should eliminate the steady state error. Integrator extends the vector of state variables of an integrator state variable \mathbf{x}_I . It is integral of error of realizing the setpoint by the output (equation (13)). The system is closed by a negative feedback loop (matrix \mathbf{L}_1) and the feedback from the state (matrix \mathbf{L}_2). The matrix \mathbf{L} , ($\mathbf{L} = [\mathbf{L}_1 \ \mathbf{L}_2]$) is responsible for allocating the desired poles of a closed system [8]. The pole placement method allows to shaping the dynamics of the system and the parameters the system response (overshoot and settling time).

$$\dot{\mathbf{x}}_I(t) = \mathbf{y}_r(t) - \mathbf{y}(t) = \mathbf{y}_r(t) - \mathbf{C}\mathbf{x}(t) \quad (13)$$

where \mathbf{x}_I – integrator state and \mathbf{y}_r – setpoint.

After closing the system by the control law (equation (14)), a full description of the system is given by the equations (15).

$$\mathbf{u} = -\mathbf{L}_1\mathbf{x} - \mathbf{L}_2\mathbf{x}_I = -[\mathbf{L}_1 \ \mathbf{L}_2] \begin{bmatrix} \mathbf{x} \\ \mathbf{x}_I \end{bmatrix} \quad (14)$$



$$\begin{bmatrix} \dot{\mathbf{x}} \\ \dot{\mathbf{x}}_I \end{bmatrix} = \begin{bmatrix} \mathbf{A} - \mathbf{B}\mathbf{L}_1 & -\mathbf{B}\mathbf{L}_2 \\ -\mathbf{C} & \mathbf{0} \end{bmatrix} \begin{bmatrix} \mathbf{x} \\ \mathbf{x}_I \end{bmatrix} + \begin{bmatrix} \mathbf{0} \\ \mathbf{I} \end{bmatrix} \mathbf{y}_r \quad (15)$$

$$\mathbf{y} = [\mathbf{C} \ \mathbf{0}] \begin{bmatrix} \mathbf{x} \\ \mathbf{x}_I \end{bmatrix}$$

where \mathbf{I} is the identity matrix.

Matrices \mathbf{L}_1 and \mathbf{L}_2 determined by Ackermann's formula [8], and the necessary condition is the controllability of the system. Ackermann's formula can be written as:

$$\mathbf{L} = [0 \ 0 \ \dots \ 0 \ 1] \mathbf{Q}_{ctrl}^{-1} p(\mathbf{A}) \quad (16)$$

and

$$\mathbf{Q}_{ctrl} = [\mathbf{B} \ \mathbf{A}\mathbf{B} \ \mathbf{A}\mathbf{B}^2 \ \dots \ \mathbf{A}\mathbf{B}^n] \quad (17)$$

$$p(\mathbf{A}) = \mathbf{A}^n + \alpha_1 \mathbf{A}^{n-1} + \alpha_2 \mathbf{A}^{n-2} + \dots + \alpha_{n-1} \mathbf{A} + \alpha_n \mathbf{I} \quad (18)$$

where:

- \mathbf{Q}_{ctrl} is the controllability matrix,
- $p(\mathbf{A})$ is the characteristic polynomial of the matrix \mathbf{A} ,
- α_n - coefficients of the characteristic polynomial,
- n - system order.

The lack of full state vector measurement, leads to a need for reconstruction of unmeasurable state, which could be reconstructed from measurement of input $\mathbf{u}(t)$ and output $\mathbf{y}(t)$. In the paper the reduced-order Lunberger state observer was used. Using knowledge about the system parameters (\mathbf{A} , \mathbf{B} , \mathbf{C} , \mathbf{D}), measurements $\mathbf{u}(t)$ and output $\mathbf{y}(t)$, it is possible to obtain the estimated value of state vector $\hat{\mathbf{x}}(t)$. The observer is based on linear model of the plant and is given by:

$$\begin{aligned} \dot{\hat{\mathbf{x}}} &= \mathbf{A}\hat{\mathbf{x}}(t) + \mathbf{B}\mathbf{u}(t) + \mathbf{G}\mathbf{C}\tilde{\mathbf{x}}(t) \\ \hat{\mathbf{y}} &= \mathbf{C}\hat{\mathbf{x}}(t) \end{aligned} \quad (19)$$

where $\tilde{\mathbf{x}}(t) = \mathbf{x}(t) - \hat{\mathbf{x}}(t)$ is the estimation error, \mathbf{G} is matrix of the observer gains. Matrix \mathbf{G} is determined by Ackermann's formula [8]:

$$\mathbf{G} = [0 \ 0 \ \dots \ 0 \ 1] \mathbf{Q}_{obsv}^{-1} p(\mathbf{A}) \quad (20)$$

and

$$\mathbf{Q}_{obsv} = [\mathbf{C} \ \mathbf{C}\mathbf{A} \ \mathbf{C}\mathbf{A}^2 \ \dots \ \mathbf{C}\mathbf{A}^n]^T \quad (21)$$

where \mathbf{Q}_{obsv} is the observability matrix.

The structure of the proposed control system with reduced-order state observer and state feedback integral controller on the overall control algorithm synthesis stage is shown in Fig. 3.



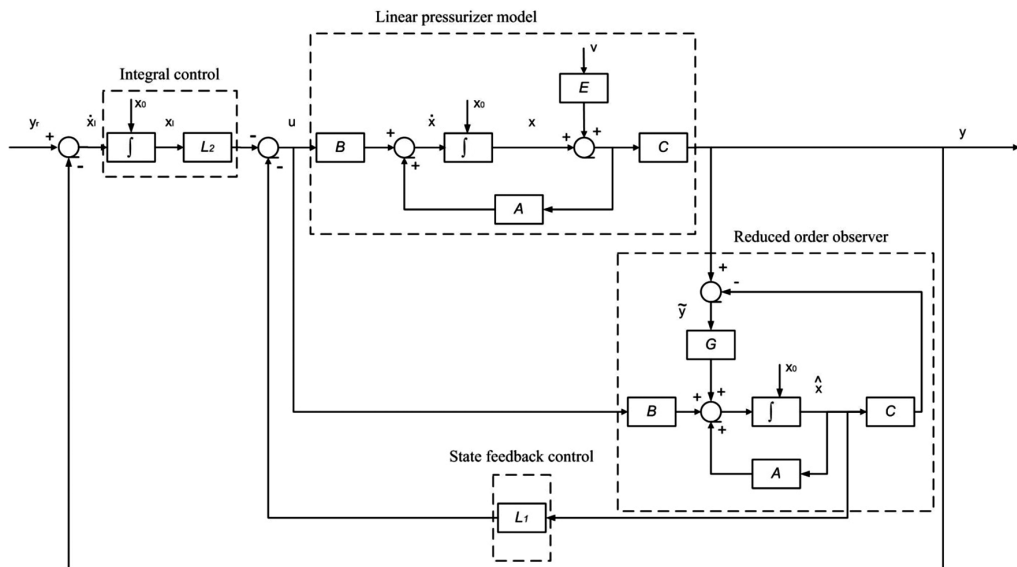

Figure 3. Water level control system with state feedback with integral action and observer.

5.2. Implementation

The plant dynamics, nonlinear model, reduced-order Luenberger observer and control systems were implemented in the Matlab/Simulink R2011a software. In order to compare designed SFIC controller with state observer to sample PID controller, poles of SFIC controller were located in the same place as PID controller. On the basis of the PID parameters (Tab. 3) the poles of the system were calculated. Basing on them, the SFIC controller was synthesized for comparison with PID. Reduced-order observer gain values were chosen in such a way to make observer 20 times faster than the plant and so that it was possible to correct the discrepancies caused by non-linearity of the model. Tab. 3 includes gains of controllers and observer, which were used during the validation of the proposed solution.

5.2.1. State observer

A reduced-state Luenberger observer was implemented to estimate the plant. For the purpose of control system estimation of only one state is needed (coolant level) as the coolant temperature is directly measured and available. The nonlinearity is partly caused by a constant bias added to the output so a constant value ("Shift") was added to shift the observers output. Fig. 4 shows the output of the observer and the simulated pressurizer.

Fig. 4 shows that the Luenberger observer is able to follow the coolant level with acceptable accuracy despite the nonlinearity and the sensor noise (normally distributed noise with a flat power spectral density equal to 0.0000001W/Hz and sample time 0.1s).

Table 15. Controllers and observer gains

Symbol	Description	Value
SFIC controller		
K1	Gain for the first state of the plant	0.0589
K2	Gain for the second state of the plant	59.1151
K3	Gain for the third state of the plant	9.2655
State Observer		
L1	State correction gain for the first state	$1.3735 \cdot 10^3$
L2	State correction gain for the second state	4.6
PID controller		
K1p	Proportional gain	200
K1i	Integral gain	10
K1d	Derivative gain	1

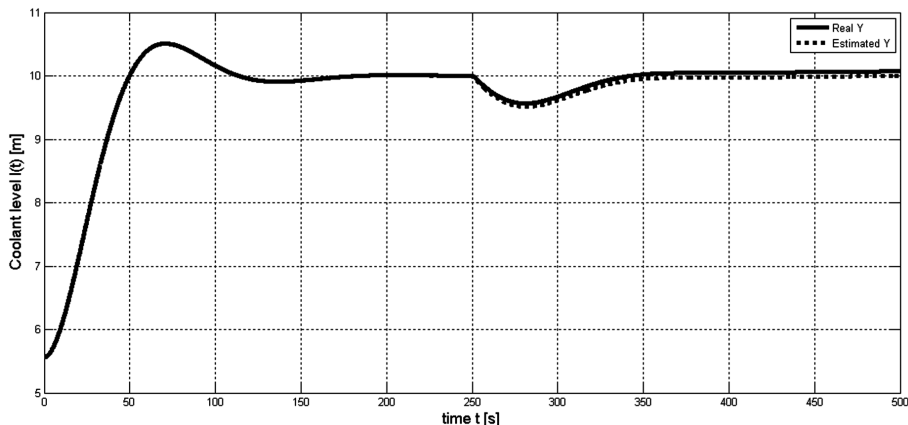

Figure 4. Real and estimated by Luenberger observer value of coolant level.

5.2.2. State feedback control with integral action

A state feedback controller with integral action SFIC was implemented. As it was stated in a previous section only one state was estimated with reduced-order Luenberger observer, because the coolant temperature measurement is available for the control purposes. After control system synthesis a white noise was added to the system output to simulate the measurement uncertainty. Both systems (with PID and SFIC controller) were modeled in Matlab/Simulink environment. Following transfer functions were ob-



tained (neglecting observer's dynamic to achieve models of the same order assuming that observer only extends the system with two additional poles). SFIC (without the state observer):

$$F(s)_{SFIC} = \frac{l_{PR}}{l_{PRref}} = \frac{-1.388 \cdot 10^{-17} \cdot s^2 + 0.002604 \cdot s + 0.000144}{s^3 + 0.1047 \cdot s^2 + 0.005682 \cdot s + 0.000144} \quad (22)$$

PID:

$$F(s)_{PID} = \frac{l_{PR}}{l_{PRref}} = \frac{0.05617 \cdot s^2 + 0.005735 \cdot s + 0.0001463}{s^3 + 0.1057 \cdot s^2 + 0.005735 \cdot s + 0.0001463} \quad (23)$$

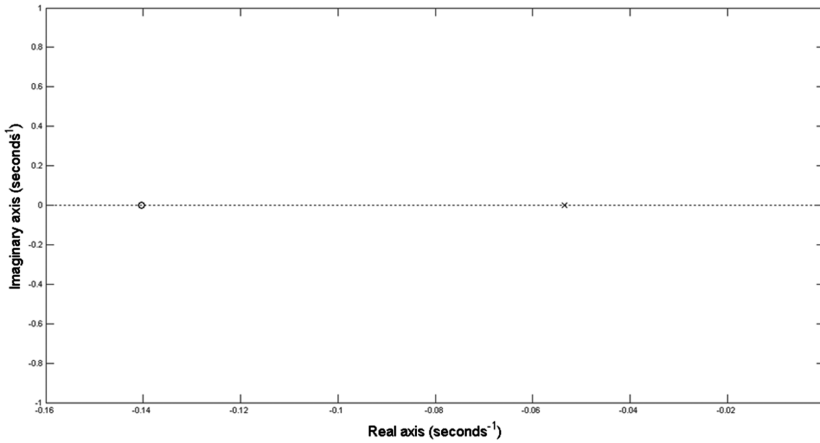

Figure 5. Plant pole-zero map.

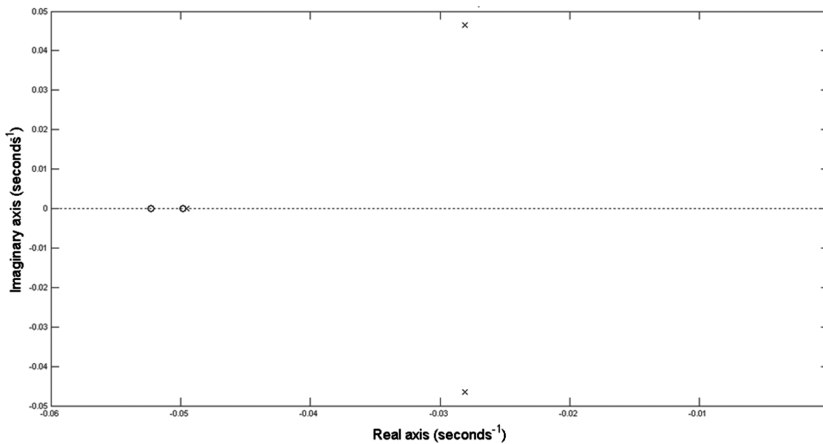

Figure 6. System with PID controller pole-zero map.

Fig. 5 shows the pole-zero map of the plant with its two poles and one zero, while Fig. 6 shows zeros and poles obtained after using the PID controller (additional pole is related to the integral part of the controller).

Basing on the poles locations of the system with PID controller a SFIC controller was synthesized using the Ackerman method. The poles of the plant and system with the controllers were as follows:

- plant poles: 0; - 0.0534
- poles of the system with SFIC controller: - 0.0280 + 0.0466i; - 0.0280 - 0.0466i; - 0.0487
- poles of the system with PID controller: - 0.0281 + 0.0465i; - 0.0281 - 0.0465i; - 0.0495.

The poles of the systems with PID and SFIC controllers were placed in almost the same location. Systems with two different controllers with the same poles locations were used for controller comparison

5.3. Validation

In order to validate the operation of developed SFIC controller, a comparison of system responses using the two controller types (PID and SFIC) to the step input (analysis of overshoot, settling time) was made and system reaction to introduced disturbance of the coolant leakage (loss of coolant at 250s) was examined. Three controllers were analyzed: a PID and SFIC controllers with the same poles and a PID controller with the same overshoot as the SFIC controller. As the disturbance a huge loss of coolant at 250s was chosen. It can be interpreted as an occurrence of a crack in a primary circuit pipeline. The course of the coolant loss is shown in Fig. 7. Before the 250 s the coolant loss is on a level of 2.11 kg/s and is related to the normal plant operation.

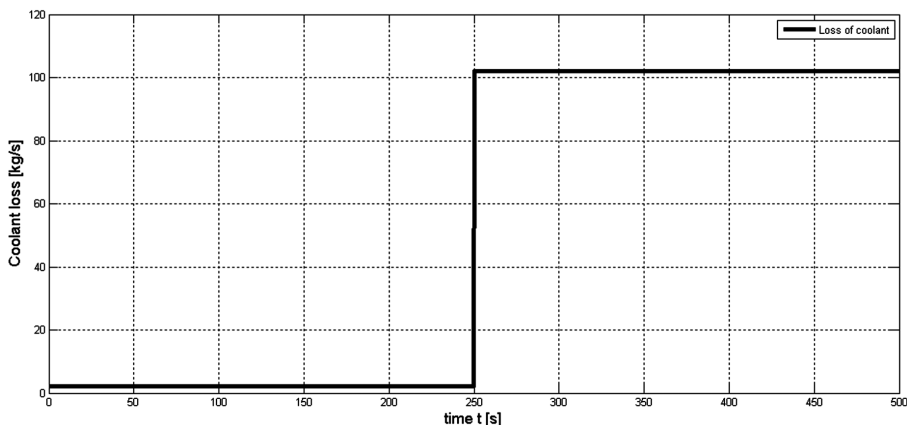

Figure 7. Disturbance - loss of coolant at 250s.

Fig. 8 shows the comparison of step response from a sample water level 5.5 m to 10 meters (to 200th second) and the response to the disturbance (from 250th second).

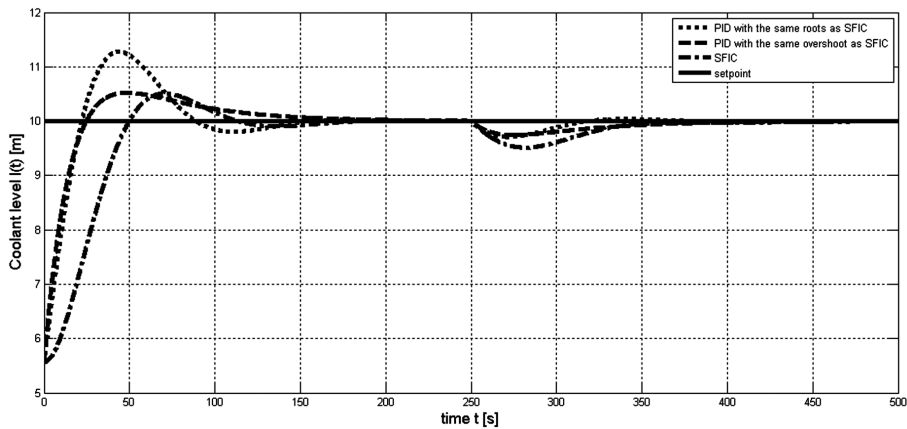

Figure 8. Comparison of PID and SFIC with the same poles controllers and PID with the same overshoot as SFIC - step response and disturbance at 250s.

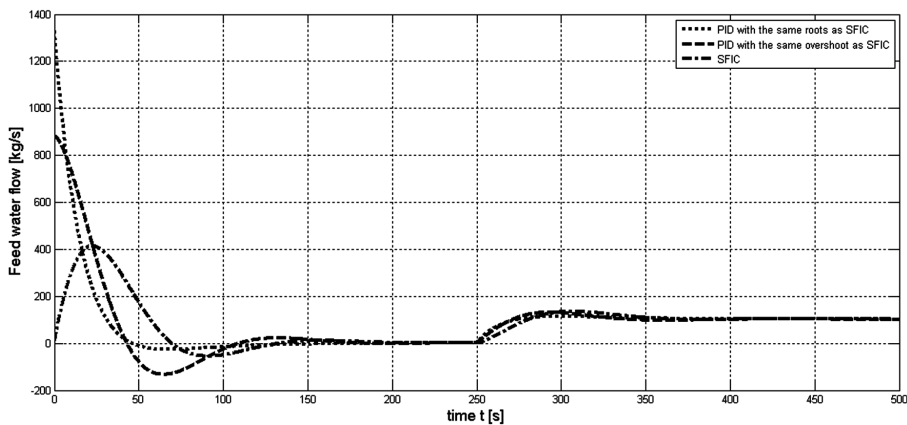

Figure 9. Comparison of PID and SFIC with the same poles controllers and PID with the same overshoot as SFIC - system input.

Fig. 9 shows system inputs for all three cases.

The signal for the SFIC controller is about two to three times smaller than the input of the system with PID controller. The controllers with similar poles had different zeros what influenced the shape of the response. Even though it is possible to tune PID controller in this case to have similar overshoot as SFIC the example was chosen to show that even with the same poles the output may be different due to the differences between the controllers and different zeros.

6. Conclusions

There are main two types of nuclear power plant operation. Starting, when a swift and significant change in the operating parameters occurs, and stable operation, where the only goal of the pressurizer control system is compensation of disturbances. In the paper only the operation of a power plant is considered.

As shown in the paper it is possible to design a state feedback controller with integral action and state observer for the purpose of water level control in a nuclear plant pressurizer. Even if the control quality of a SFIC controller is not better than the quality for a PID (smaller overshoot but longer rising time) it shows that the other approach to the problem can be also successful. This can be a base for the further research on the subject of SFIC use in the nuclear power plant control systems. The next step should be the integration of the pressure and the water level SFIC controllers into one, complex, MIMO pressurizer controller.

A further works should also be to check the work of the SFIC control system in a professional environment dedicated to the simulation of nuclear power plants such as APROS or Flownex, which use more complex models of a pressurizer. Sensitivity to controller and observer parameters changes and state estimation errors analysis is also very important and interesting. Currently used controllers are supervised by a supervisory control layer. Verification of the SFIC with advanced algorithms used in the supervisory control layer operation is required.

References

- [1] J. GUO, X. SUN and H. WU: Research of pressurizer water level control system based on fuzzy-PID control. *Proc. of the 4th Int. Workshop on Advanced Computational Intelligence (IWACI)*, Wuhan, China, (2011), 706-709.
- [2] J YI, J. YE, Z. XUE, X. YANG and X. QIAN: Research on pressurizer water level control of nuclear reactor based on CMAC and PID Controller. *Proc. of the Int. Conf. on Artificial Intelligence and Computational Intelligence (AICI '09)*, Shanghai, China, (2009), 8-11.
- [3] J.H. YE, J.M. YI, H.Y. JI: Research on pressurizer water level control of nuclear reactor based on RBF neural network and PID controller. *Proc. of the Int. Conf. on Machine Learning and Cybernetics (ICMLC)*, Qingdao, China, (2010), 1486-1489.
- [4] G.D. ZHAN, X.H. YAN, X.L. YE, H. XU, D.Q. LU and W. CHEN: Research on pressurizer water level control of pressurized water reactor nuclear power station. *Energy Procedia*, **16**, Part B, (2012), 849-855.

- [5] Cs. FAZEKAS, G. SZEDERKÉNYI and K.M. HANGOS: A simple dynamic model of the primary circuit in VVER plants for controller design purposes. *Nuclear Engineering and Design*, **237** (2007), 1071-1087.
- [6] L. YONGLING, M. JIN, CH. AFANG, H. YU and W. BINGSHU Mechanism model of pressurizer in the pressurized water reactor nuclear power plant based on PSO algorithm. *Proc. of the Control and Decision Conf. (CCDC)*, Taiyuan, China, (2012), 178-182.
- [7] E. TAKASUO: Modeling of Pressurizer Using APROS and TRACE Thermal Hydraulic Codes. VTT Research Notes 2339, Helsinki, Finland, 2006.
- [8] M. CUIBUS, V. BOSTAN, S. AMBROSII, C. ILAS and R. MAGUREANU: Luenberger, Kalman and neural network observers for sensorless induction motor control. *Proc. of the 3rd Int. Conf. on Power Electronics and Motion Control (IPEMC 2000)*, Beijing, China, (2000), 1256-1261.