

SURFACE IRREGULARITIES AS A COMPLEX SIGNAL OF TOOL REPRESENTATION TOGETHER WITH UNEVEN DISPLACEMENT IN RESPECT TO THE WORKPIECE

Adam Boryczko, Wojciech Rytlewski

*Gdańsk University of Technology, Faculty of Mechanical Engineering, G. Narutowicza 11/12, 80-233 Gdańsk, Poland,
(✉ aboryczk@pg.gda.pl, +48 58 347 1478)*

Abstract

In a dynamic machining process, distortion in surface irregularity is a very complex phenomenon. Surface irregularities form a periodic representation of the tool profile with various kinds of disturbance in a broad range of changes in the height and length of the profile. To discern these irregularity disturbances, interactions of the tool in the form of changes perpendicular and parallel relative to the workpiece were analyzed and simulated. The individual kinds of displacement of the tool relative to the workpiece introduce distortions in the changes of height and length. These changes are weakly represented in standard height and length irregularity parameters and their discernment has been found through amplitude-frequency functions.

Keywords: surface irregularities, surface profile, tool profile, surface disturbances, tool displacements.

© 2014 Polish Academy of Sciences. All rights reserved

1. Introduction

In a dynamic machining procedure, any disturbance to surface irregularities is a very complex process. The surface irregularities generated then constitute a periodic projection of the tool profile with multiple kinds of distortion in a broad range of changes in profile height and length. To distinguish between the irregularity disturbances, the interaction between the tool and the workpiece should be analyzed through the tool's relative displacement with respect to the workpiece.

In order to identify the disturbances which influence the formation of surface irregularities, a single-point machining process is assumed characterized by a distinct representation of the tool's edge outline on the workpiece surface. The most commonly found kind of single-point machining is lengthwise turning whose geometrical surface structure (GSS) contains directed irregularities resulting from a projection of the tool's outline and the kinematics of the tool's displacement relative to the workpiece.

In publications [1, 2] radial displacement of the tool in respect to the workpiece perpendicularly to it is analyzed. Publications [3, 4] describe the displacement of the tool parallel with respect to the workpiece.

In an ideal process, the representation of the cutting tool edge on the workpiece's surface is regular and identified with an even "microthread". The theoretical GSS shows a characteristic "helical line" with the pitch equal to the feed value. The transverse GSS contains a regularly repeating tool edge outline with the spacing value equal to that of the feed per workpiece revolution f . The problem of complex interactions of the tool in both directions relative to the

workpiece is a proper analytical approach, as shown in [5, 6]. As the disturbance of irregularities is complex, occurs both in height and length, it should be analyzed by means of spectral functions [7]. A confirmation of the interaction of the tool with the formation of irregularity disturbances can be found in [8, 9, 10]. Papers [11, 12] point out the displacement of the tool against the workpiece, when forming transversal irregularities. Radial displacements of the tool are responsible for the amplitude character of changes in surface irregularities, while displacements tangential to the surface for the character of frequency disturbances [13]. For this reason the problem of complex disturbances of surface irregularities should be analyzed with the use of amplitude-frequency functions in a wide range of irregularity changes [14, 15].

Theoretical irregularity heights Rt in ideal machining conditions and a curved projection of the tool edge are calculated from the equation:

$$Rt = r_{\varepsilon} - \frac{1}{2} \sqrt{4r_{\varepsilon}^2 - f^2} \approx \frac{f^2}{8r_{\varepsilon}}, \quad (1)$$

where: f – is the tool feed per revolution,
 r_{ε} – is the edge nose radius.

The irregularity heights grow with an increase of the feed value and they decrease nonlinearly with an increase of the tool edge nose radius. Their distinct influence on the formation of the transverse profile irregularity is shown in the ranges of greatest feed values and smallest values of the radius of the tool nose curvature.

In practical machining circumstances, disturbances in surface irregularities occur and these are caused by influence of the whole machining system on the GSS formed in the machining process. In a turning process, the representation of the edge profile is disturbed by many physical effects which occur in the tool movement kinematics as well as that of the workpiece (friction, elastic deformations, clearances, vibrations). The heights of irregularities on the surfaces differ from theoretical values to a various extent as a result of the complex character of disturbances in the machining system.

2. Types of tool displacement in respect to the workpiece

The machining system consists of a machine tool (subunits of spindle revolution and tool feed), the cutting tool (T) and workpiece (W) combined in the machining process. Because of this, the reaction upon the surface comes from the individual elements of the system, as depicted in Fig.1. For surface features such as accuracy and quality, very important are disturbances in the form of relative displacements of the tool with respect to the workpiece in the direction “ Δx ” perpendicular to the surface, also called “radial” for the object $(T-W)_x$. Besides, displacements of the tool in respect to the workpiece in the direction parallel to the surface and to the direction of tool feed “ Δz ”, defined as “axial” for the subject $(T-W)_z$. The first of them have a deciding influence on the formation of irregularities transverse to the surface of the workpiece.

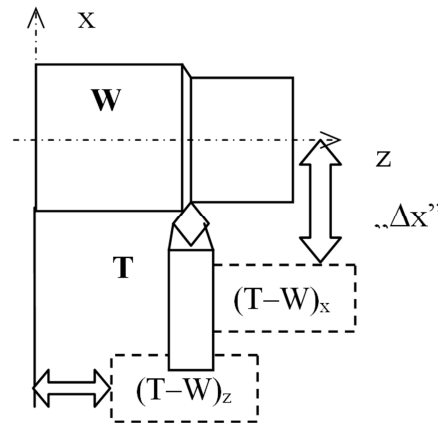

Fig. 1. Tool displacement in respect to the workpiece.

To detect changes in irregularities of the transverse surface profile and the causes of their origin, models of displacement of the curved cutting edge profile in the perpendicular and parallel direction in regard to the workpiece were used.

Fig. 2 shows the transverse irregularity profile in the plane parallel to the basic tool surface, characterized only by dislocations of the mapped edge profile perpendicular to the workpiece “ Δx ” during its successive revolutions. Irregularity heights and its depressions have variable positions, which depend on whether the tool approaches or moves away from the workpiece.

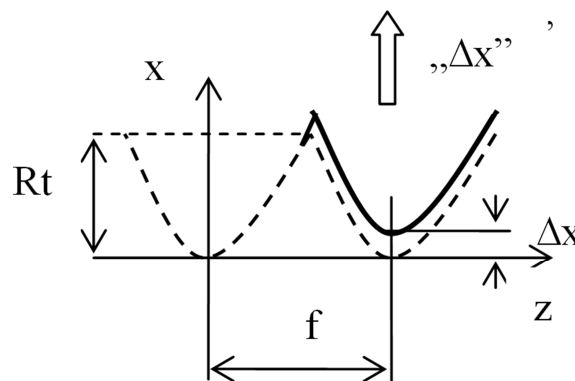

Fig. 2. Transversal irregularities with radial displacement of the tool edge outline perpendicularly to workpiece “ Δx ”.

The analyzed case is a deterioration of surface accuracy in comparison with an ideal irregularity (shown by the broken line) and is expressed through changes of irregularity heights as well as placement of peaks along the profile length. The effect of such disturbance has the character of amplitude and frequency modulation of irregularity heights when compared with an ideal projection of the tool edge.

Another case of disturbance of ideal irregularities by dislocations of edge profile representation in a direction parallel to surface “ Δz ” is shown in Fig. 3. Irregularity depressions have the same height values but their separation is changing in a way characteristic for a variably realized tool feed per workpiece revolution f . The heights of irregularity peaks change their value and position along the profile length. This type

of disturbance produces better surface accuracy effects but has a similar character of amplitude and frequency modulation of the position of height peaks in the surface profile irregularity.

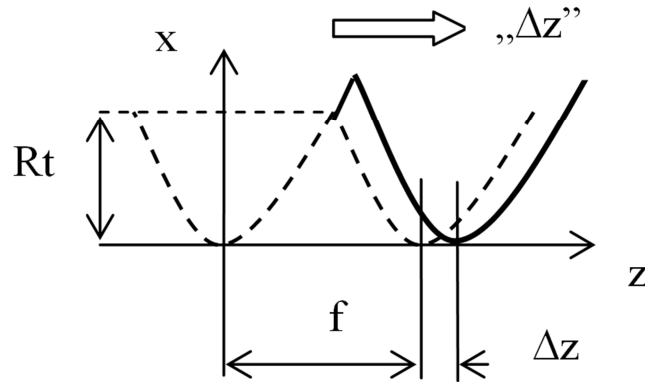

Fig. 3. Transversal irregularities with displacement of the tool edge outline parallel to the workpiece's axis "Δz".

3. Changes in surface irregularity resulting from tool movements in respect to the workpiece

In order to determine the influence of the kind of tool displacement in respect to the workpiece upon the shape of transverse GSS irregularities, a simulation has been conducted and the modulation type of irregularity disturbance with successive revolutions of the workpiece analyzed.

3.1. Modeling of surface irregularities disturbed by perpendicular displacement of the tool against the workpiece

To perform a simulation of the effect of perpendicular displacements of the tool in respect to the workpiece ($T-W$)_x upon the surface irregularities, a model of disturbance according to Fig.2 has been used.

Irregularities of edge profile projection are realized with the value increasing by Δx (shifting the tool from the workpiece) or decreasing (with the tool approaching the workpiece) comparing with the previous position. In mappings with such changes of tool placement as disturbances, the heights of irregularities are modified which depend on the value of the tool displacement with respect to the workpiece.

Simulations were conducted for a curved representation of the tool edge and tool position changes which are shown in Fig. 4 as an example for the range $x = 0 \div 16 \mu m$ and $\Delta x_j = 2 \mu m$ with successive revolutions of the object $j = 1, 2, \dots, M$. Because of symmetry of the disturbances, only the effects of irregularity changes for increasing displacements of the tool against the workpiece are shown. The heights of irregularity peaks explicitly rise, but they shift also horizontally in the direction of the represented edge outline while the tool withdraws itself from the workpiece.

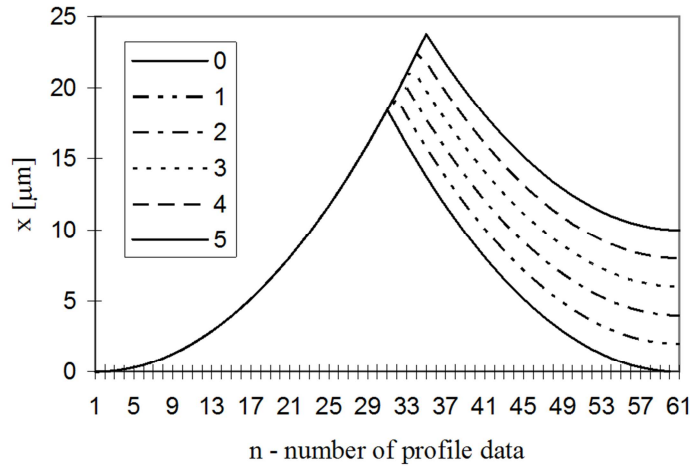

Fig. 4. Simulation results of surface profile irregularities with effects of perpendicular displacements of the tool against the workpiece for succeeding $j = 1, 2, \dots$, movements away of the tool with $\Delta x_j = 2 \mu\text{m}$ with the following parameters: $f = 0.256 \text{ mm/rev}$, $r_e = 0.4 \text{ mm}$, sampling interval $h = 4 \mu\text{m}$.

Changes in the position of the tool distinctly disturb the irregularity heights and such case can be defined as amplitude modulation of the profile irregularity. The peaks shift also in the direction of the realized edge representation together with the simulated disturbance which has the character of frequency modulation.

3.2. Modeling of surface irregularities disturbed by parallel displacement of the tool against the workpiece

For the simulation of the effect of parallel displacements of the tool in relation to the workpiece $(T-W)_z$ on surface irregularities, a disturbance model according to the scheme presented in Fig. 3 was used. The simulation was performed for a curved tool edge representation and for changes of tool feed increasing by a constant value of $\Delta z = 2 \mu\text{m}$ in successive representations per workpiece revolution. The aim is to increase the distance between the curved tool edge projections in direction “z” according to $f_{j+1} = f_j + \Delta z_{j+1}$ for successive revolutions of the workpiece $j = 1, 2, \dots, M$. This is the realization of an unequal value of tool feed $f_j = \text{var}$ for successive object revolutions in relation to a constant feed value per revolution as reference.

Irregularities of tool edge projection are realized for each workpiece revolution increasingly (increase of the tool feed value) and decreasingly (reduction of the tool feed value) in relation to the previous position. Because of the symmetry of disturbances (Fig. 5), only the effects of irregularity changes are shown for increasing displacements of the tool against the workpiece in the feed direction.

When comparing the irregularities which result from the increasing tool feed value, we notice their clear height increase without a change in shape and such character of change indicates amplitude modulation. On the other hand, the discussed type of disturbance in the profile is a typical frequency modulation with varying period represented by the tool feed. In this way, the simulated irregularity has the character of amplitude-frequency changes of irregularity heights with the analyzed disturbances of an uneven realization of tool feed per workpiece revolution.



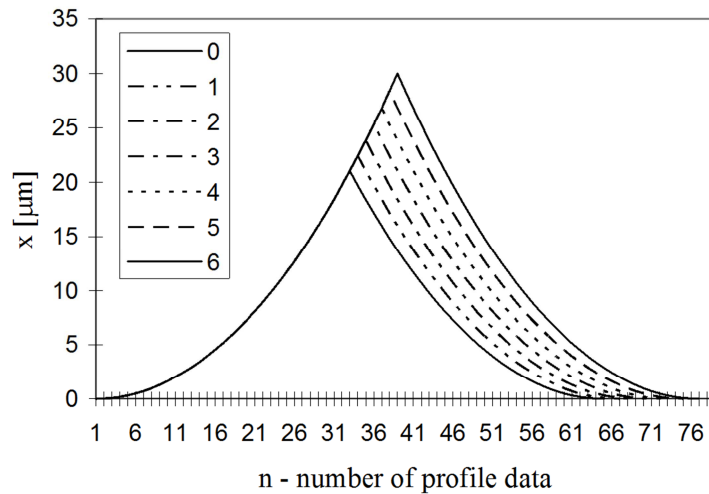

Fig. 5. Simulation results of surface profile irregularities with effect of parallel displacements of the tool against the workpiece for succeeding $j = 1, 2, \dots$ movements of the tool by $\Delta z_j = 2 \mu\text{m}$ with the following parameters: $f = 0.256 \text{ mm/rev}$, $r_\epsilon = 0.4 \text{ mm}$, sampling interval $h = 4 \mu\text{m}$.

The performed process of simulation of the effect of displacements of the tool against the object leads to such observations that the expected effect of amplitude modulation for perpendicular displacements is accompanied also by frequency modulation of the irregularity peaks. Instead, the effect of frequency modulation with effects with varying values of tool feed produces also an amplitude modulation of irregularity peaks.

In real conditions of lathe work both kinds of disturbances appear, perpendicularly (radial) and parallel to the workpiece (axial) and on the surface irregularity such components appear which have a complex amplitude-frequency character. Because of this, for irregularity studies, they should be investigated, discerned, evaluated and estimated spectrally, treating the surface profiles as periodic functions with random-periodic disturbances of the machining process. Also, because of the inaccuracy and ambiguity of characterizing surface irregularities with parameters such as height and length from standards, they should be analyzed and estimated by amplitude-frequency functions in a wide range of irregularities.

4. Recognition of disturbances of tool projection in surface irregularities

For verification, disturbance displacement tool to workpiece was done by measurements surface profiles on profilometer Hommel Tester T1000 with a radius tip of $2 \mu\text{m}$. A test sample was made in 45 steel, machined on a TUD50 lathe. Parameters during turning: feed tool per revolution of the workpiece $f = 0.24 \text{ mm/rev}$. and radius profile of blade $r_\epsilon = 0.4 \text{ mm}$. In measured turned surface profile irregularities, distinct valleys in the disturbed tool edge representation appear which show the tool position at each workpiece revolution. They should be determined in the profile length as local minima (LM) for each tool feed per workpiece revolution, according to the description by coordinates of individual points, as shown in Fig. 6:

$$P_1(z_1, x_1), \dots, P_j(z_j, x_j), P_{j+1}(z_{j+1}, x_{j+1}), \dots, P_{M-1}(z_{M-1}, x_{M-1}). \quad (2)$$

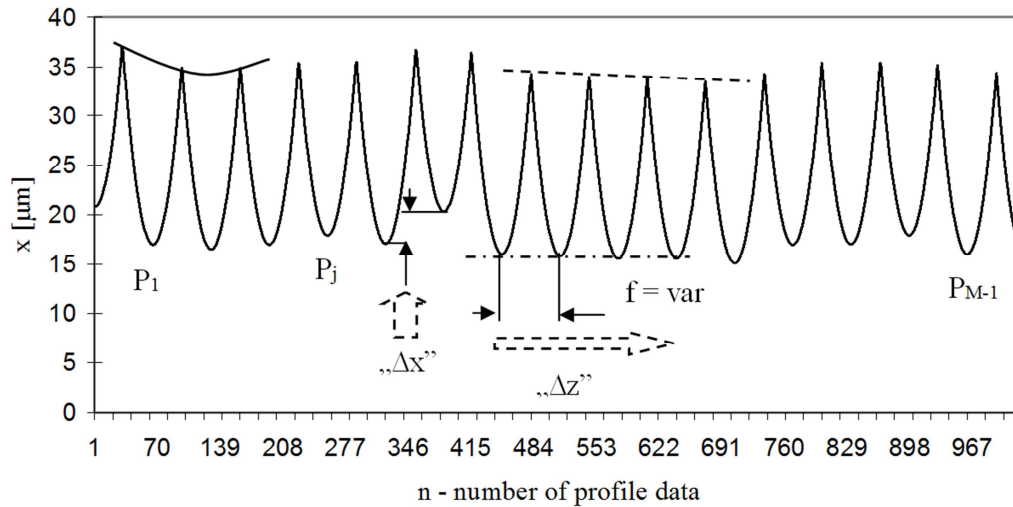

Fig. 6. Measured surface irregularity profile with described local minima in the projection of the tool edge envelope per object revolution $j = 1, 2, \dots, M-1$. Continuous line – irregularity envelope with perpendicular tool displacements against the workpiece. Broken line – irregularity envelope with unequal and parallel displacements of the tool against the workpiece, sampling interval $h = 4 \mu\text{m}$.

As the position of the tool depends on displacements in both directions, “ Δx ” and “ Δz ”, to discern between them we should examine in local minima the appropriate coordinates of points $P_j(z_j, x_j)$ for consecutive revolutions of the object $j = 1, 2, \dots, M$.

From measurement data of the profile we should select the values of successive local minima. For the determination of respective kinds of displacements, define in points P_j the coordinates of proper disturbance directions.

For radial displacements “ x ”, assuming $f_j = \text{const}$, local minima appear in the following profile points:

$$P_1(f, x_1), \dots, P_j(jf, x_j), \dots, P_{j+1}((j+1)f, x_{j+1}), \dots, P_{M-1}((M-1)f, x_{M-1}). \quad (3)$$

After generating their values and combining them we receive the course of tool displacement in relation to the workpiece at each turn $j = 1, 2, \dots, M$ in the direction perpendicular to the surface, as shown in Fig. 7. The values of ordinates depict the character of changes of the tool displacement perpendicularly to the workpiece at each of its turns, with constant tool feed. The position of the tool determined in this way in local minima shows the location of successive valleys in transverse irregularities.

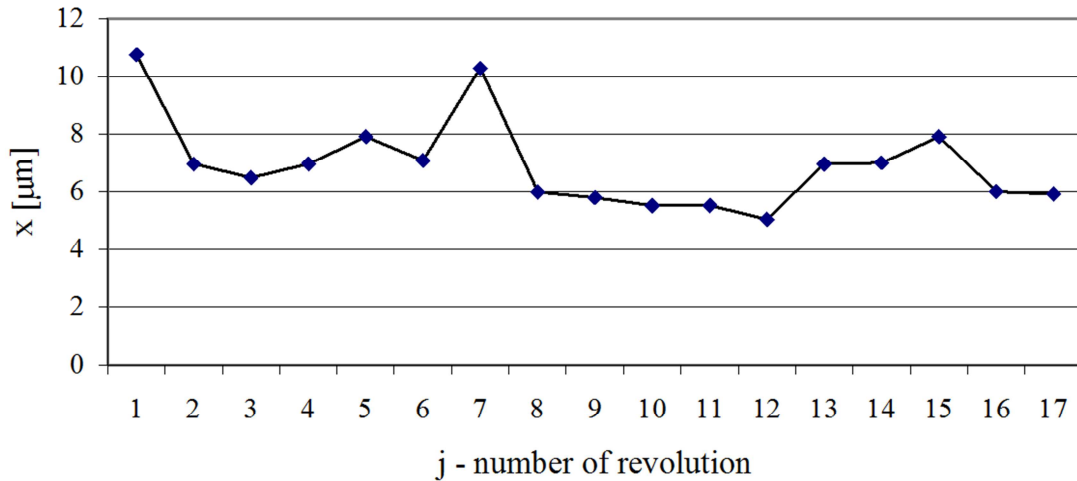

Fig. 7. Tool displacements against the workpiece selected in successive workpiece revolutions $j = 1, 2, \dots$ with radial displacements of the tool to the workpiece.

The generated course of irregularities with curved representation of the tool and disturbances of perpendicular displacements of the tool against the workpiece is presented in Fig. 8.

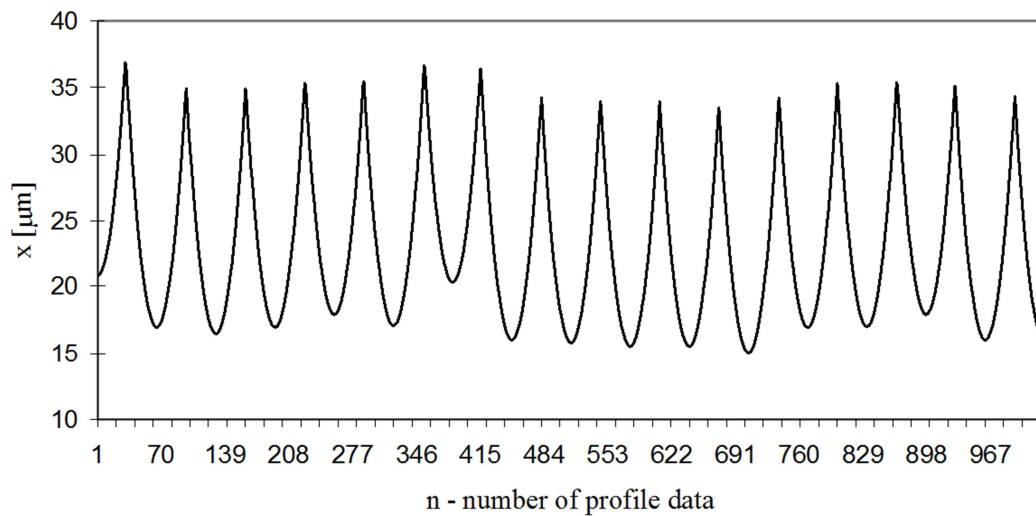

Fig. 8. Generated irregularity course with curved tool profile with disturbances of perpendicular displacements of the tool against the workpiece, sampling interval $h = 4 \mu m$.

We notice a distinct waviness of peaks and valleys in irregularities. These disturbances, as amplitude modulation of the tool projection, have a significant influence on the formation of transverse surface irregularities but are barely discernible in the value of irregularity height parameters. Their investigation has to be carried out with the use of amplitude-frequency functions.

For displacements parallel to the workpiece axis “z”, assuming that radial displacements $\Delta x_j = 0$ do not take place, the local minima appear in profile points:

$$P_1(z_1, 0), \dots, P_j(z_j, 0), P_{j+1}(z_{j+1}, 0), \dots, P_{M-1}(z_{M-1}, 0). \quad (4)$$

Abscissa values in local minima observed in the direction of tool feed and parallel to the workpiece’s surface are less observable because of their smaller differences in successive revolutions. Therefore they should be analyzed relative to the nominal value of the tool feed per workpiece revolution f as differences at every revolution, as shown in Fig. 9. Their relative values assume positive and negative values round the nominal feed value, what shows the uneven tool feed at each workpiece revolution.

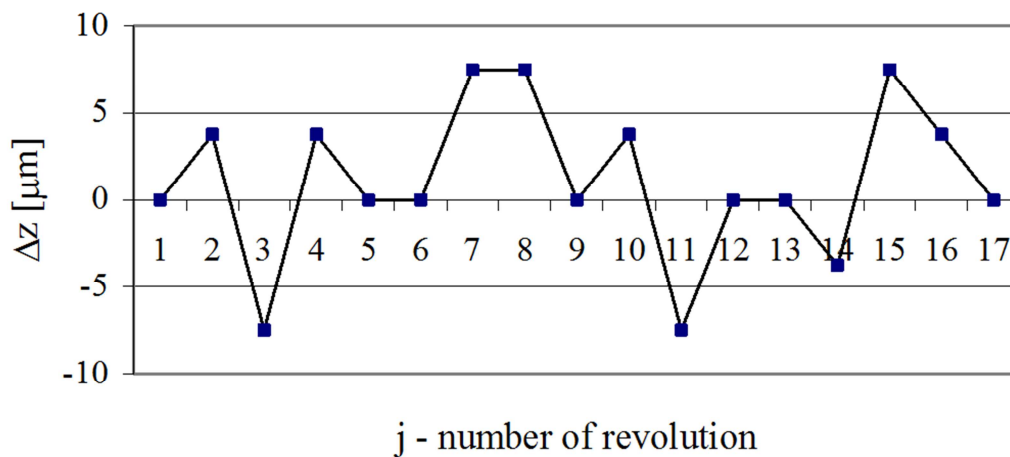

Fig. 9. Axial tool displacements against the workpiece selected in successive revolutions $j = 1, 2, \dots$ in the form of difference of their successive values from the feed value $f = 0.24 \text{ mm/rev}$ accepted for realization.

Radial displacements have the character of irregular changes located on both sides of the reference value of the feed per workpiece revolution. In interpreting these results we observe an irregular reproduction of the tool feed value having the character of a frequency disturbance.

Through representation of the tool edge, this disturbance affects also the heights of transverse irregularities of turned surfaces, as presented in Fig.10. The irregularities show a clear waviness of peaks, but the valleys remain at the same level, which has also the character of an amplitude modulation.

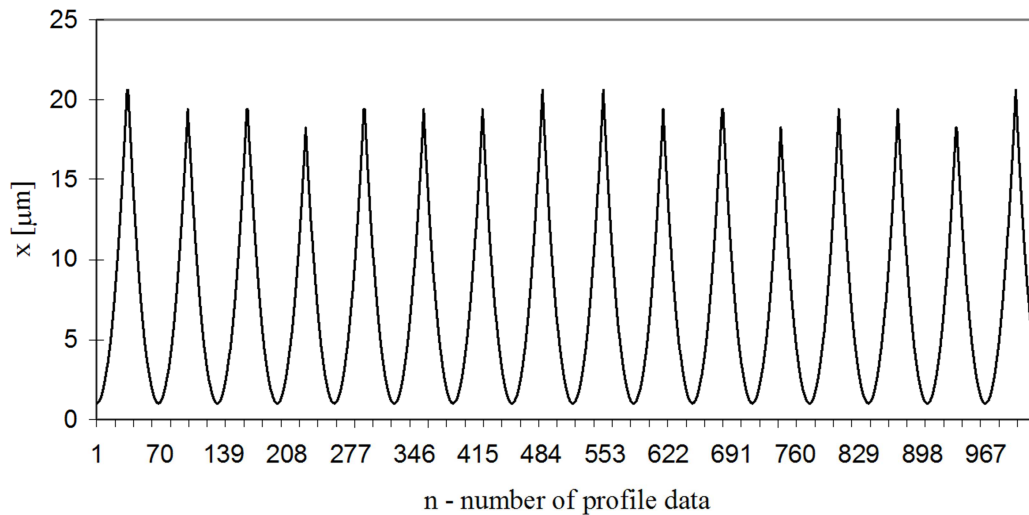

Fig. 10. Generated course of irregularities with curved projection of the tool edge with disturbances of parallel tool displacements against the perpendicular displacements of the tool to workpiece, sampling interval $h = 4 \mu\text{m}$.

5. Differentiation of the types of surface irregularity from the amplitude spectrum

The individual types of tool displacement relative to the workpiece introduce disturbances in the form of changes in height and length of the irregularities. These changes are weakly discernible in parameter values of irregularity height and length and they should be investigated through amplitude-frequency functions.

Radial displacement $(T-W)_x$ is essential for surface accuracy and, being a tooling disturbance with definite frequency constitutes an amplitude modulation of the tool edge representation. In the result of this process we notice an increase of irregularity heights with the tool moving away from the workpiece and a decrease of these heights when the tool moves toward the workpiece. Apart from this, the peak heights of irregularities shift in the length direction and produce frequency-change effects. Profile irregularities with radial disturbances of displacements $(T-W)_x$ contain a displacement of tool outline representations, manifested by variably positioned valleys (amplitude modulation) and clearly changing peak heights (modulated in amplitude and frequency). These disturbances, as irregularity envelopes, are represented in the amplitude spectrum (1) by a component group with low-frequency character of surface waviness, as presented in Fig.11.

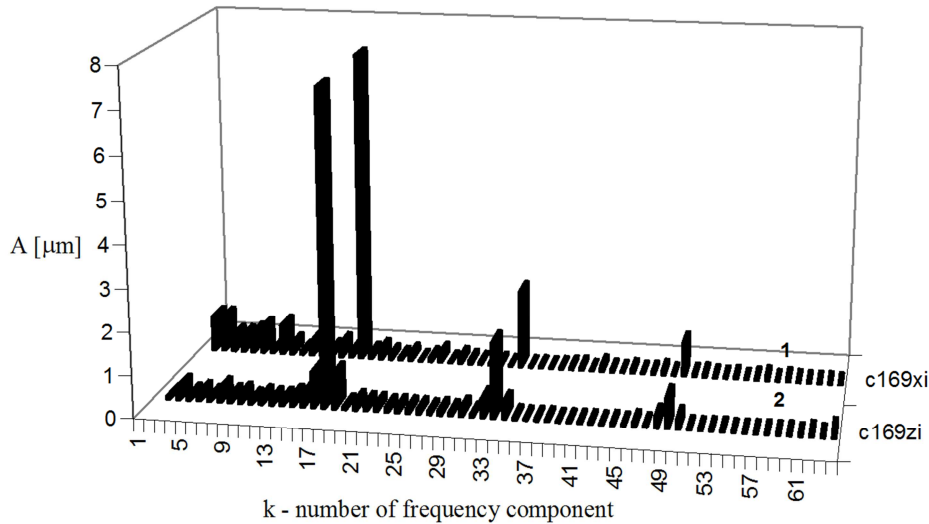

Fig. 11. Amplitude spectra of irregularities generated with radial (1) and axial (2) displacements of the tool with respect to of perpendicular displacements of the tool against the workpiece and curved representation of the tool envelope.

Profile irregularities with disturbances of displacements parallel to the surface $(T-W)_z$ have valleys situated at the same level. Irregularity peaks are slightly extended at varying distances, as irregular realization of tool feed per workpiece revolution (frequency modulation). Through representation of the tool envelope, in the irregularity profile the peaks are modulated in amplitude and frequency. In the amplitude spectrum (2) in Fig.11 this is depicted as spectral lines of sidebands of the main component $k = 16$ of the tool feed per workpiece revolution and its harmonics.

6. Conclusions

The machining system consists of the machine tool, the cutting tool and the workpiece involved in a machining process and the effects on the surface have their source in the individual elements of the system. In a turning process the ideal course of the tool edge is disturbed by its changing position with respect to the workpiece both in the perpendicular and parallel direction to the workpiece surface. Here, more significant to the aggravation of surface accuracy are tool displacements perpendicular to the workpiece surface.

In the transverse profile, changes in tool position against the workpiece are shown through placement of irregularity valleys in the representation of the tool edge per workpiece revolution. Relative displacements of the tool disturb the irregularities and modify the position of their peaks in the radial and axial directions. In effect, they constitute an amplitude-frequency modulation of the surface profile irregularity. These disturbances, as irregularity envelopes, are represented in the amplitude spectrum by a component group of low-frequency character of surface waviness. They generate waviness at frequencies lower than the main component of tool edge representation on the workpiece's surface.

Changes in perpendicular displacements of the tool in respect to the workpiece are more significant for shaping the irregularities than those in the parallel direction.

References

- [1] Sawabe, M., Fujimura, N. (1978). Influence of Radial Motion on Form Error of Workpiece in Turning. *Annals of the CIRP*, 27(1), 505–509.
- [2] Castro, H.F.F. (2008). A method for evaluating spindle rotation errors of machine tools using a laser interferometer measurement. *Measurement*, 41, 526–537.
- [3] Sekar, M., Srinivas, J., Rama Kotaiah, K., Yang, S.H. (2009). Stability analysis of turning process with tailstock-supported workpiece. *Int. J. Adv. Manuf. Technol.*, 43, 862–871.
- [4] Moon, K.S., Sutherland, J.W. (1994). The Origin and Interpretation of Spatial Frequencies in a Turned Surface Profile. *J. of Eng. for Industry*, 116, 340–347.
- [5] Zhang, G.M., Yerramareddy, S., Lee, S.M., Lu, S.C. (1991). Simulation of Surface Topography Formed During the Intermittent Turning Processes. *J. of Dynamic Sys. Measurement and Control*, (113), 273–279.
- [6] Lin, S.C., Chang, M.F. (1988). A study on the effects of vibrations on the surface finish using a surface topography simulation model for turning. *Int. J. of Machine Tools and Manufacture*, 38, 763–782.
- [7] Boryczko, A. (2010). Cylindrical surface irregularities presented by frequency spectra of relative tool displacement to the workpiece. *Measurement*, 43, 586–595.
- [8] Cheung, C.F., Lee, W.B. (2000). A theoretical and experimental investigation of surface roughness formation in ultra-precision diamond turning. *Int. J. of Machine Tools and Manufacture*, 40, 979–1002.
- [9] Whitehouse, D. J. (2002). *Surfaces and their Measurement*. Hermes Penton Ltd. London.
- [10] Fung, E.H.K., Yang S.M. (2001). An approach to on-machine motion error measurement of a linear slide. *Measurement*, 29, 51–62.
- [11] Costes, J.P., Moreau, V. (2011). Surface roughness prediction in milling based on tool displacement. *Journal of Manufacturing Processes*, 13, 133–140.
- [12] Wojciechowski, S. (2011). Machined surface roughness including cutter displacement in milling of hardened steel, *Metrology and Measurement Systems*, 18(3), 429–440.
- [13] Boryczko, A. (2011). Profile irregularities of turned surfaces as a result of machine tool interactions. *Metrology and Measurement Systems*, 18(4), 691–700.
- [14] Costes, J.P. (2013). A predictive surface profile model for turning based on spectral analysis, *Journal of Materials Processing Technology*, 213, 94–100.
- [15] Boryczko, A. (2002). Stereometry of turned surfaces in a frequency-domain formulation of irregularities. *Metrology and Measurement Systems*, 9(3), 261–271.