



THERMODYNAMIC ANALYSIS OF A GENERATION IV SCWR NUCLEAR POWER PLANT CYCLE

Jacek Frost, Marek Dzida

Gdańsk University of Technology
Ul. Narutowicza 11/12, 80-950 Gdańsk, Poland
Tel.: +48 58 3472135
e-mail: jacfrost@pg.gda.pl, dzida@pg.gda.pl

Abstract

This article presents a flow and thermodynamic analysis of a Generation IV nuclear cycle. An SCWR (Supercritical water reactor) is a high temperature and high pressure reactor that uses water at a temperature above its thermodynamic critical point as the working fluid. The cycle used for the calculations consists of one interstage superheater and 7 regenerative heat exchangers. Division pressure was optimized in view of the cycle efficiency, and the possibility of using another pressure value that would be more beneficial due to the structure of the grid of blades was mentioned.

Keywords: *nuclear reactors, steam turbines, thermodynamic cycles, SCWR reactors*

1. Introduction

Nuclear power engineering is currently on the rise; there are 66 nuclear power units under construction[1]. Because of the increasing interest in energy generation through nuclear fission, research is being conducted on the development of a new generation of nuclear reactors (Figure 1). Generation III reactors are currently being constructed, while works are pending on Generation IV that is to be characterised with:

- increased safety of reactors operation;
- increased proliferative immunity;
- minimization of radioactive waste generation;
- reduction of reactors construction and operation costs.

Evolution of Nuclear Power

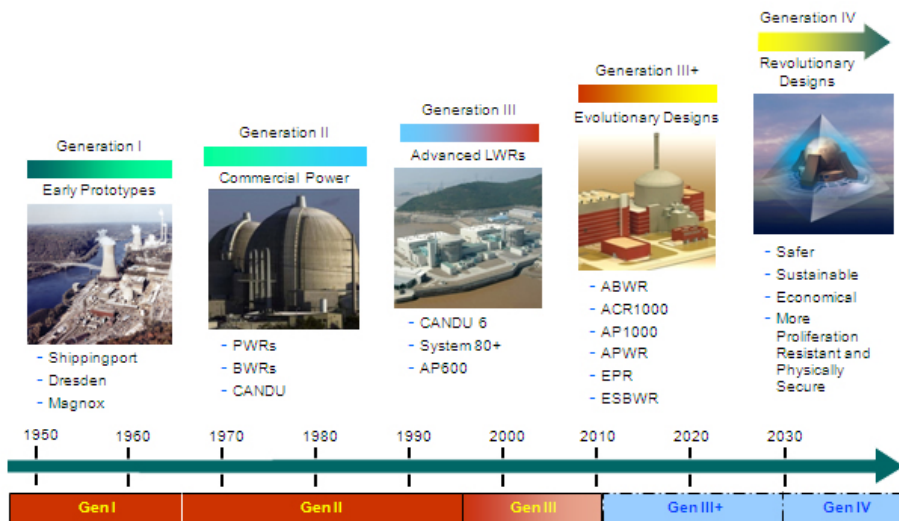

Fig. 1. Nuclear reactors evolution[3]

Generation IV reactors are expected to be put into operation following 2030. In this article a supercritical water reactor (SCWR) is the subject of a thermodynamic analysis. An SCWR reactor operation is based on two proven technologies: pressure reactors and conventional supercritical power units. The aim of SCWR reactors is to generate relatively inexpensive electric energy. A pictorial diagram of an SCWR reactor is given in Figure 2.

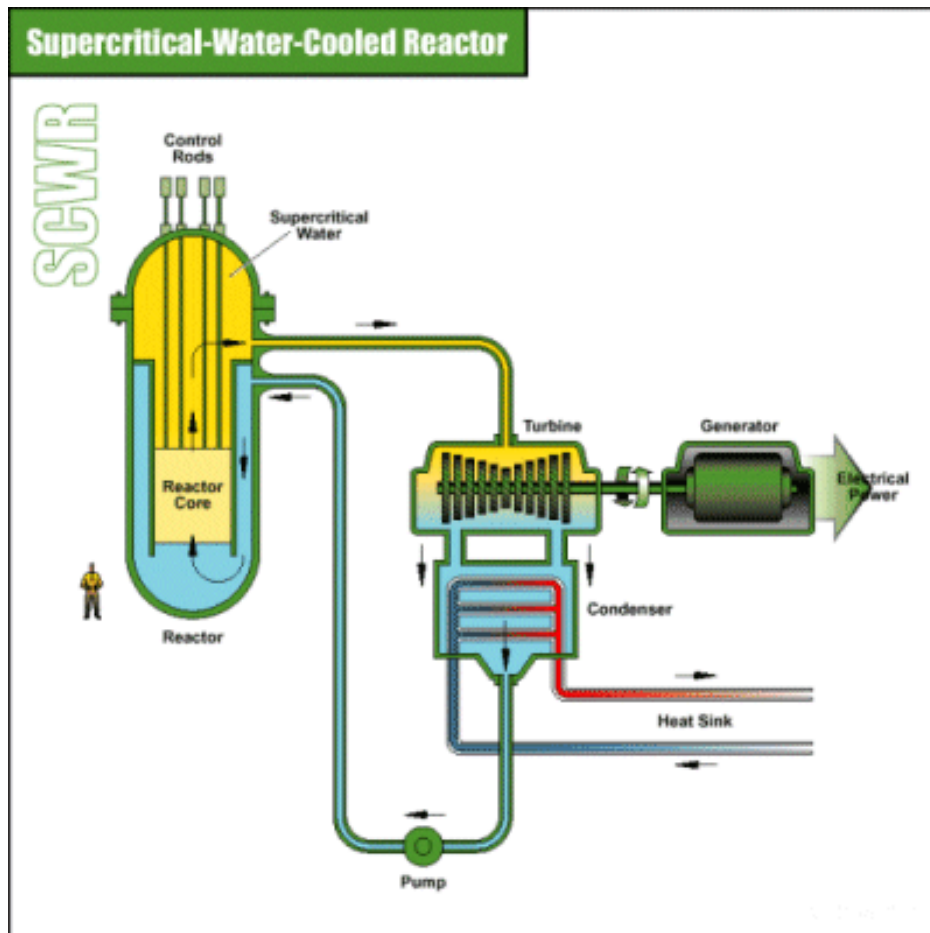

Fig. 2. Pictorial diagram of an SCWR reactor[4].

2. Thermodynamic cycle used for calculations

A thermodynamic cycle consists of a reactor in which water steam with the following parameters: $t_1 = 570^\circ\text{C}$ and $p_1 = 260 \text{ MPa}$ is generated. Temperature at the reactor inlet is 250°C . Steam enters a high pressure (HP) turbine where it expands to p_3 pressure that has been optimized in view of maximum efficiency of the cycle. Following expansion in the HP section steam enters the superheater. The cycle consists of 7 regenerative heat exchangers, 3 of which are supplied from the intermediate pressure (IP) section, while the next 4 are supplied from the low pressure (LP) section. A schematic diagram is given in Figure 3. The operation of a circulating pump was assumed for the calculations.

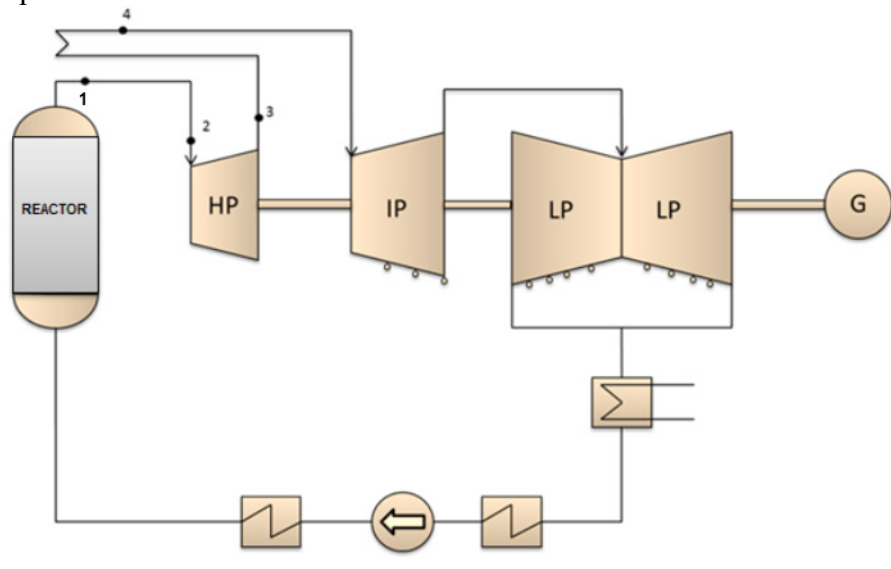

Fig. 3. Diagram used for the SCWR reactor calculations

Table 1 shows the values used for the calculations. The calculations were based on the generator shaft power, number of regenerative heat exchangers, efficiency of individual elements of the cycle.

Table 1. Values used for the calculations

No.	Parameters	Designation	Unit	Value
1.	Power	N_e	MW	182
2.	Pressure downstream of the reactor	p_1	bar	260
3.	Temperature downstream of the reactor	t_1	$^\circ\text{C}$	570
4.	Temperature downstream of the superheater	t_4	$^\circ\text{C}$	570
5.	Pipelines efficiency	η_R	-	0,95
6.	HP section efficiency	η_{HP}	-	0,92
7.	IP section efficiency	η_{IP}	-	0,94
8.	LP section efficiency	η_{LP}	-	0,9
9.	Pump efficiency	η_P	-	0,8
10.	Pressure in the condenser	p_k	bar	0,05
11.	Rotational speed	n	RPM	3000
12.	Number of regenerative heat exchangers	z	-	7

3. Optimization of division pressure downstream of the HP turbine

First of all, p_3 pressure was optimized in view of the cycle maximum efficiency. Maximum efficiency was obtained for $p_3 = 130,91$ bar, i.e. 0,53 of p_2 pressure. In references it may be found that the optimum value of p_3 pressure is within 0,2 and 0,25 of p_2 for conventional systems [5]. The efficiency for such a pressure value amounts to 48,2%. The curve of steam cycle division pressure in the function of efficiency is given in Figure 4. Further calculations were performed for various ratios of p_2/p_3 (Table 2) because of a minor difference in efficiency. Another value of p_3 pressure may be recommended due to structural reasons. Figure 5 shows enthalpy reduction at individual sections of the turbine. With the increase of p_3 pressure the HP section share drops, and the IP section share increases.

Table 2. Pressure and cycle efficiency

No.	p_3/p_2	p_3 pressure [bar]	Cycle efficiency
1.	0,3	74,1	0,476224
2.	0,4	98,8	0,479906
3.	0,53	130,91	0,481577
4.	0,6	148,2	0,481372

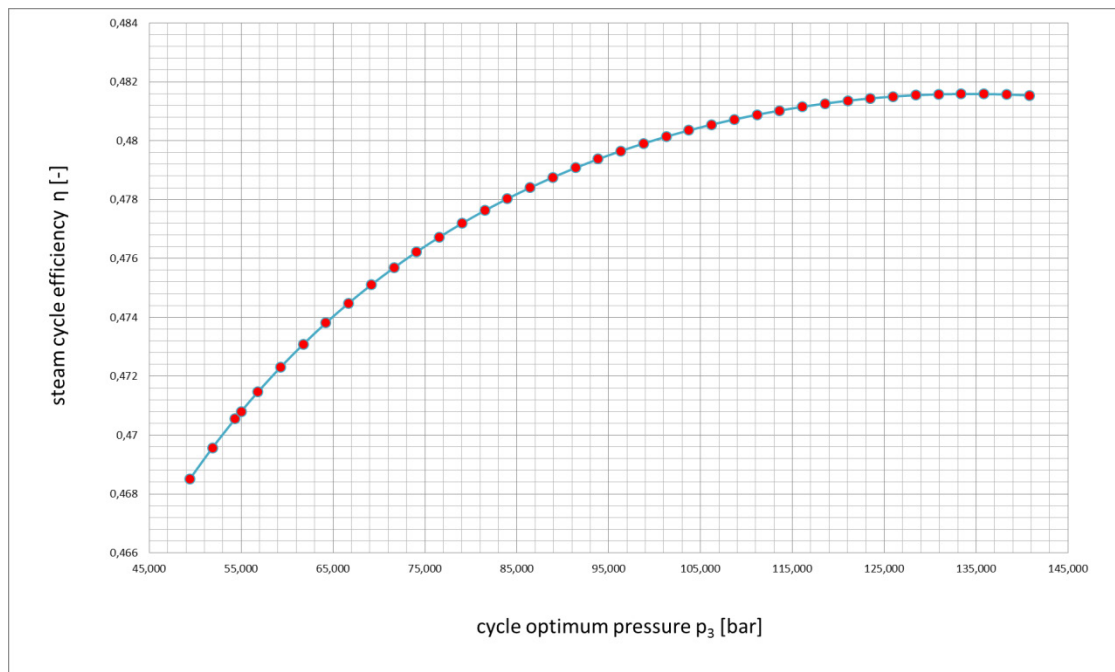

Fig. 4. p_3 pressure optimization curve

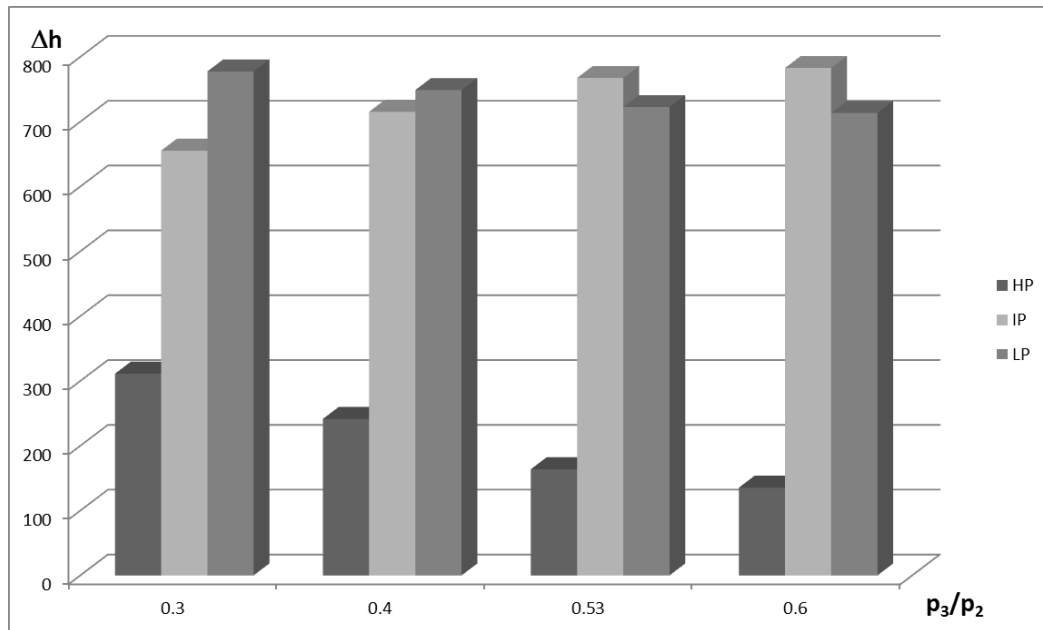

Fig. 5. Diagram of enthalpy reduction for various values of p_3 pressure

Figures 6, 7, 8, 9 show a percentage share of enthalpy reduction at individual cylinders of the turbine. Similarly to Figure 5, a decreased share of enthalpy reduction of the high pressure section and an increase in the case of the intermediate pressure section may be observed, while the share of enthalpy reduction of the low pressure section remains practically unchanged for all the analysed division pressures.

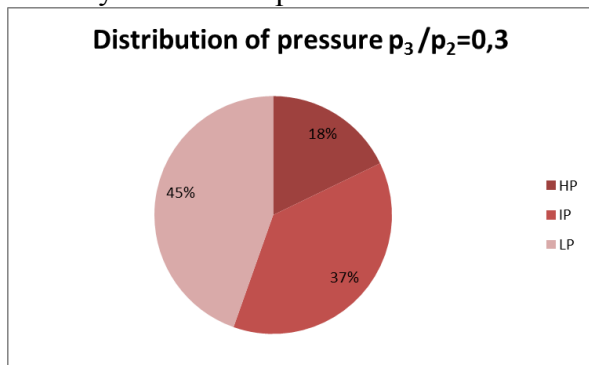

Fig. 6. Percentage distribution of enthalpy reduction at individual parts of cylinders for a division pressure ratio of 0,3

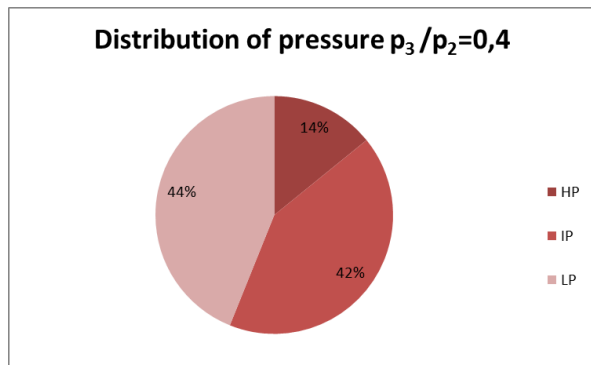

Fig. 7. Percentage distribution of enthalpy reduction at individual parts of cylinders for a division pressure ratio of 0,4

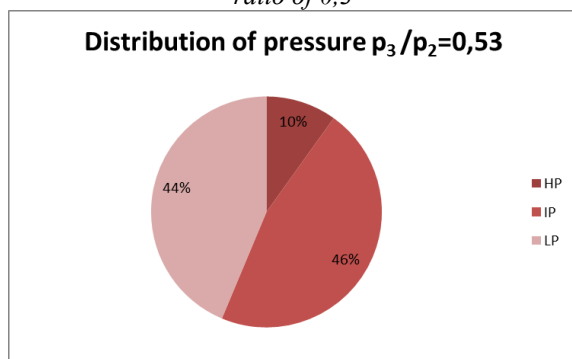

Fig. 8. Percentage distribution of enthalpy reduction at individual parts of cylinders for a division pressure ratio of 0,53

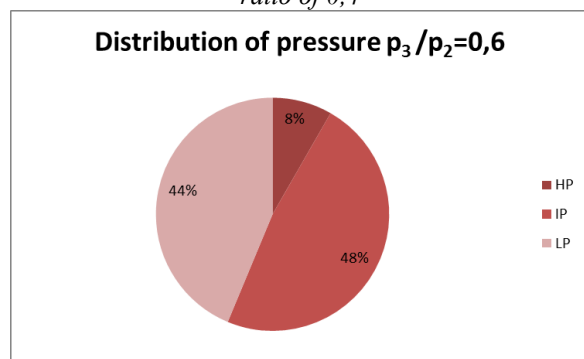

Fig. 9. Percentage distribution of enthalpy reduction at individual parts of cylinders for a division pressure ratio of 0,6

4. Flow channel design

The flow channel was designed for four division pressure variants. Because of the division pressure changes, the number of stages in the high pressure and intermediate pressure cylinders changed. The changes did not affect the low pressure cylinder.

Diagrams 10, 11, 12 and 13 show the shape of the high pressure channel for varying values of p_3 pressure; the number of stages drops with the increase of the division pressure. With the lowest division pressure there are eight stages. With the optimum division pressure value there are only four stages.

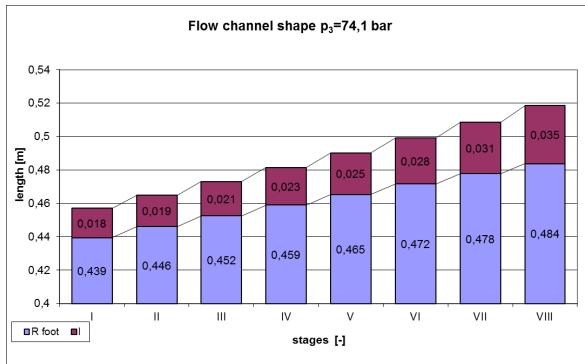

Fig. 10. HP flow channel shape for a division pressure ratio of 0,3 R foot – diameter foot, l – length blades

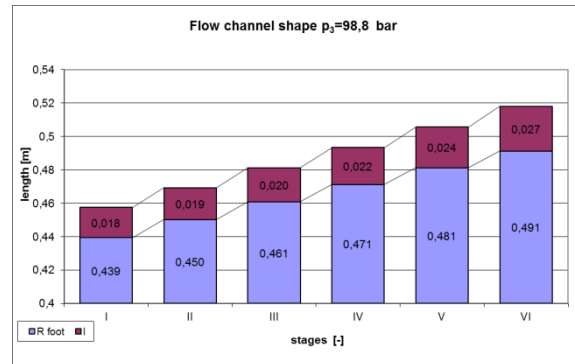

Fig. 11. HP flow channel shape for a division pressure ratio of 0,4

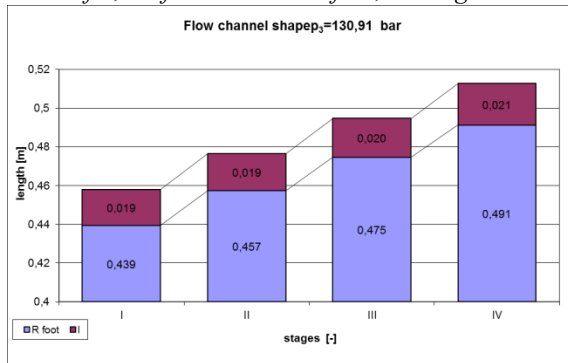

Fig. 12. HP flow channel shape for a division pressure ratio of 0,53

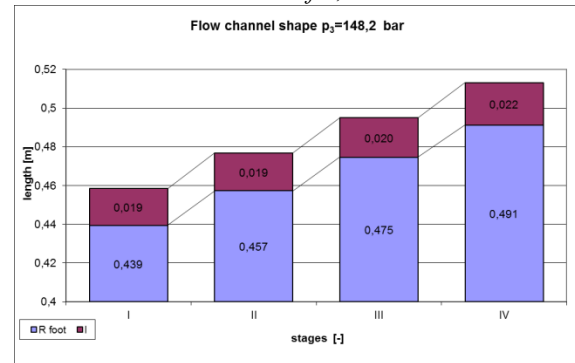

Fig. 13. HP flow channel shape for a division pressure ratio of 0,6

The number of stages in the IP channel rises from 12 to 16. Total number of stages of the HP and IP section for efficiency optimum pressure is 19, one less than in the case of division pressure lower than optimum.

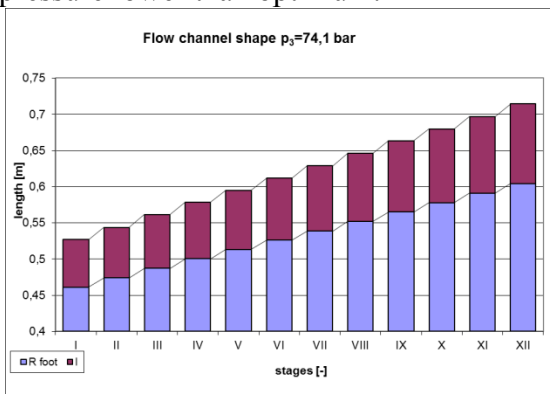

Fig. 14. IP flow channel shape for a division pressure ratio of 0,3

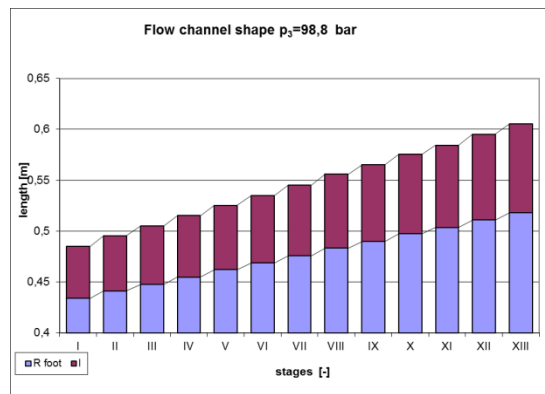

Fig. 15. IP flow channel shape for a division pressure ratio of 0,4

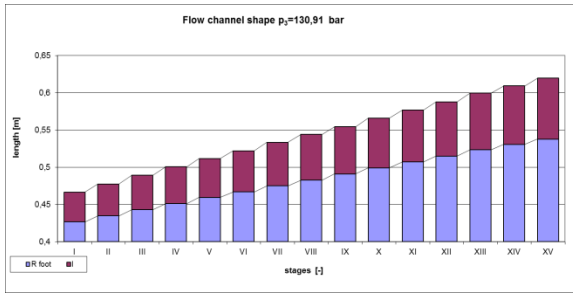

Fig. 16. IP flow channel shape for a division pressure ratio of 0,53

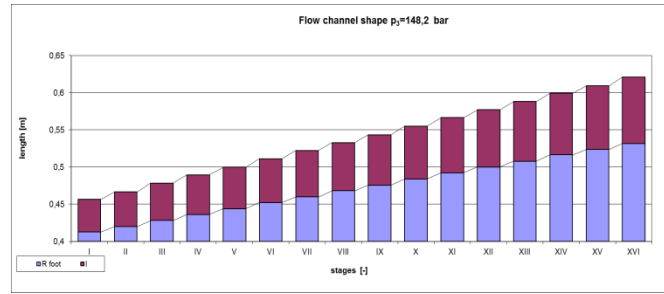

Fig. 17. IP flow channel shape for a division pressure ratio of 0,6

The number of cylinders was calculated for the low pressure section in accordance with the algorithm presented below. The steam mass stream flowing through the last stage of the LP turbine:

$$\dot{m} = 117,198 \left[\frac{kg}{s} \right] \quad (1)$$

Specific volume of steam downstream of the turbine:

$$\nu = 23,36 \left[\frac{m^3}{kg} \right] \quad (2)$$

Turbine outlet velocity:

$$c_2 = 250 \left[\frac{m}{s} \right] \quad (3)$$

Maximum permissible bending stress affecting the blade:

$$\sigma_{gr} = 350 [MPa] \quad (4)$$

Assumed ratio:

$$k = 0,383 [-] \quad (5)$$

Blade material density:

$$\rho = 8000 \left[\frac{kg}{m^3} \right] \quad (6)$$

Rotational speed:

$$\omega = 314 [RPM] \quad (7)$$

Boundary surface:

$$\Omega_{gr} = \frac{\sigma_{gr} \cdot 10^6 \cdot 2\pi}{k \cdot \rho \cdot \omega^2} = 7,279[m^2] \quad (8)$$

Effective area:

$$\Omega = \frac{\dot{m} \cdot v}{c_2} = 10,951[m^2] \quad (9)$$

Number of cylinders:

$$a = \frac{\Omega}{\Omega_{gr}} = 1,5 \approx 2 \quad (10)$$

The low pressure turbine was divided into two cylinders. The steam mass stream flowing through the turbine and bleeders mass streams were divided into two parts.

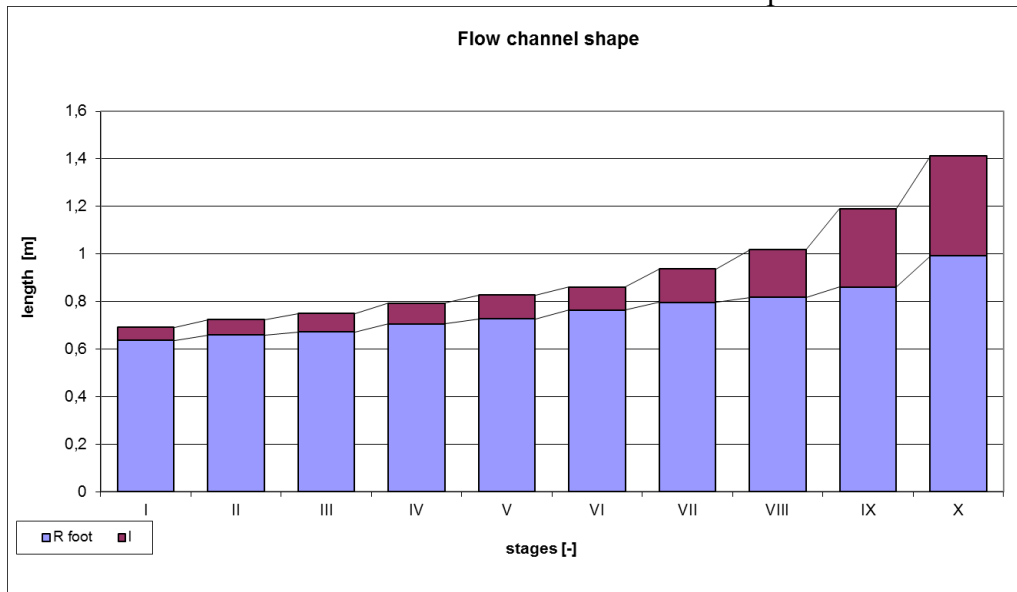

Fig. 18. LP flow channel shape

5. Summary

Analysing the obtained results we may conclude that the idea of SCWR reactors may constitute an inexpensive and effective source of electric energy generation. The calculations also prove that cycles with the above-mentioned reactors have a high efficiency. It should also be highlighted that the optimum division pressure is higher than in the case of conventional cycles. The analysis of flow channels shows that in some cases the adoption of a pressure value other than the optimum one may be more beneficial, due to the structure of the grid of blades.

References

- [1.] <http://www.mg.gov.pl/> 24.05.2014
- [2.] Mikielwicz J., Mikielwicz D., *Dziś i jutro technologii energetyki jądrowej- szanse i zagrożenia*, Energetyka Jądrowa w Polsce, Wolters Kluwer Polska Sp. z o.o, Warsaw 2012
- [3.] <http://www.elektroonline.pl/> 24.05.2014
- [4.] <http://www.inl.gov/> 24.05.2014
- [5.] Pawlik M., Strzelczyk F., *Elektrownie*, WNT, Warsaw 2012