

ADAPTIVE IDENTIFICATION OF TIME-VARYING IMPULSE RESPONSE OF UNDERWATER ACOUSTIC COMMUNICATION CHANNEL

IWONA KOCHAŃSKA

Gdańsk University of Technology
Faculty of Electronics, Telecommunications and Informatics
Department of Marine Electronic Systems
ul. Narutowicza 11/12, 80-233 Gdańsk, Poland
iwona.kochanska@eti.pg.gda.pl

The transmission properties of an underwater acoustic communication channel can change dynamically due to the movement of the acoustic system transmitter and receiver or to reflection by underwater objects of the transmitted signal. Time-varying impulse response measurement and estimation are necessary to match the physical layer of data transmission to instantaneous channel propagation conditions. The correlation measurement method, being limited to the duration of the measurement sequence, thereby limits. The paper proposes a joint correlation measurement and adaptive filtration approach, applying the Kalman filter algorithm to increase the time-domain resolution of the time-varying impulse response estimation.

INTRODUCTION

Underwater acoustic communication (UAC) systems are working in different environment conditions; thus, there is a diversity of underwater acoustic channels between the transmitter and receiver. Depending on the channel geometry, there is a problem of reflection and refraction, which leads to time dispersion of the transmitted signal. The Doppler effect, related to the movement of the UAC system transmitter or receiver, as well as the object reflecting the transmitted signal, and the current in the water column results in a time-domain scaling of the natural broadband communication signal. The magnitude, arrival time and Doppler shift of each multipath component (MPC) of the UAC impulse response can change dynamically. There is a need to develop and implement data transmission algorithms matching the UAC system physical layer parameters to dynamically varying transmission properties of the channel, in order to ensure the efficient performance in any propagation conditions [1].

The transmission properties of the UAC channel are calculated on the basis of its impulse response, measured with the correlation method, using linear frequency modulation (LFM) signals or pseudorandom binary sequences (PRBS), or using pilot tones in the modulation method

like preamble, midamble or postamble or pilot patterns. The disadvantage of this method is limited time-resolution of computed estimate of the linear time-variant (LTV) system impulse response (IR). A single estimate of the IR is limited to the duration of the measurement sequence, which, on the other hand, should be long enough to gather the energy of all relevant signal reflections reaching the UAC system receiver.

1. TIME-VARYING IMPULSE RESPONSE

The communication channel can be characterized by the tapped delay line (TDL) model represented by a time-variant FIR-filter [2]. The impulse response $h(t, \tau)$ of the channel is defined in the domain of two time variables: observation time t and delay τ . The values of t indicate the moments of subsequent IR measurements while τ denotes the position on the time axis of successive samples of the IR in a single observation. Figure 1 shows an example of impulse response $h(t, \tau)$.

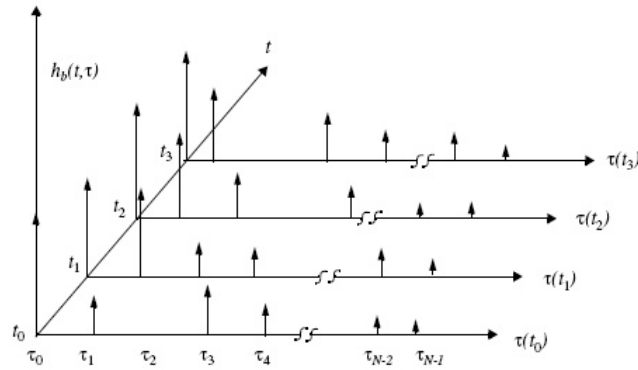

Fig.1. Time-varying impulse response [2].

The discrete model of time-varying impulse response (TVIR) can be described as $h[n, k]$, where $n = t/t_m$ and t_m is the time interval between subsequent IR observations, and $k = \tau/t_s$ with t_s being an IR sampling period. The discrete signal transmitted through the LTV channel can be denoted as:

$$r[n] = \sum_{k=0}^K s[n-k]h[n, k] \quad (1)$$

where $s[n]$ and $r[n]$ are the transmitted and received signals, respectively, and K is the number of samples of IR at a given observation time.

The TVIR is a basis for the computation of transmission characteristics, describing the channel statistically under the assumption of wide-sense stationary uncorrelated scattering (WS-SUS), providing information about the transmission parameters: delay spread T_d , Doppler spread B_D , coherence time T_c and coherence bandwidth B_c [3]. The parameters are used for adjusting the physical layer of data transmission to the communication channel propagation conditions. In case of a time-variant channel the accuracy of the instantaneous transmission parameters depends on the accuracy of the channel impulse response estimation.

Underspread and overspread channel

Depending on the relation of the impulse response delay spread T_D and its doppler spread B_D , the UAC channel can be classified as underspread or overspread. The product of T_D and B_D is called the *spreading factor* [2]:

$$T_d B_D = \frac{1}{T_c B_c} \quad (2)$$

If $T_d B_D < 1$, the channel is assumed to be underspread. Such a channel can have a long impulse response which varies slowly and can be measured with the use of a sufficiently long m-sequence or LMF signal. An underspread channel is also a channel that is changing rapidly, but its IR is short. A series of measurements by short testing signals allows for obtaining knowledge of the nature of the variation of such channel.

If $T_d B_D > 1$, the channel is called overspread. This is the case of a channel with long and rapidly varying IR. Measurement of TVIR of an overspread channel is extremely difficult and unreliable, if not impossible [4]. Measurement by a short sequence of measurements will allow for examining the variability of the channel, but the IR will show visible time-aliasing [5]. On the other hand, measuring with a long testing signal will result in correct collection of information about the distribution of the next MPCs on the timeline, but information about the channel variability will be lost.

IR measurement using M-sequences

The correlation measurement of the UAC channel impulse response can be performed using the m-sequences, i.e., a type of pseudorandom binary sequences, also known as maximum length sequences (MLS) [6]. The measurement system is shown in Fig. 2. The m-sequence is pre-processed with a pulse-shaping filter. After the digital to analog conversion and amplification, the signal is applied to the hydroacoustic transducer. The receiver consists of the hydrophone, the amplifier, the analog-to-digital converter and filter, and the digital signal processing stage, which includes the circular convolution of the received signal and the transmitted m-sequence.

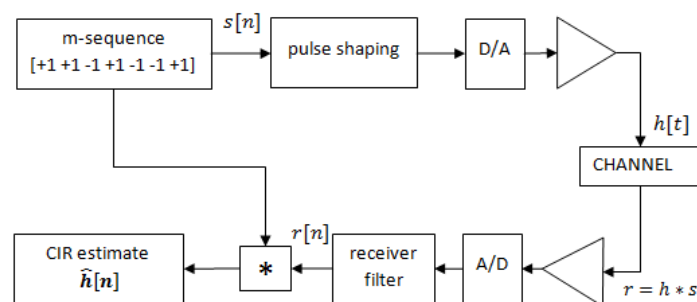

Fig.2. The UAC impulse response measurement system using M-sequences.

The autocorrelation function R_s of the M-sequence is similar to the Dirac delta, thus at the output of the measurement system the IR estimate $\hat{h}[n]$ of the unknown $h[n]$,

$$\hat{h}[n] = (r * s)[n] = (s * h * s)[n] = (h * R_s)[n], 0 \leq n < K, \quad (3)$$

is obtained where K is the number of samples of the m-sequence $s[n]$. In the case of an LTV system, the received signal $r[n]$ is described as in Eq. 1. Thus, after the correlation with the m-sequence $s[n]$, a single IR estimate $\hat{h}[n]$ can be described as follows:

$$\hat{h}[n] = (r * s)[n] = \sum_{k=0}^K r[k]s[n-k], 0 \leq n < K, \quad (4)$$

with $r[k] = \sum_{m=0}^K s[k-m]h[k,m]$.

Fig. 3 shows the results of the simulation of TVIR measurement in the Matlab environment. The TVIR coefficients are varying in a random manner at the rate of 8000 times per second. The TVIR is measured with the m-sequence of rank of 12.

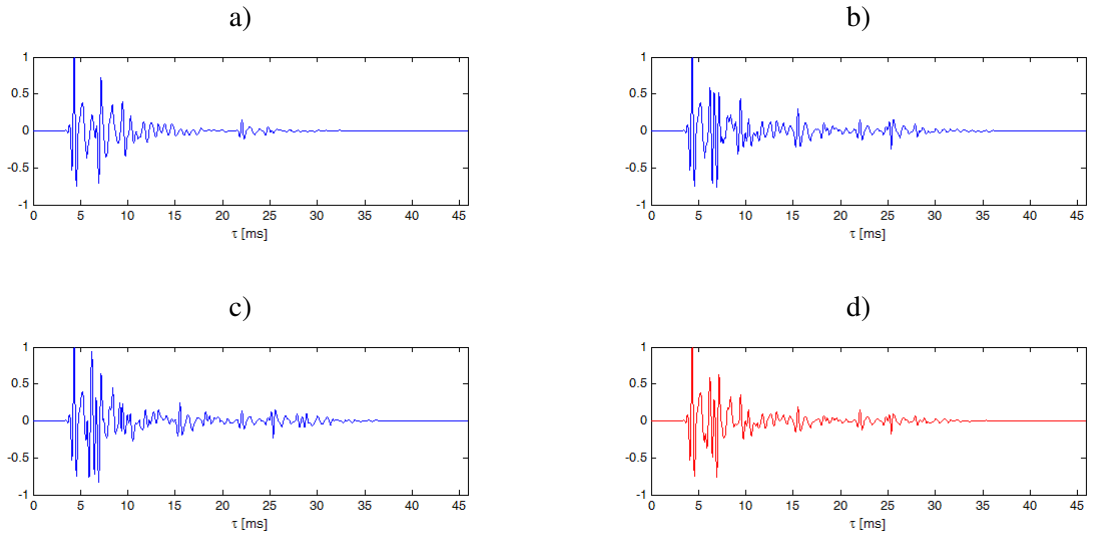

Fig.3. Simulated TVIR at three different observation times: $h[k_1, n]$ (a), $h[k_2, n]$ (b), $h[k_3, n]$ (c), and the IR estimate $\hat{h}[n]$, measured with the use of m-sequence (d).

Repeating the transmission of the m-sequence $s[n]$ gives a series of channel IR estimates $\hat{h}_p[n]$, $p = 0, 1, \dots, P$ at the output of the measurement system. If the channel is underspread, the accuracy of subsequent estimates $\hat{h}_p[n]$ and $\hat{h}_{p+1}[n]$ can be sufficient for the designing process of the physical layer of the data transmission system. However, in the case of an overspread channel, the time-variations of the TVIR, during the time interval between every two measurement time indices p and $p+1$ can be significant; nevertheless, this knowledge cannot be obtained directly from the IR measurement by the correlation method.

2. JOINT CORRELATION MEASUREMENT AND ADAPTIVE FILTRATION

Additional knowledge about the impulse response variations between its two subsequent estimates $\hat{h}_p[n]$ and $\hat{h}_{p+1}[n]$ can be obtained from the received m-sequence $r[n]$. The estimate $\hat{r}[n]$ of the received signal can be computed as the convolution of the m-sequence $s[n]$ and the estimate $\hat{h}[n]$, thereby resulting in a simulation of signal $s[n]$ transmission through the channel characterized with $\hat{h}[n]$:

$$\hat{r}[n] = \sum_{m=0}^K \hat{h}[n]s[n-m], 0 \leq n < K, \quad (5)$$

The error of estimation of $r[n]$ is equal to:

$$d[n] = r[n] - \hat{r}[n] = \sum_{m=0}^K s[n-m] (h[n,m] - \hat{h}[n]), 0 \leq n < K \quad (6)$$

In above equation the difference:

$$f[n,k] = h[n,k] - \hat{h}[n], 0 \leq n < K \quad (7)$$

can be interpreted as the fluctuation of the impulse response instantaneous value $h[n,k]$ over some “mean” value equal to the estimate $\hat{h}[n]$. Such decomposition of the TVIR can be used to solve the problem of identifying the variations between two subsequent estimates $\hat{h}_p[n]$ and $\hat{h}_{p+1}[n]$ at the output of the correlation receiver. For the estimation of $f[k,n]$ adaptive filtration can be applied.

Fig. 4 shows a block scheme of the joint correlation measurement and adaptive filtration (CMAF) algorithm for TVIR estimation.

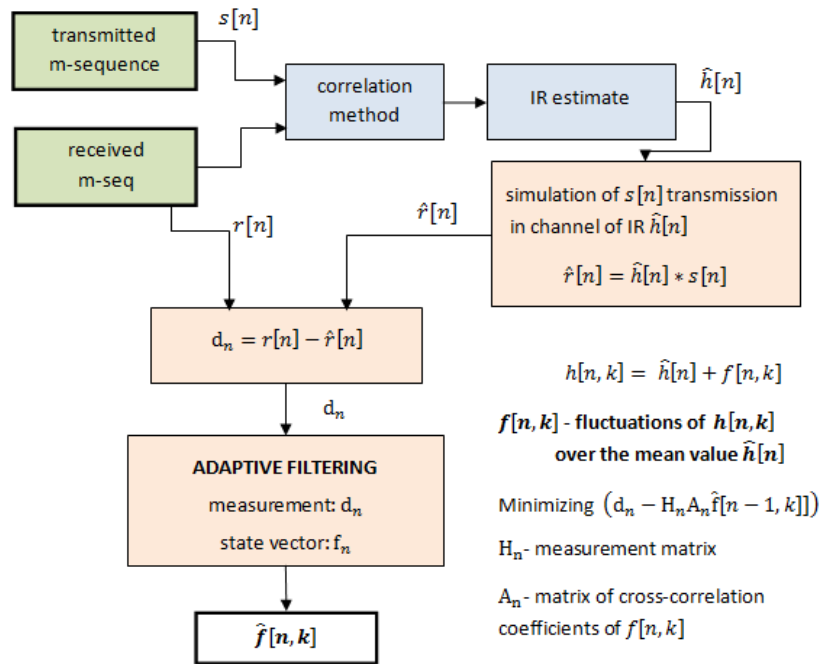

Fig.4. Block scheme of the joint correlation measurement and adaptive filtration (CMAF).

The IR of the time-varying channel is measured using the correlation method. The recorded sequence $r[n]$ is convolved with the transmitted one $s[n]$ and the estimate $\hat{h}[n]$ of the “mean” impulse response is obtained. Next the m-sequence $s[n]$ transmission through the channel described with the $\hat{h}[n]$ is simulated. The difference $d[n]$ between the resulting output signal $\hat{r}[n]$ and measured signal $r[n]$ is the input for the adaptive filter calculating the TVIR fluctuations $f[n, k]$ over the estimate $\hat{h}[n]$.

As it is shown in [7], the fluctuations $f[n, k]$ of the TVIR coefficients $h[n, k]$ can be modeled as an autoregressive processes (AR) of the rank $r = 2$:

$$f[n, k] = a[k]f[n-1, k] + u[n], \quad (8)$$

were $a[k]$ are the autoregression coefficients, and $u[n]$ is the noise of zero expected value and variance σ . Identification of such a process can be performed using the adaptive Kalman filter. The state equation of adaptive filtration can be formulated with the state vector \mathbf{f}_n constructed from the process $f[n, k]$ samples being searched:

$$\mathbf{f}_n = \mathbf{A}_n \mathbf{f}_{n-1} + \mathbf{v}_n, \quad (9)$$

where \mathbf{v}_n is the process noise vector and:

$$\mathbf{f}_n = \begin{bmatrix} f[n, 0] \\ f[n, 1] \\ \vdots \\ f[n, K] \end{bmatrix}, \quad \mathbf{A}_n = \begin{bmatrix} \alpha_{0,0} & \alpha_{0,1} & \cdots & \alpha_{0,K} \\ \alpha_{1,0} & \alpha_{1,1} & \cdots & \alpha_{1,K} \\ \vdots & \vdots & \ddots & \vdots \\ \alpha_{K,0} & \alpha_{K,1} & \cdots & \alpha_{K,K} \end{bmatrix}.$$

The elements α of \mathbf{A}_n are the cross-correlation coefficients of the processes $f[n, k]$ (the $\alpha_{l,m}$ is a cross-correlation coefficient of processes $f[n, l]$ and $f[n, m]$). The observation equation has the following form:

$$\hat{\mathbf{d}}_n = \mathbf{H}_n \mathbf{f}_n + \mathbf{w}_n, \quad (10)$$

where $\hat{\mathbf{d}}_n$ is the estimate of differential signal $d[n]$, \mathbf{w}_n is the observation noise vector and \mathbf{H}_n is the measurement matrix containing the samples of signal $d[n]$.

The Kalman filter is a recursive estimator, consisting of two steps [8]. First, the a priori estimates of the state vector $\hat{\mathbf{f}}_{n|n-1}$ and its covariance matrix $\mathbf{P}_{n|n-1}$ are predicted:

$$\begin{aligned} \hat{\mathbf{f}}_{n|n-1} &= \mathbf{A}_n \hat{\mathbf{f}}_{n-1|n-1} \\ \mathbf{P}_{n|n-1} &= \mathbf{A}_n \mathbf{P}_{n-1|n-1} \mathbf{A}_n^T + \mathbf{Q}_n \end{aligned}$$

Next, their a posteriori estimates $\hat{\mathbf{f}}_{n|n}$ and $\mathbf{P}_{n|n}$ are computed in the update stage of the algorithm:

$$\begin{aligned} \mathbf{S}_n &= \mathbf{H}_n \mathbf{P}_{n|n-1} \mathbf{H}_n^T + \mathbf{R}_n \\ \mathbf{K}_n &= \mathbf{P}_{n|n-1} \mathbf{H}_n^T \mathbf{S}_n^{-1} \\ \hat{\mathbf{f}}_{n|n} &= \hat{\mathbf{f}}_{n|n-1} + \mathbf{K}_n (\mathbf{d}_n - \mathbf{H}_n \hat{\mathbf{f}}_{n|n-1}) \\ \mathbf{P}_{n|n} &= \mathbf{P}_{n|n-1} - \mathbf{K}_n \mathbf{H}_n \mathbf{P}_{n|n-1} \end{aligned}$$

The Kalman filter minimizes the difference between measured difference \mathbf{d}_n and the product of measurement matrix \mathbf{H}_n and a priori estimate $\hat{\mathbf{f}}_{n|n-1}$. The result of the adaptive filtration is the estimate of IR fluctuations $\hat{f}[n, k]$. The CMAF estimate of the TV-IR is a sum of the estimate $\hat{h}[n]$ and fluctuations $\hat{f}[n, k]$.

3. SIMULATION TESTS

The joint correlation measurement and adaptive filtration, as shown in Fig. 4, was performed in simulation tests in the Matlab (R14) environment. The impulse response of the UAC channel was modeled as the TDL of different length intervals $10 \leq L \leq 150$ and $M = 5$ MPCs (fig. 5). The coefficients $h[n, k]$ of the IR are varying with the frequency $f_s = 48000$ times per second as independent random processes with variance $0.01 \leq \sigma_x \leq 0.5$. Thus, the autoregression matrix \mathbf{A}_n is diagonal with elements on the main diagonal equal to one.

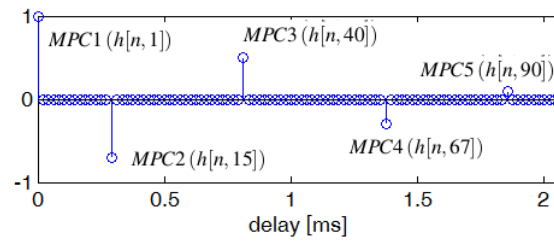

Fig.5. Initial impulse response of length $L = 100$ for simulation tests.

According to the scheme shown in Fig. 4., the IR estimates $\hat{h}_p[n]$, where $0 \leq p \leq P - 1$, are computed with the correlation measurement method. Next, the convolution of m-sequence $s[n]$ and the estimate $\hat{h}_p[n]$ is calculated to obtain the estimate of the received signal $\hat{r}[n]$. The differential signal $d[n]$ is filtered adaptively with the Kalman filter algorithm and the estimate of IR fluctuations $\hat{f}[n, k]$ is computed.

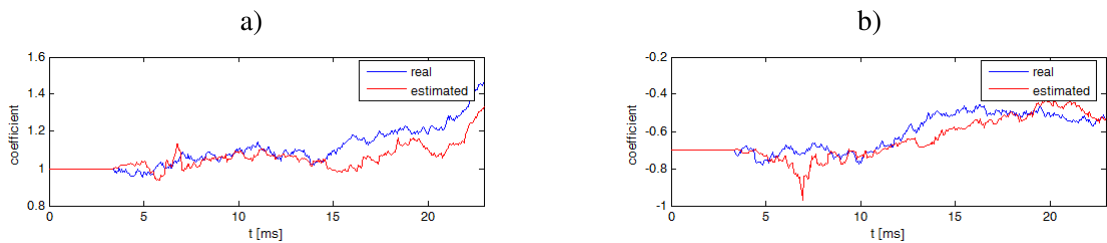

Fig.6. CMAF estimation of IR coefficients: $h[n, 1]$ corresponding to first MPC (a) and $h[n, 15]$ corresponding to second MPC (b).

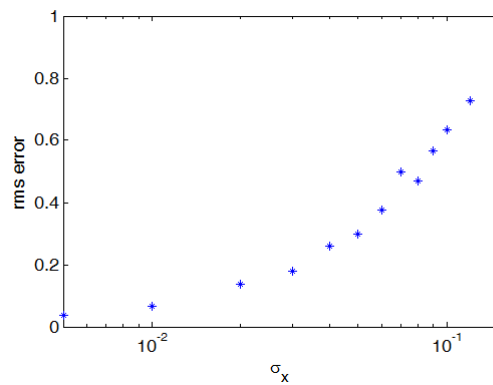

Fig.7. The RMS error of CMAF estimation of TVIR as a function of the variance σ_x of TVIR coefficients.

Fig. 6 shows the simulated time-varying impulse response $h[n, k]$ coefficients: $h[n, 1]$ corresponding to first MPC (a) and $h[n, 15]$ corresponding to second MPC (b), as well as estimates computed due to the CMAF technique. The time resolution of the coefficient estimates corresponds to the f_s since the classical correlation measurement method provides only one IR estimate per time duration of the test m-sequence (about 2ms in this case).

The RMS error of CMAF estimation of the TV-IR, as a function of the variance σ_x of the TVIR fluctuation process $f[n, k]$, is shown in Fig. 7. The tests have shown that the increase of the estimated IR duration has no significant influence on the estimation error. However, the

computational complexity of Kalman filter algorithm is cubic, due to the operations of matrix multiplication and inversion. This results in a significant increase in the signal processing time and memory used in case of UAC IR of several tens or hundreds of milliseconds (corresponding to distances of several tens or hundreds of meters). That indicates a need for sparse processing to adaptively filter only those IR coefficients that have been identified as significant MPCs.

5. CONCLUSIONS

The result of correlation measurement of the time-varying UAC channel IR is the estimate averaged over the duration of measurement signal. Its time resolution can be increased using the CMAF, thus the the accuracy of calculating the transmission characteristics can be also increased. The CMAF method can be particularly useful for overspread UAC channel parameters estimation, for which the classical IR correlation measurement method is not possible.

To save computing resources, which in case of UAC systems are usually strongly limited, the method should be improved by the use of sparse signal processing. This would make the method useful for adaptive equalization in UAC systems [9], in particular, those using correlation reception, such as direct sequence spread spectrum (DSSS) systems [10], and for the estimation of target positions in hydrolocation systems using PRBS signals [11].

The simulation tests were performed on the assumption that the TV-IR is composed of statistically independent MPCs. This is a rare case among the real UAC channels, in which successive signal reflections reaching the UAC system receiver are often strongly correlated. The influence of this correlation on the CMAF results will be the subject of further research.

References

- [1] I. Kočańska, H. Lasota, Testing OFDM Transmission Schemes for Shallow Water Acoustic Communications, *Hydroacoustics of Shallow Water*, Warszawa, 2013, pp. 210-226.
- [2] T. S. Rappaport, *Wireless Communications: Principles and Practice*, Prentice Hall, 2002.
- [3] I. Kočańska, H. Lasota, Investigation of underwater channel time-variability influence on the throughput of OFDM data transmission system, *Proceedings on Meetings on Acoustics*, POMA, 17, Acoustical Society of America, 2012.
- [4] E. Biglieri, *Coding for Wireless Channels*, Springer 2006.
- [5] P. Walree, Channel sounding for acoustic communications: techniques and shallow-water examples, FFI-rapport 2011/00007 2011.
- [6] R. Mazurek, H. Lasota, Application of maximum-length sequences to impulse response measurement of hydroacoustic communications systems, *Hydroacoustics* vol. 10, pp. 123-130, 2007.
- [7] W. Li, Estimation and Tracking of Rapidly Time-Varying Broadband Acoustic Communication Channels, PhD thesis, Massachusetts Institute of Technology, 2006.
- [8] R. Isermann, M. Munchhof, *Identification of Dynamic Systems*, Springer 2011
- [9] I. Nissen, Adaptive Systems for Mobile Underwater Communications with a P(oste)riori Channel Knowledge, FWG report, Vol. 59, 2008.
- [10] J. Schmidt, Reliable underwater communication system for shallow coastal waters, *Hydroacoustics* vol. 17, pp. 171-178, 2014
- [11] R. Salamon, J. Marszał, J. Schmidt, M. Rudnicki, Silent sonar with matched filtration, *Hydroacoustics* vol. 14, pp. 199-208, 2011.