

# Influence of Self-Similar Traffic Type on Performance of QoS Routing Algorithms

Michał Czarkowski, Sylwester Kaczmarek, and Maciej Wolff

**Abstract**—Providing a Quality of Services (QoS) into current telecommunication networks based on packet technology is a big challenge nowadays. Network operators have to support a number of new services like voice or video which generate new type of traffic. This traffic serviced with QoS in consequence requires access to appropriate network resources. Additionally, new traffic type is mixed with older one, like best-effort. Analysis of these new and mixed traffic types shows that this traffic is self-similar. Network mechanisms used for delivery of quality of services may depend on traffic type especially from the performance point of view. This paper presents a feasibility study done into the effect of traffic type influence on performance of routing algorithm while the routing algorithm is treated as one of the mechanisms to support QoS in the network.

**Keywords**—self-similar traffic, QoS routing, performance, simulation

## I. INTRODUCTION

THE evolution of current telecommunications networks is mostly focused on packet networks [1]. These networks have to support not only typical Internet traffic of high throughput without requirements on quality, but also existing common services like voice and video. Unfortunately, these networks until recently have not supported quality which is necessary for newly added services. In order to enable the provision of these services network operators applied oversized links between nodes. This is not a good approach, especially for overloaded networks. A better approach is to use effective mechanism inside the network like routing, access control, etc. in order to control and prevent overloading and supply required quality with focus to cost of the solution and requirement to optimize return of investments.

One of the architecture which was proposed to guarantee quality of services in networks is Differentiated Services (DiffServ) architecture [2]. In DiffServ we distinguish two types of nodes: edge routers and core routers. Before admitting traffic to the network the edge router checks whether incoming traffic can be serviced by the network with requested quality. Traffic is accepted and added to the network if the network has enough resources and requested quality could be guaranteed. In other cases demand is rejected. Such a check is performed for the whole incoming traffic into the network. In the next step edge and core routers service traffic according to the policy defined in contract. In this paper DiffServ architecture is assumed for research on the performance of QoS routing

algorithm. Results of these research are more generic and results should be similar in other architectures.

One of the factors which affect quality of services and networks performance is characteristic of incoming traffic. A specific type of traffic is self-similar traffic [4]. Consideration of this area demonstrates that self-similar traffic type is commonly present in most of current packets networks, and in consequence this traffic type should be the basic one considered in research on DiffServ networks [4].

In this paper we present that self-similar traffic affects network performance. We used two algorithms: simple and popular – OSPF [17], and author's with multipath support DUMBRA[14]. We present how network performance (with focus to transferred traffic amount) depends on routing algorithm.

There are several research results dedicated to this topic, but all these results apply only to simple networks [5][6][7].

The rest of the text is organized as follows. The second section shortly reminds used routing algorithms while the third section presents evaluation model based on simulation approach. The fourth section demonstrates simulation scenarios and all variables taken into consideration which affect the results of the experiments and the results analysis. The final section presents conclusions.

## II. ROUTING ALGORITHMS

Two routing algorithms were used in these studies: OSPF [17] and DUMBRA [14]. OSPF algorithm was used as the simplest, commonly known and used routing algorithm and here is applied with static metric. DUMBRA algorithm was used as simple implementation of K-SPF routing algorithm with selected path to support QoS.

OSPF is a widely known routing algorithm which does not require a detailed explanation. It should be emphasized that OSPF means routing protocol and routing algorithm. In this paper we always write about routing algorithm. We use OSPF with typical static metric that depends only on the capacity of links between nodes. We applied this routing in DiffServ architecture so that it allowed support of QoS. Still paths used by the network do not depend on QoS, because they do not depend on the current condition of the network, but only on the static parameter, i.e. link capacity.

DUMBRA routing algorithm was used because it is a simple proposal of multi-path routing including QoS needs. In this algorithm four paths from the source to the destination are calculated based on the classical metric from OSPF. The traffic between particular relations is forwarded via one path, but chosen within four paths. This selection depends on the current network state. Packets loss, delay and delay variation for each relation are measured. If specified parameters for a rela-

tion and traffic class are worse than expected, the path currently used to forwarding packets in this relation is changed to one of the three others. This process is continuously repeated, but the path for every relation is changed no more than once in five minutes. A five-minute interval between re-calculation of the path connecting each source and destination node is a result of other studies [19]. This is the shortest interval, for which the switching between paths has a sufficiently small impact on the change of the order of packets in the destination. More information about DUMBRA algorithm can be found in [14].

This is obvious that routing not affects QoS offered by the network, but amount of traffic serviced by the network with particular QoS depends on the routing algorithm and traffic type and can vary in terms of the efficiency. Routing algorithm which serviced more traffic without changing QoS allows admitting more traffic into the network. It means that we can increase amount of accepted traffic by admission control (AC) function.

### III. EVALUATION MODEL

An analytical approach for the performance analysis within QoS is complicated and difficult to apply in packet networks without many simplifications. The analytical model for real networks with many nodes and links, complex serviced system architecture, including routing phenomena consists of many state and transients equation, thus solving it could take a lot of time if at all possible [8]. That was the reason why the authors decided to use simulation model for evaluation of performance of routing algorithms for different traffic types. The authors also pays attention to the use of real network structures (the complicated ones).

Results within this research are collected for two traffic types: Poisson traffic and self-similar traffic. Poisson traffic was chosen because it is the simplest, commonly used in many simulations, and analysis. Self-similar traffic was chosen because it is the type of traffic occurring in real packet networks.

In the simulation model Poisson traffic was generated by exponential distribution. Multiplexed ON-OFF model [9] was used in order to generate self-similar traffic. In this model many ON-OFF traffic sources are multiplexed. The duration of the ON state of each of these sources is described by the Pareto distribution, and in this state packets are generated at a constant rate. The duration of the OFF state is described by the exponential distribution and in this state no packets are generated.

The simulation model was implemented in Omnet++, the discrete event network simulator [10]. This model implements DiffServ architecture and itself consists of three different network components: edge nodes, core nodes and central module. Edge nodes and core nodes realize the functions specified by this architecture. Both node outgoing service systems are the same and specified by the DiffServ architecture. The functional block diagram of service system is presented in Fig 1. Such a service system consists of two queuing policies: the priority queuing (PQ) and the weighted fair queuing (WFQ). Streaming traffic is directed to the first queue of PQ and contains very short buffer (REM approach) only for a few packets. Two other traffic classes (the elastic and the best effort respectively) are directed to WFQ with  $\omega_{AF}$  and  $\omega_{BE}$  weight

parameters. The output from WFQ is directed to the second input of PQ without additional buffering. This model of service system is a result of analysis of recommendations which described DiffServ architecture [2][21]. Packets are generated in edge nodes for all three traffic classes. The single generator of traffic class generated packets to all possible edge nodes (all relations). For any details of functional block diagram refer to [11].

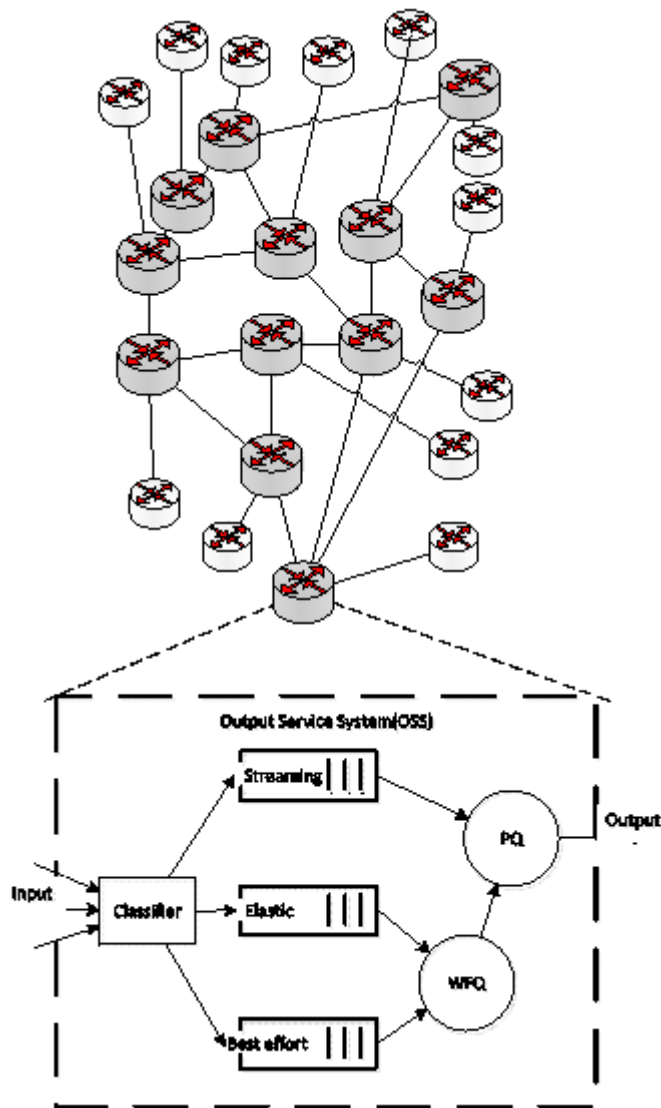

Fig. 1. Architecture of output service system.

Measurement block placed in central module checks QoS values such as delay, delay variation and lose ratio for all packets serviced in the network. Measurements are performed in edge nodes and results of these are periodically send to central module. If these QoS values are worse than described in [12] the central module does not admit more traffic to the network (AC function).

Applying the above model for real networks with many nodes requires high computational power. Some limitations for the model were applied in order to reduce this complexity and to be able to perform simulation in timely manner. Core links have the capacity of 3.5 Mbit/s to easily receive network

overload without generating too much traffic events in the simulation model. Border links have the capacity of 20Mbit/s up to unlimited traffic for core links. Research was made only for one value of Hurst parameter which is closer to traffic in real networks.

IV. RESULTS ANALYSIS

Simulation has been applied into four selected network structures: Sun, New York, Norway and TA1. Structures have been taken from sndlib library [13]. Sun is a simple structure with small number of nodes and links between them. New York is real structure of New York city network and it is characterized by a small numbers of nodes and a relatively large number of links between them. Norway structure represents real network of Norway and it has a large number of nodes and small number of links between them. TA1 is a hypothetical network structure with a large number of nodes and connections between them with a tailed approach. Details about number of nodes or links and density parameter are available in Table I. We assumed that network structures from [13] are core network and to each core node we attached edge node as a traffic entry point. In the paper we present the summary quality comparison for all these structures in Table I and also details in figures for two structures: New York and TA1. More results for these structures for Poisson traffic type are available in [14]. Three offered traffic classes were used in the simulation: best-effort, elastic and streaming. Each of these traffic classes is mapped for proper DiffServ service classes: best effort to BE, elastic to AF, streaming to EF. The class selected from these services follows directly from recommendation [2] [21]. Packet lengths for these classes were as follows:  $L_{BE}=1500B$ ,  $L_{AF}=500B$ ,  $L_{EF}=160B$ . Buffer's lengths were set to:  $B_{BE}=50$ ,  $B_{AF}=10$ ,  $B_{EF}=5$ . The simulation was repeated for many traffic proportions between these classes, which are presented in Figure 2. Weights of WFQ algorithm are set to:  $\omega_{AF}=0.4$ ,  $\omega_{BE}=0.6$ .

Simulations for all structures were performed for two traffic types: Poisson and self-similar. For the self-similar traffic type Hurst parameter was equal 0.9 for all traffic classes. This value is the result of analysis of self-similarity traffic type for traffic generated by different applications [4] [15] [16] which may represent traffic classes used in this research.

Simulation time was set to 3600s and was repeated for minimizing confidence intervals for  $1-\alpha=0.95$ . For many simulations points disjoint of the confidence intervals were obtained between results for Poisson and self-similar traffic type.

Table I presents comparison of results in a summarized form. This table contains comparison between Poisson traffic type (PS) and self-similarity (SS) traffic type for four structures, two routing algorithm, for largest and lowest EF quota, for largest and lowest AF quota and for any BE quota. Largest EF quota means the largest quota of EF traffic class offered to the network from all quotas at the constant of BE quota, similarly lowest EF quota means the lowest quota of EF traffic class offered to the network from all quotas at the constant of BE quota. Largest and lowest AF quota has similar meaning, but for AF traffic class.

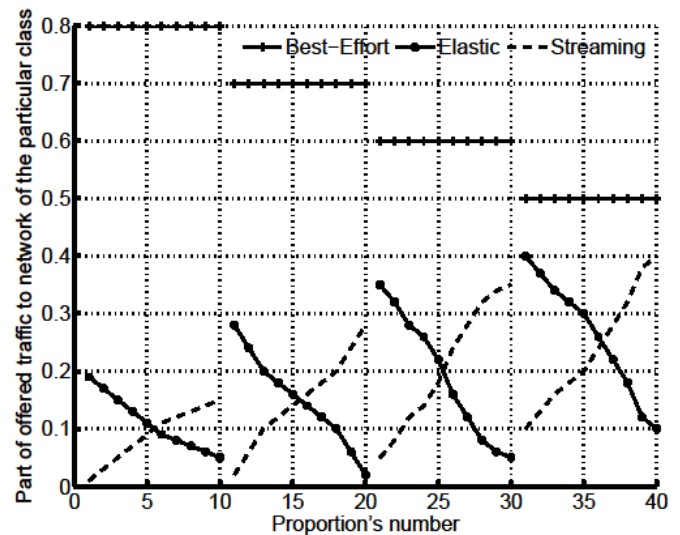

Fig. 2. Combine proportions of traffic classes offered to the network.

TABLE I  
SUMMARY RESULTS COMPARISON

Network Structures					
Name	SUN	NEW YORK	TA1	NORWEY	
Nodes	14	16	24	27	
Links	21	49	55	51	
Density	1.5	3.06	1.29	1.89	
Routing Algorithm: OSPF, traffic class: streaming					
BE quota	EF quota	Greater Performance for traffic type			
80%	Lowest	PS	-	SS	-
	Largest	SS	SS	SS	SS
50%	Lowest	SS	SS	SS	SS
	Largest	SS	SS	SS	SS
Routing Algorithm: DUMBRA, traffic class: streaming					
BE quota	EF quota	Greater Performance for traffic type			
80%	Lowest	PS	-	-	PS
	Largest	PS	SS	SS	-
50%	Lowest	SS	-	SS	SS
	Largest	SS	SS	-	SS
Routing Algorithm: OSPF, traffic class: elastic					
BE quota	EF quota	Greater Performance for traffic type			
80%	Lowest	PS	-	SS	-
	Largest	PS	-	SS	SS
50%	Lowest	-	-	SS	-
	Largest	-	SS	SS	SS
Routing Algorithm: DUMBRA, traffic class: elastic					
BE quota	EF quota	Greater Performance for traffic type			
80%	Lowest	PS	-	-	-
	Largest	PS	SS	-	-
50%	Lowest	-	-	-	PS
	Largest	-	SS	-	SS

The first's rows of the Table I contain short description of network structures. Next, result for four cases are presented: OSPF [17] algorithm and streaming traffic, DUMBRA [14] algorithm and streaming traffic, OSPF algorithm and elastic

traffic, DUMBRA algorithm and elastic traffic. For each of these four cases results for two BE quota are presented: 50% and 80%. For each of these two BE quota results for lowest and largest quotas are presented. Each row is described by one traffic class proportion and contains:

- PS if for this traffic class proportion and this network structures network serviced more packets for Poisson traffic type than for self-similar traffic type,
- SS in the opposite case,
- ' ' it mean that confidence intervals between numbers of serviced packets for network with Poisson traffic type and network with self-similar traffic type is not disjoint.

Detailed results are presented for New York and TA1 structures. These structures were selected due to basic differences between these structures. The first one is with the smallest nodes density, the second one is with the greatest nodes density. They demonstrate to be largely different in terms of size. The results were presented in a non-relative measure with confidence intervals. Selected comparison results between PS and SS traffic type were presented separately for streaming and elastic traffic for DUMBRA and OSPF routing algorithm. Some of these results for OSPF algorithm were presented by the authors of this paper in [20].

Figures 3, 4, 5, 6, 7 present results for New York structure. Figure 3 shows results for streaming traffic and OSPF routing algorithm. The basic conclusion is that more packets of self-similar traffic type are serviced by the network than Poisson traffic type. Second thing is that the difference between the number of serviced packets increases with the increasing amount of the offered packets of the streaming class. Figure 4 shows the results of elastic traffic for OSPF routing algorithm. For this traffic class differences between the network that serviced Poisson traffic type and serviced self-similar traffic type is lower than for the streaming traffic class. The difference is significant only for a higher amount of offered traffic of this class. Figure 5 presents results for DUMBRA algorithms for streaming traffic class.

The number of packet serviced by the network with DUMBRA algorithm is higher for self-similar traffic when comparing to Poisson traffic. OSPF routing algorithm follows this trend as well. The relative difference in the number of packet of streaming traffic class serviced by the network between self-similar traffic type and Poisson traffic type is higher for OSPF algorithm than for DUMBRA algorithm.

Figure 6 presents results for DUMBRA algorithms for elastic traffic class. Results and conclusions are very similar to OSPF routing algorithm.

Figure 7 presents results for OSPF routing algorithm for best-effort traffic class.

The one conclusion is that network will be able to transfer more packets of self-similar traffic type vs. Poisson traffic type. We get the same results for other network structures and other routing algorithms.

Figures 8, 9, 10, 11 present results for TA1 structure. Figure 8 shows results for OSPF routing and streaming traffic class. It is seen that the network serviced more packets of streaming traffic class when the traffic type is self-similar then in the case of Poisson traffic type. Similarly to New York structure, with the growing amount of offered traffic there is a greater difference between the numbers of the packet serviced by the network with self-similar traffic type and the network with

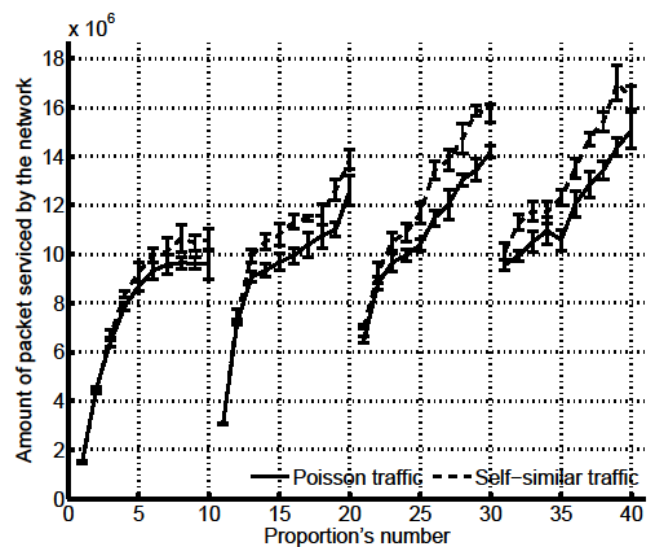

Fig. 3. Results for New York structure and OSPF routing algorithm and streaming traffic class serviced by the network.

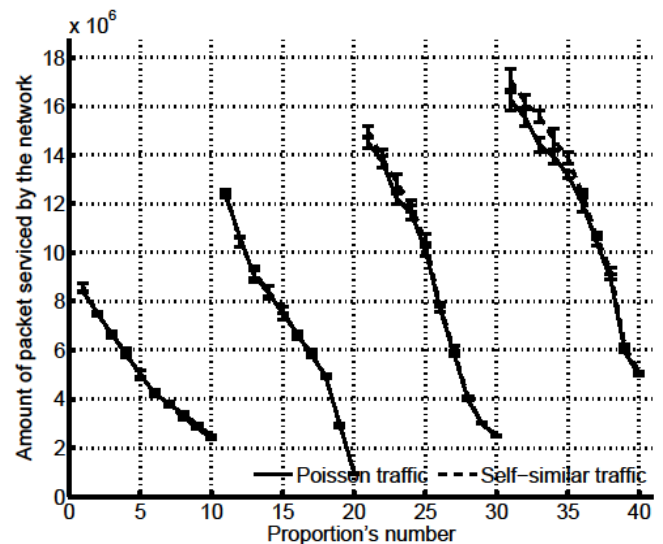

Fig. 4. Results for New York structure and OSPF routing algorithm and elastic traffic class serviced by the network

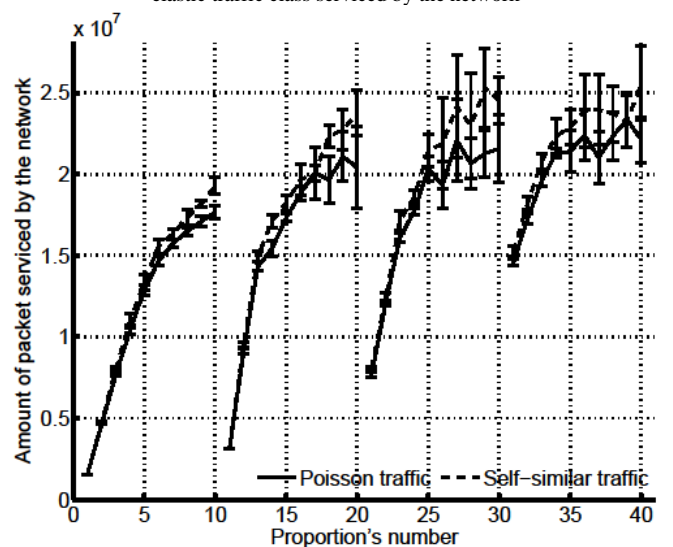

Fig. 5. Results for New York structure and DUMBRA routing algorithm and streaming traffic class serviced by the network.

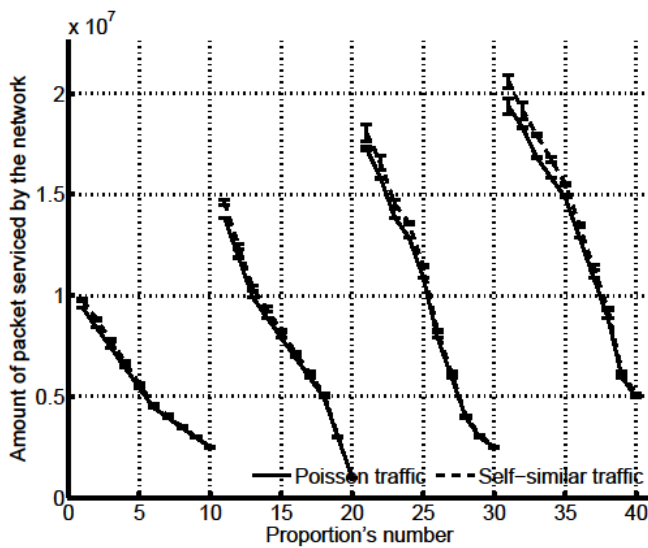

Fig. 6. Results for New York structure and DUMBRA routing algorithm and elastic traffic class serviced by the network.

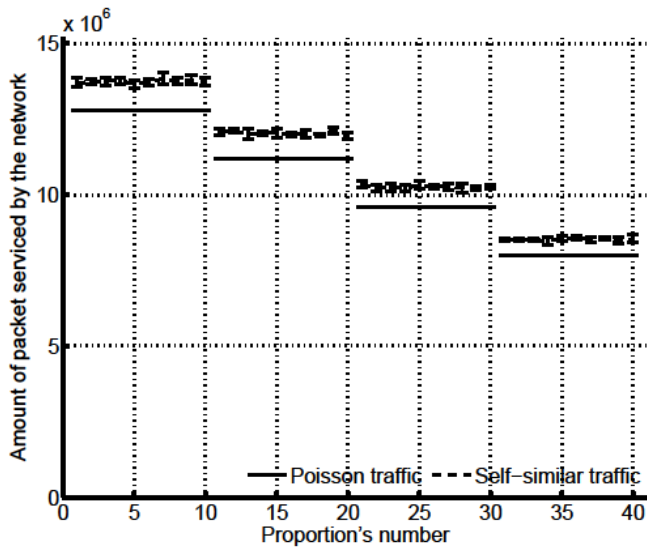

Fig. 7. Results for New York structure and OSPF routing algorithm and best-effort traffic class serviced by the network.

Poisson traffic type. Similar conclusions are true for elastic traffic, for which results are presented in Figure 9. Figures 10 and 11 present results for DUMBRA algorithm for streaming and for elastic traffic. The results are like those above, yet the differences between DUMBRA and OSPF algorithm are particularly clear, i.e.: relative difference of serviced traffic between the network with self-similar traffic type and the Poisson traffic type is less significant for the DUMBRA algorithm.

The summarized analysis of the results in Table I and in Figures 3-11 are presented in followed points and next detailed discussed.

1. Traffic type influences the performance of routing algorithm and depends on the network size:

- a) the performance of a network with Poisson traffic is higher for a small structure,
- b) the performance of a network with self-similar traffic is higher for a large structure.

2. The performance of a network with self-similar traffic is higher than with Poisson traffic if the quota of the traffic class is high.

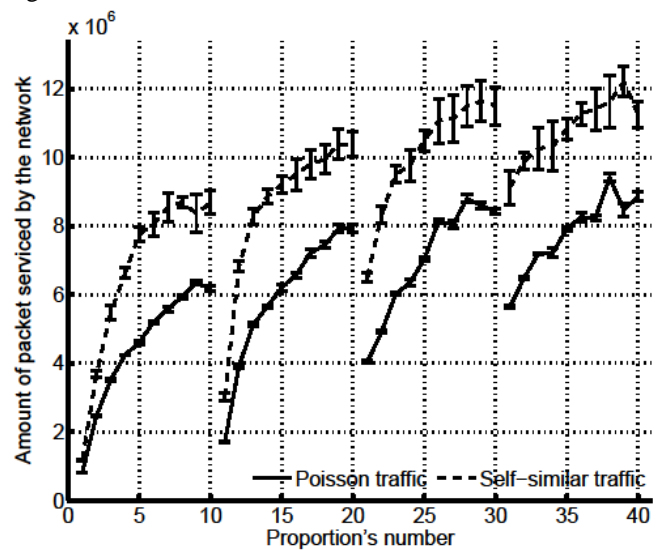

Fig. 8. Results for TA1 structure and OSPF routing algorithm and streaming traffic class serviced by the network.

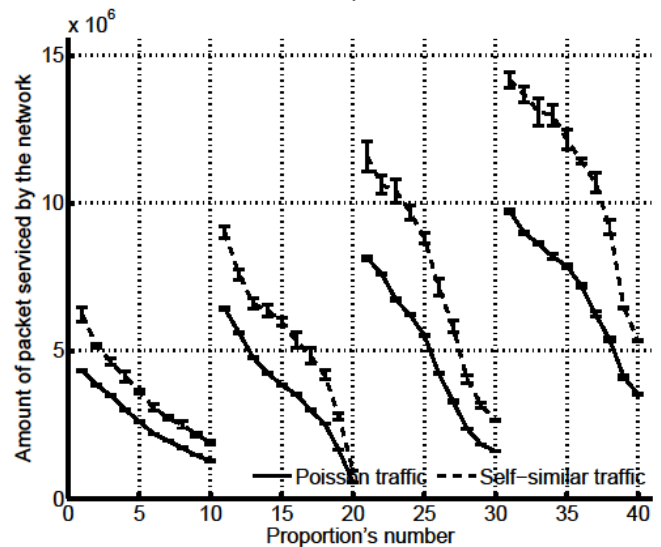

Fig. 9. Results for TA1 structure and OSPF routing algorithm and elastic traffic class serviced by the network.

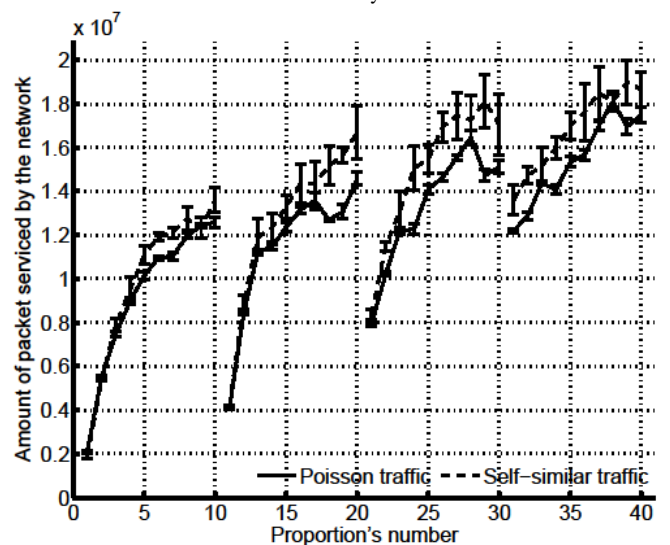

Fig. 10. Results for TA1 structure and DUMBRA routing algorithm and streaming traffic class serviced by the network.

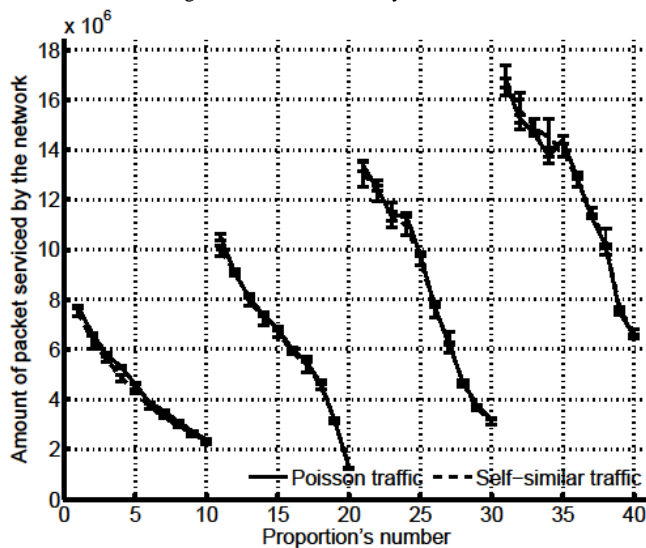

Fig. 11. Results for TA1 structure and DUMBRA routing algorithm and elastic traffic class serviced by the network.

3. The performance of the network with DUMBRA algorithm depends less on the traffic type than the performance of the network with OSPF algorithm.

4. Density of the network structure does not influence on performance of the network between self-similar traffic and Poisson traffic with different routing algorithm. It means that there is no significant impact of density of the network on differences of performance between self-similar and Poisson traffic.

The first point is the effect on the performance analysis for the considered network structures, for different traffic proportions and OSPF and DUMBRA algorithms. The network performance is higher for Poisson traffic type with DUMBRA and with OSPF algorithm and for most traffic proportions. The only exception is for the network structure with a small size, e.g. SUN structure. Network performance is higher for other network structures.

The second point is the effect of performance analysis between different traffic proportions. The network performance is higher for the network with self-similar traffic than the network with Poisson traffic for proportions which include larger amount of streaming traffic.

Another result is the effect of the comparison of results for different structures and different traffic proportions between routing algorithm. Slight differences of network performance are more frequent for the DUMBRA algorithm than for the OSPF algorithm.

The last result was obtained by comparing the results for all scenarios and structures between networks with low density and networks with high density.

All research results confirm that the network performance for all scenarios and best-effort traffic class is higher for self-similar traffic type than for Poisson traffic type.

## V. SUMMARY

In this paper we present the results of research for network performance with two selected routing algorithms and two

traffic types. The research was based on DiffServ architecture, where WFQ and PQ queuing systems are used. Additionally admission control (AC) is used in order to limit traffic serviced by the network. The evaluation was based on the simulation model because the analytical approach is too complicated and possible to resolve only with a large number of simplifications of defined problem.

According to the results presented in Section 4 the influence of traffic type on the performance of the routing algorithm depends on the network size. The network with self-similar traffic has higher performance for larger structures (higher number of nodes), and lower performance for smaller structures. Especially, the performance of the network with self-similar traffic type is higher if the amount of this traffic class is high. The performance of the network with DUMBRA algorithm depends less on the traffic type than the performance of the network with OSPF algorithm. It could mean that DUMBRA algorithm proposed in [14] is more resistant for traffic type change and for traffic type different than the OSPF algorithm.

In the simulation the authors apply some limitations which may influence the results. The exact analysis of the influence of the links capacity is necessary in the future studies. The authors made some initial step forwards [18] yet only for simpler scenarios and for limited number of structures. Based on the gathered results the authors provide conclusions, but owing to the complexity of the problem additional research is needed. Another interesting topic for the future studies can be the influence of self-similar traffic and the value of Hurst parameter. The authors have been unable to research it so far, but they consider these directions as very promising.

## REFERENCES

- [1] M. El-Sayed and J. Jaffe, "A View of Telecommunications Network Evolution", *IEEE Communications Magazine*, vol. 40, pp. 74-81, December 2002.
- [2] S. Blake, D. Black, M. Carlson, E. Davies, Z. Wang, W. Weiss, "An architecture for differentiated services", IETF, RFC 2475, 1998.
- [3] O. I. Sheluhin, M. S. Smolskiy, A. V. Osin, "Self-Similar Processes in Telecommunications", Hoboken: John Wiley & Sons, 2007.
- [4] W. E. Leland, M. S. Taqqu, W. Willinger and D. V. Wilson, "On the self-similar nature of Ethernet traffic (extended version)", *IEEE/ACM Trans. Neww.*, vol. 2, , pp. 1-15, February 1994.
- [5] H. S. Acharya, S. R. Dutta and R. Bhoi, "The Impact of self-similarity Network traffic on quality of services (QoS) of Telecommunication Network", *International Journal of IT Engineering and Applied Sciences Research (IJIEASR)*, vol. 2, pp. 54-60, February 2013.
- [6] M. Guo, S. Jiang, Q. Guan and M. Liu, "QoS provisioning performance of IntServ, DiffServ and DQS with multiclass self-similar traffic", *Transactions on Emerging Telecommunications Technologies*, vol. 24, pp. 600-614, October 2013.
- [7] X. Tan, Y. Zhuo, "Simulation Based Analysis of the Performance of Self similar Traffic", in *Proceedings of 4th International Conference on Computer Science & Education*, Naning, 2009, pp. 312-316.
- [8] M. Pioro, D. Medhi, "Routing, Flow, and Capacity Design in Communication and Computer Networks", San Francisco: Elsevier Inc., 2004.
- [9] N. Likhhanov, B. Tsybakov, N. Georganas, "Analysis of an ATM buffer with self-similar ("fractal") input traffic", in *Proceedings of Fourteenth Annual Joint Conference of the IEEE Computer and Communications Societies. Bringing Information to People*, Boston, vol.3, 1995, pp. 985 - 992.
- [10] OMNeT++, <http://www.omnetpp.org/>, 15.03.2012.
- [11] M. Czarkowski, S. Kaczmarek, "Simulation Model for Evaluation QoS Dynamic Routing", in *Proceedings of ISAT Conference*, Wroclaw, 2009, pp. 255-264.

- [12] ITU-T, "Network performance objectives for IP-based services", Y.1541, February 2006.
- [13] sndlib, <http://www.sndlib.zib.de/>, 01.06.2012.
- [14] M. Czarkowski, S. Kaczmarek, "Dynamic Unattended Measurement Based Routing Algorithm for DiffServ Architecture", in *Proceedings of Telecommunications Network Strategy and Planning Symposium (NETWORKS)*, Warsaw, 2010, pp. 1- 6.
- [15] N. Blefari-Melazzi, "A simple and illustrative analytical model for the performance analysis of queuing systems loaded with mpeg streams", *European Transactions on Telecommunications*, vol. 13, pp. 221-236, May-June 2002.
- [16] T. D. Dang, B. Sonkoly, S. Molnar, "Fractal analysis and modeling of VoIP traffic", in *Proceedings of Telecommunications Network Strategy and Planning Symposium (NETWORKS)*, Vienna, 2004, pp. 123-130.
- [17] J. T. Moy, "OSPF Anatomy of an Internet Routing Protocol", Harlow, England: Addison-Wesley, 2001.
- [18] M. Czarkowski, S. Kaczmarek, M. Wolff, "Traffic Type Influence on QoS Network Performance of Streaming Traffic Class", in *Information Systems Architecture and Technology: Network Architecture and Applications*, Wroclaw, 2013, pp. 63-72.
- [19] M. Czarkowski, S. Kaczmarek, "Simulation model for evaluation of packet sequence changed order of stream in DiffServ network", in *Proceedings of Poznan Workshop of Telecommunication*, Poznan, 2008, pp. 30-34.
- [20] M. Czarkowski, S. Kaczmarek, M. Wolff, "Traffic Type Influence on Performance of OSPF QoS Routing", *Journal of Telecommunications and Information Technology*, vol. 3, pp. 19-28, 2013.
- [21] K. Nichols, S. Blake, F. Baker, D. Black, "Definition of the Differentiated Services Field (DS Field) in the IPv4 and IPv6 Headers", IETF, RFC 2474, 1998.

