

Bartosz BASTIAN\*, Rafał GAWARKIEWICZ\*\*, Michał WASILCZUK\*\*\*

## THE INFLUENCE OF HOUSING ARRANGEMENT AND INTERFERENCE ON PRELOAD AND THEORETICAL LIFETIME OF A SYSTEM OF TAPER ROLLER BEARINGS OF A HIGH SPEED SHAFT OF A WIND TURBINE GEARBOX

### WPLYW WARUNKÓW ZABUDOWY I PASOWANIA NA NAPIĘCIE WSTĘPNE I OBLICZENIOWĄ TRWAŁOŚĆ ZESPOŁU ŁOŻYSK STOŻKOWYCH WAŁU SZYBKOOBROTOWEGO PRZEKŁADNI TURBINY WIATROWEJ

**Key words:** wind turbine gearbox, taper roller bearings, preload, bearing durability.

**Abstract** A system of two taper roller bearings can carry loads with a high ratio of axial load to radial load. Such a system was proposed for a wind turbine gearbox following the poor durability of original bearing design with the aim of increasing durability. Because of size limits, a proposed system is composed of two different taper roller bearings. Standard manufacturers' catalogues do not provide information on recommended preload or clearance conditions or the durability as a function of pre-load. That was the reason why durability was calculated on the basis of software provided by one of the manufacturers. The analysis presented in the paper shows the relationship between bearing fits, preload values, and the theoretical durability of the bearing.

**Słowa kluczowe:** przekładnia turbiny wiatrowej, łożyska stożkowe, napięcie wstępne, trwałość łożysk.

**Streszczenie** Zastosowanie zespołu łożysk stożkowych napiętych wstępnie pozwala przenosić obciążenia charakteryzujące się wysokim stosunkiem siły osiowej do siły promieniowej. Rozwiązanie wykorzystujące taki układ zaproponowano do przekładni turbiny wiatrowej w celu poprawy trwałości łożyskowania. Ze względu na ograniczenia gabarytowe jak i warunki obciążenia, zaproponowano układ dwóch różnych łożysk stożkowych. Katalogi producentów łożysk nie przedstawiają metod obliczeniowych trwałości takich zespołów. Trwałość zespołu łożyskowego została obliczona z wykorzystaniem oprogramowania dostarczonego przez producenta łożysk zgodnie z normą ISO/TS 16281:2008. W pracy przedstawiono analizę wzajemnych zależności między pasowaniem łożysk oraz wstępnym luzem osiowym między łożyskami układu a roboczym napięciem wstępnym oraz obliczeniową trwałością.

## INTRODUCTION

According to the data presented in **Fig. 1** (1), the most common wind turbine gearbox failures are those of the third-high-speed (HS) stage, being responsible for 64% of all failure cases (1).

The consequences of gearbox failures are very expensive, and extensive studies are carried out aimed at solving the existing problem.

The authors analysed the bearing failures of a 1.5 MW wind turbine with frequent HSS bearing system failures (2). As a result, an alternative bearing system was proposed (**Fig. 2**) (3). The system of two taper roller bearings with an appropriate pre-load is hoped to be a remedy against sliding of roller elements, often reported as one of important reasons of premature bearing failures (4).

\* Doctoral studies, Gdańsk University of Technology, Faculty of Mechanical Engineering, ul. Narutowicza 11/12, 80-233 Gdańsk, Poland, e-mail: barbasti@pg.gda.pl.

\*\* Gdańsk University of Technology, Faculty of Mechanical Engineering, ul. Narutowicza 11/12, 80-233 Gdańsk, Poland, e-mail: gawar@pg.gda.pl.

\*\*\* Gdańsk University of Technology, Faculty of Mechanical Engineering, ul. Narutowicza 11/12, 80-233 Gdańsk, Poland, e-mail: mwasilcz@pg.gda.pl.

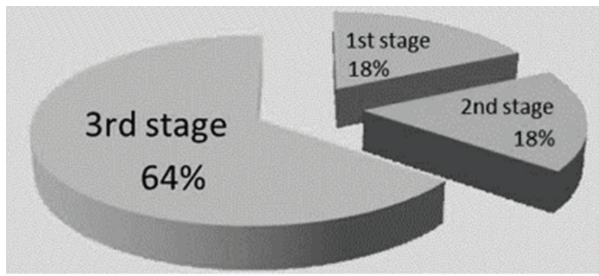

Fig. 1. Failure rate of 3 MW PL-PL-PA gearbox (1)

Rys. 1. Awaryjność przekładni 3 MW PL-PL-PA turbin wiatrowych (1)

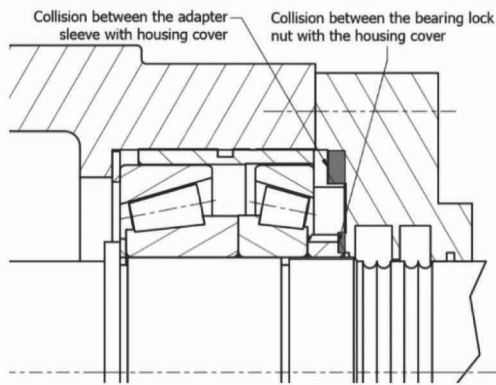

Fig. 2. The proposal of modernization of bearing system with utilization of tapered roller bearings (3)

Rys. 2. Propozycja modernizacji węzła łożyskowego wykorzystująca zespół łożysk stożkowych (3)

Because of space limitations and the requirement of minimizing necessary modifications of other parts of the gearbox, the proposed system utilizes two different roller element bearings. In such a system, specifying an optimum value of operational clearance is crucial, as shown qualitatively in the graphs provided by bearing manufacturers (Fig. 3) (5).

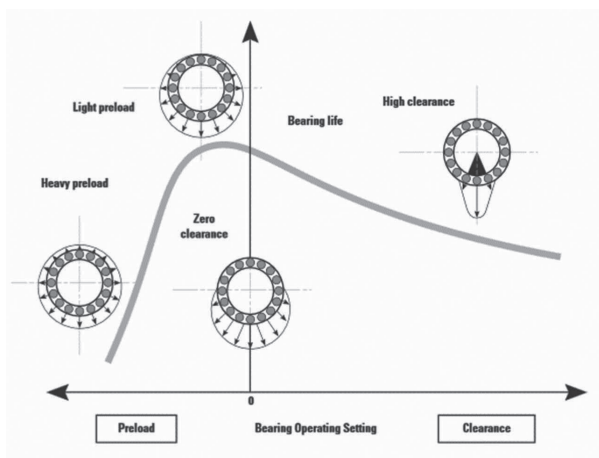

Fig. 3. Bearing life vs. bearing operating setting (5)

Rys. 3. Wpływ napięcia wstępnego na trwałość łożysk (5)

## SYSTEM SETUP

The modelled system was prepared in the BEARINX online Shaft Calculation tool (5). The program was made available to Gdansk University of Technology by the Shaeffler Group for academic purposes. The application performs calculations based on ISO/TS 16281:2008. The method accounts for load distribution between separate rolling elements with the consideration of tilting and misalignment of bearing raceways. The result of calculation contains, inter alia, the values of life rating, load distribution of rolling elements, loads to which the bearings are subjected, equivalent dynamic load, and values of displacements of bearings.

The model (Fig. 4) represents the shaft geometry of the high speed shaft of a 1.5 MW wind turbine. The shaft is supported on two sides by bearings. On the left-hand side, there is NU-230 cylindrical roller bearing, and the system of two tapered roller bearings (32230-A, 30230-A) are mounted on the right side. Inner raceways of the bearings are set to be located rigidly on the shaft, allowing shaft displacement to be transferred to the roller-raceway connection. The outer raceways of two bearings are set to be connected to the rigid environment, assuming that the gearbox housing ensures support stiffness. One of the tapered roller bearing's outer raceways is supported with other means, i.e. it is rigidly connected to the additional bushing. The bushing position is restricted with the exception of the axial direction, allowing the creation of the preload by the change of the position of the outer race of the bearing. The displacement is forced by a pressure spring.

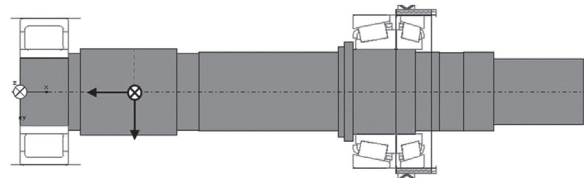

Fig. 4. Model of examined system (6)

Rys. 4. Model badanego układu (6)

During the calculations, the spring preload was a varying input factor, from 0 kN to 25 kN with an increment of 1000 N, and further with a step of 5000 N to 50 kN. Additionally, unstable load conditions, due to changing wind, were considered. On the basis of wind speed data and the power curve for the wind turbine, five working ranges were applied and presented in Table 1.

Table 1. Impact of wind speed on wind turbine load (3)

Tabela 1. Wpływ prędkości wiatru na obciążenie turbiny (3)

	Wind speed [m/s]	Turbine output	Percentage of time [%]
Load case 1	over 11	100%	10
Load case 2	10- 11	75%	11
Load case 3	7-10	50%	29
Load case 4	4-7	25%	32
Load case 5	0-4	0% – turbine stopped	18

**RESULTS**

Performed calculations provided thorough information about system behaviour under given conditions. The results concerning roller-raceway contact were investigated.

The first limiting condition when selecting the proper preload was the minimum radial load. While the bearing load exceeds a threshold value, the bearing operation without slippage is ensured. The value of minimal radial load is given by bearing manufacturer as  $\frac{P}{C_r} > 0.02$  (7). With the use of formula (7) and load capacity of 32230-A and 30230-A bearings, we can evaluate the minimum equivalent dynamic bearing load of 14.8 kN and 9.3 kN, respectively for each of the bearings. The results of equivalent dynamic load evaluated for the 32230 bearing as a function of preload considered as axial load are shown in Fig. 5. Results for the 32230-A bearing show that, in the cases of higher power output (over 50%), regardless of spring preload, the minimum radial load condition is fulfilled. Load Case 5 is represented in the graph by 0%, corresponding to the machine downtime due to insufficient wind speed. This case is not taken into consideration for the assumption of preload values, as fatigue wear does not occur in this situation. Therefore, the value of 5 kN assumed as the minimum required preload is based on Load Case 4 (25%). In the case of the 30230-A bearing, differences between the results of subsequent load cases are insignificant, since the preload force that generates the axial load of this bearing is independent from the load case. The cut-off point when the condition of minimum equivalent load is fulfilled can be assumed as 9 kN. This value determines the final value of the required preload.

Further analysis of the system was focused on reference life rating values (Fig. 6). The nominal life

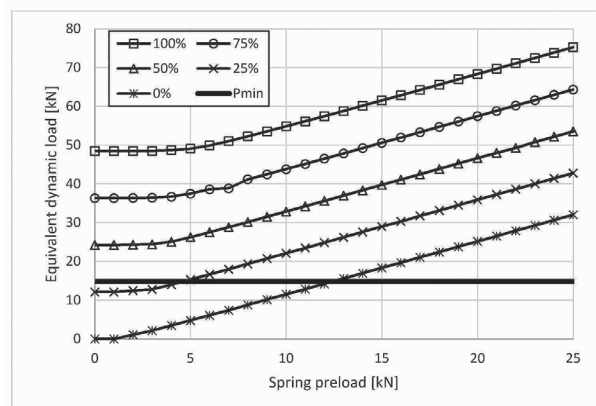
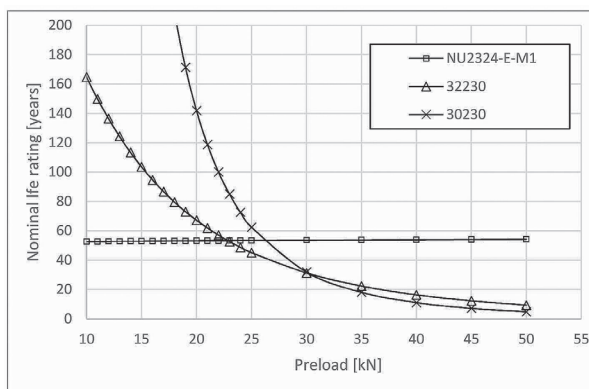

**Fig. 5. Equivalent dynamic load of 32230-A bearing in different turbine power output**

Rys. 5. Obciążenie zastępcze łożyska 32230-A, w różnych stanach obciążenia turbiny

rating of the cylindrical roller bearing is constant regardless of the preload and has a theoretical value of approximately 52 years.

The impact of increasing preload is visible on life rating results of tapered roller bearings. For the required 9 kN of preload, the bearings have very high life rating values, exceeding several times the value of life rating for cylindrical roller bearing. Preload in this system acts as an additional axial force that needs to be carried by the bearings. It is significant that the life rating of both tapered roller bearings decreases with increasing axial preload. The situation where the rating is lower than that of existing cylindrical roller bearings is undesirable. The preload values corresponding to this situation are 22 and 25 kN, because it is visible in Fig. 6. This indicates the need of using a preload lower than 22 kN.



**Fig. 6. Nominal reference life rating of bearings in the system (acc. to ISO/TS 16281:2008)**

Rys. 6. Trwałość łożysk zgodnie z ISO/TS 16281:2008

The need of using the initial preload can also be observed in the distribution of loads between rollers (Fig. 7). According to the literature (4), the use of preloaded tapered roller bearings allows the simultaneous load of the rows of rollers of both bearings under external axial load. Load distributions of both tapered roller bearings without preload, and in two cases of 5 kN and 22 kN preload, are presented in the figure. Bearing 32230 is constantly subjected to external axial force and all rollers of this bearing are engaged with the raceway. The shapes of the graphs are similar between cases with the exception of the values. It is different in case of the 30230 bearing, where, without preload the rollers are not loaded and may be prone to sliding with respect raceways during operation. At a higher preload, a more uniform distribution, advantageous for bearing life, can be observed. For 5 kN preload, the situation changes, most of the rollers become engaged with the raceways, and for the higher preload, similarly to the other bearing, all elements support the bearing.

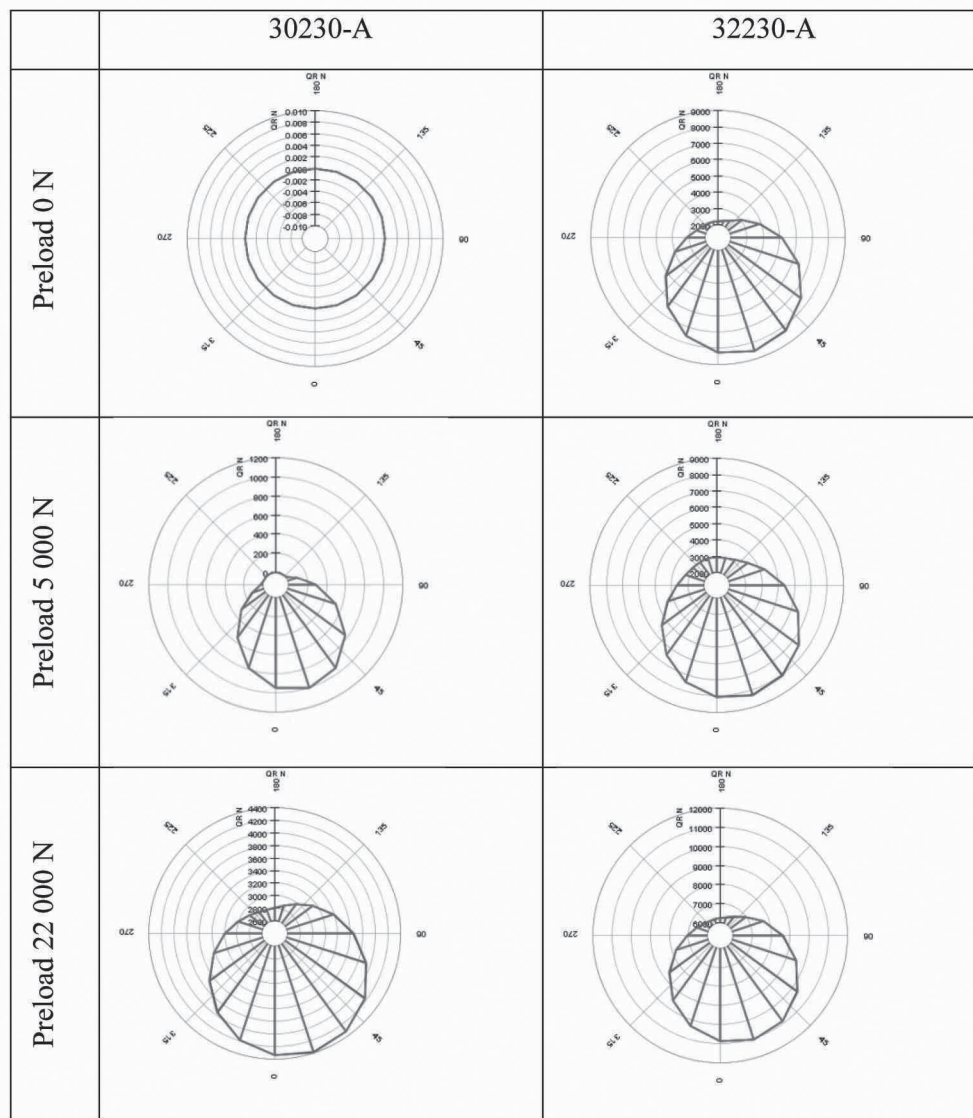

**Fig. 7. Load distribution between rollers of tapered roller bearings**

Rys. 7. Rozkład obciążeń rolek łożysk stożkowych

### PRELOAD APPLICATION IN THE SYSTEM

A general recommendation, according to catalogues in a system of two taper bearings in which, due to a special ring installed between bearings, an initial axial clearance is provided (A at **Fig. 8**). After mounting the bearings with an interference fit, this provides an optimum operating condition. In the case of two bearing of different sizes, in a face to face arrangement, there are no specific guidelines for setting the clearance value, and it was chosen as equal to the value for matched pair of similar size, i.e. 280–330  $\mu\text{m}$  (7).

During the mounting of the bearings, in the interference between the bearing bore and the shaft, the inner rings of bearings expand, decreasing the clearance and further generating preload, as shown in **Fig. 9**.

The radial expansion of the inner ring due to fitting is equal to  $\Delta d = 0.8 U$ , (7) where  $U$  is the value of theoretical radial interference of the fitted parts.

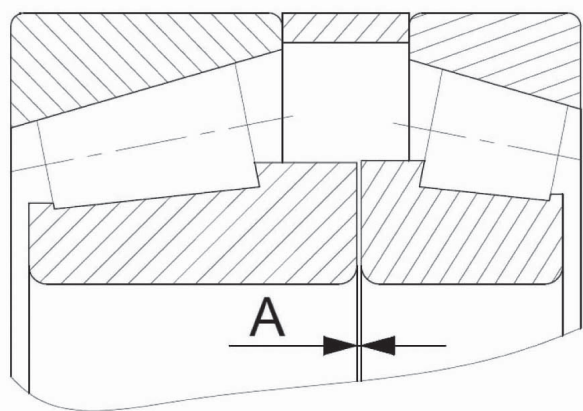

**Fig. 8. Internal axial clearance (A) in a system of tapered roller bearings**

Rys. 8. Wewnętrzny luz osiowy (A) zespołu łożysk stożkowych

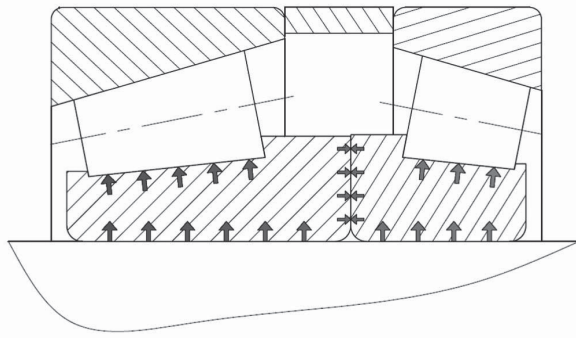

**Fig. 9. Expansion of inner rings due to fitting**  
 Rys. 9. Rozszerzanie się pierścienia wewnętrznego łożyska z powodu pasowania

The ratio between axial ( $s_a$ ) and radial ( $s_r$ ) clearance for tapered roller bearings is given by manufacturer (7):

$$\frac{s_a}{s_r} = 4.6 \cdot Y_0$$

For both tapered roller bearings used in the study, the value of  $Y_0$  factor is equal to 1.38, yielding the ratio of  $s_a/s_r = 6.348$ . With the assumption of the expansion of the bearing ring equal to the reduction of the radial clearance ( $s_r = \Delta d$ ), and equal expansion between bearings ( $s_{r1} = s_{r2}$ ), the formula for theoretical needed interference can be presented as follows:

$$U = \frac{s_a / 2}{0.8 \cdot 4.6 \cdot Y_0}$$

The value  $S_a$  is based on the calculations and is assumed as the sum of displacements of the bearings. Therefore, the relationship between radial interference (U) and the achievable preload value was calculated, based on the values of bearing displacements, for extreme values of internal clearance  $U_{280\mu m}$  and  $U_{330\mu m}$  and is presented in **Fig. 10**.

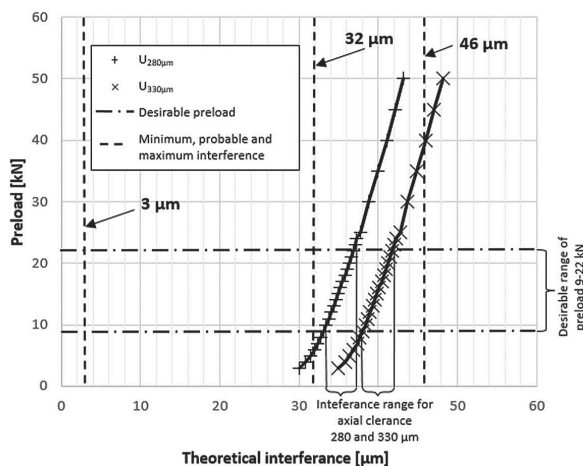

**Fig. 10. Preload in function of theoretical radial interference for values 280 μm and 330 μm of internal clearance of bearings**

Rys. 10. Wartość napięcia wstępnego w zależności od teoretycznego wcisku dla wartości wstępnego luzu osiowego o wartościach 280 oraz 330 μm

Radial interference necessary for the removal of the internal axial clearance (A) is equal to 27.6 and 32.5 μm, respectively, for 280 μm and 330 μm values of the clearance. Therefore, the preload does not exist below these values of interference. The tolerance of the shaft can be specified on the basis of the manufacturer’s recommendations as k5 fitting, for lightly loaded bearing ( $C/P < 10$ ). The use of such tolerance for the shaft diameter results in interference values range of 3–46 μm and the probable interference of 32 μm, shown as vertical lines in **Fig. 10**. For the first margin of the range of the interference (3 μm), no preload will be obtained. Depending on the size of the initial clearance, the probable interference (32 μm) will result in an insufficient preload for smaller axial clearance and no working preload for the case of 330 μm clearance. For the case with minimum bearing bore diameter and maximum size of the shaft (interference equal to 46 μm), the preload will exceed 40 kN for the initial axial clearance of 330 μm, and a preload over 50 kN, which is outside of the range, will be obtained for a smaller initial axial clearance of 280 μm. The desirable interference ranges are mutually exclusive for the extreme internal clearance values. For 280 μm axial clearance, the interference should be between 33.1–36.8 μm and for 330 μm within the range 38–41.7 μm. A summary of the bearings operating conditions under given interference is presented in **Table 2**.

**Table 2. Evaluation of preload amount depending on the real interference for 280 μm and 330 μm initial axial clearance**

Tabela 2. Ocena stanu napięcia wstępnego w zależności od wcisku dla skrajnych przypadków luzu osiowego (280 i 330 μm)

	Over	Incl.	280 μm	330 μm
Range of radial interference [μm]	3	27.6	No preload – risk of roller sliding	No preload – risk of roller sliding
	27.6	32.5	Insufficient preload – risk of roller sliding	Insufficient preload – risk of roller slippage
	32.5	33.1		
	33.1	36.8	Proper preload	Proper preload
	36.8	38	Assumed preload exceeded – danger of low life rating value with increasing interference.	
	38	42.7		
	42.7	46		Assumed preload exceeded – danger of low life rating value with increasing interference

This shows that precise geometrical control of the preload value is impossible in the analysed case. For more accurate regulation of the preload value, it might be more feasible to use force generated preload in the

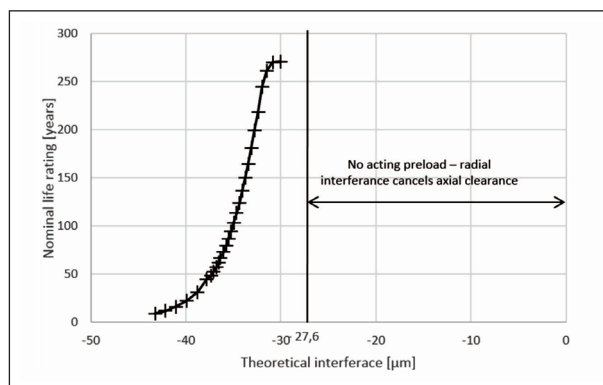

**Fig. 11. Nominal life rating in function of interference for 32230 bearing for 280  $\mu\text{m}$  initial clearance**

Rys. 11. Trwałość łożyska 32230 w funkcji wcisku między łożyskiem a wałem dla 280  $\mu\text{m}$  wstępnego luzu osiowego

form of springs or threads instead of geometrical control suggested by the bearing manufacturer. This could regulate the real amount of preload more accurately, avoiding the problem of too large tolerances in the shaft-bearing connection.

With the correlation between the preload and the radial interference, the relationship between life rating and the interference can be obtained. **Figure 11** shows the relationship for 280  $\mu\text{m}$  initial axial clearance (A). Between 0 and 27.6  $\mu\text{m}$  interference, the interference

reduces the axial clearance, over that value, excessive interference starts to generate preload. Therefore, the shape of the curve can be correlated with the left arm of the graph in **Fig. 3**.

## CONCLUSIONS

Calculations show that with the increase of the preload, the rating life of the bearing system of the high-speed shaft in wind turbine can significantly change. The increase of preload results in the decrease of life rating values. Tapered roller bearings, subjected to low values of initial preload, present high values of calculated rating life, exceeding several times the rating life of the cylindrical roller bearing used in the system. The calculations do take into consideration the problem of insufficient load of the bearings, which is a determining factor while choosing preload. The determination of proper preload allows one to calculate proper fitting for the system, allowing preferable operating conditions. The proper radial interference value of the joint can be theoretically calculated, but the high sensitivity of tapered roller bearing to radial fit makes it impossible to provide required values of the preload for the whole tolerance field. There might be a necessity of the introduction of a different system of generating preload by springs or thread in order to obtain precise values of desired preload.

## REFERENCES

1. Halse C.: Wind Turbine Drivetrain Development, Romax Technology Inc., USA Wind Technical Center, 2012.
2. Wasilczuk M., Gawarkiewicz R., Libera M., Wasilczuk F., Kinal G.: Bearing systems of wind turbines – maintenance problems (in Polish). *Tribologia 4/2015(4-2015):187–198* · 10/ 2015.
3. Bastian B., Gawarkiewicz R., Wasilczuk M.: Analysis of the possibilities of high speed shaft bearing system durability increase. *Tribologia 3/2016 (3-2016):037–047*.
4. Marks C.S., Matthew B.T.: Bearing selection techniques as applied to mainshaft direct and hybrid drives for wind turbines, Timken Technical Paper, 2009.
5. Timken bearing damage analysis with lubrication reference guide. <http://www.timken.com/ja-jp/products/maintdiag/Documents/5892-Timken-Bearing-Damage-Analysis-with-Lubrication-Reference-Guide.pdf>, 2015.
6. Bearinx-online, [www.bearinx-online.ina.de](http://www.bearinx-online.ina.de).
7. FAG, Rolling Bearings, 2014.

