

Electric shock hazard in circuits with variable-speed drives

S. CZAPP* and J. GUZINSKI

Faculty of Electrical and Control Engineering, Gdańsk University of Technology, 11/12 Narutowicza St., 80-233 Gdańsk, Poland

Abstract. The conventional approach to electrical safety under fault condition in typical power systems considers earth fault currents of sinusoidal waveform and frequency of 50–60 Hz. However, in circuits with variable-speed drives, there is earth fault current flow with harmonics, and these harmonics influence the threshold of ventricular fibrillation. The paper presents earth fault current waveforms in circuits with variable-speed drives without inverter output (motor) filter and with one of the two types of inverter output filters being used. The details of both filters are presented, and the effect of harmonics of earth fault current on ventricular fibrillation is evaluated. Furthermore, the effect of harmonics, which occurs in circuit of variable-speed drive, on the tripping current of residual current devices is presented. Residual current devices may be utilized to ensure protection against direct and indirect contact, but limitations in their proper operation, due to harmonics, may exist. Operational characteristics of a proposed residual current device dedicated to circuits with earth fault current containing harmonics, as in the variable-speed circuits, are presented.

Key words: variable-speed drives, earth fault currents, power electronics converters, protection against electric shock, residual current devices.

1. Introduction

In low-voltage systems, protection against electric shock in case of insulation fault is most often performed with the use of automatic disconnection of supply [1, 2]. As a protection device, an overcurrent or residual current device (RCD¹) is used. In case of insulation fault it is required that the earth fault current is high enough to make tripping a protection device in a specified time indicated in the standard [2]. When residual current device with a rated residual operating current not exceeding 30 mA ($I_{\Delta n} \leq 30$ mA) is installed in the circuit, protection in case of direct contact (extremely dangerous for persons) is ensured as well. Figure 1 presents direct contact and indirect contact in a circuit.

In nowadays power systems, especially industrial low-voltage systems, variable-speed drives are widely used. As in other low-voltage systems, automatic disconnection of supply is used as well. However, as it is concluded in [3–5], these types of circuits are very difficult for evaluating the effectiveness of protection against electric shock. The earth fault current is distorted and waveform shape of this current depends on the point of fault, actual motor speed and inverter PWM switching frequency. Moreover, input and/or output inverter filters can be applied. It is important to underline that inverter output filters (motor filters) can strongly influence the waveform shape of earth fault current.

Taking into account persons safety in circuits with variable-speed drives, it is strongly recommended to recognize the

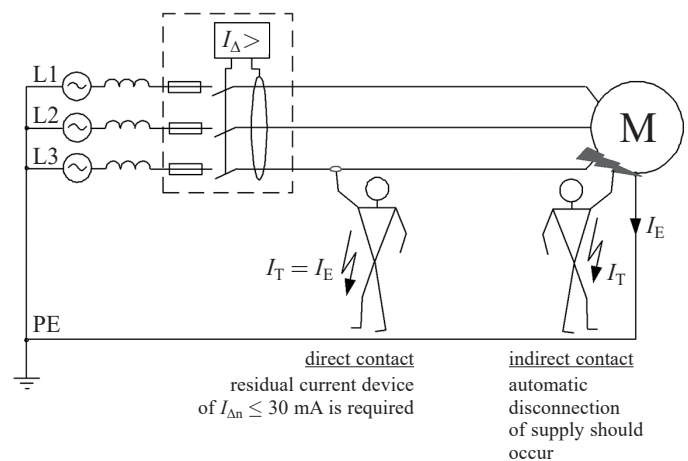

Fig. 1. Direct and indirect contact in a circuit, and requirements to achieve safety; ($I_{\Delta} >$) – residual current device, I_E – earth fault current, I_T – touch current

effect of inverter output filters on earth fault current waveform and evaluate the threshold of ventricular fibrillation in relationship to the arrangement of the variable-speed drive circuit (no filter, type of motor filter). It is also important to recognize behavior of protective devices in such circuits, especially devices dedicated for protection against electric shock. Earth fault current harmonics influence operation of residual current devices in a negative way, and thus the protection against electric shock may be ineffective.

In literature, the above mentioned problems have not been investigated exhaustively. In paper [5] the effect of a single harmonic, especially one of the high order harmonics, on tripping of residual current devices has been analyzed. In conclusion, it has been written that high order harmonics negatively in-

¹In USA and Canada the device is more commonly known as a ground fault circuit interrupter (GFCI)

*e-mail: stanislaw.czapp@pg.edu.pl

Manuscript submitted 2016-12-08, revised 2017-03-07, initially accepted for publication 2017-07-14, published in June 2018.

fluences the tripping threshold of residual current devices. No analysis of current harmonics on a person's heart function is included. The author of the paper [6] analyses electrical safety in installations with residual current devices in general. There is no mention about frequency converters or the effect of harmonics on people and residual current devices.

Paper [7] considers interferences in electrical circuits due to RF transmission, and their effect on residual current devices nuisance tripping. This paper does not focus on the problem of proper detection of harmonics by these devices. Research works [8] and [9] also consider only nuisance tripping of residual current devices. The effect of harmonics on RCDs tripping is conducted in [10]. The conclusions are similar to those presented in [5], but variable-speed drives circuits have not been analyzed. Sinusoidal current of higher frequency and its impact on tripping of residual current devices is presented in [11] – after analysis of the results, it can be said that high frequency waveform, similarly like a distorted current, may influence this tripping negatively. Consequences of multi-frequency current flow through the human body are analyzed in [12]. However, only threshold of perception is considered.

Papers considering variable-speed drives are rather focused on energy efficiency, electromagnetic compatibility, power quality, and effective methods of control of drives [13–17]. After the analysis of many research papers, it may be concluded that the problem of electrical safety in modern circuits with variable-speed drives should be more deeply investigated.

This paper is an extension and continuation of the discussion presented in [18] and focused on the problem of safety omitted in previous papers. The goal of the paper is to evaluate the threshold of ventricular fibrillation and the tripping current of residual current devices in case of fault in variable-speed drive circuit.

2. Structure of variable-speed drive circuit

The widely used voltage inverters are commonly based on fast switching IGBT transistors [13, 14, 19–22]. Due to very short on and off times of the transistors and voltage level of the inverter supply the extremely high dv/dt appears in the circuit. It is reported that high dv/dt in the inverters causes some serious

problems in electric drives [13, 14, 21, 22]. High dv/dt simultaneously with high switching frequency degrade motor bearings rapidly and can generate motor insulation failure as well. The motor efficiency is also decreased. All those effects can quickly cause downtime of a motor and the whole drive. In some applications, where long cable connections are used, the serious problems with electromagnetic compatibility will occur.

To prevent the unwanted effects of frequency converters and to guarantee the electromagnetic compatibility, the passive filters are installed on the inverter output. With proper structure of the filter, the time to the motor bearing failure and insulation degradation significantly increases. That inverter output filters, known also as motor filters, have a few commonly used structures [15–17, 23]:

- LC filters (named also as low pass filters or differential mode filters),
- common mode filters,
- dv/dt filters, and
- hybrid filters which join properties of differential and common mode filters.

The LC filter is a low pass filter with line inductance and a transverse leg with capacitor. A good fitting of LC parameters to motor load and inverter switching frequency assures the nearly sinusoidal shape of motor supply voltages and currents. Due to some probability of resonance appearance, dumping resistors are placed in series with capacitor. Structure of the LC filter is presented in Fig. 2a. The common mode filters limit or completely eliminate the leakage current of the motor flowing through internal parasitic capacitors and motor bearings to the earth. The benefits of dv/dt filters are elimination of voltage wave reflection and motor insulation protection. The dv/dt filter has the same structure as differential mode filter, however, its cut off-frequency is much higher so it results in lower inductances and capacitances of the filter. The disadvantage of dv/dt filter is that the filter has to be fitted with cable length. It is worth to underline that properties of dv/dt filters are also obtained in differential mode filters and in some structures of common mode filters.

The connection of differential and common mode filters gives the hybrid filters which join benefits of both items. An example of hybrid filter structure is presented in Fig. 2b. The L_f , C_f and R_f elements create differential mode filter whereas L_{CM}

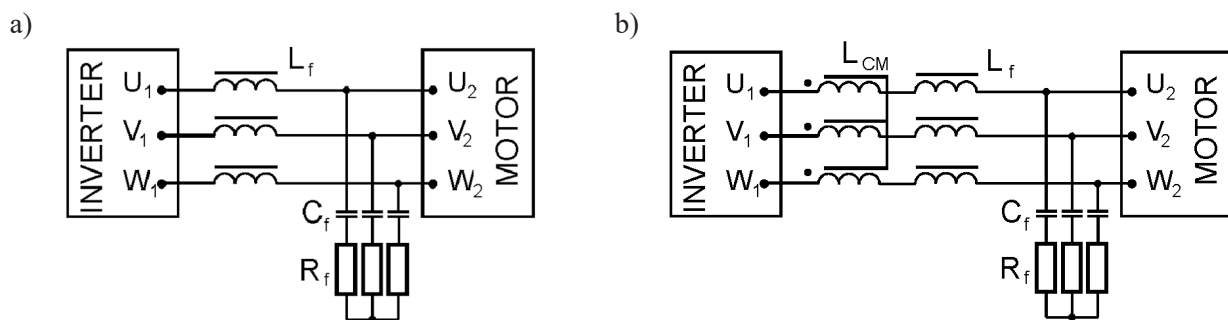

Fig. 2. The structures of the filters used in the investigations: a) LC filter “LCF”: $L_f = 9$ mH, $C_f = 8$ μ F, $R_f = 2.2$ Ω , b) hybrid filter “HF”: $L_{CM} = 14$ mH, $L_f = 5.6$ mH, $C_f = 10$ μ F, $R_f = 1$ Ω

is for common mode operation. It has three symmetrical windings wound on toroidal core. The L_{CM} inductor has negligible inductance for differential mode currents, whereas L_f influence on common mode current is very low.

The analyzed structure of variable-speed drive is presented in Fig. 3 [14, 18]. The low-voltage system is of TN type – neutral point of the source is connected to earth directly and all frames in the installation are connected to the neutral via PE conductor. A frequency converter is of typical type which is used in nowadays industry. It consist of input diode rectifier, high capacitance in intermediate DC circuit and a voltage inverter with IGBT transistors. The motor control principle of the inverter is the widely used $V/f = \text{const}$ algorithm with space vector PWM and 3.3 kHz switching frequency.

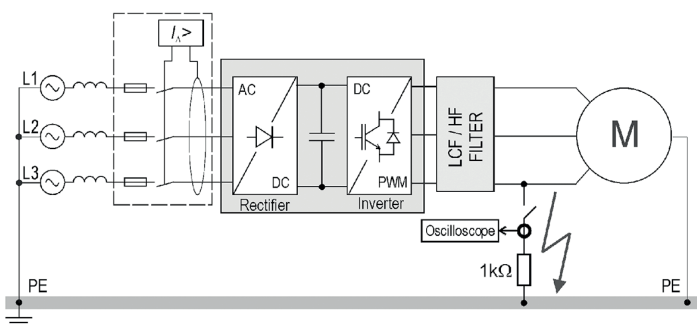

Fig. 3. The structure of the analyzed variable-speed drive circuit [18]

Each of the filters presented in Fig. 2 can be installed on the inverter output. Filters are connected to the inverter with short connections. Longer cable connects filter output and motor terminals. One of the motor supply terminals can be shortened to earth using 1 kΩ resistor. The low inductance resistor simulates resistance of a human body. When a motor terminal is shortened the excited artificial earth fault current is measured using a high frequency current probe type TCP0030 and an oscilloscope type DPO4034. The same testing equipment

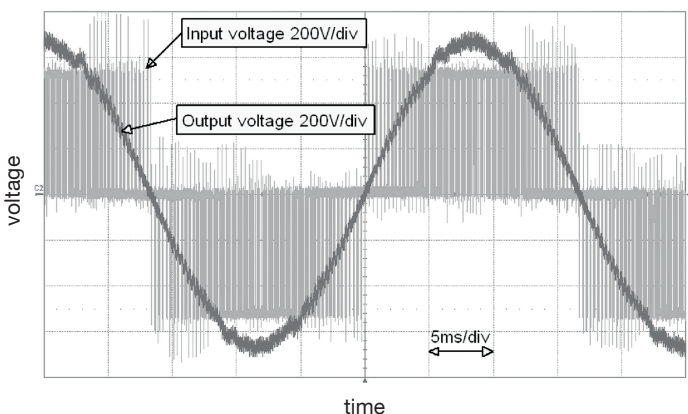

Fig. 4. The waveforms for LCF filter: line-to-line input and output voltage under normal operation – no earth fault, $f_{1\text{har}} = 30 \text{ Hz}$

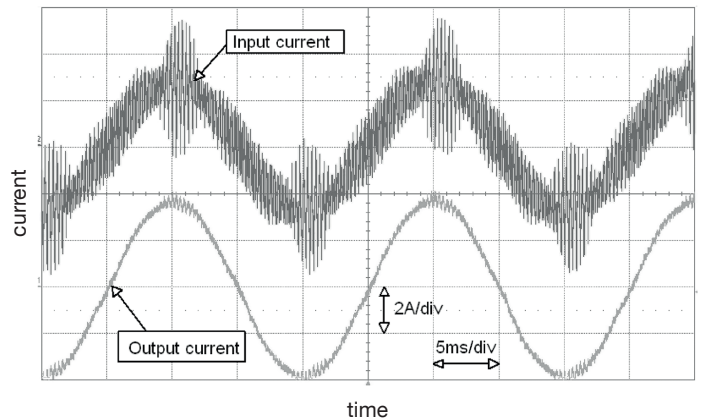

Fig. 5. The waveforms for LCF filter: input current and output current under normal operation – no earth fault, $f_{1\text{har}} = 50 \text{ Hz}$

was used for motor leakage current (PE current) measurement. The voltage differential probe type P5205 was used for measurements as well.

The operation of LCF filter in failure-free case is presented in Fig. 4 and Fig. 5 for differential mode voltages and currents, whereas the common mode voltage waveform is presented in Fig. 6. The common mode voltage (CMV) presented in Fig. 6 was measured between filter neutral point and inverter dc-link

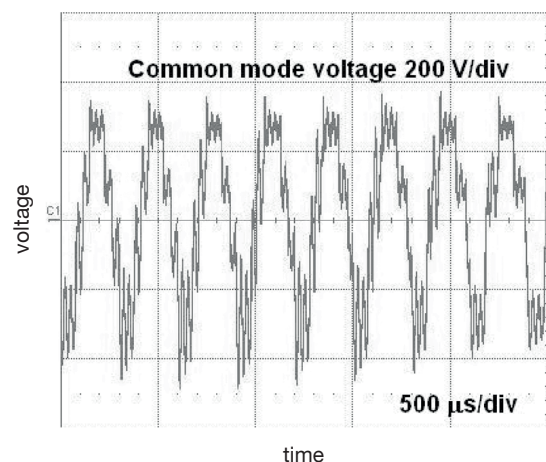

Fig. 6. The waveform of common mode voltage for LCF filter under normal operation – no earth fault, $f_{1\text{har}} = 25 \text{ Hz}$ [18]

middle point. Peak-to-peak voltage is equal to inverter DC voltage (ca. 560 V) and the frequency is equal to inverter switching frequency (3.3 kHz). Due to high dv/dt , CMV is the source for significant to-earth leakage current.

Figure 7 shows an influence of the filters on motor leakage current under normal operation. The highest value of leakage current (measured in PE conductor) occurs in the arrangement without motor filter (Fig. 7a). Peak value of this current exceeds 1 A. Such value may cause nuisance tripping of residual current protective devices. LCF filter (low pass, differential

mode filter) reduces peak value of leakage current, but slightly (Fig. 7b). Strong reduction of this current is observed in the arrangement with HF filter (hybrid, differential & common mode filter) – Fig. 7c.

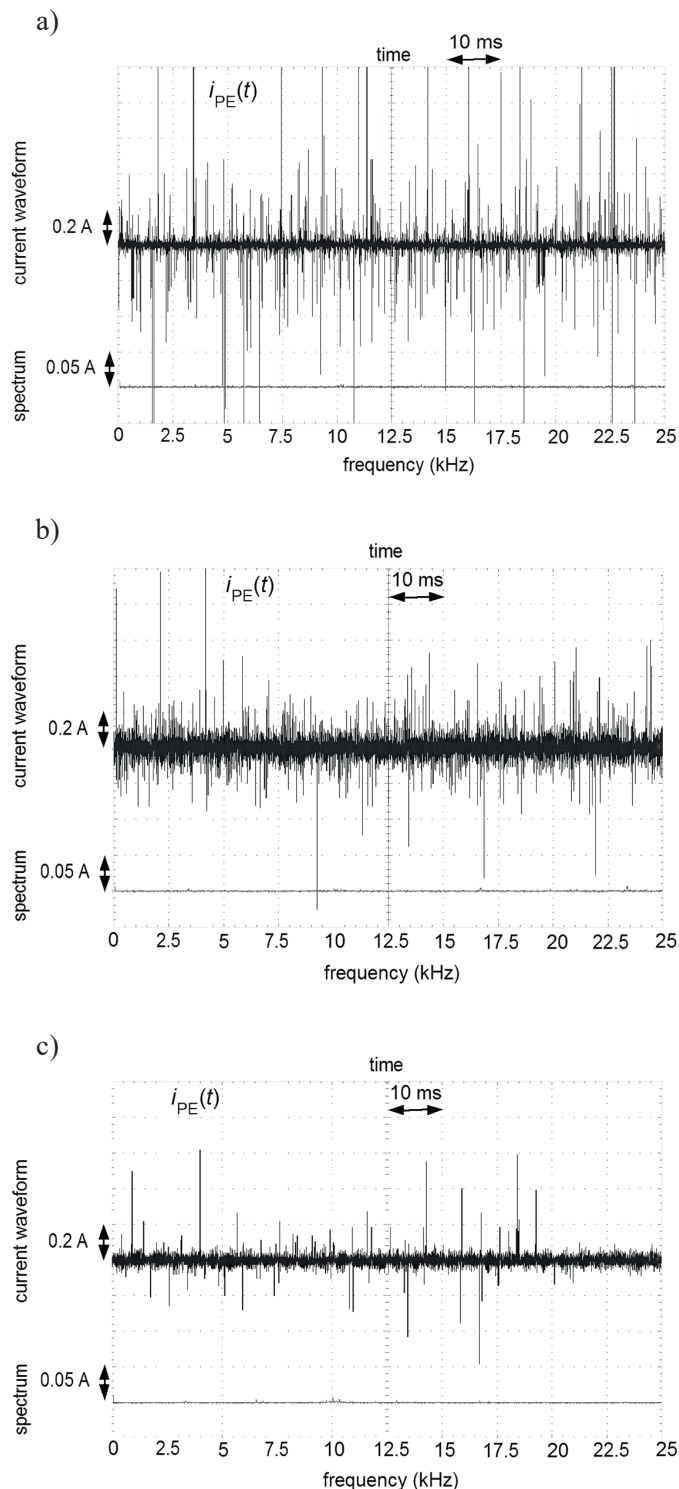

Fig. 7. Current in PE conductor under normal operating conditions $i_{PE}(t)$ and its spectrum in circuit with variable-speed drive; rated motor speed (50 Hz); a) without motor filter, b) with LCF filter, c) with HF filter [18]

3. Earth fault current analysis

In order to evaluate shock hazard in motor circuit, a spectral analysis of the earth fault current was performed [18]. The following variations of the circuit were considered:

- without motor/inverter filter,
- motor filter LCF is applied (low pass, differential mode),
- motor filter HF is applied (hybrid, differential & common mode).

Earth fault current was measured in the structure presented in Fig. 3. The results of the measurement are presented in Fig. 8, Fig. 9 and Fig. 10. The earth fault current is comprised of a low

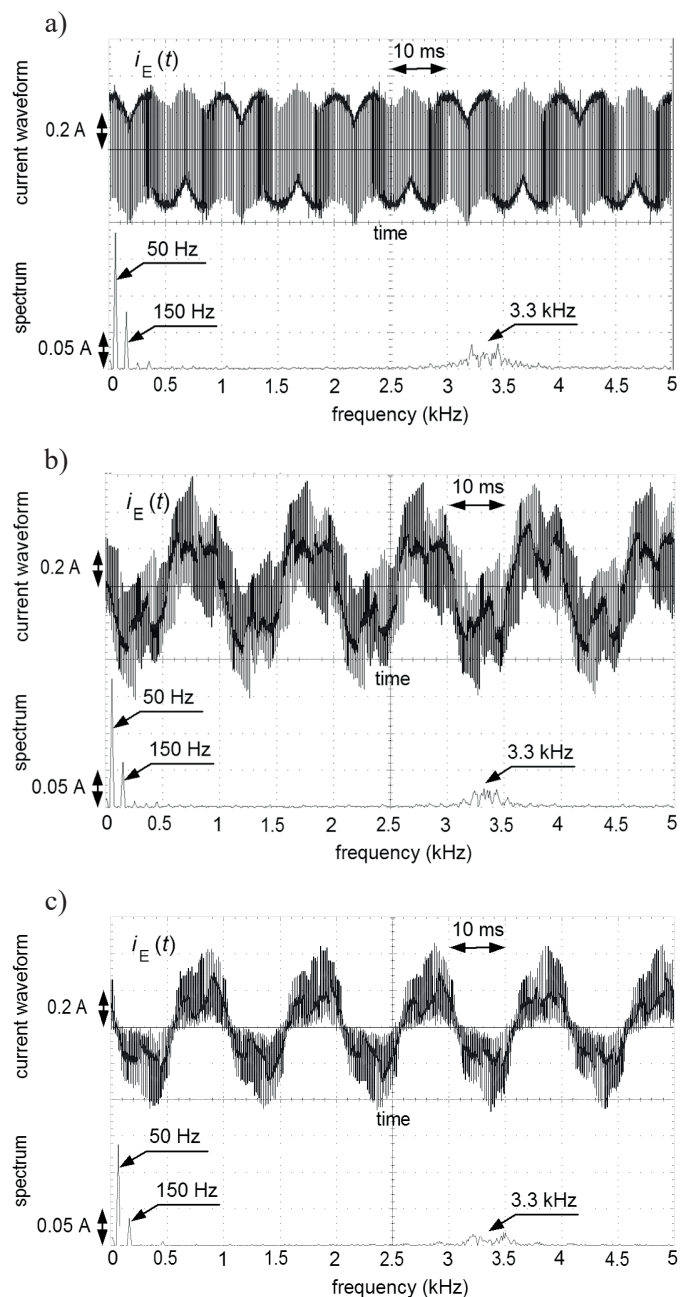

Fig. 8. Earth fault current waveform $i_E(t)$ and its spectrum in circuit with variable-speed drive; motor frequency 50 Hz (rated motor speed); a) without motor filter, b) with LCF filter, c) with HF filter [18]

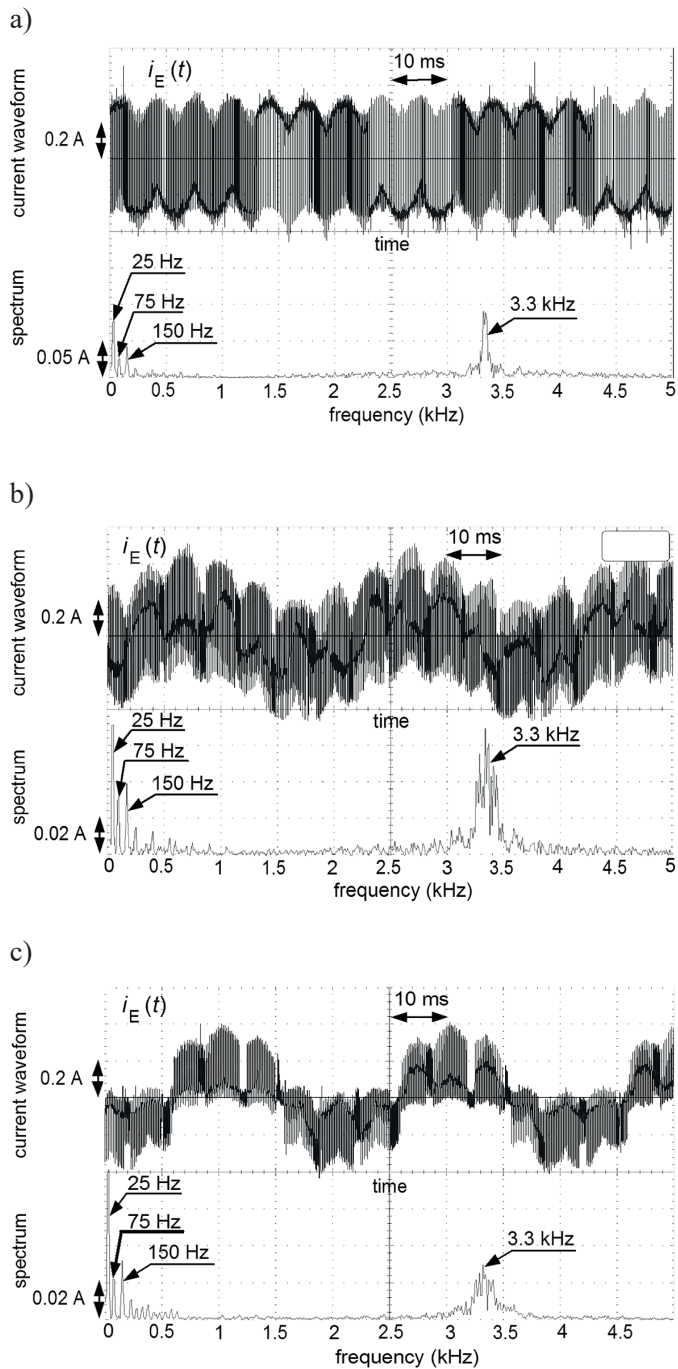

Fig. 9. Earth fault current waveform $i_E(t)$ and its spectrum in circuit with variable-speed drive; motor frequency 25 Hz (50% of the rated motor speed); a) without motor filter, b) with LCF filter, c) with HF filter

frequency component which depends on the desired motor speed, a third harmonic of the low frequency component, a constant 150 Hz component as well as a component at the PWM frequency and its multiple and also its interharmonics. The amplitude of the low frequency component, the third harmonic and the PWM component change as a function of the motor speed and reference frequency. The source of 150 Hz component is the input rectifier of the converter – the 3-phase diode bridge

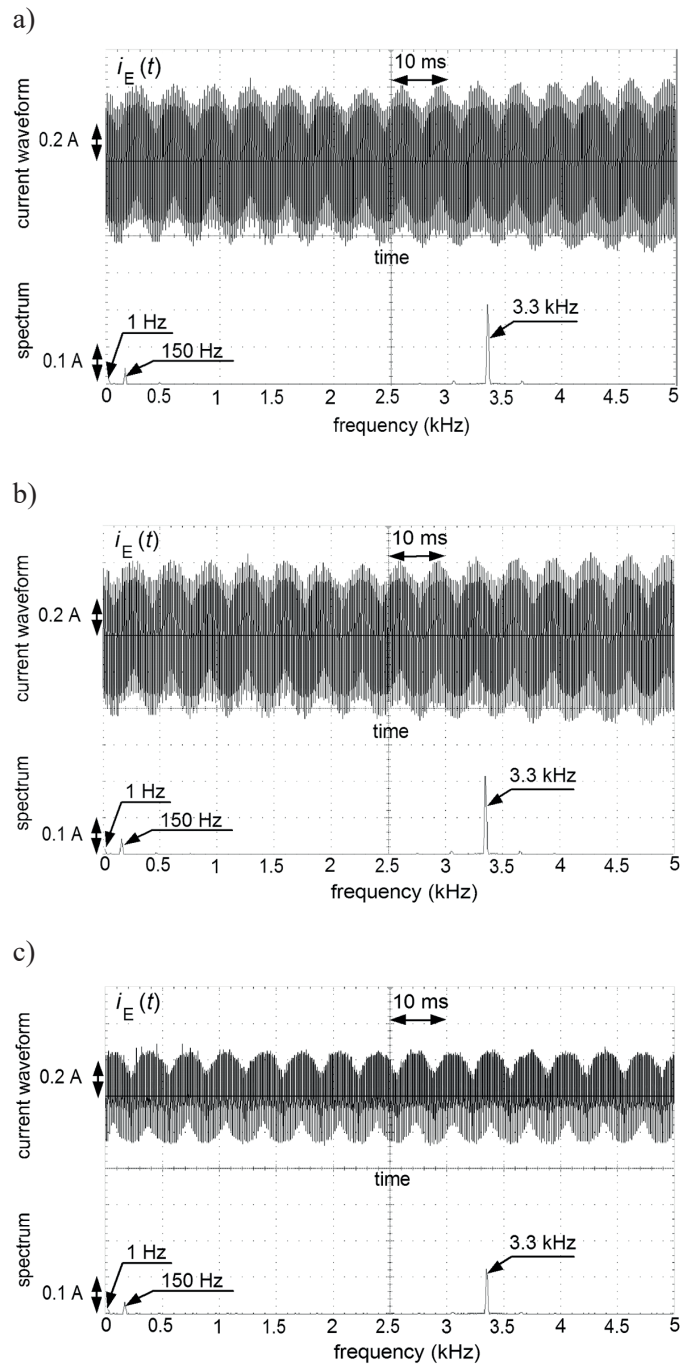

Fig. 10. Earth fault current waveform $i_E(t)$ and its spectrum in circuit with variable-speed drive; motor frequency 1 Hz (extremely low motor speed); a) without motor filter, b) with LCF filter, c) with HF filter [18]

– which is the part of CM circuit [24]. The rectifier diodes are switched with constant frequency related to AC grid supply.

For the 50 Hz operating (motor) frequency the amplitude of 50 Hz component exceeds the amplitude of PWM component (Fig. 8). When motor speed is decreased to 50% of the rated value (motor frequency equal to 25 Hz), the amplitude of 25 Hz component is almost equal to the amplitude of PWM component for the arrangement without motor filter and with LCF filter

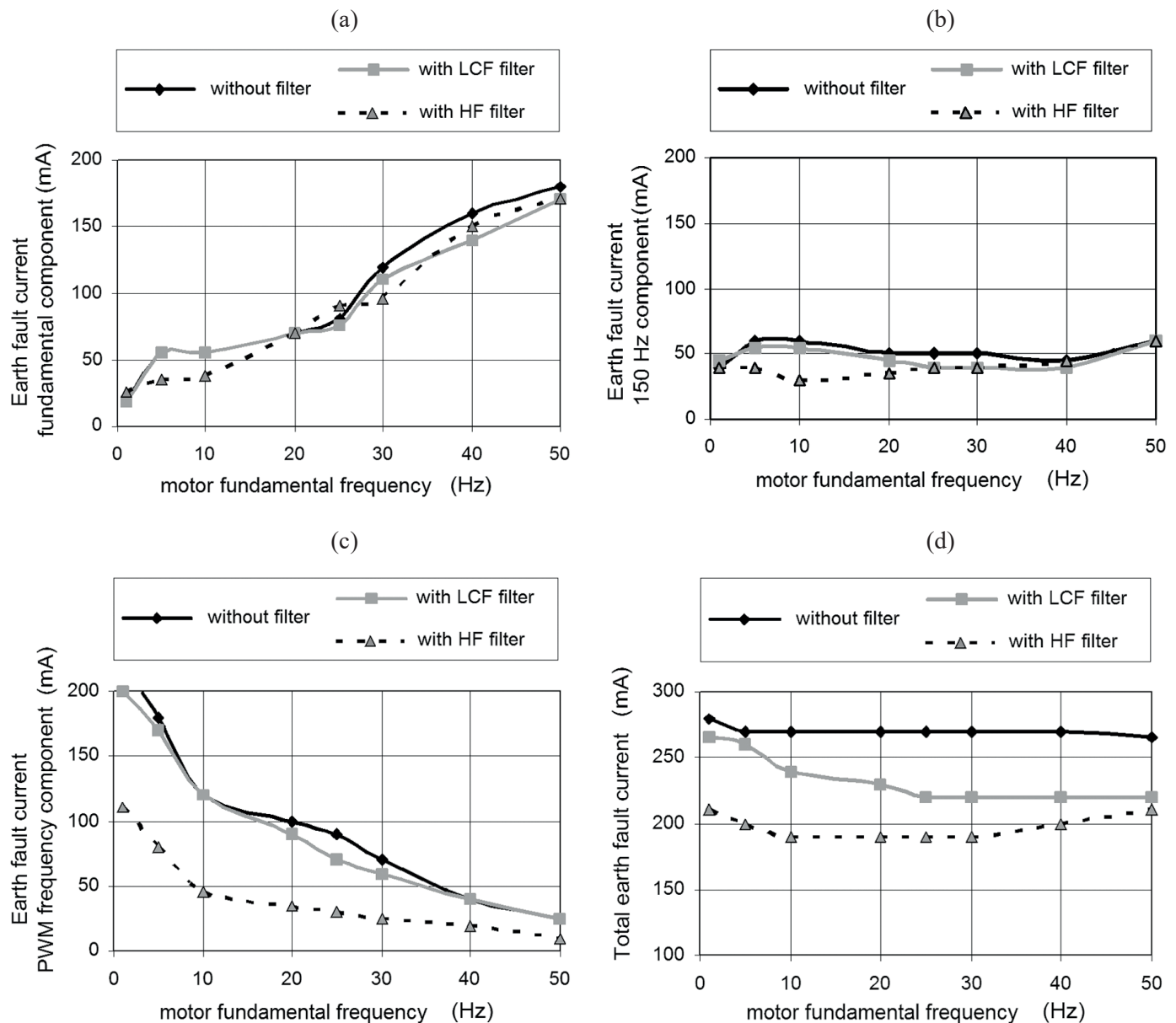

Fig. 11. Content of main components in earth fault current as a function of motor fundamental frequency: a) motor fundamental component, b) 150 Hz, c) PWM frequency, d) total earth fault current

(Fig. 9a and 9b respectively). The third harmonic (75 Hz) of the motor frequency is also visible in the FFT analysis.

For very low motor frequency (1 Hz) the amplitude of PWM component significantly exceeds the amplitude of current of motor frequency and the 150 Hz component (Fig. 10). Such a feature is observed regardless of the presence or absence of the motor filter (both LCF and HF). However, comparing Fig. 10c to Fig. 10a and Fig. 10b one can see that for HF filter the PWM component is significantly lower than for the arrangements with LCF filter or without the filter.

Figure 11 presents a variation of the earth fault current main components (fundamental, 150 Hz and PWM) and total rms value as a function of motor frequency. For the fundamental component (Fig. 11a) all traces have similar characteristics. The

same conclusion comes from Fig. 11b – the value of 150 Hz component. The motor filter (both LCF and HF) has slight impact on fundamental and 150 Hz components in the earth fault currents.

The effect of the motor filter on reducing the earth fault current component is noticeable with reference to PWM component – especially when HF filter (hybrid, differential & common mode filter) is used (Fig. 11c).

When this filter is used, for the whole range of motor frequency (1–50) Hz, PWM component is reduced to about 50% value of the arrangement without filter. Such a reduction of PWM component has an impact on total rms value of the earth fault current. The lowest value of the total earth fault current is for the arrangement with HF filter (Fig. 11d).

4. Evaluation of the shock hazard

Effects of current on the human beings and livestock are included in the report [25]. For long duration of touch current flow and frequency 50/60 Hz, the following values of the current are characteristic:

- a) threshold of perception: 0.5 mA,
- b) threshold of let-go: (5÷10) mA,
- c) threshold of ventricular fibrillation:
 - 30 mA (probability lower than 5%),
 - 50 mA (probability lower than 50%),
 - 80 mA (probability above 50%).

High frequency touch current is less dangerous than current of frequency 50/60 Hz. Variation of the threshold of ventricular fibrillation as a function of frequency is presented in Fig. 12.

One can see that for frequency equal to or higher than 1000 Hz the threshold of ventricular fibrillation is 14 times higher than for frequency equal to 50 Hz.

According to the document [26] the ventricular fibrillation hazard caused by current with harmonics may only be estimated (rough approximation) as equivalent to the hazard caused by a pure sinusoidal current having the following characteristics:

- the fundamental frequency with an amplitude I_{ev} (1) equivalent to the quadratic summation of all component amplitudes I_h individually affected by the appropriate frequency factor F_f as shown in Fig. 12.

$$I_{ev} = \sqrt{\sum_{h=1}^n \left(\frac{I_h}{F_f}\right)^2} \quad (1)$$

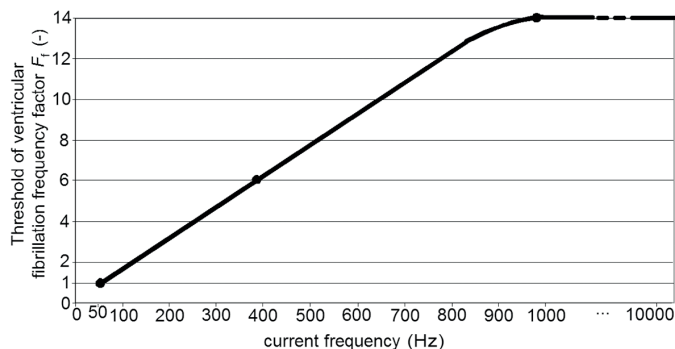

Fig. 12. Frequency factor for the threshold of ventricular fibrillation within the 50 Hz to 10 000 Hz frequency range

Results of calculations according to the (1) are presented in Fig. 13. Equivalent earth current (rms value) was estimated for the following motor frequencies (1, 10, 30 and 50 Hz). As it was prior mentioned, the following three motor arrangements were considered:

- motor filter is not installed,
- LCF filter is installed,
- HF filter is installed.

Ventricular fibrillation hazard is evaluated (Fig. 13) for three levels of the probability (<5%, <50%, >50%). High

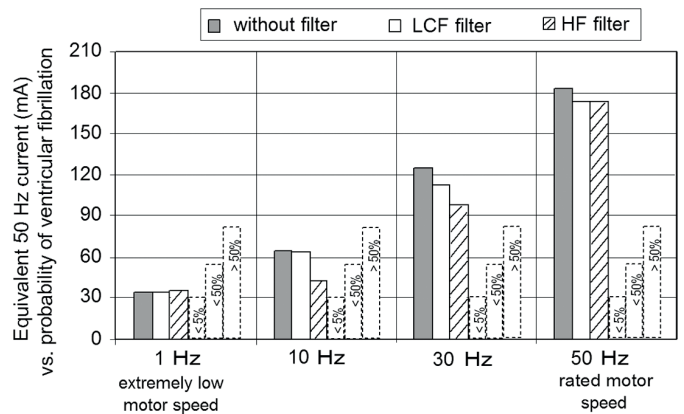

Fig. 13. Example values of equivalent 50 Hz earth fault current vs. probability of ventricular fibrillation

frequency currents are less dangerous than current of frequency equal to 50/60 Hz. Thus, for lower motor frequency (earth current comprises mainly high frequency components) the shock hazard is less probable.

An analysis of the results presented in Fig. 13 has shown that motor filters – especially HF filter – give positive effects. Equivalent earth fault (touch) current is relatively low, therefore the probability of ventricular fibrillation can be decreased. Unfortunately, in all cases presented above, the value of equivalent earth fault current may cause ventricular fibrillation with the probability of about 5% or slight more. The motor filter reduces only high frequency current components which are less dangerous for humans than low frequency components.

5. Tripping of residual current devices

To avoid ventricular fibrillation either during direct contact or indirect contact, residual current devices (RCDs) are installed at the beginning of circuits. The most often applied types of residual current devices are as follows [27]:

- AC – RCDs for detection of residual AC waveforms (50/60 Hz);
- A – RCDs for detection of residual AC waveforms and pulsating direct residual waveforms.

The third type of residual current devices (B-type) is for residual AC waveforms up to 1000 Hz, pulsating direct residual waveforms and smooth direct residual current, but very rarely used due to its high cost.

For rough orientation in tripping current of residual current devices in circuit with variable-speed drives, a test of two residual current devices (commonly used) was performed (Fig. 14). 30 mA residual current devices (one AC-type and one A-type) were tested.

The test was performed according to the diagram presented in Fig. 3. A residual current device was installed upstream the converter and a line-to-earth connection via a resistor of variable resistance was performed. Earth current was increased and tripping current of a residual current device was recorded. The

PWM frequency was equal to 3.3 kHz and no motor filter was used. Tripping current of consecutive residual current devices (RCDs) was checked for wide range of motor frequency (motor speed): 50 Hz (rated motor speed), 40 Hz, 30 Hz, 25 Hz (50% of the rated motor speed), 20 Hz, 10 Hz, 5 Hz, 1 Hz (extremely low motor speed).

Each group of results of the tripping current is compared with the 5% threshold of ventricular fibrillation for touch current with harmonics. This threshold of ventricular fibrillation is calculated according to (1).

The analysis of the results presented in Fig. 14 enables to state that tripping current of the tested residual current devices does not exceed the threshold of ventricular fibrillation only for motor frequencies: 50, 40, 30, 25 and 20 Hz. For motor frequency of 10 Hz only the AC-type device tripped out below the threshold of ventricular fibrillation level. The A-type device opened the circuit but for current equal to 1000 mA! The worst results were obtained for an extremely low motor speed (motor frequency 1 Hz). Due to high level of harmonics none of the tested residual current devices tripped out during this part of the test.

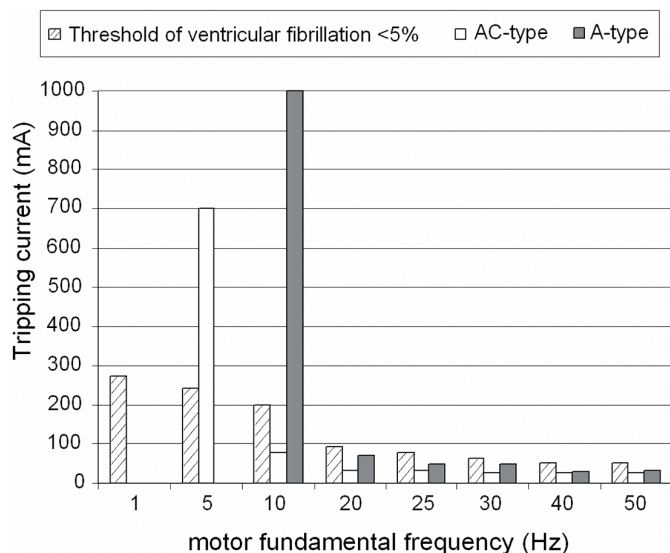

Fig. 14. Tripping current of the selected two RCDs (AC-type and A-type) versus threshold of ventricular fibrillation; no motor filter in the circuit

In order to compare tripping current of many residual current devices in presence of harmonics and avoid influence of disturbances (leakage currents, magnetic and capacitive couplings) which are present in power electronics converters circuits, a laboratory stand for testing of residual current devices has been prepared. This laboratory stand enables the generation of main harmonics which occur in variable-speed drive circuits. Figure 15 presents a diagram of the laboratory stand. This stand is comprised of a multi-harmonics generator, a PC for control of the generator, a digital oscilloscope and a true rms ammeter for recording the tripping current of residual current devices.

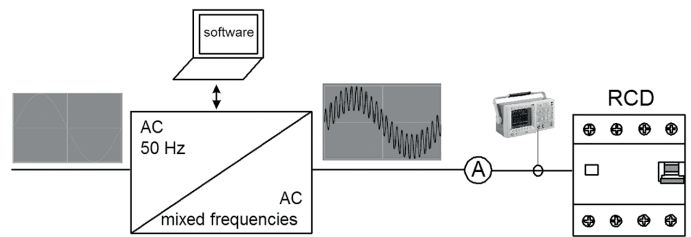

Fig. 15. Simplified diagram of the laboratory stand for testing of tripping current of residual current devices

With the use of laboratory multi-harmonics generator this part of the test was performed for three types of the currents [5]. The first type of the current (marked “50 Hz” in Table 1) comprises harmonics which dominate in the earth fault current in case of fault in the output terminals of PWM inverters for motor frequency equal to 50 Hz.

Table 1
Harmonics content in the test currents

Waveform type	Content of harmonics
pure sine wave (reference waveform)	50 Hz from laboratory generator
“50 Hz”: reflects phase-to-earth current waveform for rated motor speed	50 Hz (motor frequency), 150 Hz, 900 Hz, 1000 Hz (PWM), 1100 Hz
“25 Hz”: reflects phase-to-earth current waveform for 50% of rated motor speed	25 Hz (motor frequency), 75 Hz, 150 Hz, 1000 Hz (PWM)
“1 Hz”: reflects phase-to-earth current waveform for extremely low motor speed	1 Hz (motor frequency – negligible), 150 Hz, 1000 Hz (PWM)

The second type of the test current (marked “25 Hz” in Table 1) reflects the earth fault current in case of earth fault in the output terminals of PWM inverters for motor frequency equal to 25 Hz. The third type of the test current (marked “1 Hz” in Table 1) reflects the earth fault current for motor frequency equal to 1 Hz [5]. The content of harmonics for all test currents is presented in Table 1 as well. The PWM frequency is assumed to be 1000 Hz.

Figure 16a presents an oscillogram of an example test waveform obtained from the multi-frequency generator. This waveform reflects earth current flowing in case of fault during extremely low motor speed “1 Hz” (see Table 1). A real earth current waveform from a variable-speed drive circuit is shown in Fig. 16b. One can see that the modeled waveform is in good convergence with the real waveform.

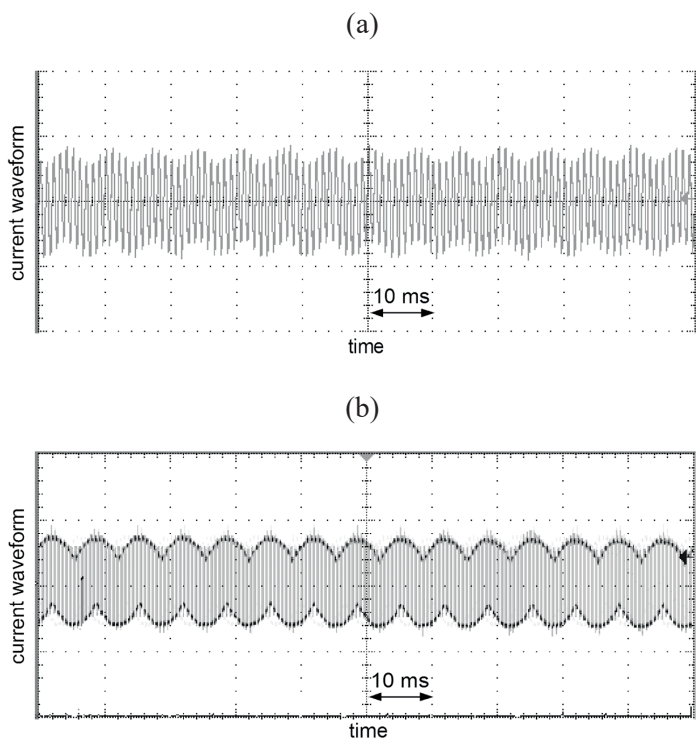

Fig. 16. Earth fault current: a) generated in multi-harmonics generator, PWM frequency 1 kHz; b) from real circuit – PWM frequency 1.67 kHz

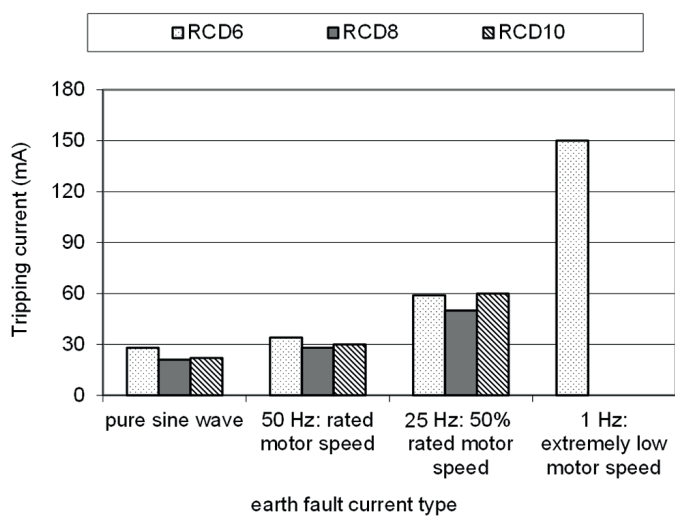

Fig. 17. Tripping current of the selected three RCDs of $I_{\Delta n} = 30$ mA (RCD6, RCD8, RCD10: AC-type) for modelled variable-speed drive earth fault currents

A wide population (over 40) of residual current devices was tested. Figures from 17 to 21 show tripping current of the selected residual current devices representing the following groups of these devices:

- 30 mA, AC-type – Fig. 17,
- 30 mA, A-type – Fig. 18,
- 100 mA, AC-type and A-type – Fig. 19,

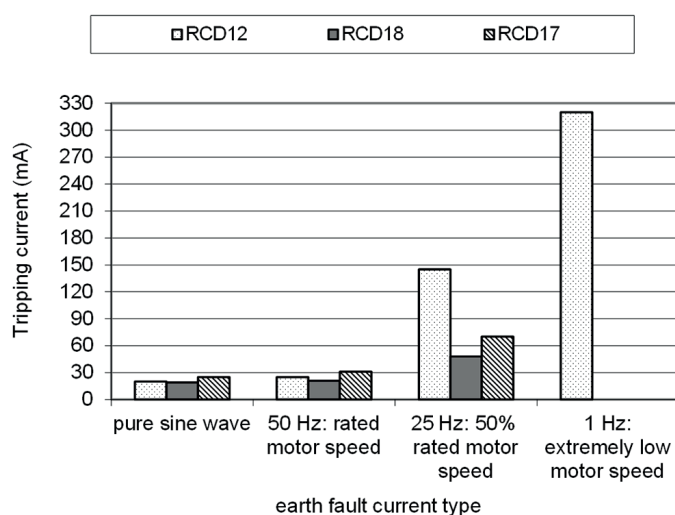

Fig. 18. Tripping current of the selected three RCDs of $I_{\Delta n} = 30$ mA (RCD12, RCD17, RCD18: A-type) for modelled variable-speed drive earth fault currents

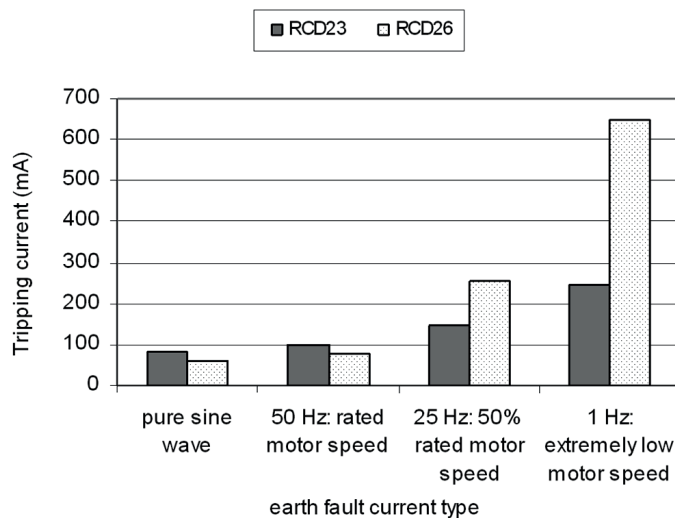

Fig. 19. Tripping current of the selected two RCDs of $I_{\Delta n} = 100$ mA (RCD23: AC-type; RCD26: A-type) for modelled variable-speed drive earth fault currents

- 300 mA, AC-type – Fig. 20,
- 300 mA, A-type – Fig. 21.

For the reference sine wave each of the tested residual current device tripped out within the permissible level (not exceeding the rated residual current). When test current reflecting earth fault current for rated motor speed “50 Hz” was forced, tripping current of the residual current devices was only slightly higher than the one obtained for pure sine wave. For the test current “25 Hz” a large dispersion of results was noted. However, for all tested residual current devices with the rated residual current 30 and 100 mA the tripping current was higher than the rated current. Especially highly increased tripping threshold was observed for RCD12 (Fig. 18) – almost 150 mA instead of 30 mA. The worst waveform for the tested residual current

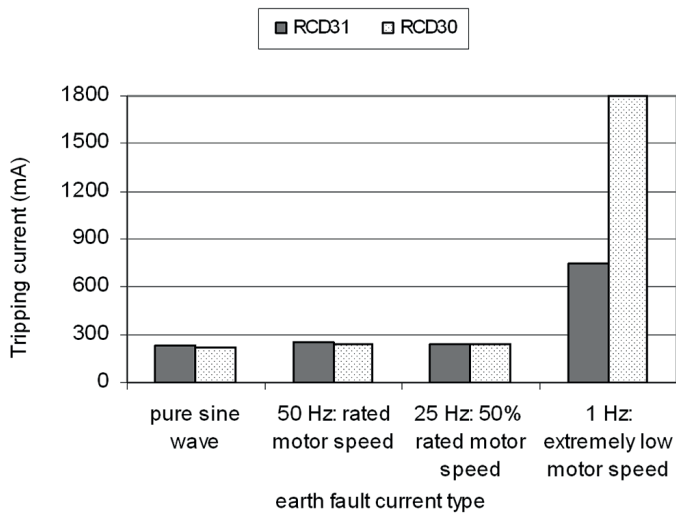

Fig. 20. Tripping current of the selected two RCDs of $I_{\Delta n} = 300$ mA (RCD30, RCD 31: AC-type) for modelled variable-speed drive earth fault currents

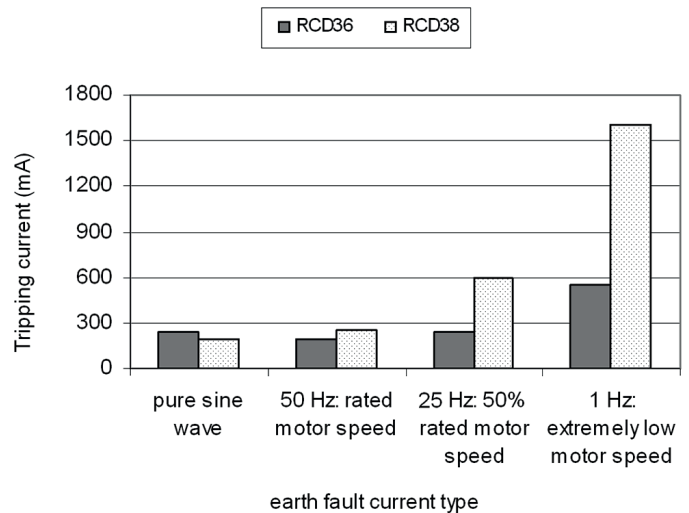

Fig. 21. Tripping current of the selected two RCDs of $I_{\Delta n} = 300$ mA (RCD36, RCD 38: A-type) for modelled variable-speed drive earth fault currents

devices was the “1 Hz” one, which reflects earth fault current for extremely low motor speed. Some residual current devices (RCD8, RCD10, RCD17, RCD18) did not trip during this test. The other tripped out but their tripping current was higher (in some cases significantly higher) than the rated current.

In the “1 Hz” waveform the dominating current component is a high frequency component (1000 Hz) and this is the cause of a dangerous rise of the tripping threshold.

Results of the test presented above enable to state that the most commonly used residual current devices (AC-type and A-type) are characterized by high level of tripping current when earth fault occurs for a low motor speed. A test of a B-type residual current device has been performed as well (Fig. 22). The

tripping characteristic of this type of residual current device is also dependent by the waveform type and for the “1 Hz” waveform the RCD tripped out at current value many times higher than for pure sine wave.

To avoid dependency of high frequency components on the tripping current, a residual current device of $I_{\Delta n} = 300$ mA (prototype, laboratory version – according to the patent [28]) was constructed and tested. This prototype residual current device was tested under the prior mentioned test currents: “50 Hz”, “25 Hz” and “1 Hz”. The results of the test are presented in Fig. 23. For all test currents the tripping threshold of the proposed residual current device is almost the same and does not exceed the rated residual current (300 mA).

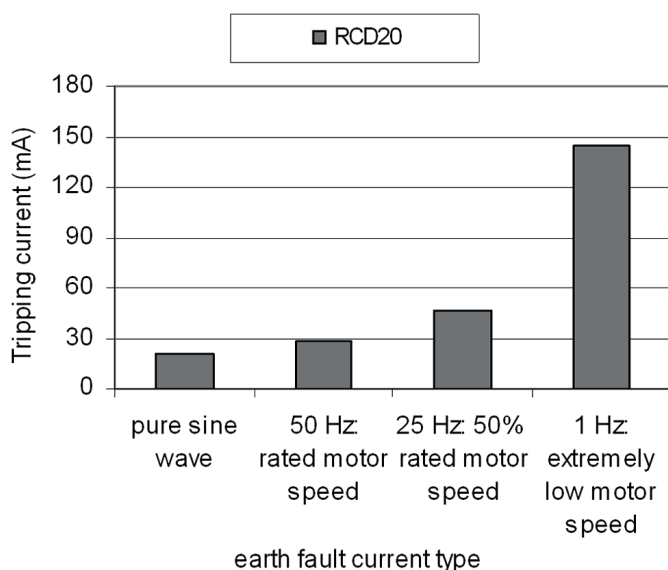

Fig. 22. Tripping current of the selected RCD of $I_{\Delta n} = 30$ mA, B-type for modelled variable-speed drive earth fault currents

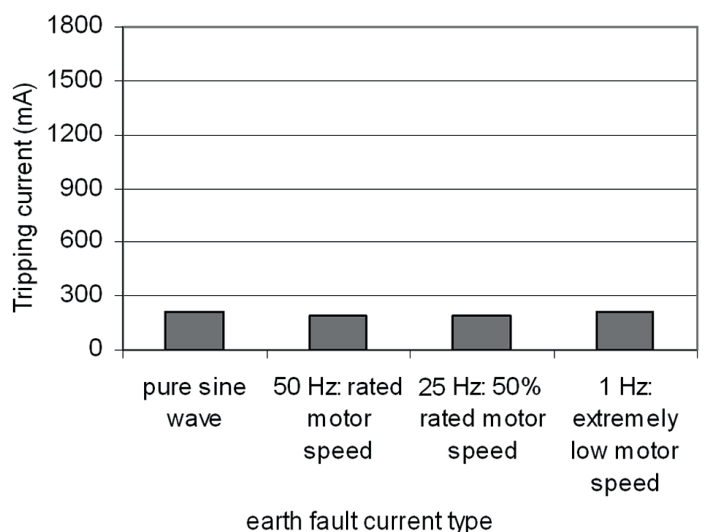

Fig. 23. Tripping current of the proposed RCD of $I_{\Delta n} = 300$ mA for modelled variable-speed drive earth fault currents

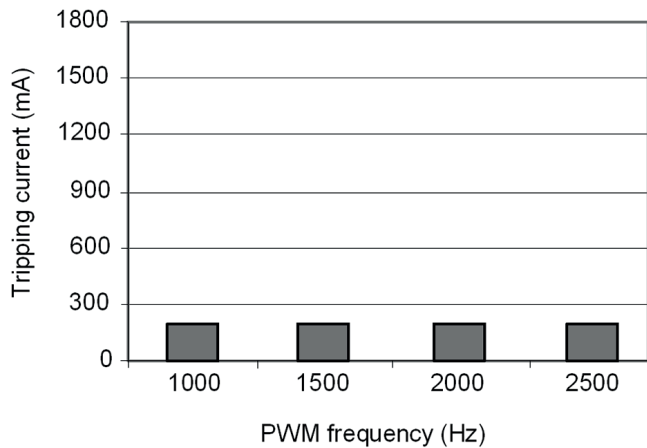

Fig. 24. Tripping current of the proposed RCD of $I_{\Delta n} = 300$ mA for selected PWM frequency and extremely low motor speed

The effect of high frequency components (due to PWM frequency) on tripping of the proposed residual current device was also checked (Fig. 24). The test was performed only for the waveform “1 Hz” which is the most inconvenient for residual current devices. The modelled PWM frequency was equal to 1000, 1500, 2000 and 2500 Hz. This test proved that the behavior of the proposed residual current device for current containing high frequency component is favorable. This proposed RCD can be qualified to a new type of residual current devices (F-type) which is considered in the standard [29] and is dedicated to circuits with multi-frequency earth currents.

6. Conclusion

The study of the electric shock hazard in circuits with variable-speed drives has shown that earth fault current (touch current as well) comprises harmonics which influence both the threshold of ventricular fibrillation and tripping threshold of residual current devices. The content of harmonics depends on the PWM frequency, actual motor speed and type of inverter output (motor) filter. High-order harmonics are less dangerous for persons than relatively low frequency components. However, when earth current contains mainly high frequency components, reliable operation of protective residual current devices is doubtful. Only residual current devices with examined tripping current in presence of harmonics should be applied.

REFERENCES

[1] Protection against electric shock. Common aspects for installation and equipment, EN 61140, (2002).
 [2] Low-voltage electrical installations – Part 4–41: Protection for safety – Protection against electric shock, HD 60364–4–41, (2007).
 [3] S. Czapp and D. Swisulski, “Computer system for evaluation of shock hazard in circuits with non-sinusoidal earth currents”, *Int. School on Nonsinusoidal Currents and Compensation (ISNCC)*, (2015), DOI: 10.1109/ISNCC.2015.7174684.

[4] S. Czapp, “Comparison of residual current devices tripping characteristics for selected residual current waveforms”, *Elektronika i Elektrotechnika* 100 (4), 7–10 (2010).
 [5] S. Czapp, “The impact of higher-order harmonics on tripping of residual current devices”, *Proc. Int. Power Electronics and Motion Control Conference EPE-PEMC 2008*, Poznan, (2008), DOI: 10.1109/EPEPEMC.2008.4635569.
 [6] M. Mitolo, “Shock hazard in the presence of protective residual-current devices”, *IEEE Trans. on Industry Applications* 46 (4), 1552–1557 (2010), DOI: 10.1109/TIA.2010.2051068.
 [7] S.T. Donahue, C.L. Storm, Jr. D.A. Wetz, and W.-J. Lee, “Study of the effects of smart meter RF transmissions on GFCI outlets”, *IEEE Trans. on Electromagnetic Compatibility* 56 (6), 1361–1369 (2014), DOI: 10.1109/TEMC.2014.2354016.
 [8] C. Roldán-Porta, G. Escrivá-Escrivá, F.J. Cárcel-Carrasco, and C. Roldán-Blay, “Nuisance tripping of residual current circuit breakers: A practical case”, *Electric Power Sys. Research* 106, 180–187 (2014), DOI: 10.1016/j.epsr.2013.07.020.
 [9] A. Mohd Zaki and A. Rusnani, “Power quality analysis of Residual Current Device [RCD] nuisance tripping at commercial buildings”, *2013 IEEE Symposium on Industrial Electronics and Applications (ISIEA)*, 122–125 (2013), DOI: 10.1109/ISIEA.2013.6738980.
 [10] X. Luo, Y. Du, X.H. Wang, and M. L. Chen, “Tripping characteristics of residual current devices under nonsinusoidal currents”, *IEEE Trans. on Industry Applications* 47 (3), 1515–1521 (2011), DOI: 10.1109/TIA.2011.2125939.
 [11] F. Freschi, “High-frequency behavior of residual current devices”, *IEEE Trans. on Power Delivery* 27 (3), 1629–1635 (2012), DOI: 10.1109/TPWRD.2012.2191423.
 [12] V. Cocina, P. Colella, E. Pons, R. Tommasini, and F. Palamara, “Indirect contacts protection for multi-frequency currents ground faults”, *2016 IEEE 16th International Conference on Environment and Electrical Engineering (EEEIC)*, 1–5 (2016), DOI: 10.1109/EEEIC.2016.7555701.
 [13] H. Abu-Rub, A. Iqbal, and J. Guzinski, *High Performance Control of AC Drives with Matlab/Simulink Models*, Wiley, 2012.
 [14] H. Abu-Rub, S. Bayhan, S. Moinoddin, M. Malinowski, and J. Guzinski, “Medium-voltage drives: Challenges and existing technology”, *IEEE Power Electronics Magazine* 3 (2), 29–41 (2016), DOI: 10.1109/MPEL.2016.2551802.
 [15] H. Akagi, “Prospects and expectations of power electronics in the 21st century”, *Power Conversion Conference, PCC’2002*, Osaka, Japan (2002), DOI: 10.1109/PCC.2002.998092.
 [16] H. Akagi, H. Hasegawa, and T. Doumoto, “Design and performance of a passive EMI filter for use with a voltage-source PWM inverter having sinusoidal output voltage and zero common-mode voltage”, *IEEE Trans. on Power Electronics* 19 (4), 1069–1076 (2004), DOI: 10.1109/TPEL.2004.830039.
 [17] B.K. Bose, “Power electronics and motor drives recent progress and perspective”, *IEEE Trans. on Industrial Electronics* 56 (2), 581–588 (2009), DOI: 10.1109/TIE.2008.2002726.
 [18] S. Czapp and J. Guzinski, “The effect of the motor filters on earth fault current waveform in circuits with variable speed drives”, *International School on Nonsinusoidal Currents and Compensation (ISNCC)*, 1–6 (2013), DOI: 10.1109/ISNCC.2013.6604442.
 [19] P. Wiatr and M.P. Kazmierkowski, “Model predictive control of multilevel cascaded converter with boosting capability – a simulation study”, *Bull. Pol. Ac.: Tech.* 64 (3), 581–590 (2016), DOI: 10.1515/bpasts-2016-0065.

- [20] T. Orłowska-Kowalska and M. Dybkowski, "Performance analysis of the sensorless adaptive sliding-mode neuro-fuzzy control of the induction motor drive with MRAS-type speed estimator", *Bull. Pol. Ac.: Tech.* 60 (1), 61–70 (2012), DOI: 10.2478/v10175-012-0010-0.
- [21] A. Muetze and E. G. Strangas, "The useful life of inverter-based drive bearings: methods and research directions from localized maintenance to prognosis", *IEEE Industry Applications Magazine* 22 (4), 63–73 (2016), DOI: 10.1109/MIAS.2015.2459117.
- [22] V. Niskanen, A. Muetze, and J. Ahola, "Study on bearing impedance properties at several hundred kilohertz for different electric machine operating parameters", *IEEE Trans. on Industry Applications* 50 (5), 3438–3447 (2014), DOI: 10.1109/TIA.2014.2308392.
- [23] J. Guzinski, H. Abu-Rub, and P. Strankowski, *Variable Speed AC Drives with Inverter Output Filters*, Wiley, 2015.
- [24] P. Pairodamonchai and S. Sangwongwanich, "Exact common-mode and differential-mode equivalent circuits of inverters in motor drive systems taking into account input rectifiers", *IEEE PEDS Conference*, Singapore, (2011), DOI: 10.1109/PEDS.2011.6147259.
- [25] Effects of current on human beings and livestock. Part 1: General aspects, IEC/TS 60479-1, (2005).
- [26] Effects of current on human beings and livestock. Part 2: Special aspects, IEC/TS 60479-2, (2007).
- [27] General requirements for residual current operated protective devices, IEC 60755, (2008).
- [28] S. Czapp, "Differentiating current switch", Polish patent PL000000211991B1, (2012), <https://depatisnet.dpma.de/DepatisNet/depatisnet?action=bibdat&docid=PL000000211991B1>
- [29] Type F and type B residual current operated circuit-breakers with and without integral overcurrent protection for household and similar uses, EN 62423, (2012).