

Finite element method simulations of various cases of crash tests with N2/W4/A steel road barrier

Stanisław Burzyński^{1*}, Jacek Chróścielewski¹, and Lukasz Pachocki¹

¹ Gdańsk University of Technology, Faculty of Civil and Environmental Engineering, Department of Mechanics of Materials and Structures, ul. Narutowicza 11/12, 80-233 Gdańsk, Poland

Abstract. The subject of this study is performance of N2/W4/A steel road safety barrier investigated in numerical simulations. System was checked under several types of initial conditions, which were assumed basing on the TB11 and TB32 normative crash tests. The main goal of present study is to investigate the relationship between initial conditions (angle and velocity) of the impact and the severity indices (associated to the vehicle occupant) during the collision. Obtained performance parameters and impact severity indexes may be considered reasonable. Results of the simulations facilitates the deep insight into vehicle crash mechanics phenomena.

1 Introduction

Steel barriers of various types (including variety of rail and post shapes, post spacing, barriers heights) are commonly placed on Polish roadsides to protect vehicle from leaving the road and ensure the safety of vehicles occupants or protect objects beside the barrier. Great effort is made by road management and road safety equipment manufacturers to find balance between effectiveness, quality and economic aspects in barrier placing and maintenance problems. Research projects RID 3A “Road Safety Equipment” and RID 3B “Life Cost Analysis of Road Safety Equipment” deal with selected problems in this area, present work consist of numerical analysis which are auxiliary tool in the process of preparing new guidelines for placement and maintenance of road safety equipment.

Therefore, it is justified and unavoidable that the analysis of the mechanics of vehicle collision with the barrier is conducted on the advanced computer aided programs. Such programs are used commonly in many solving many types of engineering problems. Finite element method (FEM) plays crucial role in simulating crash tests and their violent and highly nonlinear nature. One of the possible choices of the FEM system is LS-DYNA [1,2] Since their application to ensuring the safety of vehicle occupants, computer simulations of crash test events have to follow specified requirements for full-scale crash tests experiments which can be found in standard [3]. Additional literature concerning numerical simulations have been published in 2012 [4]. Validation procedures have been specified there and precise conditions which numerical simulation must fulfil are listed. The subject of crash tests numerical modelling has already been widely described in the literature [5–14].

Up to date, in Poland permissible speed for vehicles under 3.5 tons on highways equals to 140 km/h. Tests under such a conditions are not required by the standards [3], therefore

* Corresponding author: stanislaw.burzynski@pg.edu.pl

they are rarely conducted. In this case nonlinear finite element analysis can be a great support for the engineers to predict the possible scenario of a collision. Especially, the high velocity accidents are most dangerous and then the guideway's breakage must be taken into consideration. The most obvious place that is exposed to this type of event is the bolted connection between adjacent guideways. Couple of papers concerning the topic of modelling bolted joints have been published already [15–20].

The subject of this study is N2/W4/A steel road safety barrier which is shown in fig. 1. The barrier used in simulations was 60 meters long with 14-meter section mounted in the ground. Appropriate performance parameters along with impact severity indexes [1] were gathered during the analyses. System was investigated for the behavior under several types of initial conditions, which were assumed basing on the TB11 and TB32 normative crash tests [1].

During this work efforts were made to present reliable results for various types of crash tests. Therefore, the numerical model used in this paper positively passed validation procedures according to British Standards [4]. The main goal of present study is to investigate the relationship between initial conditions (angle and velocity) of the impact and the severity indices (associated to the vehicle occupant) during the collision, simulated in virtual environment of the LS-DYNA FEM system. In addition, the influence of the initial conditions on the performance parameters of the steel road safety system N2/W4/A are studied. Other important features of the study is to give insight of the crash tests cases, which are not required by the European Standards.

The paper is organized as follows Section 2 gives a brief description of the methods used in order to obtain a reliable results that are included later in section 3. The last section summarizes the work and contains general conclusions.



Fig. 1 N2/W4/A steel road safety barrier on A1 highway in Poland, credits: Google Earth.

2 Method

First step of the model preparation is a proper recreation of the model's geometry. Then the finite element meshing should be performed, with average element size about 10-15 mm. Fully integrated shell elements formulation (element formulation 16) were used with 5 points on thickness integration, with the shear correct factor equal to $5/6$. Sample of the FEM models with the names of parts for this particular barrier type are shown in fig. 2. According to the standards, bolt holes in the barrier parts may be omitted, when they have

relatively small dimensions [2] . Thus, barrier elements were connected with two types of connections. Adjacent barrier guideways bolt connection were modelled using discrete beams [1,2]. This approach was introduced and used with success in several papers concerning crash tests numerical simulations [9,11,20] LS-DYNA's material law used for the bolts in the model is *MAT_NONLINEAR_PLASTIC_DISCRETE_BEAM. In general it acts as a cluster of 6 springs operating with adequate stiffness, assigned to the directions of degrees of freedom in each of the beam nodes. Material data was acquired during bolt connection laboratory test. Simplified approach was used in the connections between the extension arms and the guideways as well as the extension arms and posts. In order to connect mentioned above elements LS-DYNA's spot welding technique was used [1,2]. Every spot weld consists of 4 hexahedral constant stress solid elements with the *MAT_SPOTWELD material law. Material data for the bolts in connection was gathered in laboratory tension tests. According to the good engineering practice the data for *MAT_SPOTWELD was assumed as a weaker from the two data series of the connecting parts.

In present research, ground was modelled using hexahedral constant stress elements. In order to prevent negative volume error occurrence adequate size elements were used (fig. 3) along with dedicated *CONTACT_INTERIOR logic. Parameters for the material model of soil were assumed according to the literature [21,22].

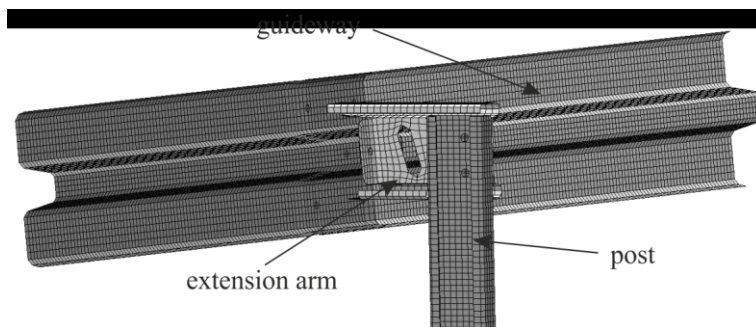

Fig. 2 Sample of the barriers FEM.

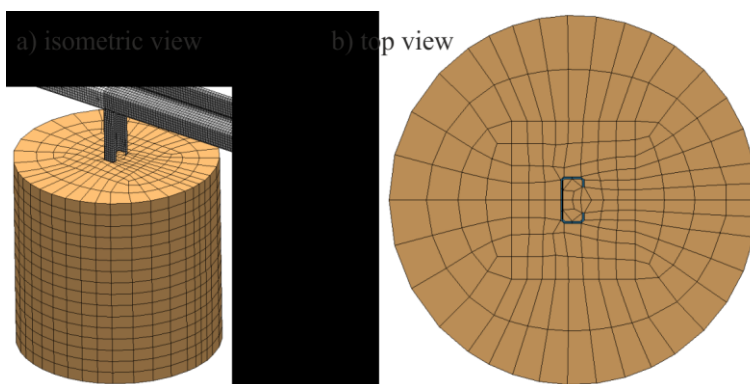

Fig. 3 Soil around the posts in a) isometric view and b) top view.

One global contact was set along with additional friction definition for the tires – asphalt interaction. In order to prevent the unwanted hourglass energy to occur the Flangan – Belytschko stiffness form of hourglass control was used [1,2,23]

In order to get a reliable results for the numerical crash tests the model validation is obligatory. There are specified criteria that have to be fulfilled before performing additional

parametric analyses. The normative papers that are mandatory in most European countries are British Standards [4]. Another are American recommendations that include more restrictive requirements [24] and suggest using free third party software based on ANOVA and MPC [25,26] Most of the requirements were fulfilled by the presented numerical model of the steel barrier N2/W4/A. It should be noted that the same barrier model has passed both validation procedures for TB11 and TB32 [3] crash tests. Exemplary crash test result is shown in fig. 4. The comparison of the full scale barrier with the numerical model can be seen in fig. 5. Parametric analysis was performed for the two types of vehicles: Geo Metro (900 kg) and BMW (1500 kg), see fig. 6. They were put into simulations with varying initial conditions of the impact e.g.: initial velocity and impact angle.



Fig. 4 Steel road safety barrier N2/W4/A after exemplary crash test



Fig. 5 Comparison between steel road safety barrier and corresponding numerical model

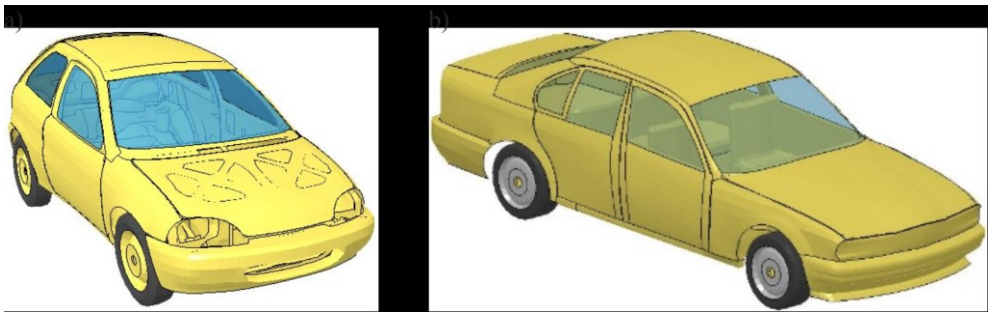

Fig. 6 Vehicles used in simulations: a) Geo Metro b) BMW

3 Results

The calculations of the total number of 18 numerical simulations have been carried out at the Academic Computer Centre in Gdańsk, Gdańsk University of Technology. All of them were completed successfully, namely led to stable solution without numerical issues like “shooting nodes” or non-physical deadlock in contact. Two types of vehicles: Geo Metro

(900 kg) and BMW (1500 kg) were used with the varying initial impact conditions set. Appropriate performance parameters of the barrier were acquired according to the normative requirements [3]. Impact severity indexes were calculated basing on the accelerations gathered by the accelerometer mounted in vehicle's center of gravity [3].

General course overview of the two types of initial conditions for the Geo Metro tests is shown in fig. 7. As expected, as initial kinetic energy raised, deeper and wider deformation was observed. Additional results views for the comparison are shown in fig. 7 and fig. 8.

Another exemplary results for different vehicle type were shown in fig. 9. This time they concerned the BMW 20° crash test for velocity equal to 110 km/h and 140 km/h. Results of the numerical simulation show that the barrier may brake under the described initial conditions. However, it should be noted that according to the simulation results this phenomena may occur only under extreme initial conditions. All set of the results are collected in the table 1. Additional graph shows the magnitude of working width with respect to initial kinetic energy are placed in fig. 10.

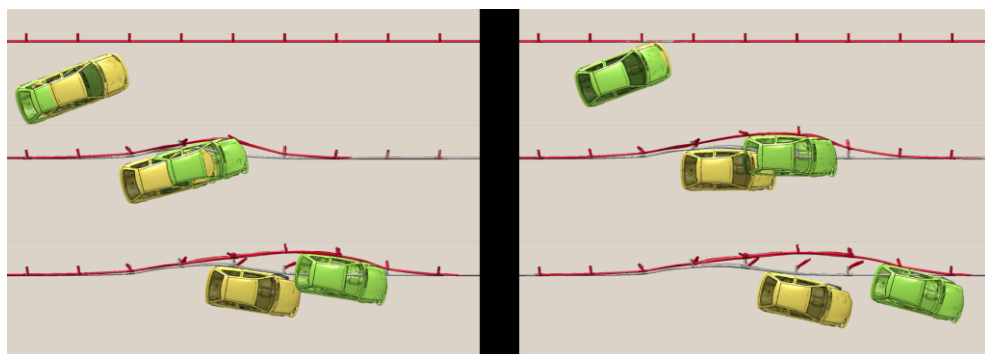

Fig. 7 Results for the Geo Metro crash tests:
yellow – angle 20°, velocity 90 km/h; green – angle 20°, velocity 140 km/h.

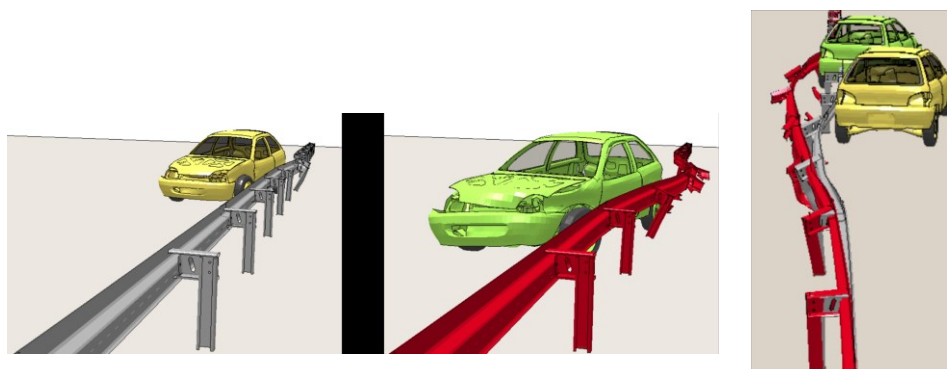

Fig. 8 Additional views for the last state (6th) shown in Fig. 7:
yellow – angle 20°, velocity 90 km/h; green – angle 20°, velocity 140 km/h.

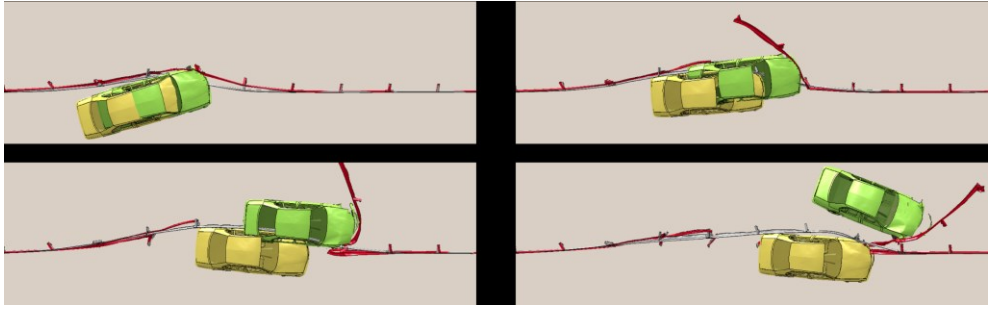

Fig. 9 Results for the BMW crash tests:
 yellow – angle 20°, velocity 110 km/h ; green – angle 20°, velocity 140 km/h .

Table 1. Summarization of the tests that have been carried out.

Angle °	Velocity km/h	Kinetic Energy kJ	ASI -	THIV km/h	Working width m	Dynamic deflection m
TB11						
10	90	8.5	0.5	18.9	0.5	0.2
	110	12.7	0.5	21.7	0.6	0.3
	140	20.5	0.8	25.8	0.7	0.4
20	90	32.9	0.9	27.5	0.7	0.4
	110	49.1	1	30.1	0.8	0.7
	140	79.6	1.2	31.8	1.3	1
25	90	50.2	1.1	33	1	0.6
	110	75.0	1.1	34.5	1	0.8
	140	121.6	1.4	38.3	barrier broken	
TB32						
10	90	14.1	0.5	15.4	0.6	0.2
	110	21.1	0.6	18.4	0.6	0.4
	140	34.2	0.7	20.9	0.7	0.5
20	90	54.8	0.7	23.1	0.8	0.7
	110	81.9	0.6	21.1	1.4	1.1
	140	132.7	0.9	25	barrier broken	
25	90	83.7	0.9	33.1	1.4	1
	110	125.1	0.8	21.6	barrier broken	
	140	202.6	0.8	15	barrier broken	

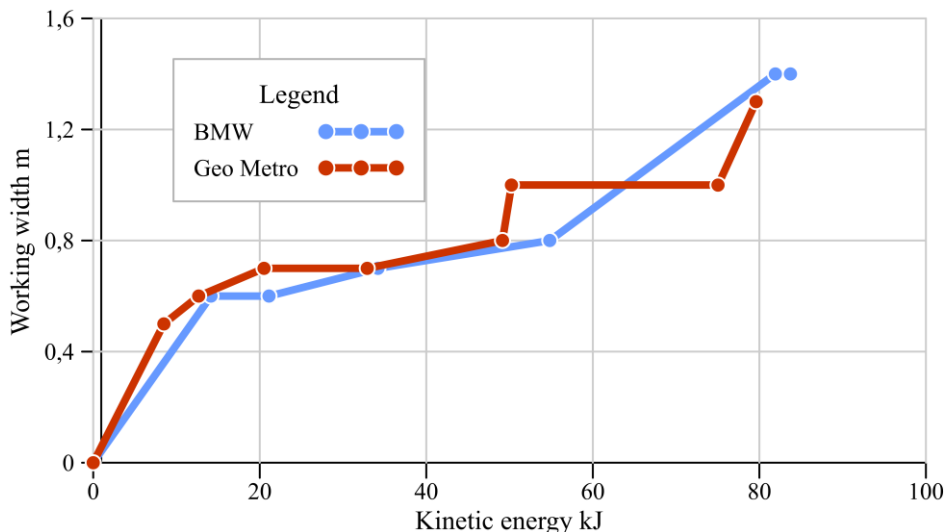

Fig. 10 Working width as a function of initial kinetic energy for different vehicle types

4 Conclusions

Results included in this paper show the exemplary usage of numerical simulations as a supplementary tool for solving engineering problems. Modelling process of the steel road safety barrier was briefly discussed. Wide range study of initial parameters in TB11 and TB32 test was performed. Results show, that performance parameter of barrier (working width) depends on initial kinetic energy of passenger car, rather than it's weight.

This work was supported by the National Centre for Research and Development (NCBiR) and General Directorate for National Roads and Motorways (GDDKiA), Poland. The research project name was "Life Cost analysis of Road Safety Elements" (contract number DZP/RID-I-64/12/NCBR/2016 and DZP/RID-I-67/13/NCBR/2016). LS-DYNA calculations were carried out at the Academic Computer Centre in Gdańsk, Gdańsk University of Technology.

References

1. J.O. Hallquist, LS-DYNA Theory Manual (Livermore Software Technology Corporation, 2006)
2. LS-DYNA Keyword User's Manual (Livermore Software Technology Corporation, 2015)
3. European Standard EN 1317-1-5 (2010)
4. British Standard PD CEN/TR 16303-1-5 (2012)
5. K. Jamroz, S. Burzyński, W. Witkowski, K. Wilde, Numerical methods for the assessment of bridge safety barriers, in: M. Kleiber, T. Burczyński, K. Wilde, J. Gorski, K. Winkelmann, Ł. Smakosz (Eds.), Adv. Mech. Theor. Comput. Interdiscip. Issues, 1st ed., pp. 231–234 (CRC Press, 2016)
6. W. Borkowski, Z. Hryciów, P. Rybak, J. Wysocki, Numerical simulation of the standard TB11 and TB32 tests for a concrete safety barrier, KONES Powetrain Transp. **17** (2010)
7. M. Borovinšek, M. Vesenjāk, M. Ulbin, Z. Ren, Simulation of crash tests for high

- containment levels of road safety barriers, *Eng. Fail. Anal.* **14** pp. 1711–1718 (2007). doi:10.1016/J.ENGFAILANAL.2006.11.068
8. K. Wilde, K. Jamroz, D. Bruski, S. Burzyński, J. Chróścielewski, W. Witkowski, Numerical simulations of bus crash-test with barrier and truss supporting structure (in Polish), *J. Civ. Eng. Environ. Archit.* **63** pp. 455–467 (2016)
 9. M. Klasztorny, D.B. Nycz, P. Szurgott, Modelling and simulation of crash tests of N2-W4-A category safety road barrier in horizontal concave arc, *Int. J. Crashworthiness.* **21** pp. 644–659 (2016). doi:10.1080/13588265.2016.1212962
 10. K. Wilde, D. Bruski, S. Burzyński, J. Chróścielewski, W. Witkowski, Numerical crash analysis of the cable barrier, in: J. Awrejcewicz, M. Kaźmierczak, J. Mrozowski, P. Olejnik (Eds.), *DSTA-2017 Conf. Books*, pp. 555–566 (Department of Automation, Biomechanics and Mechatronics, 2017)
 11. M. Klasztorny, K. Zielonka, D.B. Nycz, P. Posuniak, R.K. Romanowski, Experimental validation of simulated TB32 crash tests for SP-05/2 barrier on horizontal concave arc without and with composite overlay, *Arch. Civ. Mech. Eng.* **18** pp. 339–355 (2018). doi:10.1016/J.ACME.2017.07.007
 12. K. Wilde, K. Jamroz, D. Bruski, M. Budzyński, S. Burzyński, J. Chroscielewski, W. Witkowski, Curb-to-Barrier Face Distance Variation an a TB51 Bridge Barrier Crash Test Simulation, *Arch. Civ. Eng.* **63** pp. 187–199 (2017). doi:<https://doi.org/10.1515/ace-2017-0024>
 13. M.R. Ferdous, A. Abu-Odeh, R.P. Bligh, H.L. Jones, N.M. Sheikh, Performance limit analysis for common roadside and median barriers using LS-DYNA, *Int. J. Crashworthiness.* **16** pp. 691–706 (2011). doi:10.1080/13588265.2011.623023
 14. T.-L. Teng, C.-C. Liang, T.-T. Tran, Development and validation of a finite element model for road safety barrier impact tests, *Simulation.* **92** pp. 565–578 (2016). doi:10.1177/0037549716644507
 15. M. Hadjoannou, D. Stevens, M. Barsotti, Development and Validation of Bolted Connection Modeling in LS-DYNA ® for Large Vehicle Models, in: *14th Int. LS-DYNA Conf.*, pp. 1–12 (2016)
 16. S. Narkhede, N. Lokhande, B. Gangani, G. Gadekar, Bolted Joint Representation in LS-DYNA to Model Bolt Pre-Stress and Bolt Failure Characteristics in Crash Simulations, in: *11th Int. LS-Dyna Users Conf.*, pp. 11–20 (2010)
 17. R. Rahbari, A. Tyas, J. Buick Davison, E.P. Stoddart, Web shear failure of angle-cleat connections loaded at high rates, *J. Constr. Steel Res.* **103** pp. 37–48 (2014). doi:10.1016/j.jcsr.2014.07.013
 18. J.D. Reid, N.R. Hiser, Detailed modeling of bolted joints with slippage, *Finite Elem. Anal. Des.* **41** pp. 547–562 (2005). doi:10.1016/j.finel.2004.10.001
 19. D.A.F. Bayton, T.B. Jones, G. Fournalis, Analysis of a safety barrier connection joint post-testing, *Mater. Des.* **29** pp. 915–921 (2008). doi:10.1016/j.matdes.2007.04.010
 20. D.B. Nycz, Modelowanie złączy śrubowych segmentów prowadnicy typu B bariery drogowej SP-05/2, *Model. Inżynierskie*. pp. 105–112 (2016)
 21. W. Wu, R. Thomson, A study of the interaction between a guardrail post and soil during quasi-static and dynamic loading, *Int. J. Impact Eng.* **34** pp. 883–898 (2007). doi:10.1016/j.ijimpeng.2006.04.004
 22. E.L. Fasanella, K.E. Jackson, S. Kellas, Soft Soil Impact Testing and Simulation of Aerospace Structures, in: *10th Int. LS-DYNA User’s Conf.*, pp. 29–42 (2008)
 23. T. Belytschko, W. Liu, B. Moran, Nonlinear finite elements for continua and

structures (Wiley, 2000)

24. M.H. Ray, M. Mongiardini, C.A. Plaxio, M. Anghileri, NCHRP Web-Only Document 179: Procedures for Verification and Validation of Computer Simulations Used for Roadside Safety Applications (Transportation Research Board, 2010)
25. W.L. Oberkampf, M.F. Barone, Measures of agreement between computation and experiment: Validation metrics, *J. Comput. Phys.* **217** pp. 5–36 (2006). doi:10.1016/J.JCP.2006.03.037
26. M. Mongiardini, M.H. Ray, M. Anghileri, Development of a Software for the Comparison of Curves During the Verification and Validation of Numerical Models, in: 7th Eur. LS-DYNA Conf., (2009)