

doi:10.15199/48.2018.11.13

## A Set of Low-power Microcontroller-based Modules Used for Testing of Small Energy Measurement Methods

**Abstract.** Estimation of energy consumption of low-power devices is not widely discussed in the scientific literature, but this topic is getting more and more popular. Evaluation process of newly developed methods and instrumentation requires careful treatment. In order to fulfill this niche, the set of micro-power microcontroller based devices was proposed. The devices represent typical energy consumption profiles and allow experimental verification of newly developed methods for energy estimation.

**Streszczenie.** Estymacja poboru energii układów mikromocowych nie jest zbyt obszernie opisywana w literaturze, choć temat ten staje się coraz bardziej popularny. Testowanie metod i urządzeń pomiarowych małych energii wymaga zastosowania odpowiedniego podejścia, w tym celu zaproponowano i przebadano zestaw urządzeń reprezentujących typowe profile poboru energii i pozwalających praktycznie weryfikować metody estymacji poboru małych energii. (Zestaw niskomocowych układów mikrokontrolerowych do testowania metod pomiaru małych energii).

**Keywords:** Energy-harvesting, low-power microcontrollers, small energy measurement, current consumption profile.

**Słowa kluczowe:** pozyskiwanie energii z otoczenia, mikrokontrolery niskomocowe, pomiar małych energii, profil poboru prądu.

### Introduction

In recent years, we can observe continuously increasing demand for mobile devices and those working in places without access to conventional energy sources [1, 2]. Mostly, such kind devices use, as a power source, the built-in battery of cells or accumulators, so to extend the time of uninterrupted operation it is necessary to increase the capacity of the energy source and/or reduce the energy consumption of the device – by using low-power devices [3]. Another solution for power supply is to use alternative energy sources available in the environment - use of the "energy-harvesting" technique (EH) [4, 5]. Regardless of the chosen method for power supply, it is necessary to make an energy balance - a combination of the capacity of power supply on one side and the average and maximum energy consumption of the tested system or electronic device on the other side. The estimation of the actual parameters of both the energy source and the the energy consuming system is not an easy task. The difficulty is mainly due to the nature of energy consumption (current) by the micropower system: typically the system remains for most of the time (> 95%) in sleep mode, where the power consumption is at the level of several  $\mu\text{A}$ , waking up only periodically for a short time to perform measurements and recording or wireless transmission of their results. During activity, the current consumption increases significantly and reaches even tens of mA.

For accurate estimation of energy consumed by a typical low-power system, the measuring device must be characterized by a large dynamic range - it should be assumed that the measured currents can vary by several orders of magnitude.

### Methods of energy estimation consumed by low-power systems

First possible solution for small energy measurement is the one based on the energy definition:

$$(1) \quad E = \int_{t_b}^{t_e} u_s(t) \cdot i_s(t) dt$$

where:  $t_b$  - begin time,  $t_e$  - end time of energy measurement.

This method is most often implemented [7] in the system shown in Fig. 1, where the integration was carried out numerically in the control system, on the signals

proportional to voltage across  $U_{US}(t)$  and current through  $I_{IS}(t)$  the powered circuit, sampled by the ADCs.

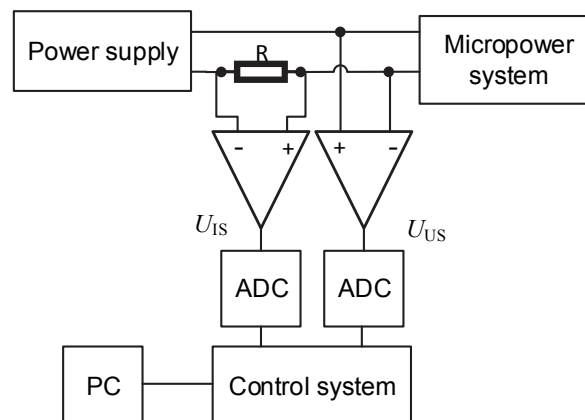

Fig. 1. Energy measurement method implementation using energy definition

The technical implementation of the above method presents a number of problems: high dynamics of changes in the value of current  $i_s(t)$  in the range from  $\mu\text{A}$  to several tens of mA, which requires the use of high resolution transducers, high sampling frequency requires high speed transducers, numerical integration errors become particularly important due to the relatively long times in which energy is measured.

Due to the above problems, alternative measurement methods are sought, based on the implementation of integration in an analog way, using current mirrors [8].

The measurement idea is based on the conversion of the measured current into a signal whose frequency depends on the current. This process is based on the conversion of current to voltage using a capacitor. The flowing current, providing the charge, increases the voltage on the capacitor, in proportion to the charge flowing over time. When the voltage on the capacitor reaches the appropriate level, the trigger is switched and the capacitor is discharged. Counting the pulses number at a given time, we can determine the average value of the current consumed by the powered system. This method is based on an assumption, that during the integration period, the supply voltage  $u_s(t)$  can be treated constant and equal to  $V_{cc}$ . In this case, the energy consumption is described by (2).

$$(2) \quad E = V_{cc} \cdot \int i_s(t) dt$$

The mentioned circuit is not able to measure the amount of energy generated by the EH source, because the measured current is flowing out of the system (delivered to the load). Another problem is related to the voltage drop (ca. 2V) caused by the current mirror.

An integrator based on an operational amplifier shown in [9] is eliminating the above mentioned disadvantages by using an additional voltage follower and a current source providing an initial polarization.

Another measurement method uses charge balancing [10]. On the measuring resistor there is a voltage drop proportional to the current flowing through the tested system. Then it is converted to current charging the integrator based on operational amplifier. When the voltage on the capacitor exceeds the reference level, the control system switches on the compensating current source for a specified time, which discharges the integrator. The output change informs about the measurement of the load portion.

A broader overview of micro-energy measurement methods is in [11]. The authors, when developing new methods and their practical implementations, often face the problem of assessing the obtained effects and the need to define a "test-engine", which allows to test the developed measuring instruments in conditions that are as close as possible to the target work environment. The implementation of model test systems has been planned [12], supplemented with a low energy sensor as well as a communication module (Bluetooth).

### Overview of selected low-power devices

Due to the aforementioned need to develop model of micropower systems that will be representative for this class of electronic devices and will serve as test objects for testing methods for energy estimation, the current offer of low-power microcontrollers by leading manufacturers and the evaluation boards were reviewed. Basing on energy

consumption, four microcontrollers were selected from leading manufactures offer.

STM32L031K6T6 is high-performance ARM® Cortex®-M0+ 32-bit RISC core [13], which can operate at 32 MHz clock. It has high-speed embedded memories plus an extensive range of enhanced I/Os and peripherals.

ATtiny21x/41x/81x is a family of 8-bit microcontrollers [14] from Atmel (currently Microchip). This tinyAVR® family expands the performance of the latest generation of AVR MCUs. tinyAVR devices offer an combination of miniaturization, processing power, analog performance and system-level integration. The tinyAVR MCU is the most compact, feature-rich device in the AVR family.

The PIC24F microcontroller family [15] is cost-effective. It has 16-bit MCU performance and many devices with Microchip's eXtreme Low Power Technology. The PIC24 Lite family (PIC24FXXKXXX) features the lowest cost and lowest power in small pin count options, with integrated EEPROM, op-amps, DACs, flexible PWMs and Configurable Logic Cell (CLC) for real-time logic control.

MSP432P401R is ARM® 32-Bit Cortex®-M4F CPU [16] with frequency up to 48 MHz, Floating-Point Unit and Memory Protection Unit. As an optimized wireless host MCU, the MSP432P401x allows developers to add high-precision analog and memory extension to applications based on SimpleLink wireless connectivity solutions.

Table 1 summarises typical parameters, including power consumption values in various operating modes (energy saving) for the above-mentioned microcontrollers.

Two microcontroller modules with comparable capabilities and a favorable price/performance ratio: NUCLEO-L031K6 and MSP432P401R LaunchPad™ were selected for further work.

The low power multiparameter sensor BME280 [17] was included in the selected low-power devices. It is a digital sensor equipped with an I<sup>2</sup>C interface. It allows to measure temperature, air humidity and atmospheric pressure. The sensor parameters are summarized in Table 2.

Table 1. Summary of parameters for selected low-power microcontrollers.

Microcontroller	STM32L031K6T6	ATtiny21x/41x/81x	PIC24FxxKLxxx	MSP432P401R
Data bus	32-bit	8-bit	16-bit	32-bit
Family	STM32L0	ATtiny	PIC24F	MSP432
Manufacturer	ST Microelectronics	Atmel/Microchip	Microchip	Texas Instruments
Power supply (min-max) [V]	1.65-3.6	1.8-5.5	1.8-3.6	1.62-3.7
Max. clock frequency [MHz]	32	20	32	48
Current in active mode [ $\mu$ A/MHz]	115	340	630	80
Current in sleep mode [ $\mu$ A/MHz]	25	180	40	0.66
Current in power-down mode [ $\mu$ A]	0.8	0.18	0.54	0.025
Price [zł]	from 10	from 5	from 11	from 15
Evaluation board	NUCLEO-L031K6 [13] (56zł)	ATtiny416-XNANO [14] (43zł)	PIC24F Curiosity Development Board DM240004 [15] (115zł)	MSP432P401R LaunchPad™ [16] (52zł)

Table 2. Electrical parameter of BME280 sensor [17].

Parameter	Test condition	Representative value	
working voltage	-	DC 2.0V~3.6V	not connected /connection
working current	master		21mA/9mA
		slave	8.5mA/9mA
	slave	MODE0	6 $\mu$ A~2.6mA /1.6mA
		MODE2	0.4 $\mu$ A/1.6mA

In order to send measurement data, the low-power Bluetooth module HC-08, operating in the 4.0 BLE

standard, is used. The current consumption declared by the manufacturer [18] is presented in Table 3.

Table 3. Electrical characteristics of HC-08 module.

Parameter	Typ	Max	Unit
Supply voltage	1.8	3.6	V
Sleep current	0.1	0.3	$\mu$ A
Standby current	0.2	0.5	$\mu$ A
Current during humidity measurement	340		$\mu$ A
Current during pressure measurement	714		$\mu$ A
Current during temperature measurement	350		$\mu$ A

## Low-power modules testing

For the low-power device, the classical block diagram presented in Fig. 2 was assumed. The device structure is typical for the sensor nodes in sensor networks.

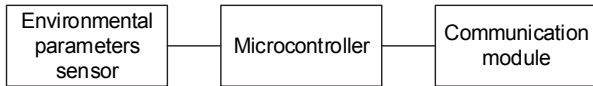

Fig.2. Block diagram of a low-power device

The main part of the device is low-power microcontroller: one of the previously discussed. The microcontroller communicates the sensor (BME280) via I<sup>2</sup>C to measure environmental parameters: temperature, humidity and pressure. Using Bluetooth module HC-08 microcontroller sends the data to master controller (not shown on the diagram) - in our experiments, the data was received by smartphone terminal, as shown in Fig. 3.

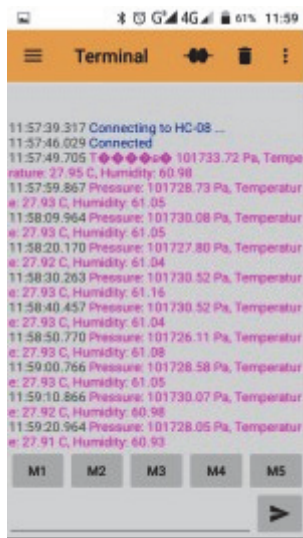

Fig.3. The data send from the low-power device

In order to check the real-life current consumption of the devices, each device was thoroughly examined using setup shown in Fig.4. The value of the resistor used for current sensing was changed depending on the measured current. The Tektronix TBS 1052 oscilloscope [19] was used to acquire and store the current consumption profiles of the tested devices. Each devices was tested separately to allow optimal current range selection and comfortable presentation on graphs.

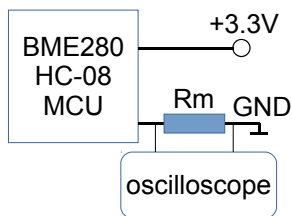

Fig.4. Measurement setup for current consumption profile acquisition

In the first step, the current consumption of the BME280 sensor was acquired using  $R_m$  resistor equal to  $10 \Omega$  and oscilloscope sensitivity equal to  $2mV/div$ , so the resulting sensitivity was  $200\mu A/div$  (Fig. 5).

Taking a look on the waveform presented in Fig. 5, three steps in current can be notice. The steps represent three phases of the sensor measurement: measuring

temperature, pressure and humidity. The current value read from the oscilloscope equal to  $380 \mu A$ ,  $780 \mu A$  and  $370 \mu A$  in those 3 phases respectively. The obtained values directly correspond to datasheet [17].

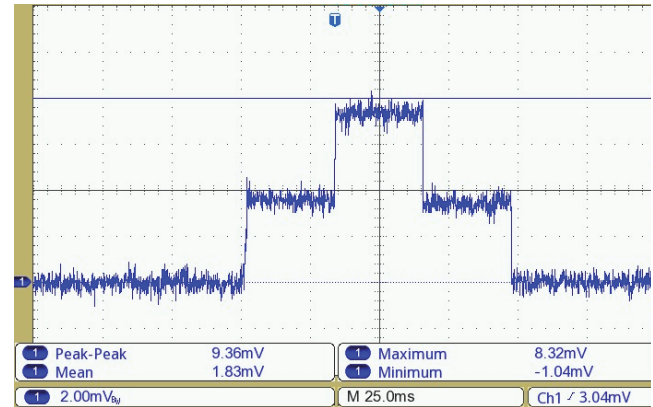

Fig.5. Current consumption profile for BME280 sensor

In the next step, the low-power microcontrollers were tested. All microcontrollers run the same program compiled with native toolchain provided with the development kit. As a reference, firstly, the STM32F031 kit was tested. This microcontroller isn't strictly low-power microcontroller, but the Authors have decided to include it to emphasise the differences. Figure 6 presents the current consumption profile for STM32F031 initialisation procedure.

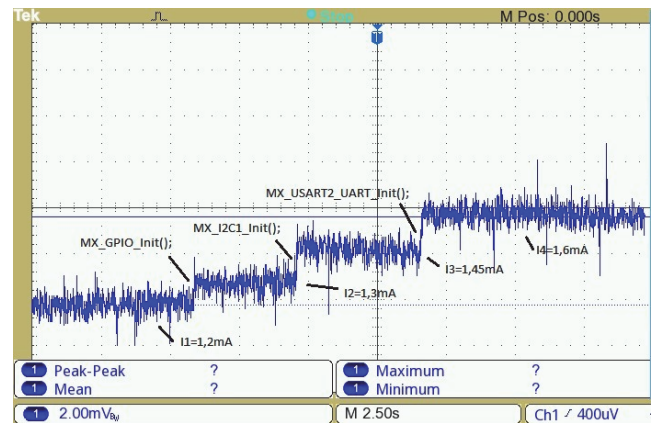

Fig.6. Current consumption profile for STM32F032 initialisation

Figure 7 presents the current consumption profile for STM32L031 based on the core optimised for low-power.

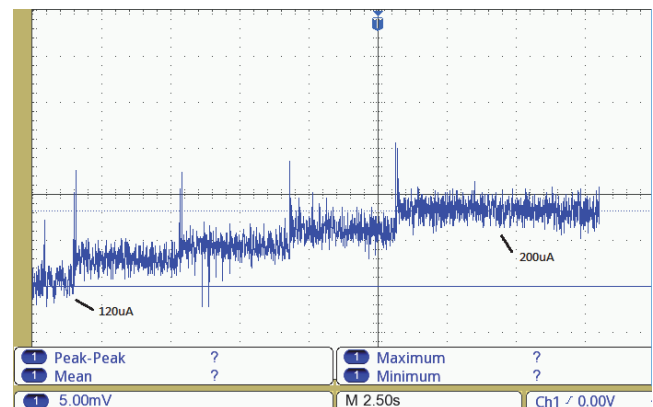

Fig.7. Current consumption profile for STM32L032 initialisation

The same software running on STM32F031 causes current consumption from 1.2 mA up to 1.6 mA, while STM32L031 requires only from 120  $\mu$ A to 200  $\mu$ A - the current consumption is 10 times smaller.

Figure 8 presents the current consumption profile for MSP432P401R microcontroller during normal run (after initialisation). The average current is on the level of 500  $\mu$ A.

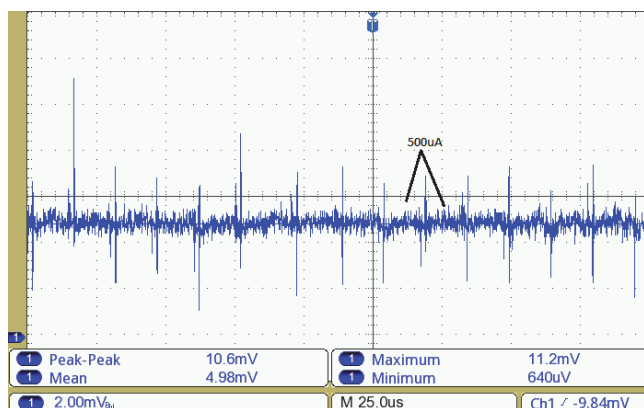

Fig.8. Current consumption profile for MSP432P401R normal run

In the last step, the Bluetooth module HC-08 was tested. The current consumption profile for MODE1 (energy-saving mode) and output power level set to 4dBm is shown in Fig.9.

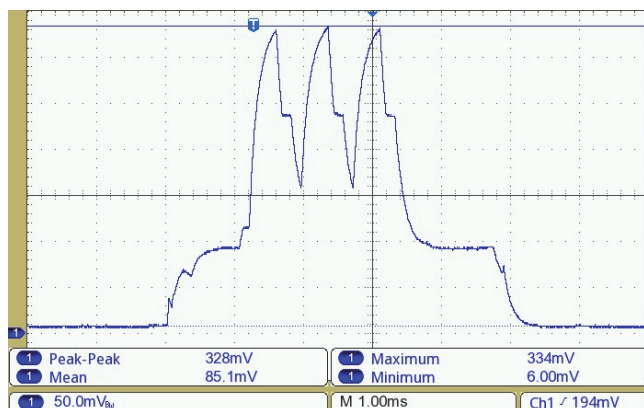

Fig.9. Current consumption profile for HC-08 Bluetooth module working in energy-saving MODE1 and 4 dBm output power during data transmission

In HC-08 current consumption profile, in the described mode, the three stages can be observed: firstly, the module is in sleep mode with very low consumption (on the level of a few  $\mu$ A), then, before sending, the module is waking up and the current is increased to 9 mA (standby current), finally, the transmit stage is entered and the current increases up to 34 mA. After transmission, the module returns at first to stand-by mode (9 mA) then to sleep-mode with  $\mu$ A-level currents. In MODE0 (normal one – the default state after power-on) the module doesn't enter sleep-mode, thus the HC-08 module continuously consumes ca. 9 mA which significantly increases overall current consumption.

### Conclusions

In the paper, we propose the set of three low-power components: multi-parameter sensor, low-power microcontrollers and low-power Bluetooth module which are used together as a low-power device. The device is

intended to be used as a "test engine" for evaluation of the small energy measurement methods. The components were thoroughly tested and their current consumption profiles were acquired for different settings allowing to design controlled current consumption for whole device. This leads to well-defined profile which will be used for testing newly developed measurement methods and instruments for estimation of small energy.

**Authors:** mgr inż. Dariusz Palmowski, e-mail: [palmowski@eti.pg.edu.pl](mailto:palmowski@eti.pg.edu.pl); dr hab. inż. Grzegorz Lentka, prof. nadzw. PG, e-mail: [lentka@eti.pg.edu.pl](mailto:lentka@eti.pg.edu.pl); Jerzy Rutkowski, e-mail: [jerrutko@student.pg.edu.pl](mailto:jerrutko@student.pg.edu.pl); Gdansk University of Technology, Faculty of Electronics, Telecommunications and Informatics, Department of Metrology and Optoelectronics, ul. Narutowicza 11/12, 80-233 Gdańsk.

### REFERENCES

- [1] Yao-Chin W., Nan-Chun L., Bor-Shyh L., A wireless and wearable measurement system for human body electrostatic monitoring application, *Measurement*, Vol. 117 (2018), 365-370
- [2] Gunawardena N., Pardyjak E. R., Stoll R., Khadka A., Development and evaluation of an open-source, low-cost distributed sensor network for environmental monitoring applications, *Meas. Sci. Technol.*, Vol. 29 (2018), No 2
- [3] Beeby S., White N., Energy Harvesting for Autonomous Systems, *Artech House* (2010)
- [4] Edwards R., Gould C., Review on Micro-Energy Harvesting Technologies, *Power Engineering Conference (UPEC)* (2016)
- [5] Tyborczyk S., Modułowy system pomiarowo-sterujący z komunikacją GSM, Praca dyplomowa, Politechnika Gdańska Wydział Elektroniki, Telekomunikacji i Informatyki (2014)
- [6] Lentka G., Tyborczyk S., Distributed measurement system with data transmission secured using XXTEA algorithm, *Przegląd Elektrotechniczny*, No. 10/2016 (2016), 266-269
- [7] Jiang X., Dutta P., Culler D., Stoica I., Micro Power Meter for Energy Monitoring of Wireless Sensor Networks at Scale, *IPSN'07*, April 25-27, 2007, Cambridge, Massachusetts, USA
- [8] Konstantakos, V., Kosmatopoulos, K., Nikolaidis, S., Laopoulos, T., Measurement of Power Consumption in Digital Systems, *IEEE Transactions on Instrumentation and Measurement*, Vol.55 (2006), No.5,
- [9] Lentka G., Palmowski D., Hojka A., Energy consumption estimation of low-power devices using an integrating coulombmeter, *Przegląd Elektrotechniczny*, No 12/2016 (2016), 209-212
- [10] Lentka G., Palmowski D., Hojka A., On the use of a charge balancing method for low energy measurements, *Przegląd Elektrotechniczny*, No 10/2017 (2017), 77-80
- [11] Palmowski D., Lentka G., Hojka A., Przegląd metod pomiaru małych energii dla oceny układów „Energy-Harvesting” i systemów mikromocowych, *Zeszyty Naukowe Wydziału Elektrotechniki i Automatyki Politechniki Gdańskiej*, nr. 51 (2016), 139-142
- [12] Palmowski D., Lentka G., Rutkowski J: Mikromocowe układy mikrokontrolerowe jako narzędzie badania metod pomiaru małych energii, *XII Konferencja Naukowa, Systemy Pomiarowe w Badaniach Naukowych i w Przemysle* (2018), 111-114
- [13] ST Microelectronics, UM1956: User manual for STM32 Nucleo-32 board (2016)
- [14] Microchip, ATtiny416 Xplained Nano – User guide (2017)
- [15] Microchip, PIC24F Curiosity Development Board - Quick Start Guide (2016)
- [16] Texas Instruments, MSP432P401R SimpleLink™ Microcontroller LaunchPad™ Dev. Kit User's Guide (2018)
- [17] Bosch: BME280 datasheet - [https://ae-bst.resource.bosch.com/media/\\_tech/media/datasheets/BST-BME280\\_DS001-12.pdf](https://ae-bst.resource.bosch.com/media/_tech/media/datasheets/BST-BME280_DS001-12.pdf)
- [18] HC08 User Manual - [https://shop.idealtec.com/wp-content/uploads/2018/05/HC-08A-datasheet-www.idealtec.com\\_.pdf](https://shop.idealtec.com/wp-content/uploads/2018/05/HC-08A-datasheet-www.idealtec.com_.pdf)
- [19] Tektronix TBS 1052B-EDU DataSheet: <https://www.tek.com/datasheet/digital-storage-oscilloscope-0>