

# Application of the Barkhausen effect probe with adjustable magnetic field direction for stress state determination in the P91 steel pipe

Marek Chmielewski, Leszek Piotrowski\*

The paper presents the results of application of a novel Barkhausen effect (BE) probe with adjustable magnetizing field direction for the stress level evaluation in ferromagnetic materials. The investigated sample was in a form of a pipe, made of P91 steel that was anisotropic due to the production process. The measurements were performed before and after welding, revealing the influence of welding process on the residual stress distribution. As was observed, the process introduced high tensile stresses in the normal to the weld direction (which can be interpreted as a decrease of strongly compressive residual stresses present in martensitic steels). In addition to that, the paper presents investigations of the measurement set performance corroborating its applicability for Barkhausen effect signal measurements in the magnetically anisotropic materials. The signals obtained during manual rotation of the probe (typical method of BE measurements) are very similar to those recorded during automatic field axis rotation.

**Key words:** Barkhausen effect, stress evaluation, magnetic anisotropy

## 1 Introduction

The measurement of magnetic properties angular distribution is an ever important issue in the field of non-destructive evaluation of industrial components made of ferromagnetic steels. The variety of possible angular distributions in the investigated materials, due to its direct relation with mechanical and physical properties, gives a very important information about the state of investigated material and its determination is a very important metrological issue. One of the most effective methods of magnetic anisotropy determination seems to be the measurement of the Barkhausen noise (BN) intensity. The key to its applicability is the direct dependence of the BN intensity on the magnetic hysteresis loop properties. In addition to that, the non-destructive character of the BN signal intensity measurements makes this method one of the most important techniques of material evaluation that can be applied in the industrial environment. The only problem with the anisotropy determination procedure is the necessity to perform an appropriate number (the better the required precision the higher the number of measurements) of BN signal intensity measurements for various magnetizing field directions [1,2]. In order to facilitate and speed-up such process we propose application of an automated device, equipped with the probe containing two perpendicular electromagnets. By the change of the intensity of magnetizing currents in both electromagnets one can obtain an arbitrarily chosen direction of magnetizing field. In the paper we present the details of the mentioned device and discuss the procedure of stress anisotropy determination.

The main objective of projected devices is full automation of measurement of the angular distribution of

the intensity of the Barkhausen effect. This goal can be achieved thanks to the unique properties of the device, presented below. There are two main blocks of the properties. Generator module: arbitrarily chosen time dependence of the magnetizing current, wide frequency range (magnetizing current slopes), arbitrarily chosen angular step (no lower limit), automatic or dedicated change of the magnetizing current amplitudes. Detection unit: digital filtering - Fast Fourier Transform (FFT), automatic determination of signal amplitude and intensity - as the intensity we treat the area under the BN signal envelope, magnetic hysteresis loop determination for both magnetizing yokes, determination of angular distribution of the BN signal, determination of the main axes of magnetic anisotropy (fitting), complete recording of the measured signals.

All of this points have an impact on the construction of the measurement system.

## 2 Measurement set

System for the magnetic properties anisotropy determination is based on the original design of the magnetizing set consisting of two orthogonal electromagnets that can be fully controlled with the help of the dedicated, LabVIEW based, software. The magnetizing field thus obtained can have any direction, as well as an arbitrarily chosen time dependency (the typical is the triangular waveform). The magnetizing yokes are made of Permalloy sheets (thickness  $h = 0.5$  mm) stacked in the form of C-yokes of the square cross section (10mm x 10mm). The yokes are mounted together, perpendicularly, on the common symmetry axis. The mounting is designed in such a

---

\* Gdansk University of Technology, ul. Gabriela Narutowicza 11/12 80-233 Gdansk, Polska bzyk@pg.gda.pl, lesio@mif.pg.gda.pl

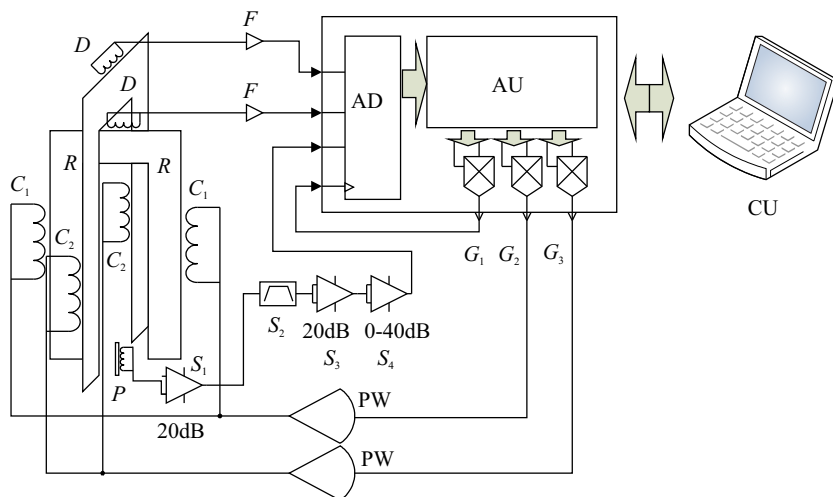

**Fig. 1.** Block diagram of the devices. description of all blocks in the document. *R* – magnetizing cores; *D* – coils of the magnetic flux control; *C*<sub>1</sub>, *C*<sub>2</sub> – magnetizing coils; *P* – detecting coil of the barkhausen effect; *S*<sub>1</sub> – preamplifier integrated with the measuring head; *S*<sub>2</sub> – bandpass filter; *S*<sub>3</sub> 20 db amplifier; *S*<sub>4</sub> adjustable signal amplifier(0-40 db); *F* – signal amplifiers of the changes of the magnetic flux; *PW* – current power amplifiers; *G*<sub>1</sub> – strobe signal generator; *G*<sub>2</sub>, *G*<sub>3</sub> – magnetizing signal generators; *AD* – analog to digital converter; *AU* – digital to analog, analog to digital control system; *CU*–PC with a dedicated software

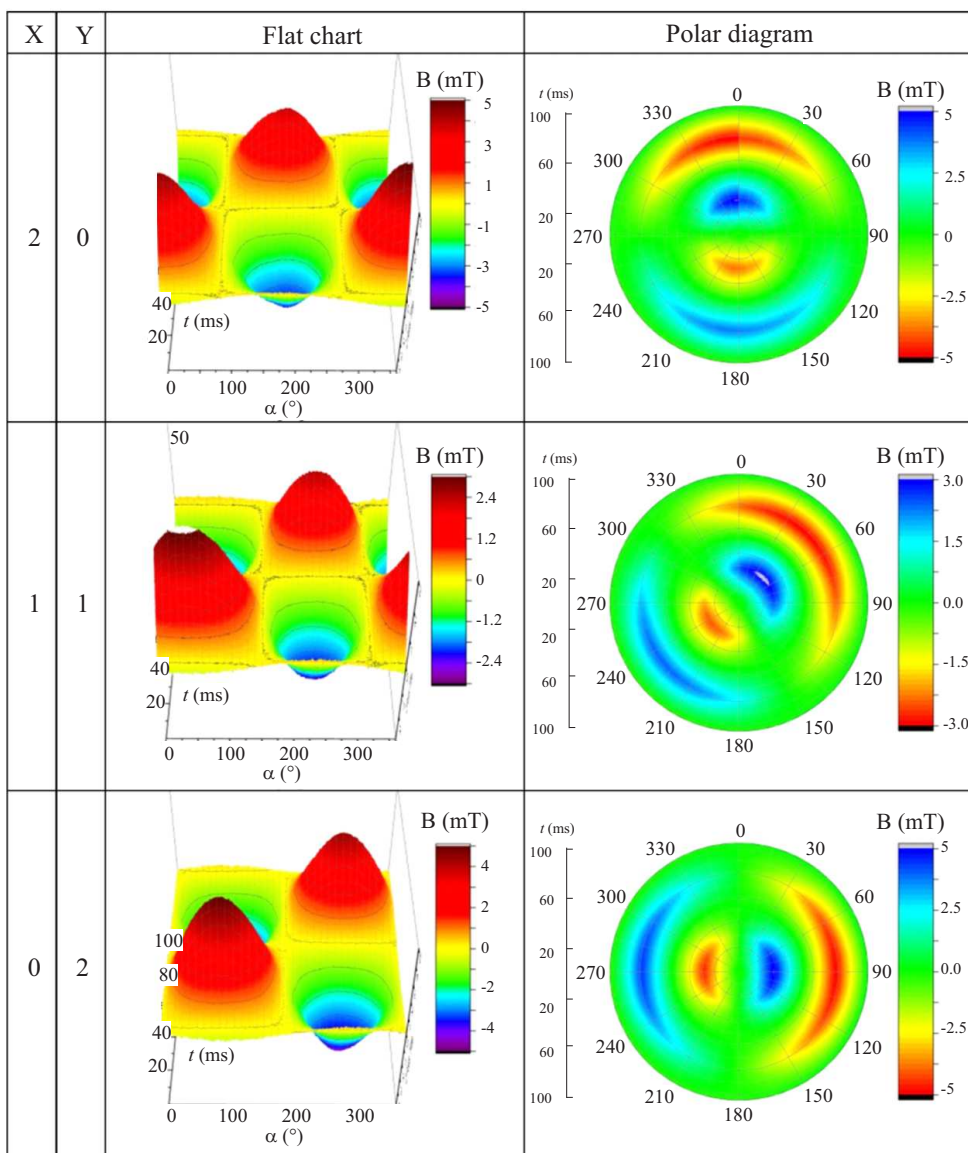

**Fig. 2.** Angular distribution of the magnetic field for five different settings of amplitudes(x,y)of the digital generators

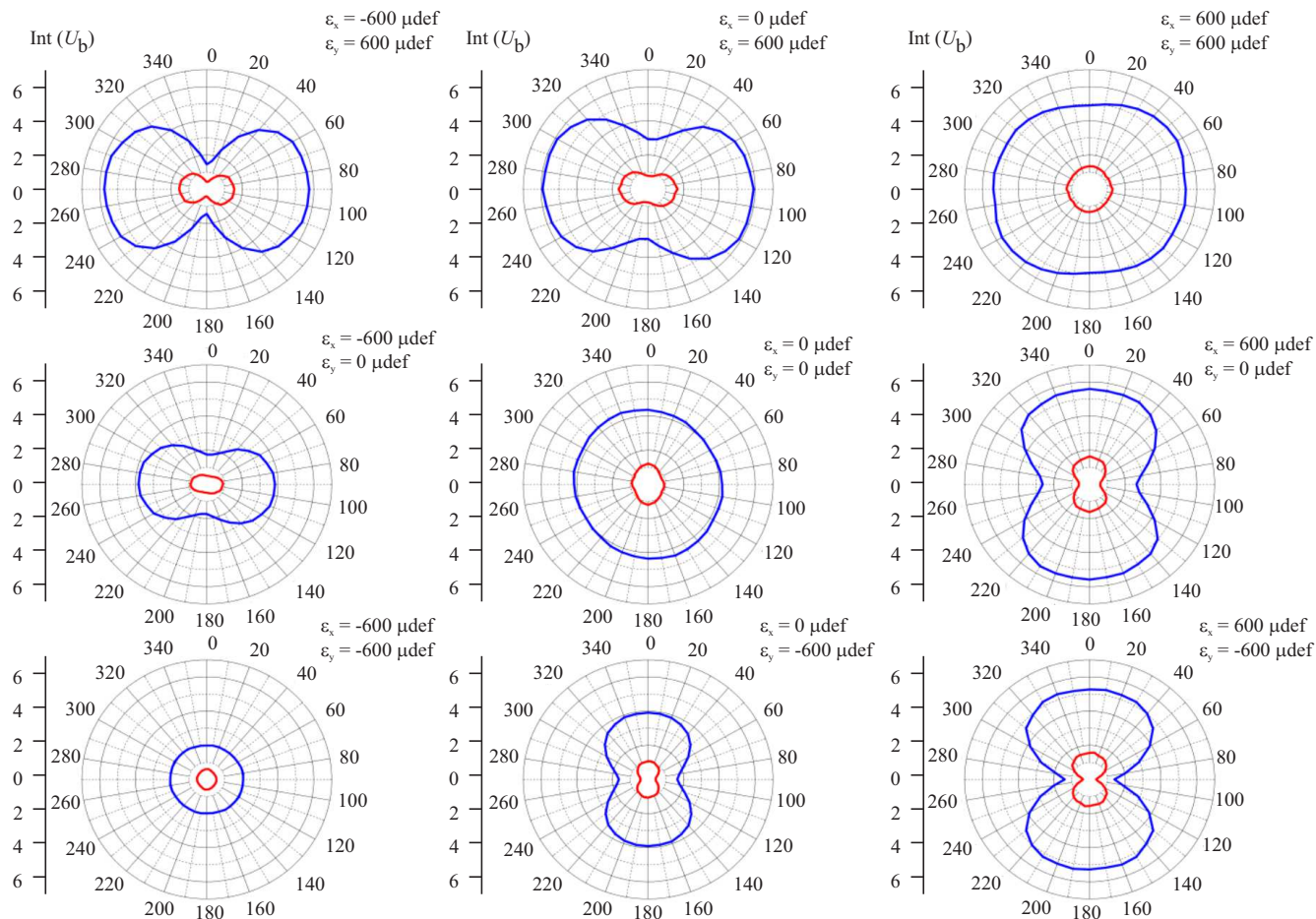

**Fig. 3.** Angular distribution of BN intensity for anisotropic duplex steel(blue)and isotropic steel(red)for bidirectional deformation calibration

way that it enables independent movement of the yokes (along the axis). Such a design, together with the application of independently mounted detecting coil with the movable ferrite core, allows for the measurements on the surfaces with a very strong curvature. Each of the magnetizing yokes is equipped with an additional control coil that can record the changes in the magnetic flux inside the core. This additional level of control can be used for the verification of the probe adjustment independent of BN intensity. The information can also be used for the monitoring of the changes in magnetic flux density resulting from the evolution of the magnetic properties of the investigated material, or as a feedback signal for the magnetizing current modification. The probe is connected to the central unit which in turn is controlled by a standard PC (industrial notebook in our case) on which the dedicated control software written in LabVIEW environment is installed. Thanks to the implementation of a fast, multi channel, high definition measurement card made by National Instruments, the quantity of analog components in the measurement and control circuits is minimized. Fig.1 presents functional block diagram of the devices.

During the tests of the performance of the presented device a triangular waveform was chosen. Such a wave-

form was fed to current amplifiers and as a result a fully controlled distribution of the magnetizing field was obtained. The direction and intensity of the obtained magnetic field was verified with the help of the magnetic induction measurements with the help of the rotating Hall probe. The Hall sensor was placed in the central part of the probe (for the test purposes the probe was placed on a wooden plate in which the hole for the Hall probe was drilled), right beneath the detecting coil. After the completion of such procedure the appropriate amplitudes of the magnetizing current, necessary for the proper rotation of magnetizing field, were determined. In the Fig.2 there are shown examples of the magnetizing currents for both electromagnets and resulting from such combination angular distributions of magnetic field induction (as measured by the aforementioned rotating Hall probe).

As it is known, the BN intensity is dependent on various physical properties of the investigated materials. Its applicability was proven suitable for: microstructure features determination, detection of texture, stress level assessment [3]. Practical application of the BN technique requires however the prior calibration to determine the relation between the interesting parameter/feature and the BN intensity. In the case of stress level determination, due to the fact that the BN signal is detected only

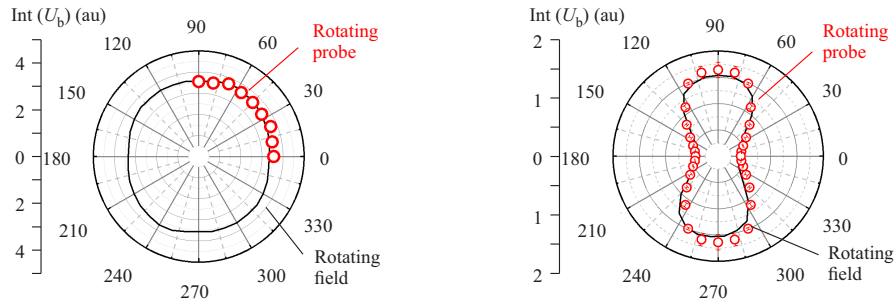

Fig. 4. The results of the measurements of the angular distribution of the BN signal intensity obtained with the motionless electromagnets for a) isotropic (magnetically) material, b) anisotropic material

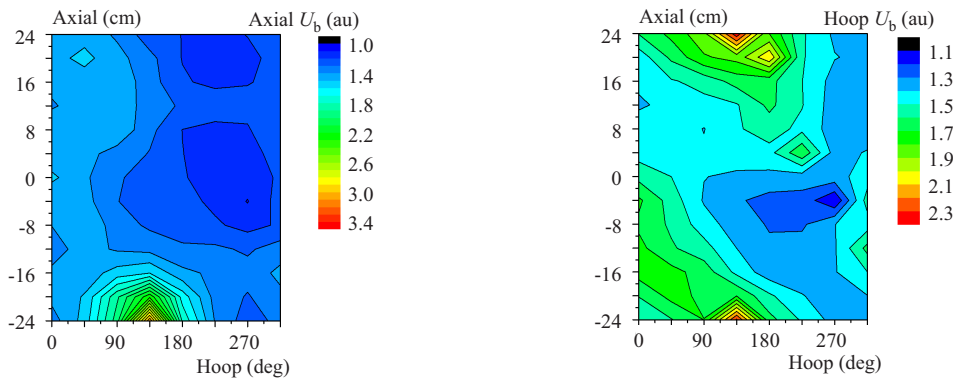

Fig. 5. Distribution of the BN signal intensity for two main directions (axial and hoop) as delivered sample

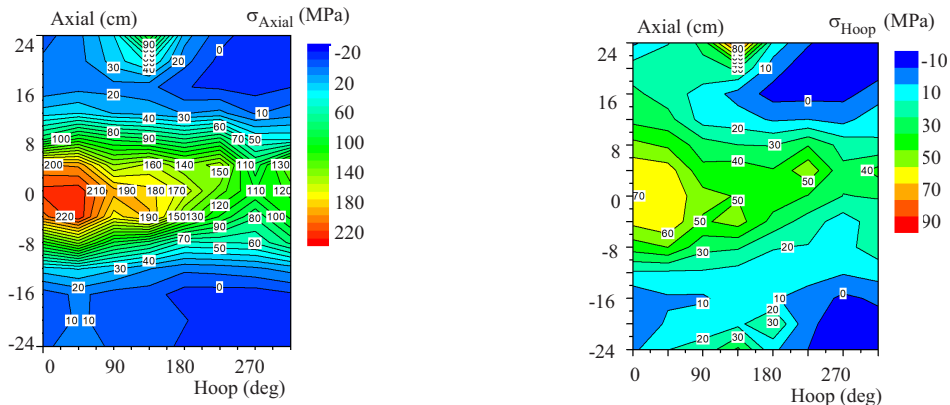

Fig. 6. Stress distribution for two directions (axial and hoop) for the welded pipe

from the close to surface (up to about 0.1 - 1 mm), the bending of the sample can be applied for the calibration purposes.

To obtain unambiguous information about the stress level inside the material the biaxial stress calibration was performed with the help of the cross shaped sample. The deformation level was controlled with three-axial tensometric rosette (the same as used in the hole drilling method of stress level determination).

For the procedure to be reliable the physical properties of the calibrating samples should be as homogeneous as possible. In practice it is rarely so and thus the calibrating procedures should be performed for possibly wide spectrum of physical parameters and for various types of materials.

In addition to that, taking into account present state of knowledge as regards the BN measurement application, complementary measurements with the help of other measurement techniques are highly recommended [4]. Such measurements should allow to compare and verify the physical properties as determined by various methods. Presently the main practical application of the BN measurements is the determination of the deformation level in the material and on its basis calculation of the stress distribution. The presented device has been successfully applied for the stress level determination in the flat plates made of ferromagnetic steels used in the industry, also in the case of high anisotropy materials (duplex steels). Figure 3 presents some of the BN signal calibration measurement performed on two kinds of ferrite materials.

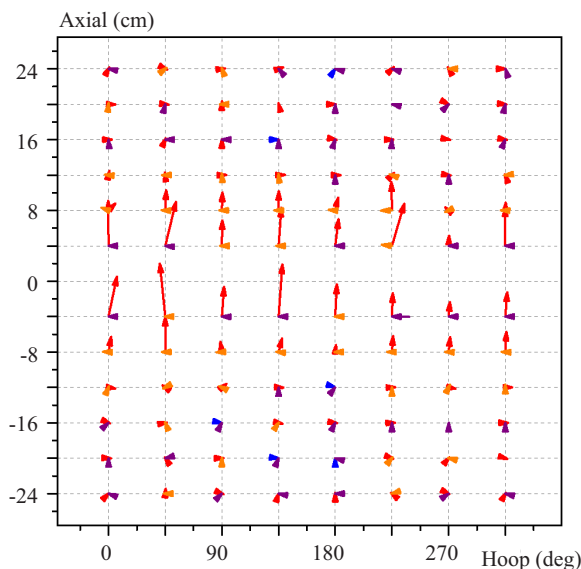

Fig. 7. Vector plot of the main stresses distribution for the welded pipe

An important issue that may be used as a measure of the apparatus applicability is the conformity of the BE signal intensity measured with the adjustable field direction (two perpendicular motionless electromagnets) and the BE intensity obtained with the help of a single, manually rotated electromagnet. The adequate comparative tests were performed and the results are presented in Fig. 4. Both results are in a good agreement what confirms the validity of the approach based on changing the magnetisation direction with the help of two electromagnets.

#### 4 Results of measurement and stress calculations for the P91 steel pipe

The investigated material was a pipe fragment, made of P91 martensitic steel. At the initial stage the BN signal intensity distribution over the outer surface of the pipe was measured (with the help of the probe with adjustable field direction). The dimensions of the pipe were as follows: length  $l = 500$  mm, outer diameter  $d = 200$  mm, wall thickness  $h = 12$  mm. The measurement grid dimensions were approximately 40mm x 40mm. The results of the BN signal intensity distribution measurements for two axes (hoop and longitudinal directions) are shown in Fig. 5.

In the next stage the pipe was cut in half (perpendicularly to its axis) and the obtained parts were welded together (no stress relieving heat treatment was applied). On the obtained sample the BN signal distribution measurements were repeated. With the help of the calibrating procedure results and after application of the computational procedure (taking into account tensor description of stress) described in detail in [5] the influence of the welding procedure on the stress distribution was assessed (it was the difference between the results obtained before and after welding). Fig. 6 shows the stress components

distribution (axial and hoop) and Fig. 7 presents the results in a vector form which shows not only the values of main stresses (unit length in the plot corresponds to 200MPa) but also their direction. One can observe the appearance of a strong tensile stress component in the direction almost perpendicular to the weld seam (axial).

#### 5 Conclusions

The measurement system for the automated determination of the angular distribution of the BE signal intensity turned out to be a very effective tool for the characterisation of the magnetic anisotropy (either intrinsic or stress induced). Application of an adequate calibration procedure allows for the determination of the main stress components distribution. In addition to that it proved to be useful for the non-destructive investigation of industrial components.

#### REFERENCES

- [1] L. Piotrowski, B. Augustyniak, M. Chmielewski and I. Tomas, "The influence of plastic deformation on the magnetoelastic properties of the CSN12021 grade steel", *J. Magn. Magn. Mater.*, vol. 321 pp. 2331-2335, (2009).
- [2] O. Stupakov, T. Uchimoto and T. Takagi, "Magnetic anisotropy of plastically deformed low-carbon steel", *J. Phys. D: Appl. Phys.*, vol. 43 195003 (7p), (2010).
- [3] C. Gatelier-Rothea, J. Chicois, R. Fougeres and P. Fleischmann, "Characterization of pure iron and (130 ppm) carbon-iron binary alloy by Barkhausen noise measurements: study of the influence of stress and microstructure", *Original Research Article Acta Materialia*, vol. 46, no. 14, pp. 4873-4882, (1998).
- [4] D. C. Jiles, P. Garikepati and D. D. Palmer, "Evaluation of residual stress 300M steels using magnetization, Barkhausen effect and X-ray diffraction techniques", *NDT & E International*, vol. 29, no. 5, p. 343, (1996).
- [5] M. Chmielewski, L. Piotrowski and B. Augustyniak, "A fast procedure of stress state evaluation magnetically anisotropic steels with the help of a probe with adjustable magnetizing field direction", *Measurement, Science and Technology*, vol. 28, 045903 (11p), (2017).

Received 13 February 2018

**Marek Chmielewski** (Eng PhD) was born in Gdansk in 1967. He graduated from the Faculty of Applied Physics and Mathematics at Gdansk University of Technology in 1992 and obtained his PhD title in 2000. He works as a researcher at the Solid State Department, Faculty of Applied Physics and Mathematics. His area of interest is measurement techniques development and application in nondestructive testing (especially the measurement of magnetoelastic properties and Barkhausen effect).

**Leszek Piotrowski** (Eng DSc) was born in Koszalin in 1974. He graduated from the Faculty of Applied Physics and Mathematics at Gdansk University of Technology in 1999 and obtained his PhD title in 2004. He works as a researcher at the Solid State Department. His area of interest is magnetic nondestructive testing (especially the application of magnetoacoustic emission and Barkhausen effect).