

# THE INFLUENCE OF WATER AND MINERAL OIL ON VOLUMETRIC LOSSES IN THE DISPLACEMENT PUMP FOR OFFSHORE AND MARINE APPLICATIONS

Paweł Śliwiński

Gdańsk University of Technology, Poland

## ABSTRACT

*In this paper, volumetric losses in a positive displacement pump supplied with water and mineral oil are described and compared. The experimental tests were conducted using a prototype of a satellite pump (with a non-circular tooth working mechanism). In this paper, the sources of volumetric losses in this pump are characterized. On this basis, a mathematical model of these losses has been presented. The results of the calculation of volumetric losses according to the model are compared with the results of the experiment. Experimental studies have shown that the volumetric losses in the water pump are even 3.2 times greater than the volumetric losses in the oil pump. It has been demonstrated that the mathematical model describing the volumetric losses both in the water pump and in the oil pump is quite good. It has been found that the results from the loaded pump simulation (at  $\Delta p=25\text{MPa}$  and ant  $n=1500\text{rpm}$ ) differ from the results of the experiment by no more than 5% both for oil and water.*

**Keywords:** volumetric losses, satellite pump, water, oil

## INTRODUCTION

A pump is the most important element in a hydraulic system [3-10,17,18,20,22]. Its purpose is to convert mechanical energy into hydraulic energy. The energy carrier in hydraulic systems is a liquid. The type of liquid is determined by the requirements for the system. The liquid commonly used in hydraulic systems is mineral oil. However, in some industrial sectors, the requirement is a non-flammable (mining, steel mills, etc.) or non-toxic (food industry) liquid. In such a case, non-flammable synthetic liquids, water or water-based liquids (i.e. HFA-E emulsion) are used instead of mineral oil [21,32]. Water is a liquid which is non-flammable, non-toxic and certainly suitable for energy transfer in hydraulic systems. In comparison to mineral oil, water has a very low viscosity and low lubricating properties [15]. These parameters have a significant impact on the size of mechanical, volumetric and pressure losses in hydraulic machines [22]. These losses have an impact on the energy conversion efficiency in these machines and have an impact

on the noise [16,19,21,29,30,31,34]. Furthermore, the design parameters of hydraulic components have an influence on energy conversion efficiency [13,14,20,29,32].

Generally, each hydraulic device is dedicated to a specific type of working liquid. For example, a positive displacement pump dedicated to oil systems should not be used in systems where the working medium is water.

There is a growing trend in the world towards research and development of components and hydraulic systems supplied with water [2,3,13,14,21,32].

Studies of hydraulic systems, where water is the working medium, are especially important in marine technology. In offshore technology and marine applications, hydraulic power circuits are used frequently and water is generally available as a working liquid [2]. Thus, in order to eliminate the pollution of the environment and marine waters, it seems reasonable and justified to eliminate oil systems and replace them with water systems. To this end, it is necessary to develop and test innovative components for hydraulic water systems [20-25]. Thus, it was reasonable to develop a new positive displacement water pump called the satellite pump and mark it with the

PSM symbol. The pump contains an innovative operating mechanism consisting of non-circular gears [20,22-26]. The construction of this pump is described in the next section. The PSM pump can be used in a small portable power pack supplying various onboard devices on ships, rescue devices or hydraulic hand tools.

The development of the PSM pump enabled an investigation of the influence of the working liquid type (that is water and oil) on the energy losses that occur in this pump. This article is limited to the description of volumetric losses.

The impact of the type of liquid on volumetric losses in positive displacement pumps has not yet been analyzed by other researchers. In the literature, the volumetric losses in displacement machines have been describe in general, without specifying the type of clearances [1,19].

The first information about the impact of water and oil on volumetric losses in displacement machine are given in [25,28]. The biggest influence on the volumetric losses in hydraulic displacement machines has a leakage in the clearances of working mechanism [20,26,34]. It has been proved that in a displacement machine working mechanism clearances, not-fully developed turbulent flow takes place. This is particularly well visible in the case of using low viscosity liquid as a working medium [26]. Besides, in a displacement machine, there are other sources of volumetric losses, in addition to the clearances. The sources of these losses are described later in this article.

Therefore, the influence of the type of liquid on volumetric losses in a positive displacement pump is a new issue. It is cognitive and it represents an important scientific problem. Consequently, the following objectives have been defined for this article:

- indication and description of the sources of volumetric losses in a satellite pump;
- definition of the mathematical model of volumetric losses in pump working with mineral oil and with water;
- comparison of volumetric losses in a pump supplied with mineral oil and water;
- comparison of results of experimental research with the mathematical model.

## SATELLITE PUMP

The experimental research on the influence of the type of liquid on volumetric losses was carried out using a prototype of a positive displacement pump that was developed by the author. For experimental tests, a prototype of a satellite pump was selected and marked with the symbol PSM-0,75 (Fig. 1). The design of this pump is presented in Fig. 2. The working mechanism of the satellite pump is a specific gear mechanism in which the rotor rotates around the shaft axis and the revolving motion is done by satellites which are in gear with the stator and the rotor (Fig. 3).



Fig.1. General view of PSM-0,75 pump [27]

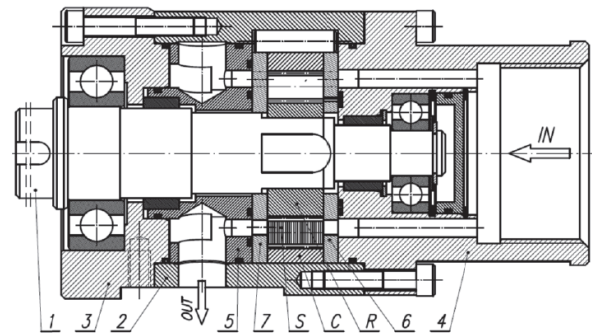

Fig.2. Axial cross section of PSM-0,75 pump [25,27]: C – curvature, S – satellite, R – rotor, 1 – shaft, 2 – casing, 3 – front casing, 4 – rear casing (suction manifold), 5 – pressure manifold, 6 and 7 – compensation (commutation) plates

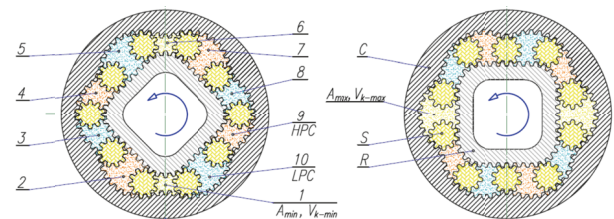

Fig.3. The working mechanism of a satellite pump [20,22-28]: C – curvature, R – rotor, S – satellite, 1÷10 – working chambers, LPC – low pressure working chamber, HPC – high pressure working chamber,  $V_{k-min}$  – working chamber with minimum area  $A_{min}$  (dead chamber),  $V_{k-max}$  – working chamber with maximum area  $A_{max}$

The toothed unit, shown in Fig. 3, is the satellite working mechanism of the pump. It consists of a toothed rotor R (4 humps), toothed curvature C (6 humps) and ten wheels S (satellite).

The principle of operation of the satellite mechanism is that when the rotor rotates, the volume of the space between the satellites changes. This space forms the working chamber. When its volume increases, the filling cycle takes place. Conversely, when its volume decreases, the emptying cycle occurs. Twenty-four cycles correspond to one shaft revolution. The chambers in the satellite mechanism are closed by commutation plates (Fig. 2 – elements 6 and 7, Fig. 4), which also play the role of compensation plates. Thus, the satellite pump has the ability to compensate axial clearances of the rotor and the satellites [20,22-28].



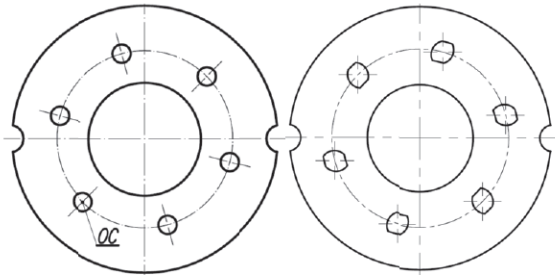

Fig. 4. High pressure commutation plate (left) and suction commutation plate (right) [20,22-28]

Experimental studies of the pump PSM-0,75/15 were carried out using the following liquids:

- the Total Azolla 46 oil (parameters in temp. 43°C: kinematic viscosity  $\nu=40\text{cSt}$ , density  $\rho=873\text{kg/m}^3$ , dynamic viscosity  $\mu=35\text{mPas}$ );
- tap water (parameters in temp. 27°C:  $\nu=0,85\text{cSt}$ ,  $\rho=996\text{kg/m}^3$ ).

The tested pump was characterized by the following parameters:

- theoretical displacement  $q_t=18,63\text{ cm}^3/\text{rev}$ ;
- teeth module  $m=0,75\text{mm}$ ;
- height of working mechanism  $H=15\text{mm}$ .

In hydraulic systems, a fixed displacement pump driven by an electric motor with a frequency converter is being used increasingly. This solution is also possible on ships. Thus, the desired pump capacity is achieved by changing its rotational speed. Therefore, it was necessary to conduct experimental tests of the pump in a wide range of rotational speeds.

## TEST STAND

The PSM pump was tested on the test stand with power recuperation. The diagram of the measurement system of this test stand is shown in Fig. 5. The test stand enables testing of the pump in a wide range of rotational speed (from 30 to 1500 rpm).

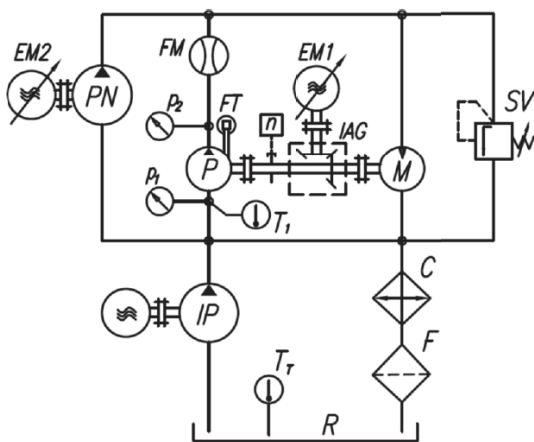

Fig. 5. The diagram of the measurement system of the test stand [27]: P – tested pump, M – hydraulic motor, PN – pump for fill the leaks in P and M, IP – impeller pump (pre-supply pump), SV – safety valve, C – cooler, F – filter, R – reservoir, IAG – intersecting axis gear, EM1 and EM2 – electric motors with frequency converters, other designations – description in the text below

During the test of the pump the following parameters were measured:

- pressure  $p_1$  in suction port (strain gauge pressure transducer, range  $-1\div+3\text{ bar}$ , accuracy 0,3%);
- the pressure  $p_2$  in pumping port (strain gauge pressure transducers, range  $0\div25\text{ bars}$  and  $0\div250\text{ bars}$ , accuracy 0,3%);
- the pump delivery  $Q$  (mass flow meter FM, range  $0\div33\text{ l/min}$ , class 0,1);
- the torque  $M$  (strain gauge force transducer FT mounted on the arm 0,5m (arm attached to the pump body), range  $0\div100\text{N}$ , class 0,1);
- the rotational speed of shaft  $n$  [rpm] (inductive sensor, the accuracy of measurement  $\pm 1\text{rpm}$ );
- the temperature  $T_1$  of liquid in the suction port of the pump (RTD temperature sensor, class A, max. measurement error 0,5°C). The temperature of liquid was stabilized (for oil  $T_1=43\pm 2\text{ }^\circ\text{C}$ , for water  $T_1=27\pm 2\text{ }^\circ\text{C}$ ).

## PRESSURE DROP IN INTERNAL CHANNELS

The volumetric losses depend on the pressure increase  $\Delta p_i$  in the working chambers of the pump. This pressure is difficult to measure. On the other hand, it is easy to measure the pressure increase  $\Delta p$  in the pump ports. The relationship between  $\Delta p$  and  $\Delta p_i$  is as follows:

$$\Delta p_i = \Delta p - \Delta p_{ich} \quad (1)$$

where  $\Delta p_{ich}$  is the pressure drop in internal channels of the pump. The methodology of measuring  $\Delta p_{ich}$  is described in [23].

The internal channels have a complicated geometry. The non-fully developed turbulent flow takes place in these channels. Therefore, to describe  $\Delta p_{ich}$ , it is proposed to adopt the following simplified relationship [23]:

$$\Delta p_{ich} = C_t \cdot \rho \cdot Q^2 + C_l \cdot \mu \cdot Q \quad (2)$$

where  $C_1$  and  $C_t$  are coefficients that are mainly dependent on the geometrical dimensions of the internal channel. The values of these coefficients are calculated from experimental data.

## SOURCES OF VOLUMETRIC LOSSES

The volumetric losses  $Q_{vl}$  in a displacement pump are calculated on the base of experimental data using the following formula:

$$Q_{vl} = q \cdot n - Q \quad (3)$$

where:

$Q$  – effective flow of pump;

q – theoretical pump displacement;  
n – pump input shaft speed.

In a satellite pump the sources of volumetric losses are:

- the liquid flow rate in flat clearances in satellite mechanism (Fig. 6);
- the liquid flow rate in the spaces between the teeth of the working mechanism (tip clearances  $T_c$  and backlashes  $G$ ) (Fig. 7);
- the liquid flow rate in clearances in commutation unit (short clearances) in satellite mechanism (Fig. 8);
- the liquid flow rate caused by the cyclic elastic deformation of the working chambers, mainly due to the cyclic deformation of the stator as the element with the smallest stiffness;
- the liquid flow rate depending on its compressibility;
- external leakage.

In the satellite pump, the leakage  $Q_{Lfg}$  is drained to the shaft chamber (Fig. 6).

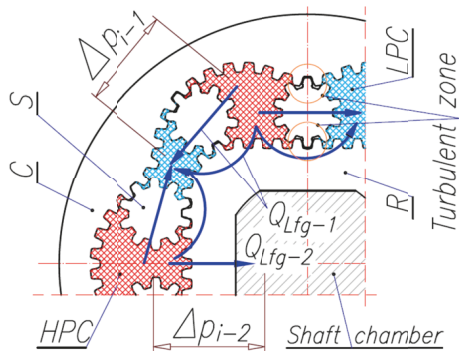

Fig. 6. Flows of liquid in flat clearances [25,26,28]

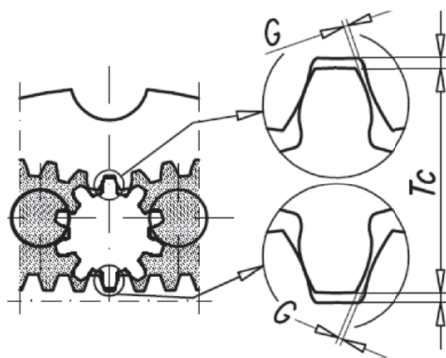

Fig. 7. Tip clearance  $T_c$  and backlash  $G$  [22,27,28]

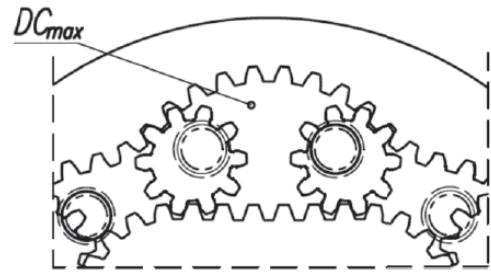
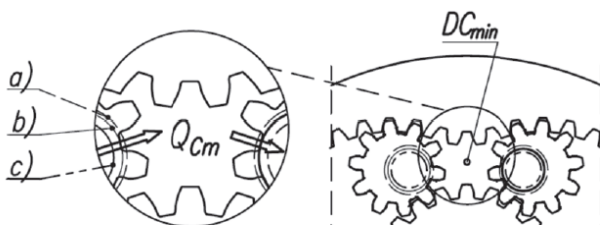

Fig. 8. Flow  $Q_{cm}$  in clearances of commutation unit [24]:  $DC_{min}$  – minimum volume of chamber,  $DC_{max}$  – maximum volume of chamber; a), b) and c) negative overlap, zero overlap and positive overlap, respectively

## KNOWN MODELS OF VOLUMETRIC LOSSES IN A PUMP

A number of mathematical formulas have been developed over the past 50 years to characterize the flow loss in hydraulic positive displacement machine, that is in pump and hydraulic motor. For example, in last years, models of volumetric losses in a hydraulic motor were described in [1,4,11,19,25,28]. Some of them can be adopted to describe the volumetric losses in a pump if the pump is the same type like the motor (for example axial piston pump and axial piston motor). It is possible because the physical phenomena in the same type hydraulic motor and pump is similar. For example, this mathematical model is [11,4]:

$$Q_{vl} = C_{\mu} \cdot \frac{\Delta p}{\mu} + C_v \cdot n + C_V \cdot \left(\frac{\Delta p}{\rho}\right)^{0,5} + C_P \cdot \left(\frac{\rho n^3}{\Delta p} + C_{\beta} \cdot n \cdot \Delta p + Q_{Lo}\right) \quad (4)$$

where:

$C_{\mu}$ ,  $C_v$ ,  $C_V$ ,  $C_P$ ,  $C_{\beta}$  – coefficients;

n – speed of pump;

$C_{Lo}$  – constant flow loss.

Another method of describing the volumetric losses in any type of pumps is [33]:

$$Q_{vl} = (C_1 + C_5 \cdot n + C_4 \cdot n \cdot q) \cdot \Delta p + (C_2 + C_3 \cdot n^{3/2}) \cdot \Delta p^2 \quad (5)$$

where  $C_1$ ,  $C_2$ ,  $C_3$ ,  $C_4$  and  $C_5$  are coefficients.

A similar mathematical model, taking into account the influence of liquid viscosity  $\mu$ , is proposed in [5]:

$$Q_{vl} = \sum_{i=0}^p \sum_{j=0}^q \sum_{k=0}^r \sum_{l=0}^s (C_{ijkl} \cdot q^i \cdot n^j \cdot \Delta p^k \cdot \mu^l) \quad (6)$$

where  $C_{ijkl}$  is the coefficient.

Another way of describing the volumetric losses in a pump with constant displacement is proposed in [19]:

$$Q_{vl} = k_1 \cdot q \cdot n \cdot \left(\frac{\Delta p_i}{p_n}\right)^{a_{pv}} \cdot \left(\frac{v}{v_n}\right)^{a_{vv}} \quad (7)$$

where:

$k_1, k_9, a_{pv}, a_{vv}, a_{nv}$  – coefficients;  
 $p_n$  – nominal pressure in the hydraulic circuit;  
 $v_n$  – related kinematic viscosity ( $v_n = 35cSt$ ).

The inconvenience of these models for pumps is that they describe the volumetric losses in general, without specifying the type of gaps and other sources of these losses. In addition, the authors of these mathematical formulas do not write about whether they are suitable for the description of the volumetric losses in a pump working with low viscosity liquid like water.

## NEW MODEL OF VOLUMETRIC LOSSES IN SATELLITE PUMP

The mathematical model describing the volumetric losses in hydraulic motor supplied with different liquids was presented in [25,28]. This model is dedicated to satellite motor and was designed taking into account the sources of volumetric losses into this motor. Due to the fact, that the construction of a satellite pump is based on the design of the satellite motor, the sources of volumetric losses in the pump are the same as in the motor. Therefore, it is sensible to adopt the model of volumetric losses in a satellite motor to describe the volumetric losses in a satellite pump. Thus, the volumetric losses in a satellite pump can be described with the equation [25,28] (Fig. 9):

$$Q_{vl} = Q_{Lfg} + Q_C + \Delta Q_{vl} + Q_{ex} \quad (8)$$

where:

$Q_{Lfg}$  – the flow rate in flat clearances of the working mechanism;

$Q_C$  – the flow rate in clearances of the commutation unit (short clearances);

$\Delta Q_{vl}$  – the increasing of flow rate;

$Q_{ex}$  – external leakage.

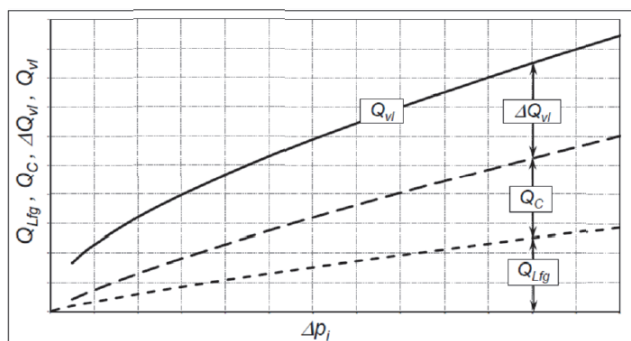

Fig.9. Characteristic of components of volumetric losses in pump

### FLOW RATE $Q_{Lfg}$ IN FLAT CLEARANCES

The methodology of measuring the flow rate  $Q_{Lfg}$  in flat clearances is described in [25,26]. The flow rate  $Q_{Lfg}$  can be described by the equation [25,26]:

$$Q_{Lfg} = \left(\frac{1}{v}\right)^{\left(\frac{\beta}{2-\beta}\right)} \cdot \left(\frac{1}{K \cdot \rho}\right)^{\left(\frac{1}{2-\beta}\right)} \cdot A_1 \cdot m \cdot \left(\frac{2 \cdot h^3}{A_2 \cdot m}\right)^{\left(\frac{1}{2-\beta}\right)} \cdot \Delta p_i^{\left(\frac{1}{2-\beta}\right)} \quad (9)$$

where:

$\beta$  – the degree of laminarity of the flow [25,26];

$v$  – kinematic viscosity of liquid;

$\rho$  – density of liquid;

$m$  – teeth module;

$A_1, A_2, K$  – coefficients;

$h$  – equivalent axial clearances of rotor and satellites

The equivalent axial clearances are described as [25,26]:

$$h = \frac{h_R + h_S}{2} - (D_C \cdot H + D_k) \cdot \Delta p_i \quad (10)$$

where:

$h_R$  and  $h_S$  – respectively: axial clearance of rotor and satellites;

$H$  – height of working mechanism (equal to height of curvature);

$D_k$  – the coefficient depends on stiffness of axial clearance compensation unit;

$D_C$  – the coefficient depends on stiffness of stator.

The degree of laminarity of the flow  $\beta$  for oil is [25,26]:

$$\beta_O = \frac{2 \cdot \ln(E \cdot X^F) + \ln\left(\frac{K_W \cdot \rho_W}{K_O \cdot \rho_O}\right)}{\ln(E \cdot X^F) + \ln\left(\frac{v_O}{v_W}\right)} \quad (11)$$

where:

$$X = \frac{1}{2} \cdot \frac{m}{h^3} \cdot K_W \cdot v_W^2 \cdot \rho_W \cdot A_2 \quad (12)$$

and the “o” and “w” indices refer to oil and water respectively.

The degree of laminarity of the flow  $\beta$  for water is [25,26]:

$$\beta_W = 2 - \frac{2 - \beta_O}{1 + F \cdot (2 - \beta_O)} \quad (13)$$

The coefficient  $F$  is calculated from the following equation:

$$E \cdot (\Delta p_i)^F = \frac{Q_{Lfg,W}}{Q_{Lfg,O}} \quad (14)$$

where:

$Q_{Lfg,W}$  and  $Q_{Lfg,O}$  – obtained from experimental data;

$E$  – the constant.

The characteristics of  $\beta=f(\Delta p_i)$  for oil and for water are shown in Fig. 10. For simplicity, it can be accepted that for both liquids in the whole range of  $\Delta p_i$  the  $\beta$  is constant.

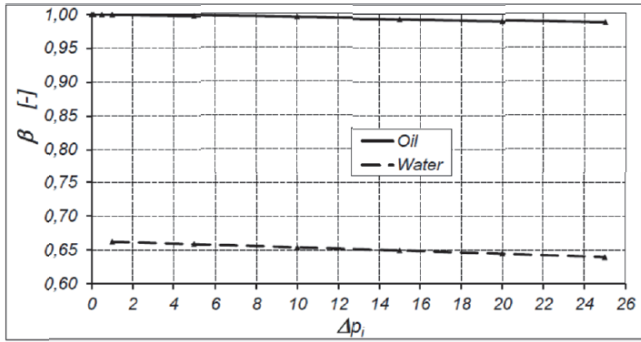

Fig.10. Degree of laminarity of the flow  $\beta$  in flat clearances of the pump for oil and water [25]

The values of coefficients  $\beta$ ,  $A_1$ ,  $A_2$ ,  $K$ ,  $D_k$  and  $D_C$  are calculated from experimental data and the methodology is shown in [25,26].

### FLOW RATE $Q_C$ IN COMMUTATION UNIT CLEARANCES

The methodology of measuring the flow rate  $Q_C$  in commutation unit clearances (Fig. 7) is described in [24,25]. The  $Q_C$  is described as [24,25]:

$$Q_C = C_1 \cdot (D_o \cdot h_s)^{C_2} \cdot \left(\frac{1}{\rho \cdot \nu^{C_3}}\right)^\gamma \cdot \Delta p_i^\gamma \quad (15)$$

where:

$D_o$  – the diameter of the outflow hole in commutation plate;  
 $C_1$ ,  $C_2$ ,  $C_3$  and  $\gamma$  – coefficients.

The values of coefficients  $C_1$ ,  $C_2$ ,  $C_3$  and  $\gamma$  are calculated from experimental data and the methodology is shown in [24,25].

### COMPONENT $\Delta Q_{vl}$

After determination of  $Q_{Lfg}$  and  $Q_C$  the component  $\Delta Q_{vl}$  can be calculated from equation (7) (from the experiment data) as:

$$\Delta Q_{vl} = Q_{vl} - (Q_{Lfg} + Q_C + Q_{ex}) \quad (16)$$

According to [25,28] the component  $\Delta Q_{vl}$  is defined as:

$$\Delta Q_{vl} = \Delta Q_{fc} + \Delta Q_{dch} + \Delta Q_b + \Delta Q_{id} \quad (17)$$

where:

$\Delta Q_{fc}$  – the flow rate depends on the compressibility of the liquid;

$\Delta Q_{dch}$  – the flow rate caused by the elastic deformation of working chambers;

$\Delta Q_b$  – the flow rate depends on the backlash size;

$\Delta Q_{id}$  – the flow rate depending on: the inertia of satellites, the inertia of the liquid in the working chambers.

The components  $\Delta Q_{fc}$ ,  $\Delta Q_{dch}$ ,  $\Delta Q_{vb}$  and  $\Delta Q_{id}$  are precisely described in [25].

The component  $\Delta Q_{vl}$  can be also written in a general form as:

$$\Delta Q_{vl} = \Delta q \cdot n \quad (18)$$

where  $\Delta q$  is the increase in displacement [ $\text{cm}^3/\text{rev}$ ].

### INCREASE IN DISPLACEMENT $\Delta q$

It follows from equations (3), (15) and (17) that:

$$\Delta q = q - \frac{Q + Q_{Lfg} + Q_C + Q_{ex}}{n} \quad (19)$$

In [25,28] it has been shown that  $\Delta q$  can be described by the formula:

$$\Delta q = \left(C \cdot \Delta p_i + \frac{C_{id}}{n^{0.5}}\right) \cdot m^2 \cdot H \quad (20)$$

where  $C$  and  $C_{id}$  are coefficients. The values of these coefficients are calculated from the experiment.

### EXTERNAL LEAKAGE

The source of external leakage  $Q_{ex}$  is the lack of tightness in pump ports. In normal pump operation conditions,  $Q_{ex}$  cannot occur and then  $Q_{ex}=0$ .

### MODEL OF VOLUMETRIC LOSSES

The volumetric losses  $Q_{vl}$  in the pump, expressed by the formula (8), in a developed form are as follows [25]:

$$Q_{vl} = \left(\frac{1}{\nu}\right)^{\left(\frac{\beta}{2-\beta}\right)} \cdot \left(\frac{1}{K \cdot \rho}\right)^{\left(\frac{1}{2-\beta}\right)} \cdot A_1 \cdot m \cdot \left(\frac{2 \cdot h^3}{A_2 \cdot m}\right)^{\left(\frac{1}{2-\beta}\right)} \cdot \Delta p_i^{\left(\frac{1}{2-\beta}\right)} + B_1 \cdot (D_o \cdot h_s)^{B_2} \cdot \left(\frac{1}{\rho_o \cdot \nu_o^{B_4}}\right)^{B_3} \cdot \Delta p_i^{B_3} + \left(C \cdot \Delta p_i + \frac{C_{id}}{n^{0.5}}\right) \cdot m^2 \cdot H \cdot n \quad (21)$$

### RESULTS OF EXPERIMENT

The test of the pumps prototype was conducted in a wide range of rotational speed  $n$  in order to show the pumps performance and possibility to work with an electric drive equipped with a frequency converter.

The experimentally determined characteristics  $Q_{vl}$  (divided into components  $Q_{Lfg} + Q_C$  and  $\Delta Q_{vl}$ ) as a function of pressure increase  $\Delta p_i$  in the working chambers are shown in Fig. 11 and in Fig. 12.



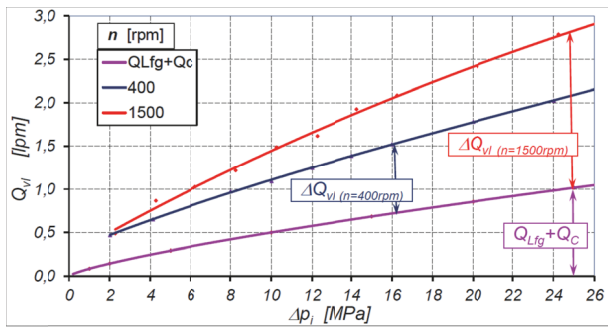

Fig.11. Characteristics of  $Q_{vl}=f(\Delta p_i)$ . Working medium: oil

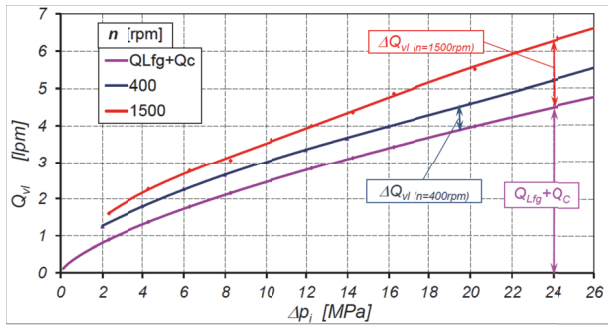

Fig.12. Characteristics of  $Q_{vl}=f(\Delta p_i)$ . Working medium water

The characteristics of  $\Delta q$  vs  $\Delta p_i$  designated according to (19) from experimental data are shown in Fig. 13 and in Fig. 14.

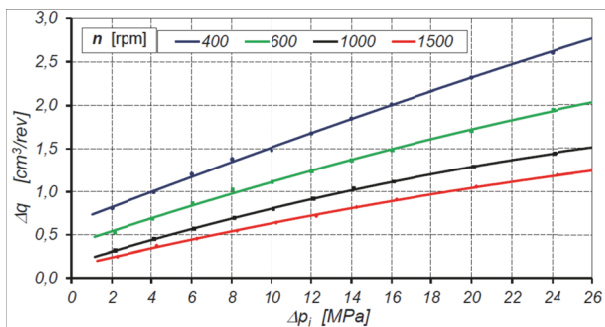

Fig.13. Experimental characteristics of  $\Delta q=f(\Delta p_i)$ . Working medium: oil

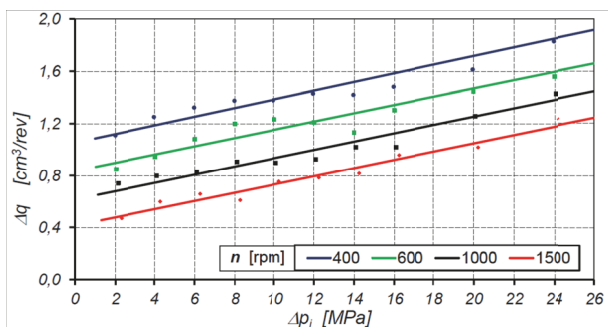

Fig.14. Experimental characteristics of  $\Delta q=f(\Delta p_i)$ . Working medium: water

The values of all mathematical model coefficients are calculated from experimental data and given in Tab. 1.

Tab.1. Values of coefficients in volumetric losses model for pump PSM-0,75 [24,25,26]

	$A_1$	$A_2$	$\beta$	$K_o$
	[-]	[-]	[-]	$\left[\frac{m}{MPa \cdot s}\right]$
Oil	0,145	0,17	0,99	1,141
Water	0,145	0,17	0,65	1,0
	$C_1$	$C_2$	$C_3$	$C_{id}$
	[-]	[-]	[-]	$\left[\frac{1}{(obr \cdot min)^{0,5}}\right]$
Oil	0,154	1,26	0,684	1,18
Water	2,5	1,05	0,183	2,37
	$C_1$	$C_t$	$\gamma$	$C$
	[-]	[-]	[-]	$\left[\frac{1}{MPa \cdot obr}\right]$
Oil	$0,583 \cdot 10^{-5}$	$0,282 \cdot 10^{-7}$	0,76	$5,12 \cdot 10^{-3}$
Water	$0,343 \cdot 10^{-3}$	$0,146 \cdot 10^{-7}$	0,55	$3,56 \cdot 10^{-3}$

## RESULTS OF CALCULATIONS

Based on the formula (20) the characteristics of  $\Delta q=f(\Delta p_i)$  are plotted in Fig. 15 and in Fig. 16.

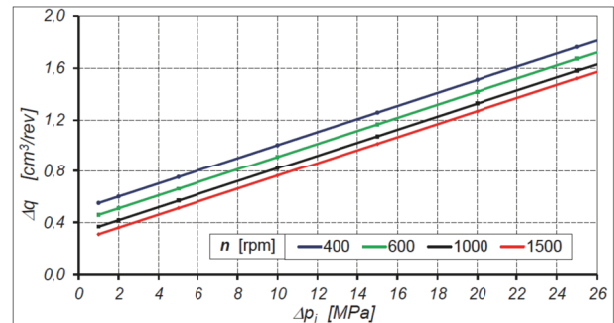

Fig.15. Characteristics of  $\Delta q=f(\Delta p_i)$  - the result of calculation according to formula (20). Working medium: oil

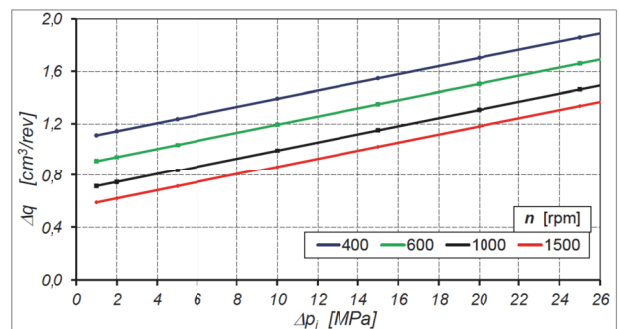

Fig.16. Characteristics of  $\Delta q=f(\Delta p_i)$  - the result of calculation according to formula (20). Working medium: water

The characteristics of  $Q_{vl}=f(\Delta p_i)$ , plotted according to the formula (20), are shown in Fig. 17 and in Fig. 18.

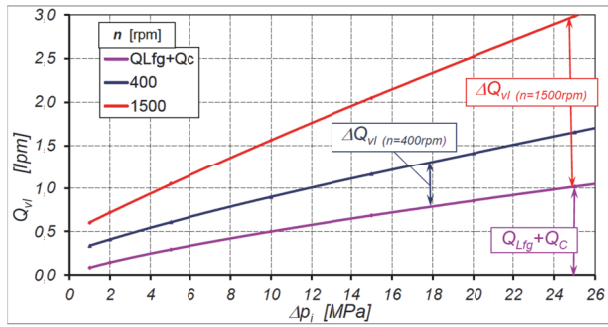

Fig.17. Characteristics of  $Q_{vl}=f(\Delta p_i)$  – the result of calculation according to formula (21). Working medium: oil

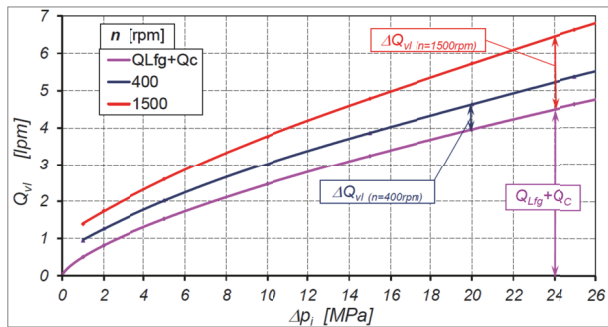

Fig.18. Characteristics of  $Q_{vl}=f(\Delta p_i)$  – result of calculation according to formula (21). Working medium: water

## DISCUSSION

The research results prove that the volumetric losses in the pump pumping water are at most three times greater than the volumetric losses in the pump pumping oil (Fig. 19). The greatest difference is observed in the pump working at low speed. Furthermore, for  $n=\text{const.}$ , the ratio of  $\frac{Q_{vl-w}}{Q_{vl-o}}$  is variable and decreases with increasing  $\Delta p$ . The smallest value of  $\frac{Q_{vl-w}}{Q_{vl-o}}$  is observed for the biggest values of  $n$ .

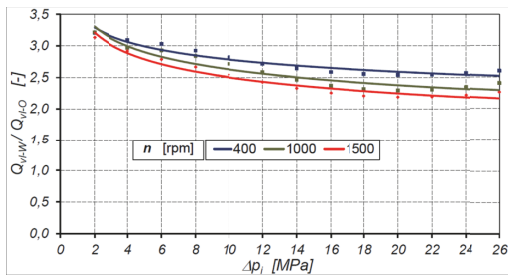

Fig.19. Characteristics of  $\frac{Q_{vl-w}}{Q_{vl-o}} = f(\Delta p_i)$

The values of volumetric losses (both for oil and water) in the pump, calculated according to the formula 21), differ from the values determined experimentally. These differences are defined as:

$$\delta Q_{vl} = \frac{Q_{vl} - Q_{vl(calc)}}{Q_{vl}} \cdot 100\% \quad (22)$$

The characteristics of  $\delta Q_{vl}=f(\Delta p_i)$  for oil and for water are shown in Fig. 20 and Fig. 21 respectively.

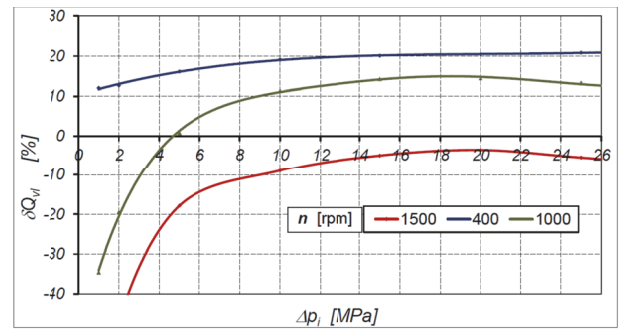

Fig.20. Characteristics of  $\delta Q_{vl}=f(\Delta p_i)$ . Working medium: oil

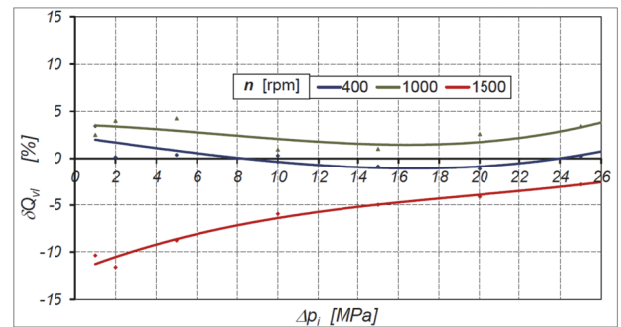

Fig.21. Characteristics of  $\delta Q_{vl}=f(\Delta p_i)$ . Working medium: water

It turns out that the greatest impact on the accuracy of calculation of the volumetric losses has the accuracy of calculation of the change of pump displacement  $\Delta q$ . The  $\Delta q$  calculated according to (20) gives the biggest mistake in the range of small values of rotational speed  $n$  (the biggest differences are observed for  $n < 600$  rpm – Fig. 13 ÷ Fig. 16).

## SUMMARY

The article presents the results of experimental research on volumetric losses in the newest satellite pump, for which the working medium was water and mineral oil. The experimental studies have shown that the type of liquid has an impact on the values of losses. The volumetric losses are bigger in a water pump than in an oil pump – especially at low loads  $\Delta p$  and low speeds  $n$ .

Experimental tests have also shown that the PSM pump can operate at a low rotational speed. It is recommended that the minimum speed is 400 rpm. At lower speed, there is too much leakage in relation to the pump capacity, which results

in a significant decrease in the pump's volume efficiency. Therefore, the experiment was done at a minimum rotational speed of 400 rpm.

Experimental studies have shown that the greatest source of volumetric losses in the pump is leakages in the working mechanism.

The mathematical model of volumetric losses in satellite motor has been adopted and developed for satellite pump. This model is based on an analysis of the sources of leakages in the pump. The coefficients in the mathematical model were calculated on the basis of the experimental data. This mathematical model quite accurately describes the volumetric losses in a satellite pump working with both mineral oil or water. For a pump speed of 1500 rpm (typical for pumps) and operating pressure above 8 MPa, the differences between simulation results and test results do not exceed 10%. Therefore, the volumetric losses in the pump supplied with various liquids can be assessed by comparison of the model coefficients.

The mathematical model presented in this article, is a component of a model of overall efficiency of the pump.

## REFERENCES

1. Balawender A.: Physical and mathematical model of losses in hydraulic motors. Developments in mechanical engineering, Gdansk University of Technology Publishers. Gdansk 2005, Poland
2. Dymarski C., Dymarski P.: Developing Methodology for Model Tests of Floating Platforms in Low-Depth Towing Tank. Archives of Civil and Mechanical Engineering, No 1/2016, DOI: dx.doi.org/10.1016/j.acme.2015.07.003.
3. Guzowski A., Sobczyk A.: Reconstruction of hydrostatic drive and control system dedicated for small mobile platform. American Society of Mechanical Engineers, 2014 doi: dx.doi.org/10.1115/FPNI2014-7862.
4. Hall S., Steward B.: Comparison of steady state flow loss models for axial piston pumps. 53rd, Fluid power; 2014 IFPE Technical Conference; Where all the Solutions Come Together and Connections are Made; 2014. Las Vegas, USA.
5. Ivantysyn J., Ivantysynova M., Hydrostatic pumps and motors, principals, designs, performance, modelling, analysis, control and testing. New Delhi, 2000. Akademia Books International.
6. Jasinski R.: Influence of design of hydraulic components on their operation in low ambient temperatures. Key Engineering Materials, Vol. 490, 2012. DOI:10.4028/www.scientific.net/KEM.490.106.
7. Jasinski R.: Problems of the starting and operating of hydraulic components and systems in low ambient temperature. Part IV. Modelling the heating process and determining the serviceability of hydraulic components during the starting-up in low ambient temperature. Polish Maritime Research, No 3 (95) 2017. DOI: 10.1515/pomr-2017-0089.
8. Jasinski R.: Problems of the starting and operating of hydraulic components and systems in low ambient temperature. Part I. Polish Maritime Research, No 4/2008. DOI: doi.org/10.2478/v10012-007-0095-9.
9. Jasinski R.: Problems of the starting and operating of hydraulic components and systems in low ambient temperature. Part II. Polish Maritime Research, No 1/2009. DOI: doi.org/10.2478/v10012-008-0012-x.
10. Jasinski R.: Problems of the starting and operating of hydraulic components and systems in low ambient temperature. Part III. Methods of determining parameters for correct start-ups of hydraulic components and systems in low ambient temperatures. Polish Maritime Research, No 4/2009. DOI: doi.org/10.2478/v10012-008-0052-2.
11. Jeong H-S.: A novel performance model given by the physical dimensions of hydraulic axial piston motors: model derivation. Journal of mechanical science and technology, Vol. 21, No 1/2007. DOI: doi.org/10.1007/BF03161714.
12. Kollek W., Osinski P., Warzynska U.: The influence of gear micro pump body asymmetry on stress distribution. Polish Maritime Research, No 1/2017. DOI: doi.org/10.1515/pomr-2017-0007.
13. Litwin W., Dymarski C.: Experimental research on water lubricated marine stern tube bearings in conditions of improper lubrication and cooling causing rapid bush wear. Tribology International Vol. 95 (2016). DOI: 10.1016/j.triboint.2015.12.005.
14. Litwin W., Olszewski A.: Water-Lubricated Sintered Bronze. Journal Bearings - Theoretical and Experimental Research. Tribology Transactions, vol. 57, No. 1/2014. DOI: 10.1080/10402004.2013.856980.
15. Lubinski J., Sliwinski P.: Multi parameter sliding test result evaluation for the selection of material pair for wear resistant components of a hydraulic motor dedicated for use with environmentally friendly working fluids. Solid State Phenomena, No 225/2015. DOI: doi.org/10.4028/www.scientific.net/SSP.225.115.
16. Maczyszyn A.: Investigation method and mathematical model of pressure losses in hydraulic rotary motor. Polish Maritime Research, No. 97/2018 Vol. 25. DOI: 10.2478/pomr-2018-0011.

17. Osinski P., Chruscielski G.: Strength calculations of an element compensating circumferential backlash in the external gear pump. *Journal of Theoretical and Applied Mechanics*. Vol. 54, No. 1/2016. DOI: 10.15632/jtam-pl.54.1.251.
18. Osinski P., Deptula A., Partyka M.: Discrete optimization of a gear pump after tooth root undercutting by means of multi-valued logic trees. *Archives of Civil and Mechanical Engineering*, No 4/2013, DOI: 10.1016/j.acme.2013.05.001.
19. Paszota Z.: Energy losses in hydrostatic drive. LABERT Academic Publishing, 2016.
20. Patrosz P.: Deformation in the axial clearance compensation node in the satellite pump unit. *Hydraulika i Pneumatyka* 1/2014, Poland.
21. Pobedza J., Sobczyk A.: Properties of high pressure water hydraulic components with modern coatings. *Advanced Materials Research*. Trans Tech Publications Ltd, 849/2014. DOI: 10.4028/www.scientific.net/AMR.849.100.
22. Sliwinski P.: New satellite pumps. *Key Engineering Materials*, No 490/2012. DOI: doi.org/10.4028/www.scientific.net/KEM.490.195.
23. Sliwinski P.: Pressure losses and power balance in the unloaded satellite pump. *Hydraulika a Pneumatika*, No 1-2/2013.
24. Sliwinski P.: Influence of water and mineral oil on the leaks in satellite motor commutation unit clearances. *Polish Maritime Research*. Vol. 24, 3 (95) 2017. DOI: 10.1515/pomr-2017-0090.
25. Sliwinski P.: Satellite displacement machines. Basis of design and analysis of power loss. Gdansk University of Technology Publishers, 2016.
26. Sliwinski P.: The flow of liquid in flat gaps of satellite motors working mechanism. *Polish Maritime Research*, No 2/2014. DOI: 10.2478/pomr-2014-0019.
27. Sliwinski P.: The influence of water and mineral oil on mechanical losses in the displacement pump for offshore and marine applications. *Polish Maritime Research*. Vol. 25, Special Issue S1 (97) (2018). DOI: 10.2478/pmr-2018-0040.
28. Sliwinski P.: The influence of water and mineral oil on volumetric losses in a hydraulic motor. *Polish Maritime Research*. Vol. 24. Special Issue S1 (93) (2017). DOI: 10.1515/pomr-2017-0041.
29. Stosiak M., Kollek W., Osiński P., Cichon P., Wilczynski A.: Problems relating to high-pressure gear micro pumps. *Archives of Civil and Mechanical Engineering*, No 1/2014. DOI: 10.1016/j.acme.2013.03.005.
30. Stosiak M.: The impact of hydraulic systems on the human being and the environment. *Journal of Theoretical and Applied Mechanics*, Vol. 53 No 2/2015. DOI: 10.15632/jtam-pl.53.2.409 .
31. Stosiak M.: The modeling of hydraulic distributor slide-sleeve interaction. *Archives of Civil and Mechanical Engineering*, No 2/2012. DOI: 10.1016/j.acme.2012.04.002.
32. Walczak P., Sobczyk A.: Simulation of water hydraulic control system of francis turbine. *American Society of Mechanical Engineers*, 2014. DOI: dx.doi.org/10.1115/FPNI2014-7814.
33. Zarotti G., Nevegna N.: Pump efficiencies - approximation and modeling. *Fluids quarterly*, No 14/1983.
34. Zloto T., Nagorka A.: An efficient FEM for pressure analysis of oil film in a piston pump. *Applied Mathematics and Mechanics*, vol.30, No 1/2009. DOI: 10.1007/s10483-009-0106-z.

#### CONTACT WITH THE AUTHOR

**Paweł Śliwiński**

*e-mail: pawel.sliwinski@pg.edu.pl*

Gdańsk University of Technology  
Narutowicza 11/12  
80-233 Gdansk  
**POLAND**