

THE IMPACT OF CRUSHED ROCK SPOIL ON PITTING CORROSION OF SELECTED STAINLESS STEELS

The paper presents the results of the pitting resistance investigations of selected stainless steels in the chloride environment and the simultaneous impact of erosive factors using the cyclic polarization technique. Additionally, using electrochemical techniques, ie: electrochemical impedance spectroscopy (EIS) and measurement of corrosion potential, the behavior of the passive layer of selected stainless steels in the environment of chlorides and erosion was examined. On the basis of the obtained results, the resistance of stainless steels 1.4301 and 1.4404 was found, both on the effect of chloride ions and erosive factors in the studied systems. Both tested steels are susceptible to pitting corrosion. It was found that a good measure of erosive impact on stainless steel is both impedance spectrum analysis and continuous monitoring of the corrosion potential of steel.

Keywords: corrosion, erosion, pitting corrosion, EIS

1. Introduction

Corrosion is a process defined as the destruction of construction materials, particularly metals and alloys, under the influence of the surrounding environment [1]. It touches all possible branches of industry. Especially, problems related to this phenomenon are revealed in the ore mining and processing industry [2]. Corrosion that exceeds the acceptable level is often associated with the need to use waters from mine drainage as a process media. The content of sodium chloride and other salts is associated with high water corrosivity. The presence of rock material with different fragmentation interacts with the aggressive environment [3]. A strong synergy between the erosion and corrosion process is observed [4]. The problem of searching for new construction materials and methods of corrosion protection is a key issue in this case. The surface erosion-corrosion depends on the velocity of the solid particles, impact angle, mechanical strength and sharpness [5] of the particles involved in the process [6]. The erosion-corrosion of stainless steels is mainly associated with the destruction of the passive film and problems with its restoration in an aggressive environment [7].

The processes leading to the optimal construction resistance to aggressive environments begin at the design stage of the structure. Giving the right shape and selection of construction materials allows to significantly reduce the occurrence of corrosion on the object's surface [8].

In most cases, however, work is carried out related to the selection of appropriate corrosion protection technology. In ad-

dition to the most commonly used protection using various types of coatings, cathodic protection and much less anodic protection are also used. In the conditions of interaction of some aggressive environments, various protection technologies are combined. An example is the seawater environment where protective coatings interact with cathodic protection [9,10]. Often the optimal solution that effectively reduces the corrosion rate is the use of corrosion inhibitors [11].

However, it should be definitely stated that the choice of construction material is decisive when we want to obtain the most optimal operating conditions. In order for this type of operation to be carried out, we must have knowledge about the behavior of construction materials in conditions with different corrosive hazards.

In the conditions of copper ore processing, in addition to the corrosive process water environment and the rock strengthening its effect on the corrosion of construction materials, the presence of copper ions also affects the process media [12].

Fig. 1 shows a view of a sample made of 1.0117 structural steel and 1.4541 stainless steel exposed for approx. 2 years. The exhibition took place at the ore enrichment plant in KGHM Polska Miedź. Both samples were in permanent immersion.

The paper presents the results of measurements on popular 1.4301 and 1.4404 stainless steels in conditions where, apart from the risk of chloride ions, there is also the problem of wiping the steel surface with grounded rock containing copper ore for the flotation process.

* GDANSK UNIVERSITY OF TECHNOLOGY, FACULTY OF CHEMISTRY, DEPARTMENT OF ELECTROCHEMISTRY, CORROSION AND MATERIALS ENGINEERING 11/12 GABRIELA NARUTOWICZA STR., 80-233 GDANSK, POLAND

** KGHM POLSKA MIEDŹ S.A.

[#] Corresponding author: stefan.krakowiak@pg.edu.pl

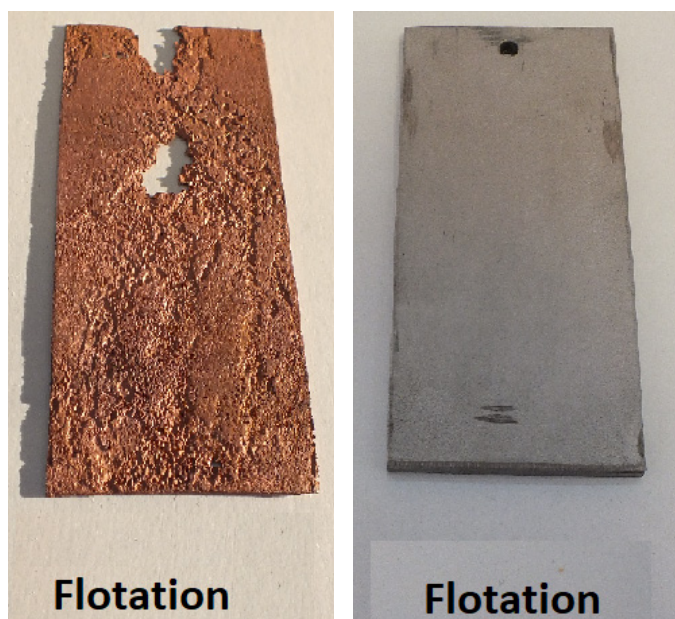

Fig. 1. Steel samples after a two-year exposure at the ore enrichment plant: left – 1.0117, right – 1.4541

The aim of the authors of the work was to select on the basis of measurements the most reliable electrochemical method that allows monitoring the phenomenon of erosion on constructions made of stainless steels.

2. Experimental

The tests were carried out on stainless steels type 1.4301 and 1.4404. The chemical composition of steel is shown in the Table 1. The specimens were abraded to 800 finishes with SiC grit papers, degreased in acetone, washed with distilled water, and dried.

TABLE 1

Chemical composition of investigated stainless steel

EN	AISI	Weight %					
		Cr	Ni	Mo	N	C	PREN
1.4301	304	18,1	8,3	—	—	0,04	20,08
1.4404	316L	17,2	10,1	2,1	—	0,02	28,5

The test solution was prepared from sodium chloride and demineralized water. The concentration of sodium chloride was consistent with the composition of the mine water used in the copper ore enrichment process. In order to investigate the effect of erosion on the corrosion process of stainless steels, a rock containing copper ore was added to the solution.

Electrochemical tests were performed using the GAMRY INSTRUMENTS Reference 600 measuring system controlled by a computer. In order to determine the susceptibility of the investigated stainless steels to pitting corrosion, cyclic polarization tests were carried out [13,14]. The measurements were carried out in a system with and without erosive factor, respectively.

Cyclic polarization tests were performed at the potential changes rate equal to 1 mV/s. All potentials presented in the paper are given relative to the saturated calomel electrode characterized by the potential of $E = 0.241\text{ V}$ vs normal hydrogen electrode.

Electrochemical Impedance Spectroscopy (EIS) measurements were performed using the GAMRY INSTRUMENTS Reference 600 device. The measurement was performed within the range from 50 kHz to 0.01 Hz. The amplitude of the perturbation signal was 50 mV. The analysis of research results was performed using the ZSimpWin optimization program. Since no pitting corrosion is initiated during EIS measurement, the Nyquist replacement scheme can be used to optimize results [15,16]. An equivalent circuit generated through frequency fitting from all studied spectra is shown in Fig. 2. The validity of this equivalent circuit to simulate the electrochemical behavior of passive stainless steels was previously used [17,18].

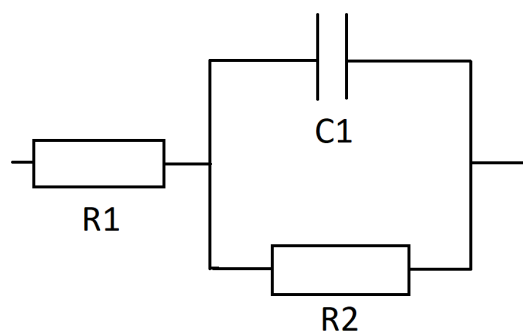

Fig. 2. An electrical equivalent circuit used to assess the results of the stainless steel test using the EIS method

The resistance, R_2 , and the capacity, C_1 are commonly associated with the electrochemical behavior of the passive layer [3,19].

3. Results

Before starting electrochemical tests, it was checked how the brine doped with crushed rock affects the surface of stainless steel. For this purpose, for a period of about 10 hours, a sample of 1.4301 steel was exposed in a strongly mixed solution intended for testing. The steel used in the study was not prepared in any way, only degreased in acetone.

A structure similar to that found on heat-treated austenitic steels that have undergone intercrystalline corrosion has been found on the surface of the sample prior to stainless

After exposure, the observed structure disappears. On the surface the effects of erosion caused by the action of crushed rock are visible and corrosion pits appear (Fig. 3).

The results of the pitting corrosion susceptibility measurements are presented in Fig. 4 in the form of the $\log(i) = f(E)$ relationship. After passing into a stable passive state 1.4301 stainless steel at a potential approx. -0.06 V begins to corrode in a metastable state. The pits formed are subject to repassing. On the polarization curve, strong current fluctuations are visible.

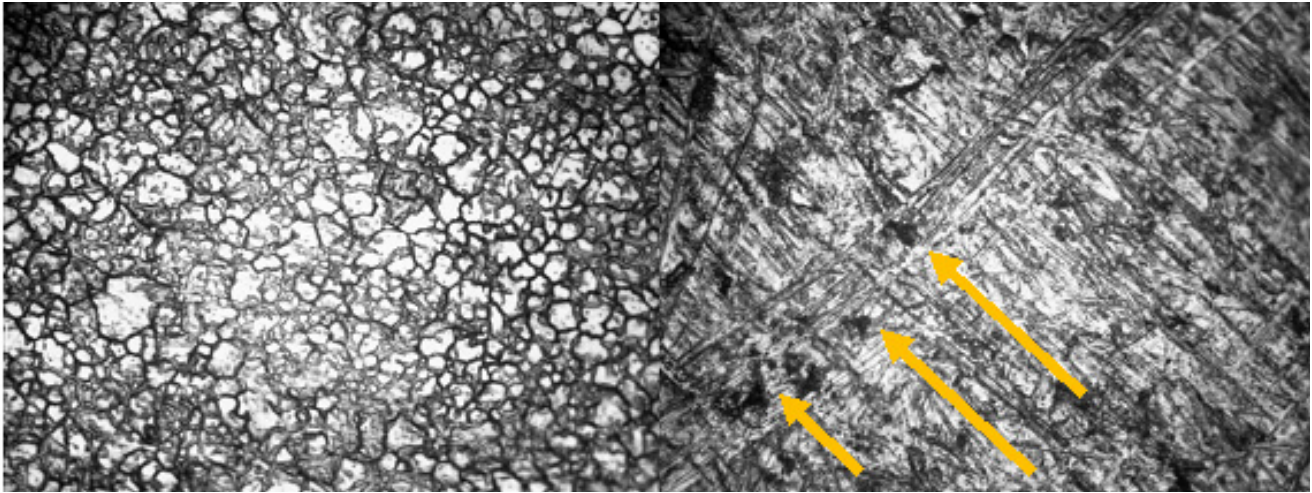

Fig. 3. Microscopic view of 1.4301 steel surface before and after erosion

After exceeding the potential of 0.200V, there is a rapid development of new pits. The results obtained indicate that 1.4301 steel exhibits susceptibility to pitting corrosion. The concentration of chloride ions in industrial water significantly exceeds the Critical Chloride Concentration value for 1.4301 stainless steels.

1.4404 steel also undergoes pitting corrosion in industrial water. However, the higher pitting corrosion potential (0.463 V) indicates better resistance of this steel in the test conditions.

Fig. 5 shows the course of the cyclic polarization curve obtained for stainless steel 1.4301. Resistance to pitting corrosion is similar to the conditions without the erosive factor. There is a less stable passive state on the polarization curve and the earlier occurrence of current fluctuations associated with the formation of metastable pits. In addition, in the case of stainless steels tested in an environment without an erosive factor, the protection

potential (E_{OC}) was higher than the corrosion potential (E_{CORR}). This phenomenon is not observed in the case of exposure in an erosive environment (Fig. 6).

Table 2 shows the characteristic pitting corrosion potentials determined on the basis of polarization curves for the tested stainless steels.

TABLE 2

Characteristic potentials for pitting corrosion

Steel	Erosion factor	E_{np} / V	E_{cp} / V
1.4301	-	0,201	-0.116
	+	0,196	-0.246
1.4404	-	0,463	-0.039
	+	0,430	-0.080

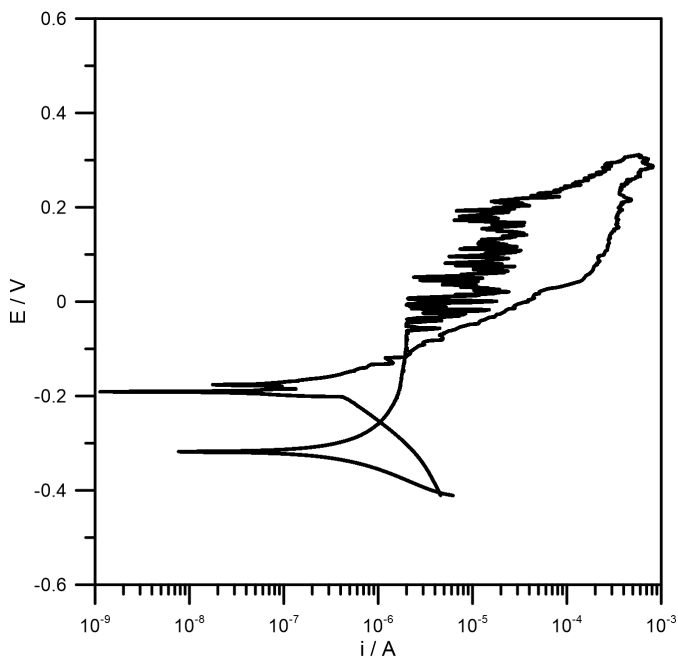

Fig. 4. Cyclic polarization scan for 1.4301 stainless steel. Measurement without erosive factor

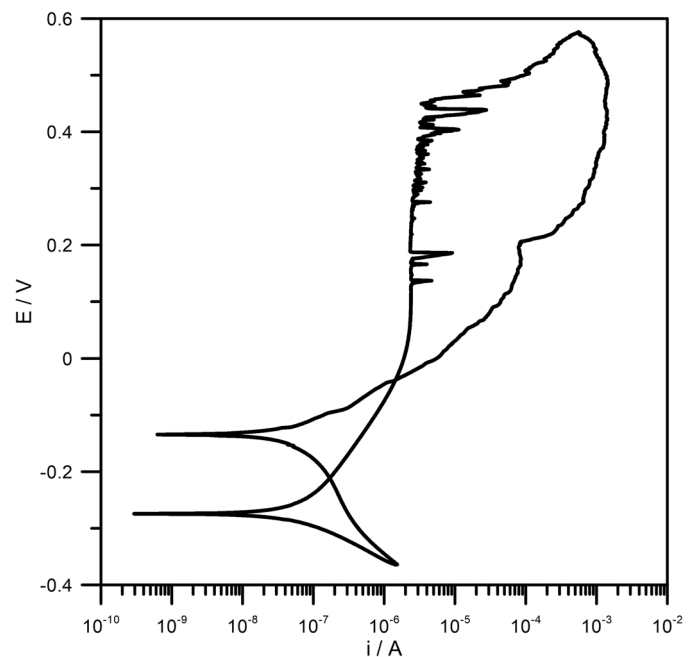

Fig. 5. Cyclic polarization scan for 1.4404 stainless steel. Measurement without erosive factor

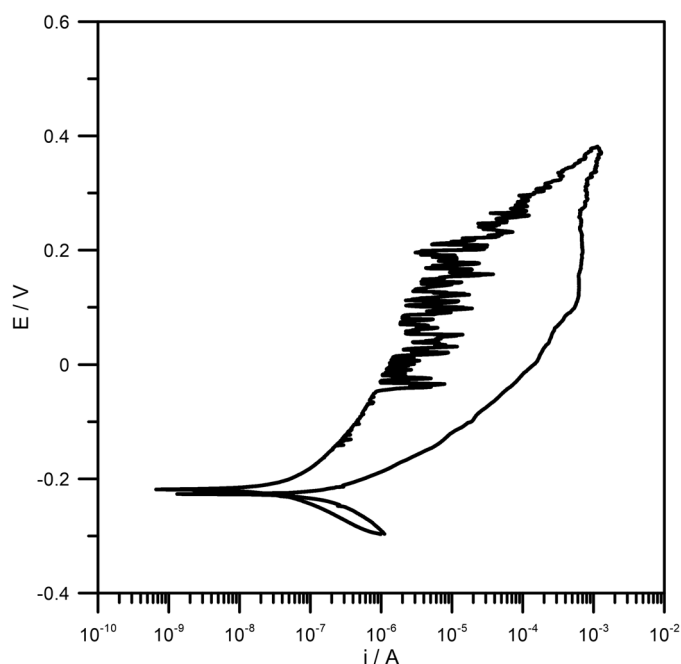

Fig. 6. Cyclic polarization scan for 1.4301 stainless steel. Measurement with erosive factor

According to predictions, the pitting corrosion potential for 1.4301 stainless steel is lower than for 1.4404 stainless steel. After activating the erosive factor, the E_{np} value decreases in both cases, which indicates an increase in susceptibility to pitting corrosion. The problem of localized corrosion is one of the main disadvantages of stainless steels when they are exposed to chloride solutions [20-22].

Fig. 7-8 show the corrosion potential changes of 1.4301 and 1.4404 stainless steel. The brine solution was mixed. No erosive factor in the form of a copper-bearing rock was added. For both steels in the initial period of exposure an increase in the corrosion potential is observed. This is the result of the restoration of the passive layer, which has been removed in the process of preparing samples for testing.

Fig. 9-10 show changes in corrosion potential of 1.4301 and 1.4404 stainless steel. The brine solution was mixed. In addition, an erosive factor in the form of a copper-bearing rock was added. The addition of an erosive factor causes a large drop in the corrosion potential. The reason for this phenomenon is the partial removal of the passive layer by the erosive factor. On the surface of the tested steel, active-passive cells are formed and self-healing processes of the oxide layer take place. The observed fluctuations of potential over time are the result of these processes taking place on the surface of stainless steel.

The increase in value visible in the final part of the potential change record visible in Fig. 9 is related to the stopping of the rock movement in the electrochemical cell. At this point the reconstruction of the damaged passive layer begins.

The Fig. 11-12 shows the impedance spectra (Nyquist plot) obtained for both tested stainless steels under conditions without erosive effect of the rock. In the passive state the elementary

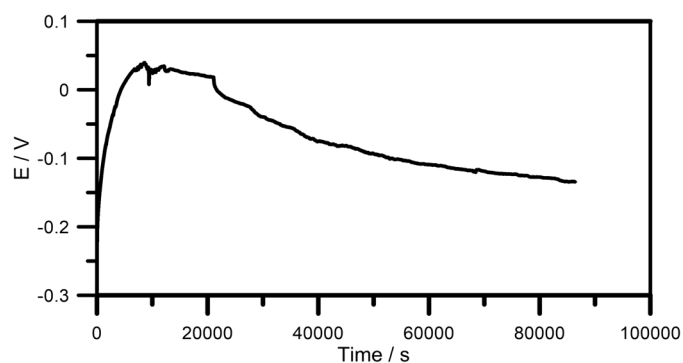

Fig. 7. Changes in corrosion potential of 1.4301 stainless steel in 22 g/dm³ solution of sodium chloride. Mixed solution

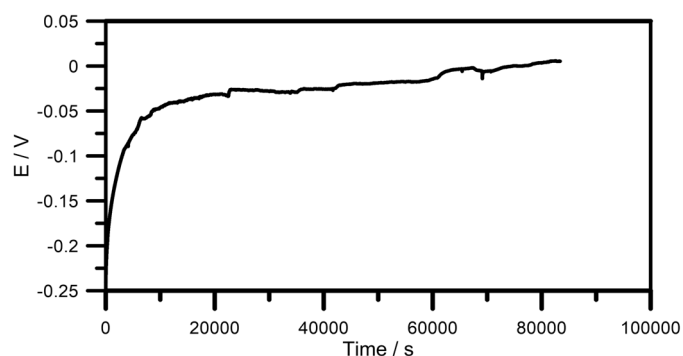

Fig. 8. Changes in corrosion potential of 1.4404 stainless steel in 22 g/dm³ solution of sodium chloride. Mixed solution

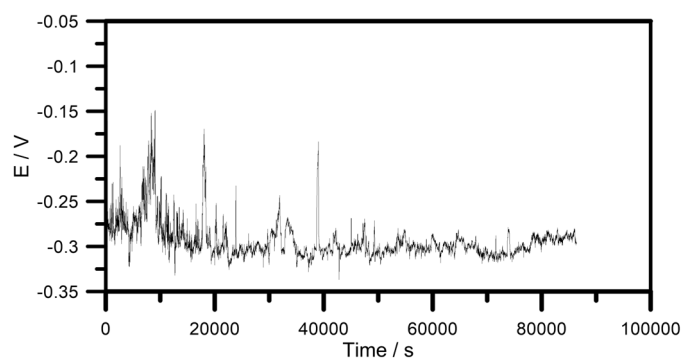

Fig. 9. Changes in corrosion potential of 1.4301 stainless steel in 22 g/dm³ solution of sodium chloride admixed rock containing copper ore. Mixed solution

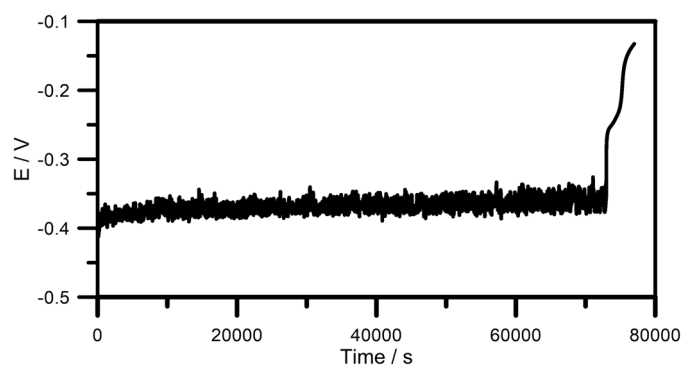

Fig. 10. Changes in corrosion potential of 1.4404 stainless steel in 22 g/dm³ solution of sodium chloride admixed rock containing copper ore. Mixed solution

impedance spectra have the form of straight lines. In the condition without erosive effect impedance spectra have a distinct capacitive character. The shape of an elementary spectra in case of 1.4301 and 1.4404 stainless steels are identical. However for erosive condition their character changes.

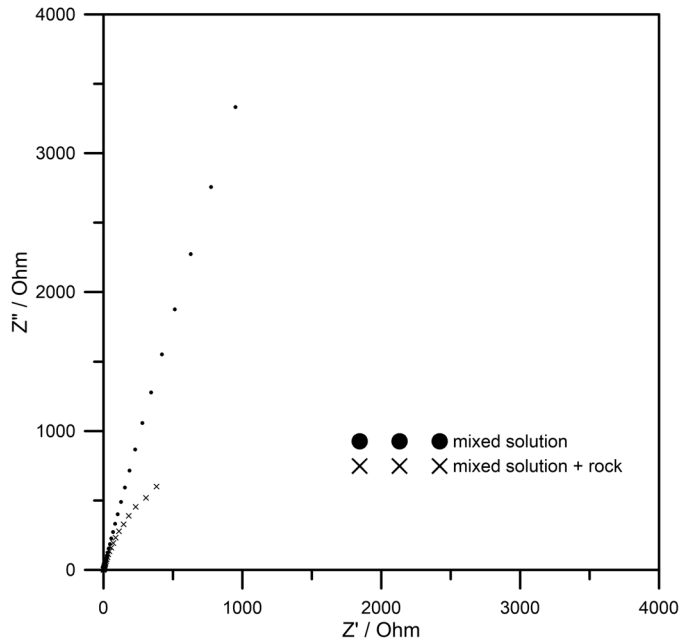

Fig. 11. Nyquist plots of austenitic 1.4301 stainless steel specimen in 22 g/dm^3 solution of sodium chloride

The addition of an erosive factor leads to a decrease in the resistance of the tested system. The shape of the impedance spectra indicates charge transfer control of corrosion process.

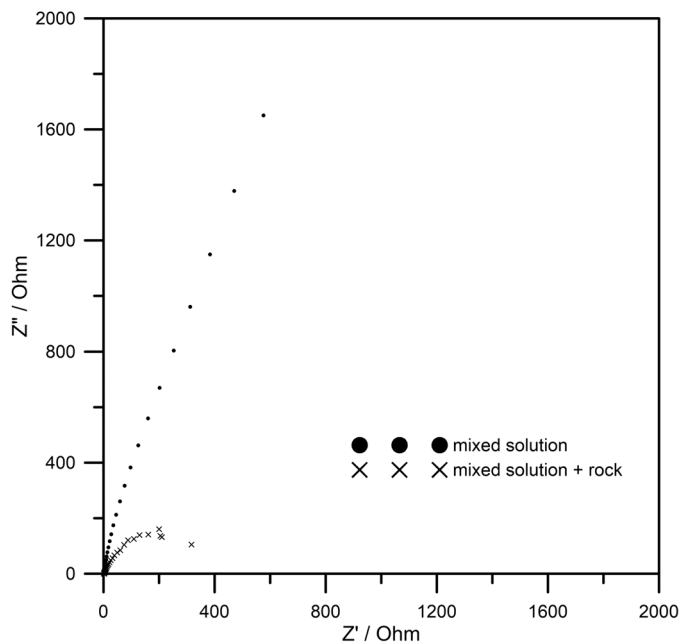

Fig. 12. Nyquist plots of austenitic 1.4404 stainless steel specimens in 22 g/dm^3 solution of sodium chloride

Obtained values of charge transfer resistance indicate a significant reduction in value in the presence of an erosive factor. At the same time, the measured capacity increases due to the increase in the capacity of the double electrical layer appearing in areas without a passive layer (Table 3).

TABLE 3

EIS measurements results

Steel	Erosion factor	R2 / Ω	C1 / F	χ^2
1.4301	-	8132	0,00075	2.44×10^{-4}
	+	412	0,00235	7.65×10^{-4}
1.4404	-	41000	0,00041	5.24×10^{-4}
	+	2225	0,00185	7.86×10^{-4}

Fitting of the theoretical electrical equivalent circuit to the experimental results is described by the parameter χ^2 . Its extremely low value confirms good compatibility between the experimental and theoretical results (Table 3).

4. Conclusions

Based on the conducted electrochemical and microscopic observations, the following general conclusions can be made:

- The corrosive environment existing in copper-bearing rock processing plants is extremely aggressive due to the use of mine water rich in sodium chloride as a carrier in technological processes.
- The presence of crushed rock containing copper ore is an additional element strengthening aggressiveness and increasing the rate of corrosion. The values obtained during continuous measurement of the corrosive potential of the sample is a good indicator of the condition of the sample.
- The high level of chloride ions in industrial water determines the resistance of steel to pitting corrosion. 1.4301 and 1.4404 steels are susceptible to pitting corrosion under these conditions. Further research will target the search for steel with a higher PREN.
- The EIS measurements revealed that the impedance of passive film of non-eroded samples specimens was always higher than eroded ones.
- Both electrochemical impedance spectroscopy and corrosion potential measurement can be used to monitoring the effect of erosion on the condition of stainless steel.

REFERENCES

- [1] P.A. Schweitzer, Fundamentals of Corrosion Mechanisms, Causes and Preventative Methods, Taylor and Francis Group, 2010.
- [2] S. Dudka, D.C. Adriano, J. Environ. Qual. **26** (3) 590-602 (1997).
- [3] M.Y. Naz, S.A. Sulaiman, et al., Measurement. **106** (2) 203-210 (2017).

- [4] C.G. Duan, V.Y. Karelin (ed.), *Abrasive erosion & corrosion of hydraulic machinery*, Imperial College Press, 2002.
- [5] G.B. Stachowiak, M. Salasi, W.D.A. Rickard, G.W. Stachowiak, *Corrosion Science* **111**, 690-702 (2016).
- [6] H.J.D. Bruyn, *Int. J. Press. Vessel. Pip.* **66** (1-3) 293-303 (1996).
- [7] A. K. Mahmood, A. A.Khadom, *J. Fail. Anal. and Preven.* **16** (6) 1071-1081 (2016).
- [8] R.V. Pludek, *Design and Corrosion Control*, Palgrave, 2014.
- [9] K. Żakowski, *Anti-corrosion Methods and Materials* **58** (4), 167-172 (2011).
- [10] K. Żakowski, M. Szociński et al., *Anti-corrosion Methods and Materials* **60** (2), 95-99 (2013).
- [11] C.C. Nathan (ed.), *Corrosion Inhibitors*, NACE, Houston, Texas.
- [12] M.M. Lachowicz, M.B. Lachowicz, *Archives of Metalurgy and Materials* **60** (4), 2657-2661 (2015).
- [13] S. Esmailzadeh, M. Aliofkhaezai, H. Sarlak, *Protection of Metals and Physical Chemistry of Surfaces* **54** (5), 976-989 (2018).
- [14] A.R. Nuradityatama, M.F. Rendi, S. Setiawan, *International Journal of Mechanical Engineering and Robotics Research* **6** (6), 512-518 (2017).
- [15] G. Monrrabal, B. Ramirez-Barat, A. Bautista, F. Velasco, E. Cano, *Metals* **500** (8), 1-16 (2018).
- [16] Xiu-qing Xu et. al, *Int. J. Electrochem. Sci.*, **13** (10), 4298-4308 (2018).
- [17] L. Freire, M.J. Carmezim, M.G.S. Ferreira, M.F. Montemor, *Electrochim. Acta*, **55** (21), 6174-6181 (2010).
- [18] C.M. Abreu, M.J. Cristobal, R. Losada, X.R. Nóvoa, G. Pena, M.C. Perez, *Electrochim. Acta* **51** (8-9), 1881-1890 (2006).
- [19] B.A. Boukamp, *Solid State Ionics* **20** (1) 31 (1986).
- [20] G.S. Frankel, N. Sridhar, *Materials Today* **11** (10), 39-44 (2008).
- [21] M.P. Ryan, D.E. Williams, R.J. Chater, B.M. Hutton, D.S. McPhail, *Nature* **415** (2), 770-77 (2002).
- [22] K. Darowicki, S. Krakowiak, *Electrochimica Acta* **42** (16), 2559-2562 (1994).

