

Received February 19, 2020, accepted March 10, 2020, date of publication March 20, 2020, date of current version March 31, 2020.

Digital Object Identifier 10.1109/ACCESS.2020.2982264

# Hybrid Expert System for Computer-Aided Design of Ship Thruster Subsystems

ANDRZEJ KOPCZYŃSKI 

Department of Control Engineering, Faculty of Electrical and Control Engineering, Gdańsk University of Technology, 80-233 Gdansk, Poland

e-mail: andrzej.kopczynski@pg.edu.pl

This work was supported in part by the Polish Scientific Research Committee under Grant 4T11A00925, and in part by the Gdansk University of Technology.

**ABSTRACT** The article presents an expert system supporting the design of ship's power subsystems, in particular the thruster subsystem. The proposed hybrid expert system uses the results of simulation tests as the additional source of knowledge. The results of system operation are collated in a report which can be used as part of ship design description. The work oriented on developing the expert system is the continuation of the research carried out in cooperation with the shipyard's design office, the main aim of which was to automate selected stages of the ship's design process. The hybrid expert system for computer-aided design of ship thruster subsystems can support designers by creating part of the technical description of the thruster subsystem, evaluation of static and dynamic properties, and by checking if design solutions have met the requirements of classification societies. Additionally, the expert system supports collecting and providing information about the elements and structures of the thruster subsystem. Finally, the system provides a document with the description of the thruster structure and elements used in it. The proposed expert system is dedicated to the initial design stages.

**INDEX TERMS** Expert system, ship design, simulation, mathematical model, shipbuilding, thruster.

## I. INTRODUCTION

The ship design process is complicated and causes a lot of problems for designers. Several types of designs can be named which should be prepared before the ship is built, including: the offer design (OD), the contract design (CD), and the executive design (ED). After finishing the ship construction, the as-built documentation (ABD) is also prepared, which takes into account changes which arose during the shipbuilding. The cost to be incurred by the design office during implementation of each of the abovenamed design tasks is expressed by the number of human-hours spent on all stages of design. All project tasks must be carried out by designers with necessary knowledge and experience. Then the results are checked and, after obtaining the approval, presented to the future ship owner/investor.

Though there are thousands of ships in the world, new ones are built on the basis of new designs. Usually, from one to over a dozen of similar units are built. New designs usually take advantage of solutions positively verified on already

existing ships. In the ship design, individual innovative solutions are applied, but only if they significantly affect savings and/or safety of future ship exploitation.

Depending on the flag under which the ship is expected to sail, the ship's design and the installed devices must meet restrictive regulations of the appropriate classification society (e.g. PRS - Polish Register of Shipping) [1], [2].

During design preparation, the documentation is created regarding the construction of the hull, electrical equipment, fire protection systems, etc. One of the design tasks is correct preparation of the design of a separate electricity grid. For example, when designing the power system for a ship, the chosen elements should meet the requirements of the selected classification society, along with static and dynamic requirements. The regulations of classification societies determine, among other things, the overload resistance requirements for the ship power system, including overload time duration and acceptable voltage changes in this system.

The ship automation systems design is labour-intensive and complex. Mistakes in the design process can be costly to remove. Difficulties in the ship's subsystems design result from the following reasons [3]:

The associate editor coordinating the review of this manuscript and approving it for publication was Xiaogang Jin .

--the power system installed on the ship is very complex - it consists of many strongly interconnected subsystems,

--the improper operation of ship power subsystems directly threatens the ship safety (e.g. it can result in a blackout),

--the automation systems perform various functions and consist of many types of elements and devices,

-- the component elements and the automation systems offered by different manufacturers for modern ships are still changing due to growing requirements and fast technology development,

--the design process should take into account the relevant requirements of classification societies, international conventions and shipowners' preferences, as well as the capabilities of shipyards and component elements suppliers,

--the design process of ship power subsystems is correlated with the design process of the entire ship and should be implemented within a specified and possibly short time.

The design process of ship automation system carried out in the shipyard, as part of the entire ship design process, consists of many stages. The arrangements, on various design stages, are made with the shipowner, classification societies and equipment manufacturers [3], [4].

Currently, in the publications, besides the classic design methods of ship power subsystems, we can also find considerations on the use of artificial intelligence methods in designing [3], [5], [6].

The ship's power plant includes many sets of machines and devices, pipelines, fittings, measuring, control and steering equipment. In the design practice of various shipyards and design offices engaged in ship automation, there is no single way to classify these devices. The ship's power subsystems can be divided into:

--main power systems:

--main propulsion (main engine, pitch propeller, gearbox, propeller shaft),

--power plant (generating set (generator, thyristor excitation system, voltage controller), shaft generator, power grid, receivers),

--thruster (induction motor, propeller shaft, controllable pitch propeller),

--installations (systems):

--engine room installations (fuel, lubricating oil, compressed air, exhaust gases, steam, outboard cooling water, fresh cooling water),

--generalship installations (bilge, ballast, sanitary, air-conditioning, ventilation, cooling, fire-fighting),

--auxiliary mechanisms (installation components):

--pumps, compressors, fans, condensers, filters and the like.

Ship automation systems include functions such as steering, regulation, control and safety.

Thrusters are one of the largest energy consumers on the ship; therefore, their activation significantly affects the operating parameters of the ship power system; and possible

failures can be life and property threatening. Therefore, it is important to select correct component elements of the thruster subsystem. The research, on the development of the hybrid expert system presented in the article, is focused on preparing a prototype application supporting the design of the thruster subsystem.

A possible reason for many costly breakdowns and accidents is the blackout during the cruise caused by overloading of the ship's power system. This threat is most likely to occur on dynamically positioned ships manoeuvring with the use of thruster or on manoeuvring with the use of thruster in enclosed waters. In dynamic positioning ships, the thruster works constantly. However, most problems are posed by connecting the ship thrusters to the power supply. During the blackout, the ship loses navigability and may collide with an obstacle. Therefore, correct selection of power system elements is very important. The paper focuses on manoeuvring with the use of thruster in enclosed waters with limited time.

The paper considers the design process of ship's thruster and ship's power plant subsystems. The design of the considered subsystems contains procedures like static and dynamic calculations and checking procedures if design solutions met the requirements of classification societies. Also, there are final report procedures which prepare technical drawings and a technical description.

The article contains issues related to the following design problems:

--collecting and providing numerical, textual and graphic information regarding catalogue data about elements and structures of the thruster subsystem,

--creating part of the technical description of the thruster subsystem, by preparing a document with the description of the structure and elements used in it,

--the selection of the thruster subsystem structure,

--the selection of the thruster structure elements,

--evaluation of static properties,

--evaluation of dynamic properties,

--estimating chosen costs of ship automation in the initial design stages,

--checking if design solutions met the requirements of classification societies.

The use of a hybrid expert system enables the support of initial stages of ship design (offer and contract design). Using the elements from the database in connection with the models from the library you can build the structure of ship's power subsystem, and then examine whether the subsystem meets the static and dynamic requirements of the classification society.

Determining static properties is relatively easy to do on the bases of the parameters of the elements contained in the database, but testing dynamic properties of the system requires simulation investigations and the library of mathematical models.

The bases for evaluating the design of the power system are classification societies rules, which set static and

dynamic requirements that must be met by elements and entire structures.

The use of simulation investigations and the expert system also allows to speed up the design process. The obtained design solutions are presented in the final report, which can be included, as a descriptive element of the design.

## II. RELATED WORKS

In many fields of technology where a design is necessary to create the product, there are attempts to develop specialized programs of computer-aided design using a knowledge base system. An example of such an attempt may be “An expert system prototype for designing natural gas cogeneration plants” developed by the research team from Brazil [7]. This system is used to create the concept and the preliminary design of a natural gas cogeneration plant. The system makes use of the CLIPS language (the ‘C’ Language Integrated Production System - developed by NASA to support the creation of expert systems) [8]. Another example of an expert system used in designing is “An expert system-based design of SCARA robot” developed by the research team from India [9]. This system allows the generation of SCARA (Selective Compliance Arm for Robotic Assembly) robot arm designs.

There are lots of system engineering methods, techniques and tools for ship design. Review of such systems we can find in [10] prepared by the research team from Malaysia.

There are also many attempts to use expert systems in ship design [11]. The issues related to their use are still actual. Here, “A submarine arrangement design program based on the expert system” developed by the research team from Korea [12] should be mentioned. This system supports submarine equipment selection and checks the submarine stability in the surfaced and submerged state. Another example is the “Expert System for Conceptual Design Ship’s Engine Room Automation (ESACD)” developed by the research team from China [13]. That prototype expert system was used to support the selection of ship engine room equipment and create a conceptual design based on the information about already existing ships. The present work is based on previous solutions, including “An expert system for aided design of ship systems automation” developed by the scientific team from Poland [14]. During system development, the Polish team used a skeleton application Exsys Developer [15] to prepare the system supporting the design process of ship automation at the offer, contractual, and technical design stages. The system uses fuzzy logic to generate design solutions similar to previous ones. The continuation of the research related to modelling of ship’s electric power subsystems at the Gdansk University of Technology resulted in the development of the application of the expert system for simulation investigations in the aided design of ship power system automation [16], [17]. Currently, systems are being developed at the Gdansk University of Technology that make use of machine learning and the multi-agent platform to support the design of ship power systems [5], [6], [18].

## III. HYBRID EXPERT SYSTEM METHOD FOR SHIP POWER SYSTEM DESIGN

To support designers at particular stages of ship design, the concept and then the hybrid expert system application was created. In the proposed solution, a standard expert system was improved by adding a simulation research module as the additional source of knowledge. The developed system focuses on ship power systems, in particular the thruster subsystem. Thrusters are one of the largest energy consumers on the ship; therefore, their activation significantly affects the operating parameters of the ship power system. The developed expert system application collects, in conversational mode, the information delivered by the user/designer. With the use of the parameters entered into the system, the structure and elements of the designed ship power subsystem are selected. During the design session, the expert system checks whether the selected structure and elements meet static requirements, and then outsource the simulation investigation to perform dynamic tests. The results of the simulation tests are evaluated by the expert system to check whether the structure and its elements meet the requirements of the classification society. Then the system generates the final report which, after approval by the design office, can be used as an offering design. At present, the developed application can also be used in further design stages, and in the future, after applying more complex and accurate mathematical models of structural components of the ship power system, will be able to be used to verify selected parts of contract, executive, and as-built designs. Fig. 1 shows the elements of the hybrid expert system supporting the ship power system design and functions of these elements. The expert system application has been implemented using the ExSys Developer program, a tool which permits faster creation of prototype expert systems. In addition, the developed system uses: the web application to present data about thruster structures, the external database implemented in the MS Access application, the library of mathematical models, and the simulation investigation module implemented in the Matlab/Simulink application. Parameters of mathematical model were chosen using the method of artificial intelligence: genetic algorithms.

## IV. THRUSTERS

Thrusters are used to support ship manoeuvrability in enclosed waters, as well as to keep a given position by special vessels (e.g. when laying a cable on the seabed, in rescue operations, or loading/unloading of goods and persons from an oil platform). Thrusters are one of the largest energy consumers on a ship. Usually, induction motors are used as thruster drives and their power can even exceed 1000 kW. The thrusters are most frequently placed in the prow part of the ship, as shown in Fig. 2. On special units with dynamic positioning systems, additional thrusters can also be installed in their aft part. Thrusters allow to keep the ship in given position and/or course, or rotate the ship around its vertical axis. Thruster’s efficiency decreases with the increase of ship speed; therefore, they are used only at low vessel speeds.

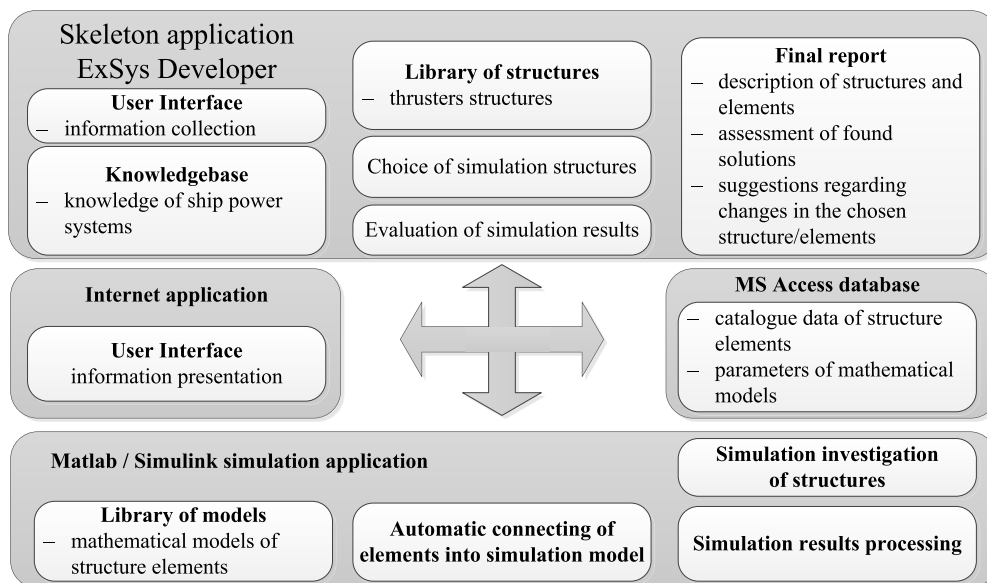

FIGURE 1. Elements of hybrid expert system supporting design of ship’s power subsystems.

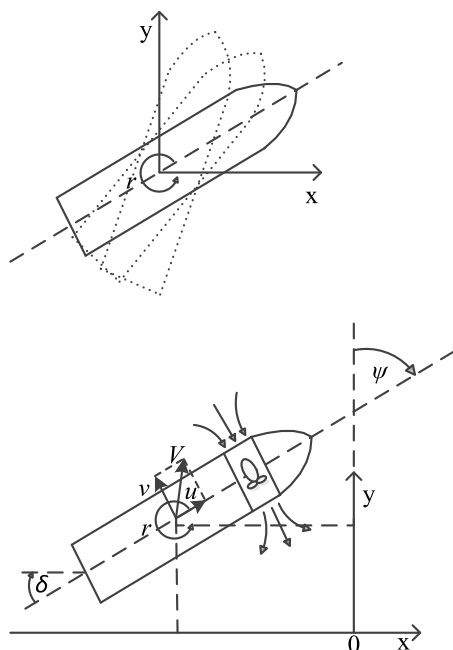

FIGURE 2. Ship manoeuvring with the use of bow thruster:  $x, y$  – coordinates of ship position,  $V$  – ship speed,  $u, v$  – components of ship velocity vector,  $r$  – angular velocity of ship turning,  $\psi$  – ship heading,  $\delta$  – rudder angle [19].

**A. STRUCTURE OF SHIP THRUSTERS**

Several types of thruster structures are used on ships. The simplest structure makes use of an induction motor started directly on-line. Other starting structures employ: star-delta switch (Fig. 3), autotransformer start-up, soft start, and a frequency converter.

**B. CONTROL PROBLEMS**

Ship thruster drives are time-activated energy receivers (in manoeuvring applications usually their work does not exceed

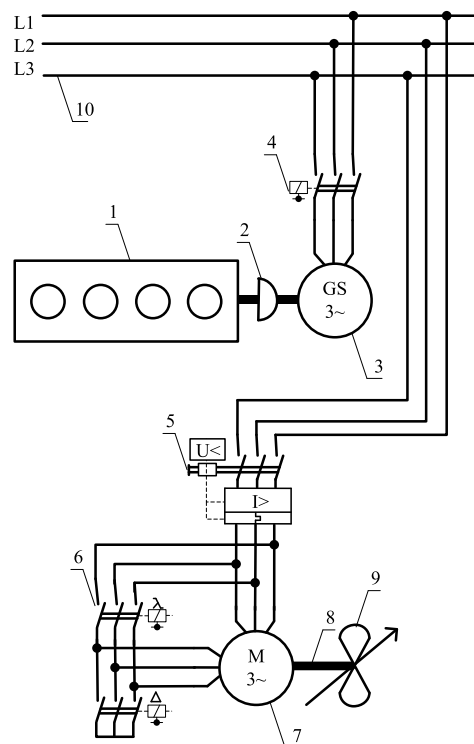

FIGURE 3. Exemplary thruster structure with star-delta starter: 1 – diesel engine, 2 – flexible coupling, 3 – synchronous generator, 4 – contactor, 5 – contactor with magneto-thermal protection, 6 – delta-star switch, 7 – induction motor, 8 – propeller shaft, 9 – controllable pitch propeller, 10 – main busbar.

30 minutes), and due to high power and start-up currents, they can negatively affect the operation of the ship’s electric power system. The starting current can be five times as high as the current consumed while the engine is run with maximum load. Therefore, it is very important to correctly choose the rated power of generators, taking into account the power consumed by thrusters and control systems to prevent power

MOST WIEDZY Downloaded from mostwiedzy.pl

failures, blackout for instance. Blackout during manoeuvring is a threat to human life and ship damage. The proposed expert system can help the designer to solve the design problems by automating static calculations and structure dynamics tests.

## V. DESIGNING

In designing, it is essential to execute the following tasks: system component selection, static and dynamic calculations, and evaluation of the chosen structure. The developed expert system application will help the designer in preparing the offer design and in further design stages.

### A. CHOICE OF THRUSTER STRUCTURE ELEMENTS

One of designer's tasks when preparing the design is selecting elements for the ship power subsystem. The list of elements to be selected includes: generators, motors, control systems, starting systems, protections, etc. This selection may cause problems for the designer. On the other hand, the set of devices delivered by one specialized producer is estimated to be more expensive by approx. 30% than a properly selected set of devices from different manufacturers/suppliers. This makes the individual selection effort fully justified.

### B. STATIC CONSIDERATIONS

The first step of selection of ship power system devices is performed based on static calculations. Due to specific features of the induction motor, in particular high starting current interfering with other loads of the ship's electric power system, and relevant requirements of classification societies, static calculations alone are not sufficient. Therefore, when selecting the electric system devices, the dynamics of individual components and the whole system should also be considered.

### C. DYNAMIC CONSIDERATIONS

Technically, precise dynamic tests of the ship's electric power system can be carried out when the unit is already built. However, taking into consideration short production series, high cost of such an operation, and the additional price of possible later changes in the system, this approach is economically unjustified. Therefore, physical and/or mathematical models are used to study the dynamics of the ship's electric power system.

### D. EVALUATION OF CHOSEN POWER SYSTEM STRUCTURE

Such factors as fast time-varying electrical receiver loads, weather conditions, etc. have significant impact on ship power system operation. The chosen structure of the ship electric power system is checked whether it meets the requirements of classification societies and expectations of a future shipowner.

### E. OFFER DESIGN

The offer design is created at the preliminary stage of the design process. It is only the proposal prepared by the design

office for a future shipowner and there is no guarantee that this proposal will be accepted. Therefore, developing a system supporting the designer at the offer design stage helps to reduce the cost of design procedures and to enable the submission of more offers responding to shipowner's queries. The offer design is usually based on the knowledge gained on previous design works, which allows preparing the design documentation faster. This documentation usually contains the main assumptions, the proposed solutions, and the estimated costs of project development and subsequent ship building.

## VI. DEVELOPED HYBRID EXPERT SYSTEM APPLICATION FOR DESIGNING THRUSTER SUBSYSTEMS

The application supporting the thruster subsystem design was developed as part of the application supporting the design of ship electric power subsystems. The developed system with knowledge base uses the Exsys Developer 8.0 application as a software application.

### A. STRUCTURE OF DEVELOPED HYBRID EXPERT SYSTEM APPLICATION

During the implementation of the expert system application, a number of its elements were prepared by the author:

- the expert system application – the ExSys Developer 8.0 application was used, which enables connecting all system elements and automating a large number of activities,
- the knowledge base regarding the requirements of ship power subsystems – the knowledge base contains the rules of classification societies and the resulting requirements for ship power subsystems,
- the library of thruster structures – the library contains structures discussed in Chapter 4A,
- the library of verified mathematical models,
- the module selecting parameters of mathematical models – the module uses the Matlab 6.0 application and genetic algorithms for selecting parameters of mathematical models of ship's power system elements [20],
- the database of structure elements – the database was implemented in the MS Access 2007 application and contains catalogued data of elements and parameters of verified mathematical models,
- the base of knowledge with instructions for the system user – the knowledge base contains detailed descriptions of thruster structures and the information necessary for the system user (e.g. designer) when working with the system,
- the system of automatic selection of elements from the library of models and linking them into simulation structures – an exemplary structure with elements juxtaposed and connected by the system is shown in Chapter 7 in Fig. 7,
- the subsystem of simulation investigations – the simulation investigation module was prepared in the Matlab/Simulink 6.0 application, the system makes use of simulation parameters delivered by the expert system application,

--the subsystem evaluating the results of simulation investigations – the simulation investigation results require extraction of knowledge necessary to evaluate the proposed solutions, therefore the results are processed and the chosen information is transferred to the expert system application as the additional source of knowledge,

--the expert system rule base which allows analysing the calculation and simulation results – the database contains the rules prepared based on the requirements of ship power subsystems. These rules make it possible to analyse and evaluate the results obtained from simulation investigations of structures (an exemplary rule is presented in Chapter 6F),

--the base of conclusions presented in the report to the user– the base contains conclusions that may appear in the report. The report can help the user/designer to modify the design proposal (exemplary conclusions are presented in Chapter 6G),

--the report generator – the report prepared by the expert system application can be used as part of the offer design or as part of the design in subsequent stages of design. The report contains: assumptions entered into the system in conversation mode, description of the chosen structure, descriptions of system elements, catalogue data of chosen elements, evaluation of the proposed design solutions, as well as conclusions and propositions of optional or necessary changes in the chosen solution (selected part of the report is presented in Chapter 7G).

**B. EXPERT SYSTEM APPLICATION IN EXSYS APPLICATION**

The expert system application for design support has been developed in the ExSys application. It was assumed that the designer’s work with the expert system application starts from the conversational mode, in which the designer, navigating through the menu, can go to the following modules (Fig. 4):

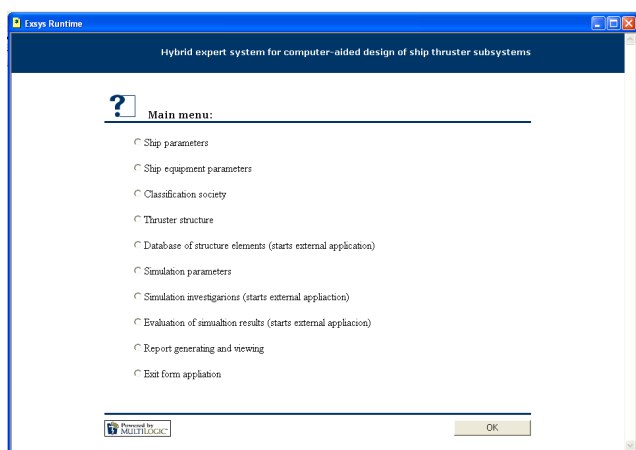

FIGURE 4. Main menu of application supporting the choice of ship thruster structure and elements.

- choice of ship parameters,
- choice of ship equipment parameters,
- choice of classification society,
- choice of thruster structure,

- viewing and updating the database of structure elements,
- selecting simulation parameters,
- starting the module of simulation investigations,
- starting evaluation of simulation results,
- generating and viewing the report,
- exit from the application.

The parameters entered into the system by the user are automatically saved and can be used in the next session. At start, the system has the pre-entered default parameters.

**C. SIMULATION INVESTIGATION MODULE**

The simulation investigations are performed in the Matlab/Simulink application by using mathematical models from the library of models (Fig. 5). The mathematical models of elements include model descriptions and parameters. The models chosen from the library are automatically linked into structures. The simulation investigations are carried out with parameters passed by the expert system application, and the simulation results are processed to extract the knowledge concerning the behaviour of relevant ship power systems. In particular, it is important to meet parameters required by classification societies.

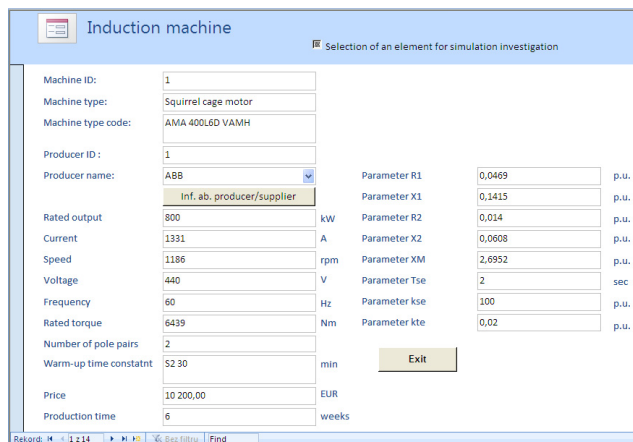

FIGURE 5. Catalogue card with data of chosen motor from component’s base of ship thruster structures, prepared in MS Access application.

**D. LIBRARY OF MATHEMATICAL MODELS**

To perform dynamic tests, it is necessary to build mathematical models of individual system elements with different complexity degrees and accuracy. At preliminary design stages, for example in the offer design, simplest mathematical models are used for rough selection of structure elements. A unique library of mathematical models of thruster structures has been developed in Matlab/Simulink application for this expert system application. The library contains models of such elements as Diesel engine, Diesel engine speed governor, synchronous generator, induction motor, induction motor taking into consideration losses in iron, induction motor taking into consideration losses in copper, hybrid induction motor, gearbox, torque summing gearbox, propeller shaft, power system load, controllable pitch propeller, controllable

MOST WIEDZY Downloaded from mostwiedzy.pl

pitch propeller in tunnel. The developed models can be easily combined with each other, and their parameters are chosen based on the catalogue data and the characteristics delivered by the suppliers. A special application using Genetic Algorithms was prepared for choosing parameters of mathematical models [20]. In the next design stages, it is postulated to use more accurate and, consequently, more time-consuming and expensive mathematical models.

### E. DATABASE

The database implemented in the MS Access application includes catalogue data of elements that can be part of the structure of the ship's thruster subsystem and parameters of their mathematical models. An example of the electric motor datasheet is shown in Fig. 5. It contains such elements as: engine type, name of producer, nominal data (power, current, speed, voltage, frequency, and torque), number of pole pairs, class, price, delivery/production time, and parameters of the mathematical model.

The evaluation of static properties of the designed thruster is based on the parameters of component elements included in the database.

The parameters of the mathematical models included in the database have been selected using the artificial intelligence method: genetic algorithms [20]. When selecting parameters for the elements, reference graphs supplied by the producer are used. The database can be easily updated.

### F. BASE OF RULES IMPLEMENTED IN EXSYS APPLICATION

The knowledge base of the expert system application includes a large number of rules. The exemplary Rule 50 concerns requirements of a given classification society. The Polish classification society PRS (Polish Register of Shipping) [1] sets the limitation on generator voltage changes in transient states, which cannot exceed  $\pm 0,2$  of nominal voltage, and on the time duration of changes, which cannot exceed 1.5 seconds.

On this basis, the following rule has been developed:

**IF**  $[DAT\_VG\_LD\_MOT\_IND] >$   
 $[PTK\_ACC\_DROP\_VG] * [DAT\_VG\_NO\_LD]$   
**THEN** „A structure did not meet the requirements (...)” –  
*Confidence 10/10* **ELSE** „The structure meets the  
 requirements (...)” – *Confidence 10/10*

where  $[DAT\_VG\_LD\_MOT\_IND]$  is the variable taken from simulation results (generator voltage drop after switching the load on by induction motor),  $[DAT\_VG\_NO\_LD]$  is the variable taken from simulation results (generator voltage with no load, in steady state),  $[PTK\_ACC\_DROP\_VG]$  is the variable corresponding to the regulations of the selected classification society (acceptable drop of generator voltage after switching the load on). The messages: “The structure did not meet the requirements (...)” and “The structure meets the requirements (...)” describe the achieved goals when generating the report. The coefficient “Confidence” describes the

confidence level of the achieved goal, e.g. 10/10 means that the solution is certain.

The expert system application contains a large number of rules, and the report is created based on these rules.

### G. CONCLUSIONS OF EXPERT SYSTEM APPLICATION

The Expert System knowledge base contains conclusions. An exemplary conclusion for the above described RULE 50 (Chapter 6 F) is:

--The structure with generator load at induction motor start does not meet the generator voltage drop limitation in transient states required by the chosen classification society. The temporary generator voltage drop after switching on the induction motor is  $[DAT\_VG\_LD\_MOT\_IND]\%$ . The permissible temporary generator voltage drop resulting from the regulations of the selected classification society is  $[PTK\_ACC\_DROP\_VG]\%$ . The voltage regulator settings should be re-chosen.

--The structure meets the generator voltage drop limitation in transient states (when the generator is loaded by the starting induction motor) required by the selected classification society.

The expert system application contains a large number of conclusions, and selected conclusions are included in the final report.

### VII. EXPERIMENTS

To evaluate the properties of the developed expert system application, an example of selecting the thruster structure and its components is presented. Both, the chosen thruster structure, and its component elements were verified by simulation investigations, the results of which are shown and discussed below.

#### A. ADOPTED ASSUMPTIONS

At the beginning of work with the expert system application, the system user introduces initial assumptions and parameters. In this investigation, the following ship parameters were set:

- wind force in Beaufort scale: =  $\{7^\circ B\}$ ,
- ship surface exposed to the wind =  $\{16500 \text{ m}^2\}$ ,
- ship length =  $\{285.5 \text{ m}\}$ ,
- distance between the ship's axis of rotation and the axis of tunnel thruster location =  $\{130 \text{ m}\}$ .

Based on these assumptions and using (1) and (2), the expert system application calculates the required torque and the thrust force generated by the thruster [21]:

$$M_c = \frac{P_w \cdot S_{bs} \cdot \gamma \cdot l_s}{2 \cdot 1000}, \quad (1)$$

where:  $M_c$  is the required moment of the thruster [kNm],  $P_w$  is the wind force [ $^\circ B$ ],  $S_{bs}$  is the lateral surface of the ship [ $\text{m}^2$ ],  $l_s$  is the ship length [m], and  $\gamma$  is the reducing factor [p.u.].

Then the user enters the distance of the ship's axis of rotation from the axis of tunnel thruster location. On this basis

and using (2), the thrust force to be generated by the thruster is calculated:

$$F_{thrust} = \frac{M_c}{l_{axis}}, \quad (2)$$

where:  $F_{thrust}$  is the thrust force required from the thruster [kN],  $l_{axis}$  is the distance between the axis of ship rotation and the axis of tunnel thruster location [m].

As the result of the performed calculations, the expert system application presented the following results:

- required torque generated by the thruster = {300310.31 kNm},
- required thrust force generated by the thruster = {2310.08 kN}.

In the next step, the user enters the parameters of the ship's electrical equipment: number of installed generators, power of each generator, as well as the length, cross-section, and conductivity of the power line.

The values of ship's electrical equipment parameters entered in this study were:

- number of installed generators = {3 pcs},
- power of each generator = {2800 kW},
- length of power line = {15 m},
- cross section of power line = {25 mm<sup>2</sup>},
- conductivity of power line = {58.6 S\*m/mm<sup>2</sup>}.

The number of the installed generators and their powers are optional parameters, as the expert system application can calculate them based on the entered ship parameters. However, when analysing a ship to be repaired, for instance, entering these data manually will allow comparing the calculated and real values, and, possibly, indicate the need to retrofit the ship with additional devices.

The user can select from the database a classification society whose requirements should be met by the investigated structure. In this case, the selected company was PRS (Polish Register of Shipping).

## B. CHOICE OF THRUSTER STRUCTURE AND ELEMENTS

In the next step, the user can optionally: select the complete thruster structure from available structures, or manually select individual structure elements from the model library. In this study, the thruster structure chosen from the database is the structure with direct start. Then the user moves to the database prepared in the MS Access application. This database contains elements which can be selected by the user during the simulation investigation session. The list of elements in the database includes:

- Diesel engine Type B400,
- Diesel engine speed governor Type B400,
- synchronous generator Type GDB10j-3500-6,3/50,
- thyristor excitation system and synchronous voltage controller Type GBD10j-3500-6,3/50,
- induction motor Type VAHM AMA400L4A,
- screw shaft Type-1w,
- screw with fixed or variable pitch Type-1s.

## C. SELECTION OF SIMULATION INVESTIGATION PARAMETERS

In the last step, the operator enters the simulation investigation parameters. The parameter values chosen for the present simulation were:

- start time of generator  $T_z = \{30 \text{ s}\}$ ,
- start time of induction motor  $T_{zs} = \{40 \text{ s}\}$ ,
- angle of blade screw pitch hp  $\alpha_{hp} = \{600\}$ ,
- time of switching on screw pitch A  $T_{zHpA} = \{60 \text{ s}\}$ ,
- time of switching on screw pitch B  $T_{zHpB} = \{70 \text{ s}\}$ ,
- time of switching screw off  $T_{wHp} = \{80 \text{ s}\}$ ,
- simulation time  $T_s = \{100 \text{ s}\}$ .

The adopted assumptions/parameters can be modified at any stage of application operation. The parameters entered by the user are stored in files, and they can be used as initial parameters in the next work session with the expert system application.

## D. SIMULATION INVESTIGATIONS

Choosing the option "Simulations investigations" from the main menu of the expert system application starts the Matlab/Simulink simulation application. This application uses the library of mathematical models described in Chapter 6D. The expert system application passes the files with the information about the chosen thruster structure to the simulation application. Based on this information, the simulation application initiates the earlier prepared scripts and automatically retrieves from the library mathematical models of elements composing the investigated structure. These models are automatically combined together by connecting their inputs to corresponding outputs. Fig. 6 shows the model of the investigated thruster structure automatically combined in the Matlab/Simulink application. The investigated model is of direct start type.

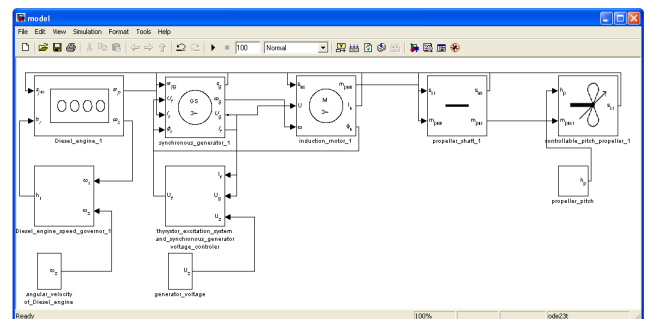
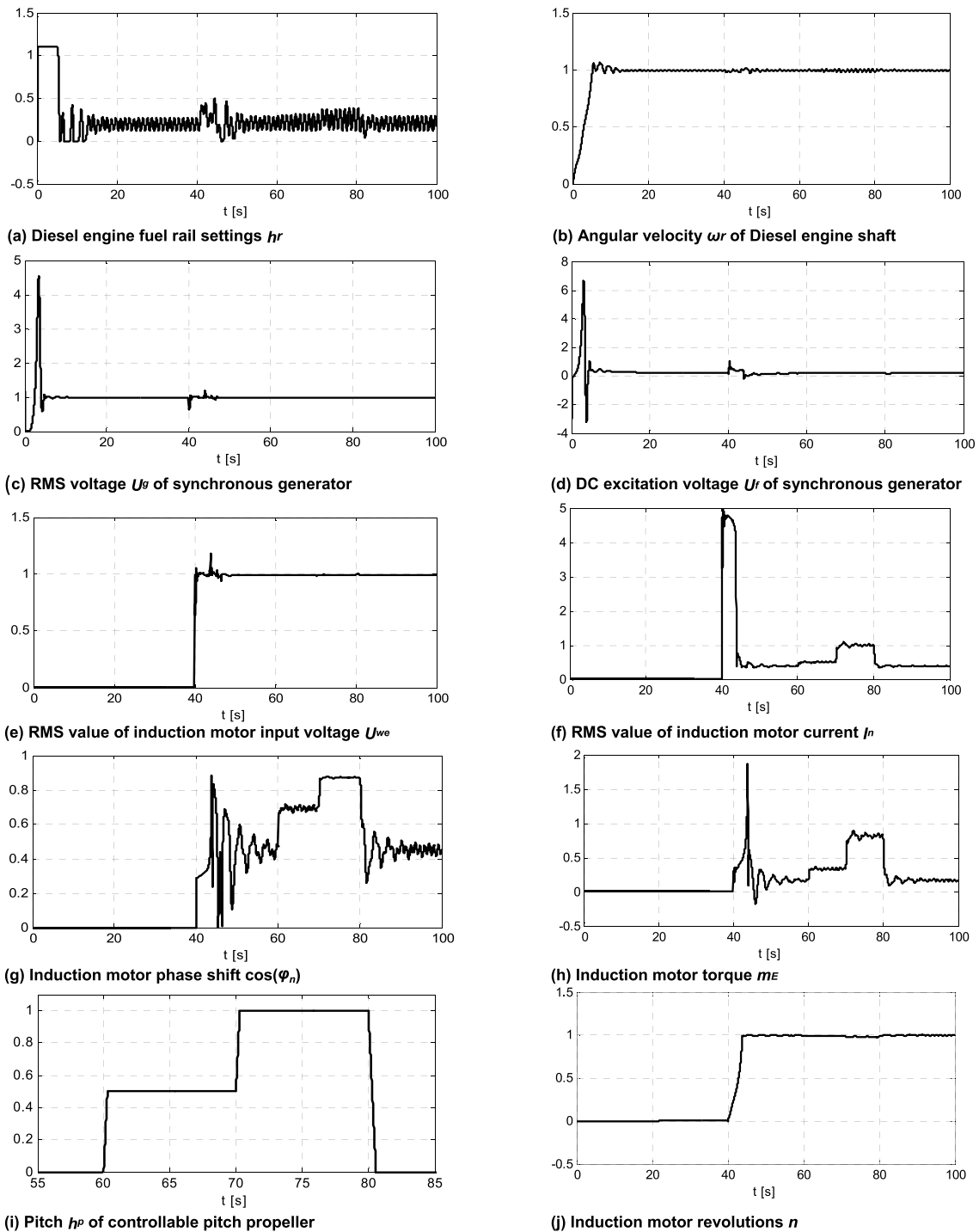

FIGURE 6. Structure of simulated power system – thruster subsystem.

The complete simulation model of the investigated structure is composed of the mathematical models of the following elements:

- Diesel engine,
- Diesel engine speed governor,
- synchronous generator,





**FIGURE 7.** Simulated waveforms received from ship's thruster subsystem simulation investigations. The x-axis in the diagrams represents time [s], while the y-axis [p.u.].

- thyristor excitation system and synchronous generator voltage controller,
  - induction motor,
  - propeller shaft,
  - controllable pitch propeller,
- and blocks setting the setpoints:
- propeller pitch,
  - generator voltage,
  - angular velocity of Diesel engine.

The simulation application takes parameters of mathematical models from the MS Access database, and simulation parameters from the files prepared by the expert system application.

**E. RESULTS OF SIMULATION INVESTIGATIONS**

As a result of the simulation investigation, a series of simulated waveforms is received.

The selected simulated waveforms shown in Fig. 7 represent:

- Diesel engine fuel rail settings  $h_r$ ,
- angular velocity  $\omega_r$  of the Diesel engine shaft,
- RMS voltage  $U_g$  of the synchronous generator,
- DC excitation voltage  $U_f$  of the synchronous generator,
- RMS value of induction motor input voltage  $U_{we}$ ,
- RMS value of induction motor current  $I_n$ ,
- induction motor phase shift  $\cos(\varphi_n)$ ,
- induction motor torque  $m_E$ ,
- pitch  $h_p$  of the controllable pitch propeller,
- induction motor revolutions  $n$ .

After completing the simulation investigation, the simulation application saves the simulation results and the model structure in files to allow their further processing.

### F. EVALUATION OF CHOSEN THRUSTER STRUCTURE

When evaluating the chosen structure, relevant information should be extracted from the obtained simulation results. For this purpose, the simulation results are processed by the developed application, which automatically reads the information from the plots and saves it in the text file. For example, from the plot showing the induction motor current  $I$ , the application reads: the maximum value of the starting current, the start-up time of the induction motor, and the increase of the current consumed by the motor after switching the load on. This data is used by the expert system application to evaluate the chosen structure of the thruster. These results will also be included in the prepared final report. Finally, the developed system compares the obtained results with the requirements of the selected classification society, e.g. PRS [1] and presents conclusions.

For example, the PRS (Polish Register of Shipping) classification society sets the limitation for the generator voltage changes in transient states, which should not exceed  $\pm 0.2$  of nominal voltage. After such a voltage change, the generator must restore the voltage to the nominal value, with the tolerance of  $\pm 4\%$ , and the time of change cannot exceed 1.5 seconds.

According to the PRS requirements, in the steady state the controller should keep the set angular speed of motor shaft. In transient states, temporary overshooting may occur but they should not exceed 5% of the rated value. The PRS regulations require that the voltage regulator works astatic and keeps the nominal value. The designs of AC generators should allow them to withstand the 50% overload current for 120 s.

The following parameters were read from the simulated waveforms shown in Fig. 8:

- maximum starting current  $I_n$  of the induction motor no. 1:  $I_n = 4.80$  [pu],
- start-up time of the induction motor no. 1:  $T_r = 3.87$  [s],
- induction motor speed decrease  $\Delta n$  after switching on screw no. 1 with pitch A:  $\Delta n = 0.58$  [%],
- induction motor speed decrease  $\Delta n$  after switching on screw no. 1 with pitch A:  $\Delta n = 1.52$  [%],

```

Introduced initial assumptions and parameters:
- wind force in Beaufort scale: =(7),
- ship surface exposed to the wind = {16500 m2},
- ship length = (285.5 m),
... distance between the ship's axis of rotation and the axis of tunnel thruster location = (130 m).

Ship parameters calculated by the expert system application:
- required torque generated by the thruster = {300310,31 kNm},
- required thrust force generated by the thruster = {2310.08 kN},
- necessary number of thrusters to create the required thrust force: 4 [pcs].

Selected thruster from the ABB catalogue:
- type of ABB thruster: CPT 2.75,
- required force of single thruster: 318 [kN],
- maximum drive power of thruster: 2200 [kW],
- frequency: 50 [Hz].

The Values of ship's electrical equipment parameters are:
- number of installed generators = {3 pcs},
- power of each generator = {2800 kW},
- length of power line = (15 m),
- cross section of power line = {25 mm2},
- conductivity of power line = (58,6 S*m/mm2).

The thruster structure chosen from the database is the structure with direct start.

Elements of structure chosen are:
- Diesel engine,
- Diesel engine speed governor,
- synchronous generator,
- thyristor excitation system and synchronous generator voltage controller,
- induction motor,
- propeller shaft,
- controllable pitch propeller.

Results of simulations investigation making use of external evaluation application:
- maximum starting current  $I_n$  of the induction motor no. 1:  $I_n = 4.80$  [pu],
- start-up time of the induction motor no. 1:  $T_r = 3.87$  [s],
- induction motor speed decrease  $n$  after switching on screw no. 1 with pitch A:  $n = 0.58$  [%],
- induction motor speed decrease  $n$  after switching on screw no. 1 with pitch A:  $n = 1.52$  [%],
- induction motor torque  $T_e$  without load:  $T_e = 0.18$  [pu],
- induction motor torque  $T_e$  with load screw no. 1, with pitch A:  $T_e = 0.34$  [pu],
- induction motor torque  $T_e$  with load screw no. 1, with pitch B:  $T_e = 0.83$  [pu],
- generator voltage  $U_g$  without load:  $U_g = 0.99$  [pu],
- generator voltage drop  $U_g$  after switching on the induction motor no. 1:  $U_g = 35.89$  [%],
- generator voltage drop  $U_g$  after switching on screw no. 1 with pitch A:  $U_g = 0.03$  [%].

```

FIGURE 8. Part of report file prepared by expert system – chosen assumptions and simulation results.

- generator voltage drop  $\Delta U_g$  after switching on the induction motor no. 1:  $\Delta U_g = 35.89$  [%],
- generator voltage drop  $\Delta U_g$  after switching on screw no. 1 with pitch A:  $\Delta U_g = 0.03$  [%].

After comparing the obtained data with PRS regulations, the following conclusions can be extracted:

- the starting current of the induction motor is excessively high compared to the generator current, another thruster structure, for instance with star-delta start-up of the induction motor, should be considered.
- the structure with generator load at induction motor start does not meet the generator voltage drop limitation in transient states required by the chosen classification society. The temporary drop of generator voltage after switching on the induction motor is 35.89%, while the permissible drop resulting from the regulations of the selected classification society is 20%.
- voltage regulator settings should be re-chosen.

### G. FINAL REPORT

The text of the final report is generated automatically. A chosen fragment of the report is shown in Figs. 8 and 9.

The report contains such information as:

- initial data (shipyard name, ship's type and deadweight, contact person, version of the expert system application),
- the selected classification society,
- design assumptions,
- ship's parameters calculated by the system,
- example of choosing the thruster from the ABB catalogue,

- number of generators installed on the ship are too small. According to the regulations of the chosen classification society, it should be at least one backup emergency protective generator installed,
- install 2 new generators,
- the starting current of the induction motor is excessively high compared to the generator current, another thruster structure, for instance with star-delta start-up of the induction motor, should be considered,
- the structure with generator load at induction motor start does not meet the generator voltage drop limitation in transient states required by the chosen classification society. The temporary drop of generator voltage after switching on the induction motor is 35.89%, while the permissible drop resulting from the regulations of the selected classification society is 20%.
- voltage regulator settings should be re-chosen.

**FIGURE 9. Part of report file prepared by expert system – chosen conclusions.**

- parameters of the ship's electrical equipment,
- the chosen thruster structure,
- description of elements of the selected thruster structure,
- results of simulation investigations making use of the external evaluation application,
- final conclusions of the expert system application.

The report also contains the information about ship's parameters calculated by the expert system application, the example of the thruster selection, parameters of chosen ship's equipment elements, conclusions, ship's data, and user parameters.

The designing is an iterative process. After preparing the report by the system, the user can change selected parameters and ship's data, and then re-run simulation investigations to obtain a new report. This process is repeated until the expected results are achieved.

## VIII. CONCLUSIONS AND FUTURE RESEARCH DIRECTIONS

Ship designers show interest in systems supporting the choice of devices composing thruster structures. Their experience shows that free choice of thruster's component elements produced by different manufacturers can reduce the cost of ship's electrical equipment by up to several tens per cent. At the same time, designers are reluctant to admit that emerging design errors cause a need to perform costly repairs, which extend the time needed to put a finished ship into service.

Due to system dynamics requirements, the effect of the presence of a selected element in the system is not known a priori. Even if the dynamics of each individual element is known, the dynamics of the whole system cannot be assessed precisely. Manufacturers and suppliers of ship's power subsystem components have developed their own procedures for combining these elements into one set. Companies that produce sets of electric subsystem elements have the knowledge obtained from researching their products on how to combine these elements. They have incurred huge costs for developing those procedures. As a result, buying components from such a manufacturer is more expensive, as the price includes not only the cost of elements alone, but also the cost of knowledge how to compose the whole system. That is why companies supplying elements of ship's power subsystems (e.g. a thruster subsystem) keep selection procedures as company secret. For the entire ship's electric power subsystem, this secret information

increases the cost of the set of elements by approx. 30%, according to estimates by designers.

The application of simulation investigations in the design process can:

- facilitate solving design problems,
- enable analysing transient and steady states,
- help in reducing the cost of the design process and the purchase cost of individual structure elements,
- facilitate cooperation with subcontractors in the design and construction process,
- allow creating virtual designs.

The above opinion is confirmed by the developed procedures supporting the analysis and design of ship's thruster subsystems, based on simulation investigations and the knowledge base system.

The paper presents a draft of the elements of the hybrid expert system and discusses some them i.e.:

- the user interface,
- the library of thruster structures,
- the database of structure elements,
- the library of mathematical models,
- the knowledge base with exemplary rules,
- the example of simulation investigations and evaluation of simulation results,
- the final report contains, among others: catalogue data of elements, evaluation simulated structure, and conclusions.

In the paper we have used the simplest mathematical models for rough selection of structure elements, more details about mathematical models adopted for the simulation investigations and their reliability can be found in [19]–[21]. The simplified mathematical models of structure elements, used in the simulations have adequacy (calculated by using integral and/or absolute values criteria) at a few per cent level. In the higher design stages, it is postulated to use more accurate and, consequently, more time-consuming and expensive mathematical models. The purpose of using mathematical models was to check whether the analyzed structure meets the requirements of the classification societies. The models used here are not very accurate, but they reflect physical processes (occurring in the component elements of the thruster subsystem). As far as possible, the parameters of the models were chosen to obtain the best possible properties of the models in relation to physical elements. The purpose of using the models was to obtain an answer regarding the usefulness of given structures and elements in relation to the requirements of classification societies.

The developed hybrid expert system performs the following functions:

- collecting and providing numerical, textual and graphic information regarding catalogue data about elements and structures of the thruster subsystem,
- creating part of the technical description of the thruster subsystem, by preparing a document with the description of the structure and elements used in it,
- the selection of the thruster subsystem structure,
- the selection of the thruster structure elements,

- the estimating chosen costs of ship automation in the initial design stages,
- checking design solutions by simulation investigations based on the use of mathematical models of power system elements,
- checking if design solutions met the requirements of classification societies.

From the shipyard's point of view, the use of a hybrid expert system in design will enable us to shorten the design cycle and reduce the design cost of the thruster subsystem. Using the system in the design office can additionally improve the quality of design solutions and documentation (more readable documents, fewer errors). Artificial intelligence methods in the design process can also streamline the cost estimation process for the initial design stages, and reduce the ship automation costs by choosing optimal equipment suppliers. Obtained correct design solutions can be prepared without model tests on real objects by the system.

The use of the discussed hybrid expert system makes it very easy to combine different types of elements into the entire subsystem and to test the obtained solution. It also makes it possible to automate design by using algorithms to combine elements and to evaluate the obtained results. The increase in the efficiency is associated with the fact that without human intervention, you can get solutions and consequently conduct further research with humans. Also, the introduction of appropriate algorithms allows for the selection of automatically generated design solutions.

Automating processes of model linking and information transfer between expert system modules, as well as final rapport preparation, can be especially useful at initial design stages. The generated reports can be used as the source of information and/or as formal design attachments. More advanced reporting systems, expected to be developed in the future, may contain commands that automatically create designs (technical drawings) in CAD (Computer Aided Design) systems.

Developing a commercial system is time consuming and expensive. It requires extract expert knowledge, which is not always easy, and the use of expensive complex models. At present, it seems unprofitable to build such a system for one shipyard. Additionally, the discussed system requires permanent updating. However, in the future, automatic design support systems will increasingly reduce human participation in the design process.

Currently, the research is being carried out on machine learning and multi-agent systems facilitating and accelerating the work with extensive expert systems intended to support the design.

## REFERENCES

- [1] The Polish Register of Shipping. (2019). *Classification Rules*. Accessed: Aug. 1, 2019. [Online]. Available: <https://www.prs.pl/prs-rules-and-publications/classification-rules.html>
- [2] American Bureau of Shipping. (2019). *Classification Rules*. Accessed: Oct. 18, 2019. [Online]. Available: <https://ww2.eagle.org/en.html>

- [3] Z. Kowalski, "System z bazą wiedzy dla wspomagania projektowania układów automatyki okrętowej," Gdańsk Univ. Technol., Gdańsk, Poland, Tech. Rep., 2000.
- [4] J. H. Evans, "Basic design concepts," *J. Amer. Soc. Nav. Eng.*, vol. 71, no. 4, pp. 671–678, Mar. 2009.
- [5] R. Arendt, A. Koczyński, and P. Spychalski, "Centralized and distributed structures of intelligent systems for aided design of ship automation," in *Proc. 38th Int. Conf. Inf. Syst. Archit. Technol. Inf. Syst. Archit. Technol. (ISAT)*, in Advances in Intelligent Systems and Computing, vol. 656. Cham, Switzerland: Springer, 2018, pp. 310–319. [Online]. Available: [https://link.springer.com/chapter/10.1007%2F978-3-319-67229-8\\_28](https://link.springer.com/chapter/10.1007%2F978-3-319-67229-8_28)
- [6] P. Spychalski and R. Arendt, "Machine learning in multi-agent systems using associative arrays," *Parallel Comput.*, vol. 75, pp. 88–99, Jul. 2018.
- [7] J. A. Matelli, E. Bazzo, and J. C. da Silva, "An expert system prototype for designing natural gas cogeneration plants," *Expert Syst. Appl.*, vol. 36, no. 4, pp. 8375–8384, May 2009.
- [8] *CLIPS: A Tool for Building Expert Systems*. Accessed: Apr. 10, 2019. [Online]. Available: <http://clipsrules.sourceforge.net/>
- [9] P. Bhatia, J. Thirunarayanan, and N. Dave, "An expert system-based design of SCARA robot," *Expert Syst. Appl.*, vol. 15, no. 1, pp. 99–109, Jul. 1998.
- [10] T. K. Jauhari, A. Maimun, and C. L. Siow, "Review of Systems Engineering Methods, Techniques and Tools for Ship Design as Large and Complex Systems," in *Proc. Int. Congr. Conf. Comput. Des. Eng.*, vol. 3, 2019, pp. 82–91.
- [11] J.-H. Park and R. L. Storch, "Overview of ship-design expert systems," *Expert Syst.*, vol. 19, no. 3, pp. 136–141, Jul. 2002.
- [12] K.-S. Kim and M.-I. Roh, "A submarine arrangement design program based on the expert system and the multistage optimization," *Adv. Eng. Softw.*, vol. 98, pp. 97–111, Aug. 2016.
- [13] X.-Y. Shao, X.-Z. Chu, H.-B. Qiu, L. Gao, and J. Yan, "An expert system using rough sets theory for aided conceptual design of ship's engine room automation," *Expert Syst. Appl.*, vol. 36, no. 2, pp. 3223–3233, Mar. 2009.
- [14] Z. Kowalski, R. Arendt, M. Meler-Kapcia, and S. Zieliński, "An expert system for aided design of ship systems automation," *Expert Syst. Appl.*, vol. 20, no. 3, pp. 261–266, Apr. 2001.
- [15] Exsys Inc. *The Expert System Experts*. Accessed: Apr. 10, 2019. [Online]. Available: <http://www.exsys.com/>
- [16] R. Arendt, "Application of models of ship power subsystems," *Przegląd Elektrotechniczny*, vol. 87, no. 8, pp. 206–211, 2011.
- [17] R. Arendt, "The application of an expert system for simulation investigations in the aided design of ship power systems automation," *Expert Syst. Appl.*, vol. 27, no. 3, pp. 493–499, Oct. 2004.
- [18] R. Arendt and P. Spychalski, "An application of multi-agent system for ship's power systems design," in *Proc. 20th Int. Conf. Transp. Means*, 2016, pp. 380–384.
- [19] A. Koczyński, "Mathematical models in design process of ship bow thrusters," in *Proc. 20th Int. Sci. Conf. Transp. Means*, 2016, pp. 328–331.
- [20] A. Koczyński, R. Arendt, and M. Wojtczak, "The choice of parameters of induction motor model using a genetic algorithm," in *Proc. 10th IEEE Int. Conf. Methods Models Autom. Robot.*, Jun. 2004, pp. 143–148.
- [21] A. Koczyński, "Analysis and design of control systems of ship thrusters with a knowledge-based system," Ph.D. dissertation, Gdańsk Univ. Technol., Gdańsk, Poland, 2015.



**ANDRZEJ KOCZYŃSKI** received the M.Sc. and Ph.D. degrees in control engineering and robotics from the Gdańsk University of Technology, in 2002 and 2015, respectively. He is currently an Assistant Professor with the Department of Control Engineering, Gdańsk University of Technology. His current research interests include expert systems, mathematical modeling, and computer aided design systems.

...