

# CFD SIMULATIONS AND TESTS OF A PROTOTYPE FLOW CONTROL VALVE

Marta Zaleska-Patrosz<sup>1</sup>[0000-0002-9025-5589], Piotr Patrosz<sup>2</sup>[0000-0002-8711-7062],  
Paweł Śliwiński<sup>2</sup>[0000-0003-1332-3661]

<sup>1</sup> BIBUS MENOS, Spadochroniarzy 18,80-298 Gdansk, Poland

<sup>2</sup> Gdansk University of Technology, Faculty of Mechanical Engineering,  
Narutowicza 11/12, 80-233 Gdansk, Poland

## Abstract.

In this paper a prototype of a flow control valve is described and numerically simulated. The flow control valve is used in hydraulic systems to maintain constant fluid flow despite changing loads of a receiver. The standard construction of this type of valves is modified mainly by eliminating the spring. The prototype consists the hydrostatically unloaded throttle valve and pressure ratio valve substituting pressure difference valve. The article concentrates on numerical simulation conducted for different positions of pressure ratio valve's spool and various throttle valve settings. Additionally the rotation of the spool is included in simulation and its influence on valve's characteristics is evaluated. The article also describes the methodology of determining flow characteristics of control valve. Results from numerical simulation are compared to results of experimental research.

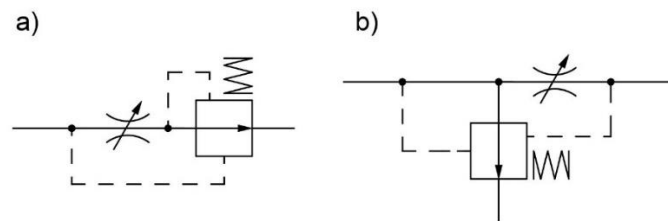
**Keywords:** Flow control valve, Numerical simulation, CFD, Hydraulics, Fluid Dynamics

## 1 Introduction

The flow control valve is used in hydraulic systems to maintain constant fluid flow rate through the receiver, for example hydraulic motor or cylinder, despite pressure changes. The flow control valve consists of an adjustable throttle valve and a differential valve [1].

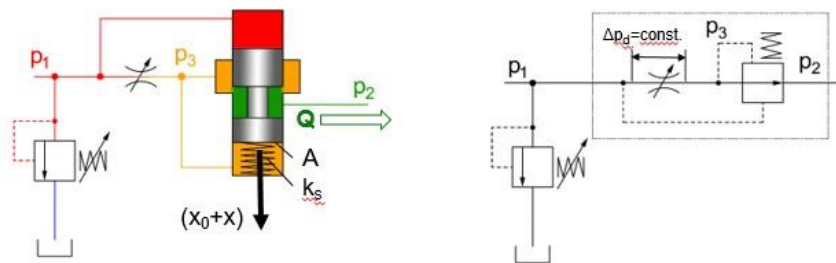
There are two types of flow control valves: two- or three-way flow control valve (Fig.1).

In both types of flow control valves the differential valve maintains constant pressure drop on the throttle valve. However, in two-way flow control valve the differential valve is placed in-line with the throttle valve, whereas in three-way flow control valve the differential valve is parallel to the throttle valve [2]. Due to the features mentioned above the two-way flow control valve is always used with pressure relief valve and the three-way control valve can be used as standalone valve.



**Fig.1.** Scheme of: a) the two-way flow control valve, b) three-way flow control valve.

This article concentrates on two-way flow control valves. The differential valve can be placed either in front or after the throttle valve. The configuration of these two valves does not change the principal of operation [3] therefore only one configuration is presented in Fig. 2 and taken into further considerations.



**Fig.2.** Scheme of the two-way flow control valve.

Pressure  $p_1$  in front and pressure  $p_3$  behind throttle valve are used as control signals and act on surfaces of the spool. The spool is supported by the spring therefore the pressure drop equation on the throttle valve is described by formula:

$$\Delta p_d = p_1 - p_3 = \frac{k_s(x_0+x)}{A} \quad (1)$$

where:

$p_1$  – pressure at the inlet to the flow control valve, adjusted by pressure relief valve,

$p_3$  – pressure after the throttle valve,

$A$  – area of frontal surfaces of the spool,

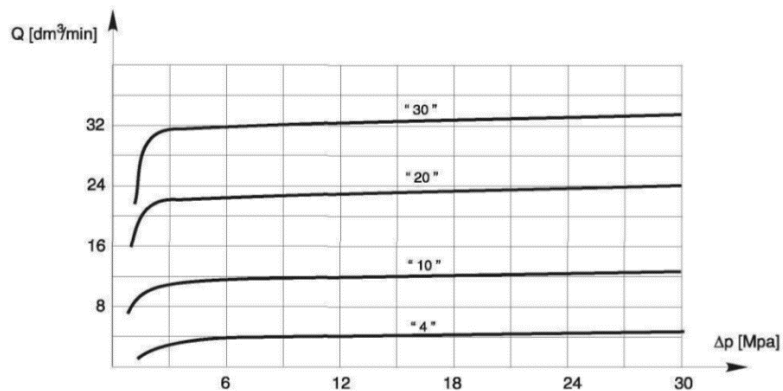
$k_s$  – spring constant,

$x_0$  – initial deflection of the spring,

$x$  – spool's displacement.

As it is shown in Fig. 3 the real characteristic of flow rate through the flow control valve is not constant as it is expected. It is caused by the fact that spool's

displacement  $x$  increases the force in the spring, which changes the pressure drop  $\Delta p_d$  and affects the flow rate.

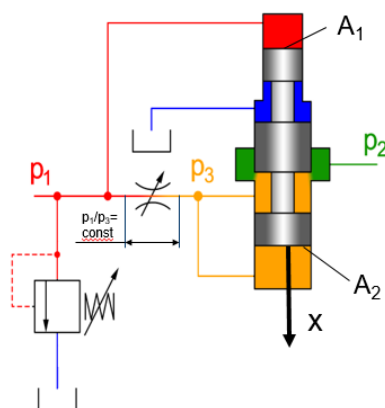


**Fig.3.** Characteristics of flow rate  $Q$  in function of  $\Delta p$  for valves type UDRN6, produced by Ponar Wadowice, for different valve sizes [4].

The flow control valve without this fault was designed at Gdansk University of Technology [5].

### 1.1 Description of the prototype flow control valve

Design of the prototype flow control valve is based on a substitution of a standard pressure differential valve with a pressure ratio valve (Fig.4). The main difference between pressure ratio valve and differential valve is the fact that pressure ratio valve does not have spring and the constant pressure difference  $\Delta p_d$  is obtained thanks to difference between area of surface  $A_1$  and  $A_2$ . Higher pressure  $p_1$  acts on the smaller surface  $A_1$  and lower pressure  $p_3$  acts on the bigger surface  $A_2$ .



**Fig.4.** Scheme of the prototype flow control valve [5].

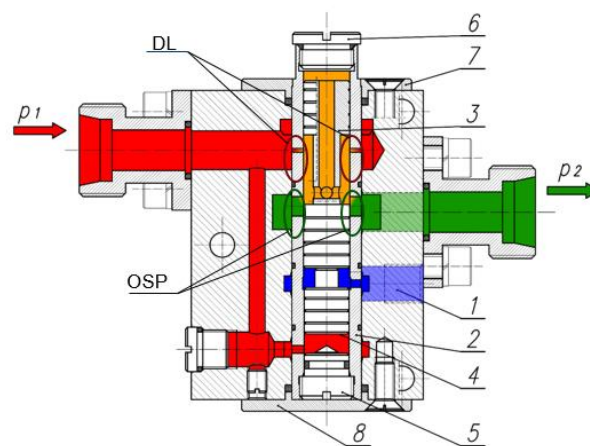
Due to the fact that the ratio  $A_1/A_2$  is always constant,  $\Delta p_d$  is given by the equation:

$$\Delta p_d = p_1 \left( 1 - \frac{A_1}{A_2} \right) \quad (2)$$

As long as pressure  $p_1$ , set by relief valve, remains constant,  $\Delta p_d$  also remains constant, independently of the spool displacement.

The prototype flow control valve shown in Fig. 5 consists of:

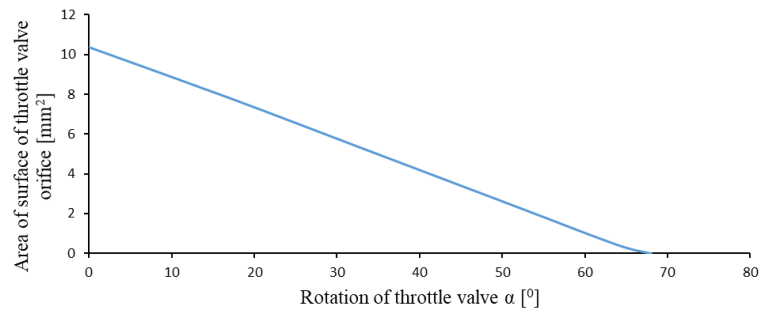
- valve housing (1),
- sleeve (2),
- main spool (3),
- auxiliary spool (4),
- throttle valve orifice (DL),
- pressure ratio valve orifice (OSP).



**Fig.5.** Flow control valve with pressure ratio valve [6].

In comparison to standard flow control valve one of the most important advantage is to prevent the impact of the spring's deflection on flow rate. Thanks to using the pressure ratio valve instead of the differential valve, there is a possibility to gain more constant characteristic, which is similar to theoretical characteristic. The throttle valve is a rotary tube with bean-shaped orifice, which can change its opening area when the tube is rotated by an angle between  $0^\circ$  and  $68^\circ$  (Fig.6).

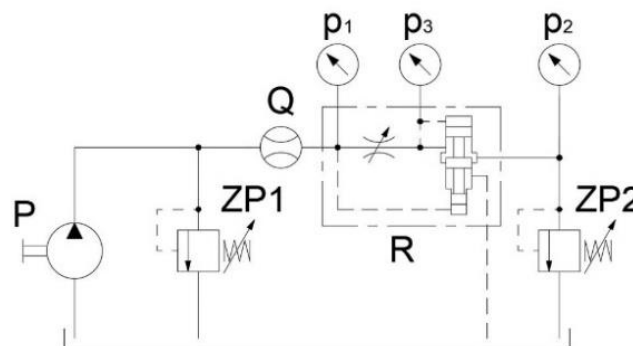
The prototype is characterized by simple construction and small size. The prototype flow control valve could be used in these branches of industry, where constant input pressure is provided for ex. in mining.



**Fig.6.** Relation between area of surface of throttle valve orifice and rotation of throttle valve  $\alpha$ .

## 2 Laboratory tests of the prototype flow control valve

Laboratory tests were conducted at Gdansk University of Technology under supervision of prof. Paweł Śliwinski. Scheme of a test bench is shown in Fig.7.



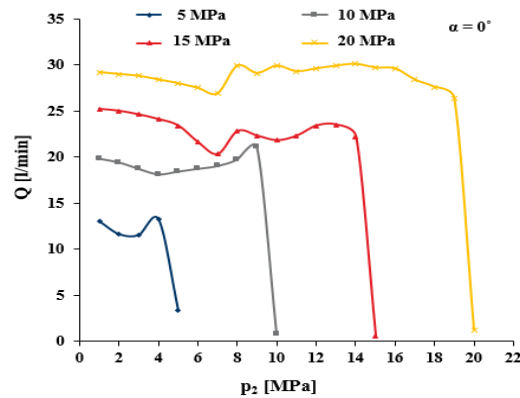
**Fig.7.** Scheme of the test bench.

During laboratory tests, the flow rate was measured depending on:

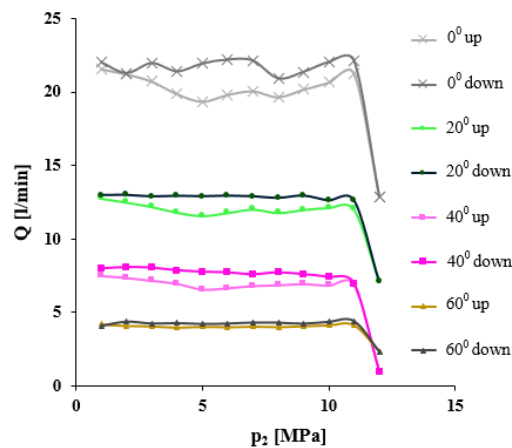
- increase (in characteristics described as “up”) or decrease (in characteristics described as “down”) of load pressure  $p_2$ ,
- adjustment of inlet pressure  $p_1$ ,
- different throttle valve settings  $\alpha$ .

Results of laboratory tests (Fig.8-9) show, that there are two main problems in operation of the prototype flow control valve. First of all, the flow characteristics is not stable in the whole range of load pressure (Fig.8). Characteristic collapse is repeatable but cause of its occurrence is so far unknown. Secondly, the hysteresis between increase and decrease of load pressure  $p_2$  is noticeable and significant (Fig.9). Additionally, after disassembly of the prototype it was discovered that surfaces of the spool had peripheral scratches, which means that the spool rotates [7].

This is a positive phenomenon but until CFD simulations were conducted, the impact of rotation on the flow rate had been unknown (Fig.14).



**Fig.8.** Flow characteristics of the prototype flow control valve [8].



**Fig.9.** Flow characteristics during increase(up) and decrease (down) of load pressure  $p_2$  [8].

### 3 CFD Simulations

CFD (Computational Fluid Dynamics) analysis are used to investigate flow phenomena inside valves. Since the valve presented in this article is a prototype, there are no publications considering it. However, there are several articles, which consider modeling flow control valves with differential valve [9, 10]. Additionally articles presenting CFD models of spool valves [11,12] proved to be helpful in understanding the phenomena, which occur during operation of researched flow control valve.

### 3.1 Flow control valve mesh

In order to investigate the prototype flow control valve, Ansys CFX software was used. During preparation of computational model it was necessary to create an appropriate mesh of fluid filling channels of the flow control valve.

One of the problems which always appears in CFD simulation is how to get a compromise between size of elements, hence accuracy of simulation, and time of simulation. In this case it was essential to get as dense mesh as possible in some parts of model, e.g. near walls and orifices, but in other parts it was not so crucial. Model consists of tetrahedron elements, which size depends on position of the spool and rotation of the sleeve. It means that the smaller orifices DL and OSP (Fig.5) were, the more precise mesh was. The overall quantity of elements varied from 765188 to 934298 depending on analyzed configuration.

Figure 10 presents a mesh of the interior of the prototype flow control valve.

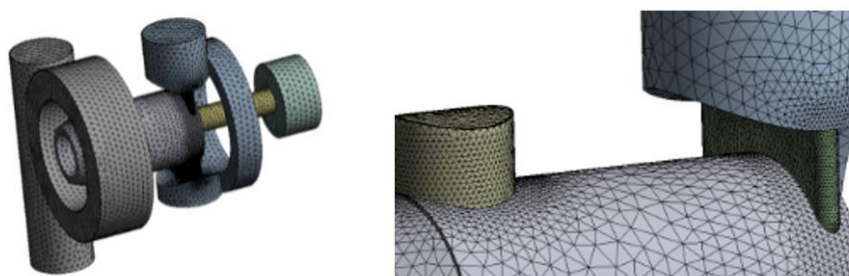


Fig.10. Mesh of fluid inside the flow control valve.

### 3.2 Simulation assumptions and boundary conditions

In order to simplify the calculations, initial assumptions were made as follows:

- irrelevant geometric details, for ex. drill cones and screw-threads, were excluded,
- temperature inside the prototype flow control valve was constant,
- fluid was incompressible,
- single-phase flow was set.

Following boundary conditions and solver configurations were set:

- inlet/outlet: opening type,
- turbulence model: Shear Stress Transport (SST),
- type of analysis: Steady State,
- rotation of selected walls: 2 000 rpm,
- fluid: hydraulic oil: density  $860 \text{ [kg/m}^3]$ , viscosity  $\nu = 46 \text{ [mm}^2/\text{s}]$ .

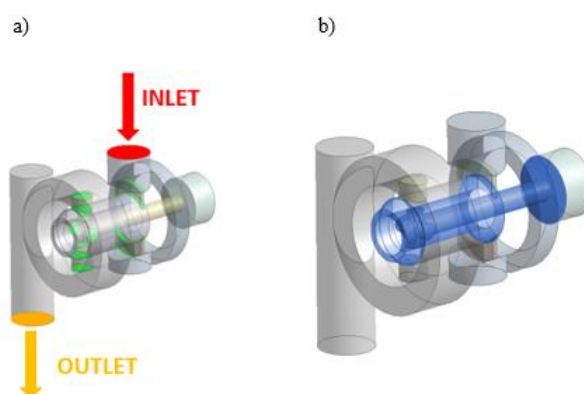
Opening boundary condition for inlet and outlet was selected. It allowed the fluid to flow in both directions in case of vortex near to boundary.

Chosen turbulence model SST which is described in [13,14,15] combines two models:  $k-\omega$  and  $k-\epsilon$ . Near walls  $k-\omega$  is used. Away from walls  $k-\epsilon$  is used. The transition between these models is defined using blending function. The SST model

was selected because it proved to be more stable and converge faster than  $k-\omega$  and  $k-\epsilon$  models.

Rotation of chosen walls was intentionally set so high (2000 rpm) in order to investigate if that rotation has significant influence on flow rate.

Figure 11 presents location of inlet (red surface), outlet (yellow surface), interfaces between domains (green surfaces) and location of rotating walls (blue surfaces) in computational model.

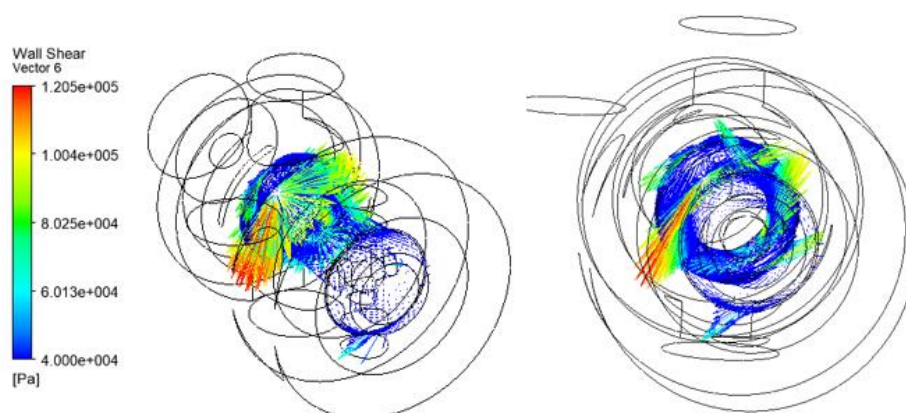


**Fig.11.** Boundary conditions: a) location of inlet, outlet and interfaces, b) location of rotating walls.

### Rotation of the spool

Due to the fact that laboratory tests showed that the spool rotates [7], the CFD analysis were conducted to determine, if the rotation of the spool can have influence on the flow rate.

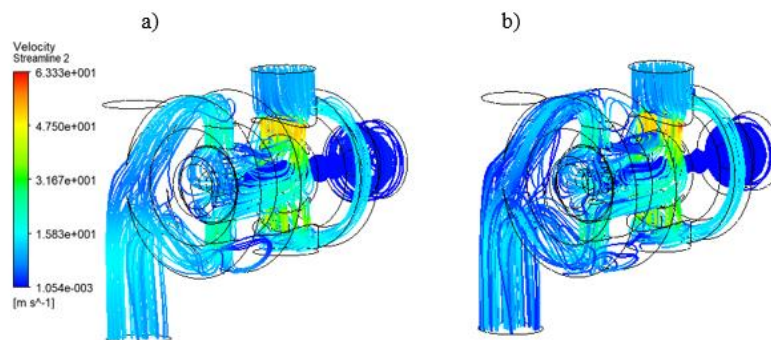
Figure 12 shows shear stresses on the walls of the spool. An asymmetrical distribution of shear stresses causes rotation and determines the direction of rotation.



**Fig.12.** Vectors of shear stress on the spool surface.

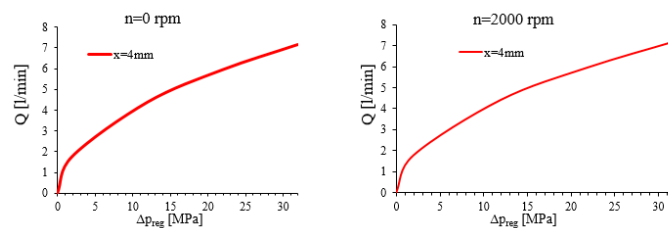


Figure 13 presents the results of the CFD analysis shown as streamlines, for parameters: throttle valve setting  $\alpha=0^0$ ,  $p_1=32$  MPa,  $p_2=30$  MPa, rotation speed of the spool  $n=2000$  rpm and  $n=0$  rpm. As it is shown rotation does not have significant influence on the flow rate. However, the streamlines and velocity in both cases are very similar.



**Fig.13.** Results of the CFD analysis – streamlines: a) for  $n=2000$  rpm, b) for  $n=0$  rpm .

Figure 14 shows a comparison between results obtained while the spool is rotating and when it is stationary.



**Fig.14.** Characteristics of flow rate in function of pressure drop on flow control valve.

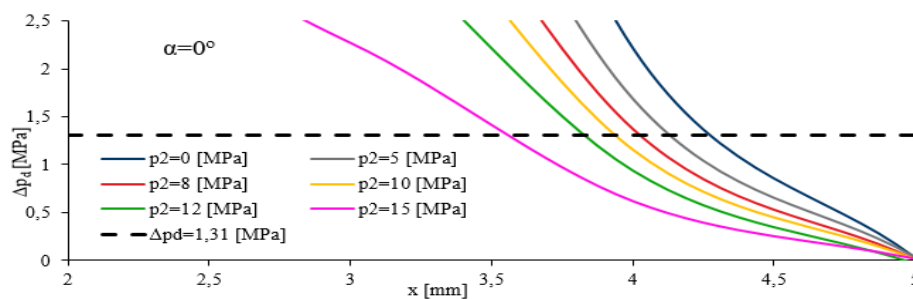
As it is mentioned above the rotation speed was intentionally set to 2000 rpm, which is very high or even impossible. Since such high rotation speed had negligibly small impact on the flowrate, smaller rotation speeds would not have significant influence, either. Therefore to simplify further simulations the spool was considered as stationary.

#### 4 The methodology of determining flow characteristics of the prototype from CFD simulations

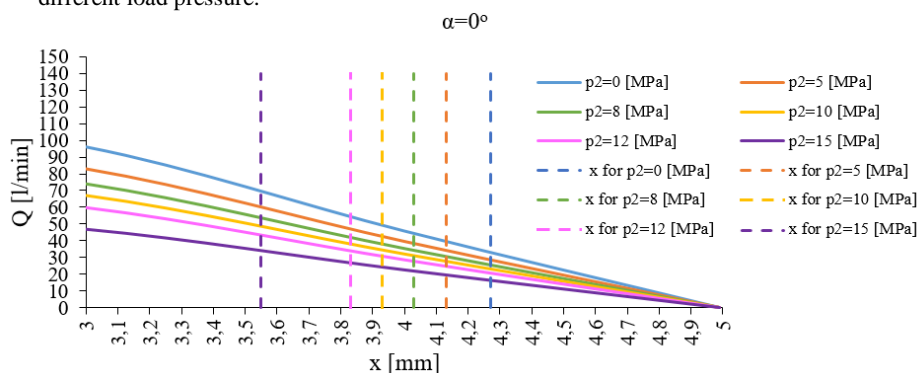
For the purpose of determining flow characteristics, it is necessary to know parameters, which define the operation of the prototype. As the position of the spool  $x$  during tests is unknown and it is changing depending on load pressure  $p_2$  and

adjustment of the throttle valve  $\alpha$ , many simulations were conducted for these parameters.

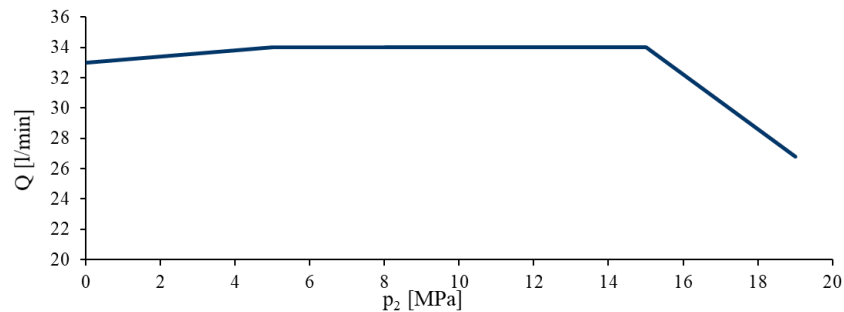
The methodology of determining flow characteristics is based on several steps. Firstly, constant inlet pressure  $p_1=20$  MPa was applied. Diameter of surface  $A_1$  (Fig.4) is equal 11.6 mm and diameter of surface  $A_2$  is equal 12 mm [5]. By using equation (2) it was calculated that pressure drop on throttle valve  $\Delta p_d$  should equal 1.31 MPa. CFD simulations were conducted for different load pressures  $p_2$  and different displacements of the spool  $x$ . Secondly, characteristics of pressure drop on throttle valve  $\Delta p_d$ , at different displacements and load pressure settings were determined. Calculated value  $\Delta p_d = 1.31$  MPa was marked as a black, broken, horizontal line in that chart (Fig.15). Cross points given by this line and characteristics, are the position of the spool for different load pressures  $p_2$ , at which  $\Delta p_d$  equals 1.31 MPa. These positions were marked as dashed, vertical lines on characteristics of flow rate for different positions of the spool  $x$  and load pressures  $p_2$  in Fig.16. Basing on these positions, cross points with flow rate  $Q$  characteristics for different load pressures  $p_2$  were read from Fig.16. Obtained points were used to create characteristic of the prototype flow control valve, which is shown in Fig.17.



**Fig.15.** Characteristics of drop pressure at throttle valve in function of position of the spool for different load pressure.



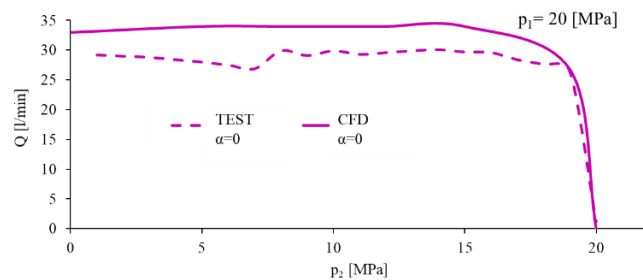
**Fig.16.** Characteristics of flow rate in function of position of the spool for different load pressures.



**Fig.17.** Characteristic of the prototype flow control valve.

## 5 Conclusion

In the article experimental and computational method was used to determine the behavior of the prototype flow control valve. CFD simulations were conducted for 610 configurations and results were used to determine the flow characteristic of the prototype flow control valve. For example, Fig. 18 presents comparison between results of laboratory test and CFD simulations for throttle valve setting  $\alpha=0^0$ .



**Fig.18.** Comparison between results from laboratory test and CFD simulation [8]

Both methods have given valuable results. However, separately they did not give the full information about valve operation, but together they proved to be complementary. Thanks to the experimental data the computational model was improved and then validated. Results of laboratory tests and CFD simulations have satisfactory convergence, what is shown in Fig. 18. It is assumed that the convergence can be further improved by including hydrodynamic forces in CFD model. The main problem, that is so far unresolved is the fact that the results of computational simulations do not show characteristic flow rate drop (Fig. 8) which occurs during laboratory tests. Since CFD simulations did not show relation between flow phenomena and flow rate drop, it is very probable that phenomenon is related with friction or hydrodynamic forces, which were not included in CFD analysis.

The methodology of determining characteristics of the flow control valve from simulation proved to be accurate. It has also given very valuable information about spool position during the operation of the valve, which so far has not been reliably measured.

The future work will concentrate on improving the CFD model and on building new test stand, which will allow to obtain more information about the prototype, which hopefully will help to develop new design free of the malfunctions described earlier.

## References

1. Osiecki A.: „Hydrostatyczny napęd maszyn”, WNT Warszawa (1998).
2. Vademecum hydrauliki: „Hydraulika. Podstawy, elementy konstrukcyjne i podzespoły. Tom I”, Bosch Rexroth (2007).
3. Stryczek S.: „Napęd Hydrostatyczny. Tom I. Elementy”, WNT Warszawa (2005).
4. Datasheet Flow control valves cartridge 2-way typ UDRN6, Ponar Wadowice, (2000).
5. Śliwiński P.: Regulator przepływu// W : Badanie, konstrukcja, wytwarzanie i eksploatacja układów hydraulicznych/ ed. Prof. dr hab. inż. Adam Klich, Dr inż. Antoni Kozieł ul. Pszczyńska 37, 44-101 Gliwice,: Instytut Techniki Górniczej KOMAG, 2015, s.82-93.
6. Śliwiński P.: Regulator przepływu, Polish patent PL 224522 B1.
7. Lipski A.: Badania laboratoryjne regulatora przepływu. Praca dyplomowa magisterska. Promotor: dr inż. Paweł Śliwiński. Politechnika Gdańska (2013).
8. Ellwart T.: Badania eksperymentalne regulatora przepływu. Praca dyplomowa inżynierska. Promotor: dr inż. Paweł Śliwiński. Politechnika Gdańska (2014).
9. Domagała M., Momeni H., Fabis-Domagała J., Krawczyk M., Filo G., Bikass S., Numerical Simulation of Fluid Flow Inside The Flow Control Valve, Quality Production Improvement, volume 1, issue 1, pp. 394-399 (2019).
10. Suzuki K., Urata E., Development Of A Water Hydraulic Pressure-Compensated Flow Control Valve, International Journal of Fluid Power 9, No. 3 pp. 25-33 (2008).
11. Lisowski E., Czyżycki W., Rajda J., Three dimensional CFD analysis and experimental test of flow force acting on the spool of solenoid operated directional control valve, Energy Conversion and Management 70, pp. 220-229 (2013).
12. Lisowski E., Rajda J., CFD Analysis Of Flow Forces Acting On The Spool Of Directional Control Valve Type WE10J, Technical Transactions Mechanics, 2-M, (2015).
13. Menter F.R: Two-Equation Eddy-Viscosity Turbulence Models for Engineering Applications, American Institute of Aeronautics and Astronautics Journal, 32(8), 1598-1605 (1994).
14. Menter F.R, Kunts M., Langtry R.: Ten Years of Industrial Experience with the SST Turbulence Model, Turbulence, Heat and Mass Transfer 4, (2003)
15. Technical Brief Innovative Turbulence Modeling: SST Model in ANSYS CFX,11(4),(2004).