

# Proposition for Simplified Calculation of a Roll Motion of Ship in Waves with Partially Flooded Compartments

Piotr S. Szulczewski

This paper contains a description of a numerical model for calculating behaviour of ships in waves. There are many models available, but the one described here can be characterised with a set of parameters that have a decisive impact on the final values of roll motion amplitude and frequency. In this paper, it is shown how a fitting of a standard-shape hull characterised by certain readily available parameters affects the final roll and frequency of the motion. In addition, calculations for a flooded tank were made, and a range of results for the maximum dynamic heeling forces from this tank is shown. This calculation can further be verified for a range of hull dimensions and geometries to present a viable method to the industry.

## KEY WORDS

- ~ Seakeeping
- ~ Modelling
- ~ Roll motion
- ~ Ship in waves
- ~ Partial flooding

KASI Centre for Maritime Simulation, Malaysia

e-mail: [peter.szulczewski@kasimalaysia.com](mailto:peter.szulczewski@kasimalaysia.com)

doi: 10.7225/toms.v10.n01.004

This work is licensed under 

Received on: Sep 1, 2020 / Revised on: Feb 1, 2021 / Accepted on: Feb 1, 2021 /  
Published: Apr 20, 2021

## 1. INTRODUCTION

In this paper, an attempt is made and described to present the equations of the motion of a ship in waves, in the function of a set of parameters. For the purpose of this presentation of the method, the analytical model was chosen for calculations of the behaviour of hulls and the 'strip-theory' was applied (Salehi, 2014; Ursel, 1949).

An additional problem related to solving the dynamic equations of motion is related to solving the impact from partially filled tanks on the behaviour of the vessel and vice versa. The main problems related to solving equations of motion and fitting engineering formulas to these differential equations is related to identification of the exact parameters that have decisive impact on the final parameters of motion.

Before calculations of dynamic forces for ship tanks (sloshing) took place, investigation was made whether the flooded tank's natural frequency and the ship motion overlap in such a way as to constitute a risk of oscillations (Fan, Xia). As result of these calculations, it was found that the risk of oscillations appeared only during the flooding and not in the final stage of it. The risk of oscillations between the movement of water flooding the tank and the roll motion of the ship may present a hazard to the vessel. However, since the risk of oscillations most often happens during flooding (not when the tank is flooded to the waterline level) and considering the fact that in an emergency flooding is likely to take place rapidly, although the risk must be noted, it was not further investigated.

Furthermore, there is a presentation of a model for evaluating behaviour of a vessel in waves by fitting a standard

hull shape with certain fixed geometrical and mass decisive properties presented below. At the same time, an evaluation of a dynamic impact from water inside the tanks is also included. For both models, a set of assumptions had to be made and is presented below.

## 2. ASSUMPTIONS

In order to model the behavior of a ship in waves, a set of assumptions was made applicable:

- The pressure under the wave crest is modelled with the use of hydrostatics.
- The calculation is valid for ships with large L to B and L to H ratios (more than 4) and the ships must be symmetrical around the x-axis (because of the damping coefficients formulas included in the ITTC method limitations).
- The flooding of the tank investigated takes place quickly.
- Motion amplitude is small so that equations can be linearized (Faltinsen, 1970; 1990). This means that damping coefficients and added mass coefficients are constant in time/frequency and that motions of a ship can be calculated separately with minimum error to the results introduced (quasi-dynamical approach). (This assumption will cause an error in calculations, but as evaluated in multiple studies, e.g. Salvesen 'Ship Motions and Sea Loads (p. 262, Figure 7), a good correlation was determined up to 7.5-degree roll angles, the final values are not very far off the actual values and may be considered a good approximation).
- The motions that have a decisive impact on survivability of a ship in waves are the motions that impact the vertical position of weather-tight openings or deck lowest point in the weather conditions. These are roll, sway (to determine the reaction of a vessel to perpendicular wave), pitch and heave. Consequently, the stability of a ship can be accurately described by determination of the damping and added mass coefficients <for the following motions: roll, sway, heave and pitch only.
- The waves are non-directional and of single periodicity. (This is not the case at sea; however, for the purpose of finding parameters of submerged parts of hull, the directional nature of waves was neglected).

### 2.1. Coordinate System

The right-handed system of coordinates (Faltinsen, 1970; 1990) is fixed, with the center of gravity of the ship and its origin set at a waterline level. Axis Z goes through the center of gravity. Though selection of this model introduces some complexity to the mathematical model, it allows for a good presentation of results.

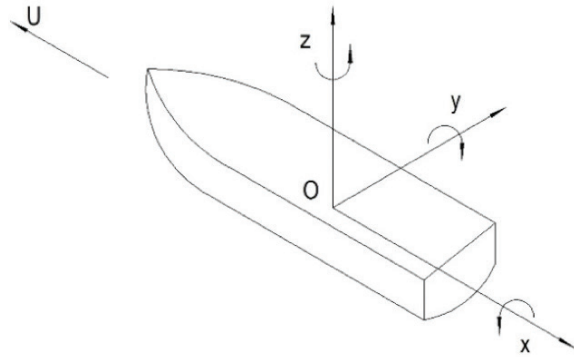

Figure 1. Selected coordinate system.

### 2.2. Static Components in Motion Equation

It is a commonly used method to split motions into two categories, which are treated differently. The first category contains the heave and pitch, and the second one contains yaw, roll and sway motions (Salvesen, 1970). For the former two motions, the method linearizes motions with respect to the wave amplitude. The roll motion component shows a significantly non-linear behaviour with respect to the wave amplitude. The obvious reasons for this behaviour are large amplitudes of this motion on the one hand and quickly changeable parameters governing this motion, on the other. With this in mind, separate assumptions for calculations for the two groups were used, and the results were added to each other after recalculation to time domain and with the use of superposition principle. All the motions are computed in frequency domain. The roll motion is calculated at shorter steps to account for the larger amplitudes of motion.

The general equation governing 6 degrees of freedom in ship's motion can be presented as below and further simplified and divided into the static and dynamic components (1) (Faltinsen, 1970; 1990; Schmitke, 1987; Trawintafyllou, 1983).

$$\sum_{k=1}^6 [(M_{jk} + A_{jk}) \ddot{\eta}_k + B_{jk} \dot{\eta}_k + C_{jk} \eta_k] = F_j e^{i\omega t} + F_E \text{ simplified to}$$

$$\begin{bmatrix} M & 0 \\ 0 & I_y \end{bmatrix} + \begin{bmatrix} A_{33} & A_{35} \\ A_{53} & A_{55} \end{bmatrix} \ddot{\eta}_u + \begin{bmatrix} B_{33} & B_{35} \\ B_{53} & B_{55} \end{bmatrix} \dot{\eta}_u + \begin{bmatrix} C_{33} & C_{35} \\ C_{53} & C_{55} \end{bmatrix} \eta_u = \begin{bmatrix} F_3 \\ F_5 \end{bmatrix} e^{i\omega t}$$

and (1)

$$\begin{bmatrix} M & 0 & -Mz_c \\ 0 & I_x & -I_{xz} \\ -Mz_c & -I_{xz} & -I_z \end{bmatrix} + \begin{bmatrix} A_{22} & A_{24} & A_{26} \\ A_{42} & A_{44} & A_{46} \\ A_{62} & A_{64} & A_{66} \end{bmatrix} \ddot{\eta}_v +$$

$$\begin{bmatrix} B_{22} & B_{24} & B_{26} \\ B_{42} & B_{44} & B_{46} \\ B_{62} & B_{64} & B_{66} \end{bmatrix} \dot{\eta}_v + \begin{bmatrix} C_{22} & C_{24} & C_{26} \\ C_{42} & C_{44} & C_{46} \\ C_{62} & C_{64} & C_{66} \end{bmatrix} \eta_v =$$

$$\begin{bmatrix} F_2 \\ F_4 \\ F_6 \end{bmatrix} e^{i\omega t} + \begin{bmatrix} F_E \\ M_E/Z \\ M_E/X \end{bmatrix} e^{i\omega t}$$

The dynamic components are represented by  $M_{jk}$ ,  $A_{jk}$  and  $B_{jk}$ . The static components of ship's motion are described by  $C_{jk}$ . In the equation for heave, pitch, and yaw motions, the static coefficients are determined by the following equation (2, 3, 4). (Static components of a simplified ship's motion equation for heave and pitch (Schmitke, 1987; Traintafyllou, 1983):

$$C_{33} = \rho \cdot g \cdot \int b \, dl_s = \rho \cdot g \cdot A_{WP} \quad (2)$$

$$C_{33} = C_{35} = -\rho \cdot g \cdot \int b \cdot l_s \, dl_s = -\rho \cdot g \cdot (z_{LM} - z_G) \cdot A_{WP} \quad (3)$$

$$C_{55} = \rho \cdot g \cdot \int b \cdot l_s^2 \, dl_s = \rho \cdot g \cdot I_{WPY} \quad (4)$$

The static components of a simplified ship's motion equation for roll and sway (Faltinsen, 1970; 1990):

$$C_{44} = \rho \cdot g \cdot \nabla \cdot (z_M - z_G) \quad (5)$$

$$C_{22} = C_{24} = C_{42} = C_{26} = C_{46} = C_{66} = C_{64} = C_{63} = 0 \quad (6)$$

The static component of the restoring force for heave ( $C_{33}$ ) is called Restoring Spring Coefficient, and in the given environment it depends solely on the area at the waterline of the submerged hull ("image" of the submerged hull on an imaginary horizontal plane).

The static components of the restoring forces for pitch and the coupled motions of pitch and heave are called stiffness coefficients and are functions of longitudinal metacentric height, water plane area and moment of inertia of the water plane area around the y axis. There are no restoring forces for the sway and yaw motions and hence, the remaining coefficients  $C_{xx}$  are equal to zero.

### 2.3. Dynamic Components in Motion EquatiON

Derivation of dynamic components is a difficult task, and numerous attempts have been made so far to increase the accuracy of the coefficients obtained.

However, the common practice remains to validate analytical/numerical simulations with tests in the ship model basin. For the purpose of this method, a derivation technique has been utilized with great focus on eliminating the risk of overestimating these coefficients and limiting the complication of the calculations.

Coefficients  $M_{jk}$ ,  $A_{jk}$  and  $B_{jk}$  from equation (1) depend on the time and position of the vessel in relation to the sea surface.  $M_{jkt}$  is called the generalized mass matrix of a ship. The  $M$  value is the mass of the ship, and it remains constant when afloat. Given the selected coordinate system at the waterline, the value of  $z_c$  is the value of the vertical position of the center of the ship's mass against the origin of the coordinate system. The  $I_y$ ,  $I_x$ ,  $I_z$ ,  $I_{xz}$  are the values of moment of inertia around the respective axis, as presented in Figure 1 above.

The  $A_{jk}$  is called added mass coefficients matrix and directly reflects the dynamic force acting on the structure that is caused by the pressure field of the fluid being forced to oscillate by the moving structure. The added mass in the four motions taken into account is governed by the shape of the submerged body, frequency of motion and, naturally, the size of the submerged body. It is not an easy task to accurately predict the values of added mass coefficients; however, alternative methods, such as the close-fit Frank method, which were proven to provide good accuracy (Schmitke, 1987; Journee, 2001; Wang, 2012; Das, 2006; Hem Lata, 2007), may be used. For example, for derivation of necessary coefficients, a hydrodynamic model may be applied to a range of "mid-ship sections" as well as mass parameters and then transferred into a three dimensional model with the use of strip theory.

The common difficulty in utilizing the close-fit method for calculations of dynamic components is ensuring good correlation for various transverse section shapes. Instead of the usual application of Ursell-Tasai's (Salehi, 2014) method with 10-parameter close-fit conformal mapping, which is very time consuming, it is proposed to use the statistical correlation

between the results for various hull geometries and estimate the results for individual shapes on the basis of the length of the cylindrical section and/or block coefficient (at scantling draft) value. (Note: In addition, due to the symmetry around the X-axis of ship's underwater geometry, the transverse and longitudinal motions are decoupled.) For practical calculations, a standard recommended by ITTC method of estimation of roll damping was utilized (ITTC, 2011) and further evaluated with the method described by Kawahara, Maekawa and Ikeda (2012). Components for movements in other directions come from the generally known formulas (Faltinsen, 1970; 1990, Schmitke, 1978). The roll movement is more sensitive to the forces that cause it and hence was divided into components presented in equation 12 in order to model it accurately.

The  $B_{44w}$  is a coefficient described as wave-making coefficient. The wave component for a two dimensional cross section is calculated by potential flow theory. A calculation of the damping coefficient in sway motion for a given hull form is needed. Since the longitudinal section of a ship can be quite accurately and relatively easily approximated by analytical formulas, calculation of the wave-making component at zero speed may then be performed by multiplication of this coefficient with the roll lever (7) (ITTC, 2011).

$$B'_{44w0} = B'_{22} \cdot (I_w - \overline{OG})^2 \quad (7)$$

The ITTC also provides a recalculation method for the wave-making component at different speeds. It is important to underline that for big ocean-going cargo ships this component of damping is relatively small in comparison with other components.

The  $B_{44L}$  is a lift-making component and must be added to ships moving forward with a sway motion. It is described mainly by speed, size of the vessel and the position of the centre of gravity of the ship (8) (ITTC, 2011).

$$B_{44L} = \frac{\rho}{2} VLdk_N I_0 I_R \left( 1 - 1.4 \frac{\overline{OG}}{I_R} + \frac{0.7 \overline{OG}}{I_0 I_R} v \right) \quad (8)$$

The  $B_{44f}$  is a frictional component and at zero speed it can be derived from the well-known Kato's formula. The Kato's formula describes this coefficient among others as a function of area, viscosity, and surface friction. ITTC proposes another calculation formula for ships moving forward at constant speed (9) (ITTC, 2011).

$$B'_{44f0} = \frac{4}{3\pi} \rho S_f R^3 \varphi_a \omega_E C_f \quad (9)$$

The  $B_{44E}$  is an eddy-making component (10) (ITTC, 2011) and it comes from the sectional vortices. Its relation to the hull shape was described by half breadth to draught ratio and area coefficients. These have also been used in this paper and are considered industry standard. This coefficient is further recalculated if the vessel is moving at a given speed.

$$B'_{44f0} = \frac{4\rho d^4 \omega_E \varphi_a}{3\pi} C_R \quad (10)$$

The  $B_{44APP}$  is additional resistance coming from appendages such as bilge keels and rudders. All external hull appendages have some impact on the behaviour of a ship. In the method proposed in this paper for identification of physical parameters that have a decisive impact on roll motion, only the bilge keels are considered. The reason for selecting the bilge keels is that their area is usually the greatest and they are specifically designed for the purpose of reducing ship's roll movement. Their impact must be therefore taken into account. The methodology for calculation of the effect from bilge keels is taken directly from the recommended components by ITTC guidelines. The  $B_{44APP}$  coefficient (with respect to bilge keels) can be divided into four components (11) (ITTC, 2011).

$$B_{44APP(BK)} = B_{44KNO} + B_{44BKL} + B_{44BKW} \quad (11)$$

It has been found that the components  $B_{44BKL}$  and  $B_{44BKW}$  have a marginal impact on the final value of the sum from equation (11). In the practical range of the parameters listed above, the impact from  $B_{44BKW}$  representing the wave-making impact is negligible for two reasons. Firstly, the criterion for acceptance of vessel's response in waves is based on the condition of submerging of freeboard. When applying a two dimensional strip method and at fully laden draught, it is clear that for a practical range of vessels submerging of freeboard will appear well in advance of the emerging of bilge keels from water. Furthermore, this component remains small in relation to the  $B_{44BKN0}$  and  $B_{44BKHO}$  even if the bilge keels emerge from water. In all cases investigated

for the purpose of this work this component remained below 1 % of any of the  $B_{44BKNO}$  and  $B_{44BKHO}$  components. Secondly, the lift-making component  $B_{44BKL}$  is only applicable when the vessel is moving forward. However, as stated in the guidelines from ITTC (2011), the effect of this component is often omitted and starts to play a major role for vessels moving forward at high speeds. In the current economic environment, these high speeds are very unlikely to be attained by cargo carrying vessels. Therefore, this component was neglected. Calculation of the damping coefficient for each two-dimensional strip does not take place in time domain; it is solely dependent on the input parameters from the calculations without these appendages. In other words, the output movement parameters of an investigated shape without bilge keels are treated as input parameters for the equations for calculation of the damping effect from these appendages.

The  $B_x$  component of equation 12 is an additional component that is not included in the original ITTC recommended procedure and represents a change in damping parameters arising from flooding of a compartment. This effect was studied in the past (Miller, 1974; Krata, 2013; Fujiwara, 2009). It was found that, although it cannot be easily quantified as it is a result of fluid changing the behaviour of the entire object and vice versa, the moment from sloshing on final motion increases almost linearly with an increase in the amplitude of motion and hence, the impact on the total roll-damping coefficient (percentage-wise) decreases with roll angle and remains relatively small for large roll amplitudes above 5 degrees.

$$B_{44} = B_{44W} + B_{44L} + B_{44F} + B_{44E} + B_{44APP} \quad (+ B_x) \quad (12)$$

In addition to the damping coefficients, the added mass in the roll motion ( $A_{44}$ ) may be approximated by a function of investigated section area, draught, and distance between the centre of buoyancy and gravity of the moving hull (13) (Salvesen, 1970; Faltinsen, 1970; 1990).

$$A_{44} = \rho A \left( \frac{d^3}{12} + dBG^2 \right) \quad (13)$$

In case of a damaged ship, additional mass of water that enters the hull must be considered. This leads to a change of the differential movement equation (14) in such a way that an additional mass is added to the mass of the object. Furthermore, the static coefficient  $C_{44}$  must also be amended to reflect the new initial condition of a vessel.

## 2.4. Excitation forces

It was found that the change of the initial condition of the vessel after e.g. tank flooding may be represented by an excitation force added on the right side of the equation (14).

$$F_s = (-Mx - Ax) \ddot{\Phi} - B_x \dot{\Phi} - C_x \Phi \quad (14)$$

where:

$$\Phi = Ae^{i\omega t}$$

$$\dot{\Phi} = i\omega Ae^{i\omega t}$$

$$\ddot{\Phi} = -A\omega^2 e^{i\omega t}$$

$$F_s = A_F e^{i(\omega t + \varphi)}$$

$$\begin{aligned} -(M_x + A_x) &= \operatorname{Re} \left( \frac{A_F e^{i(\omega t + \varphi)} - C_x A e^{i\omega t}}{\omega^2 A e^{i\omega t}} \right) \\ &= \operatorname{Re} \left( \frac{A_F e^{i\varphi} - C_x A}{\omega^2 2A} \right) = \frac{A_F \cos(\varphi)}{\omega^2 A} - \frac{C_x}{\omega^2} \end{aligned}$$

$$\begin{aligned} B_x &= \operatorname{Im} \left( \frac{A_F e^{i(\omega t + \varphi)} - C_x A e^{i\omega t}}{\omega A e^{i\omega t}} \right) \\ &= \operatorname{Im} \left( \frac{A_F e^{i\varphi} - C_x A}{\omega 2A} \right) = \frac{A_F \sin(\varphi)}{\omega A} - \frac{C_x}{\omega} \end{aligned}$$

where:

$A_F$  - Force amplitude

$A$  - Wave amplitude

$\omega$  - Wave frequency

$t$  - Time

$\varphi$  - Phase angle (lag)

$C_x = I^x \cdot \rho^x \cdot g$

The other excitation forces modelled are the forces from waves. The well-known common practice is to measure the significant wave height. The significant wave height ( $H_{1/3}$ ) is by definition "the mean wave height (trough to crest) of the highest third of the waves" (Ainsworth, 2005) and is measured by an experienced crewmember with the naked eye. The crew on board may relatively easily observe the height of the waves, but not their period. When evaluating ocean waves' statistics to determine the risks for ocean going ships in the form of a harmonized method, the range of wave periods must be evaluated.

To achieve this, the statistical correlation between significant wave heights and wave periods was brought into a two dimensional shape (Figure 2).

The probability values of wave height may have a very different impact on the safety of ships, depending on the shape of waves and their period. Therefore, selecting just one

most probable wave period is considered a very inaccurate approximation. For the purpose of this paper, the range of all the wave periods for waves of significant height up to 4 meters (whose probability is estimated at more than 0.91) was investigated.

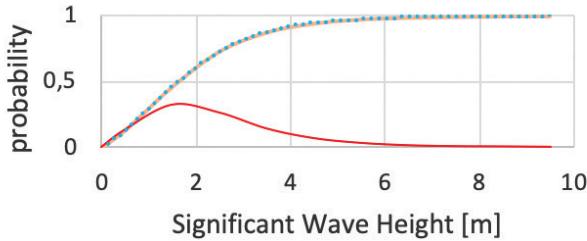

**Figure 2.** Example probability density function (grey colour) of the significant wave height based on statistical data for World Wide Trade. (Vassalos, 2007).

The forces from waves in the frequency domain calculation model were divided into Froude-Kriloff forces and moments and diffraction forces, and in strip theory they may be presented as integrals for each investigated strip (15, 16).

$$\begin{bmatrix} F_2 \\ F_4 \\ F_6 \end{bmatrix} = \begin{bmatrix} \int f_{2FK} x + f_{2D}(x) dx \\ \int f_{4FK} x + f_{4D}(x) dx \\ \int (x \cdot (f_{2FK}(x) + f_{2D}(x)) - U \cdot a_{22}(x_{mean}) v) dx \end{bmatrix} + \begin{bmatrix} U \cdot a_{22}(x_{mean}) w \\ U \cdot a_{42}(x_{mean}) v \\ U \cdot a_{22}(x_{mean}) v \end{bmatrix} \quad (15)$$

$$\begin{bmatrix} F_3 \\ F_5 \end{bmatrix} = \begin{bmatrix} \int f_{3FK} x + f_{3D}(x) dx \\ \int (x \cdot (f_{3FK}(x) + f_{3D}(x)) - U \cdot a_{33}(x_{mean}) w) dx \end{bmatrix} + \begin{bmatrix} -U \cdot a_{22}(x_{mean}) w \\ U \cdot x_{mean} \cdot a_{33}(x_{mean}) w \end{bmatrix} \quad (16)$$

where:

$$\begin{aligned} f_{2FK}(x) &= ipg\zeta_a \int n_3 e^{-ik(x\cos\beta + y\sin\beta)} e^{kz} dl \\ f_{3FK}(x) &= ipg\zeta_a \int n_2 e^{-ik(x\cos\beta + y\sin\beta)} e^{kz} dl \\ f_{4FK}(x) &= ipg\zeta_a \int n_4 e^{-ik(x\cos\beta + y\sin\beta)} e^{kz} dl \end{aligned}$$

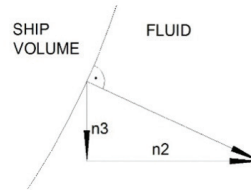

$$\begin{aligned} n_4 &= yn_2 - zn_3 \\ f_{2D} &= a_{22}(x)a_y + b_{22}(x)v \\ f_{3D} &= a_{33}(x)a_y + b_{33}(x)w \\ f_{4D} &= a_{42}(x)a_y + b_{42}(x)v \\ a_y, a_z, v, w & \text{ - initial accelerations and speeds} \\ & \text{ approximated as per Salvesen (1970, pp.77,78)} \end{aligned}$$

The accuracy of the model used (15, 16) depends on e.g. the panellization of the cross sections. If the panellization is accurate enough, the vertical and horizontal components of vector 'n' will be accurate; if, however, the panellization is not accurate or does not follow the geometry that may change rapidly at e.g. knuckles, the error may be large and difficult to control.

Another component that should be taken into account is the wind component. Up to date, it is common for the statistical correlation between wave height and wind to be taken for derivation of the wind speed. Confidence in this correlation may be greatly improved if the observation-derived parameters of wind speed required for generation of waves of certain height are taken into account. Such parameters for ocean weather conditions may be derived from available literature (Fujiwara, 2009; Hardin, 2013; Bowditch, 1995).

The investigation revealed that calculation of impact from any tank subject to flooding provides information on the vessel's restoring forces ability in countering this effect. The investigation revealed that this impact can be further broken down into the following components:

- Should the size (e.g. length) of a tank be large, the water in tank will have a noticeable impact on initial stability and the weight of water in the tank will have an impact on initial floating condition and centre of gravity.
- The sloshing occurring in the tank will add to the overall number of heeling moments acting on the ship.
- The shift of the centre of gravity in the tank will change the righting ability of the vessel (free surface effect).
- Other phenomena (such as air cushions) may be considered rare and at this stage were omitted.

In case of practical application, the initial condition of the vessel after flooding of a tank may also be easily investigated



and determined with the use of popular hydrostatic software or currently existing loading computer software installed on board ships. Once the initial condition is known and the ship behaviour is numerically calculated, the values of sloshing may be added to the right side of the movement equation (excitation forces) or, in static terms, as additional heeling moment. In most cases, this will provide the most conservative result as only the constant static righting ability is considered. This may be done by application of the largest possible excitation force to the equation, assuming that the direction of this force is always the same as that of the exciting force from the waves (the worst possible scenario in terms of roll amplitude). This relationship becomes more complex when the impact on the behaviour of the ship from sloshing in the tank is greater.

To accurately and efficiently calculate the discussed coupling effects between the motion of a ship and the fluid in a tank, the transformation can be divided into two stages:

1) Handling mass in the tank.

The impact of water in the tank may be divided into dynamic and static parts. The dynamic part (sloshing) was found to have an independent effect from the static part (the mass). The dynamic forces from sloshing are related to the change of the surface of the fluid and not its entire volume. Namely, the value of the dynamic force does not depend on whether the tank is filled in a wide range of filling levels (e.g. 10 % or 50 %).

The equation of motion with the mass of the fluid in tank “x” can be presented as below (17):

$$(M + A + M_x) \ddot{\phi} + B\dot{\phi} + C\phi = F_{ext} \quad (17)$$

In this case, only the static impact from the additional mass is taken into account.

2) Added Mass and Damping

In order to address this impact and reintroduce it as a complex force acting on the movement of the ship, a force is added to the model on the right side of the equation (18).

$$F_S = F_{dynamic} - M_x \ddot{\phi} \quad (18)$$

The presence of additional mass inside the vessel further influences the added mass and damping properties of the entire floating object. In order to simplify these calculations, the model presented in equation (18) was brought to a static form.

### 3. DETAILED INFORMATION ON THE PRESENTED CALCULATION METHOD

#### 3.1. Identification of Parameters Responsible for Behaviour of Intact Ship on Waves

It was found that for cargo ships of wide range of geometrical and mass parameters the response of the object may be accurately estimated with approximation formulas described above. However, the excitation formulas must be calculated directly in the potential (or time) domain. If the strip method is applied, generation of a set of geometries is required that will be subjected to investigated excitation forces. A programme was written in Matlab that allows for fitting the basic geometrical parameters to a complex set of geometries with a very limited number of assumptions (ITTC, 2011; Kawahara et al., 2012).

The response of the hull to excitation forces (roll movement) can be presented as a function of several basic ship parameters (Table 1). From the author’s experience in calculating dynamic motions of different ships, an idea arose to generate a series of hulls that would closely fit the parameters of most standard cargo ships. For this paper, the programme for hull generation is based on Taylor Hull series 60 with some minor modifications to the original shapes from this series (Bole, 2006; Tunaley, 2013). These modifications took place to more fully describe the geometries and consider more modern geometries, e.g. with bulbous bows forward. In this study, only single-screw ships were considered.

**Table 1.**

List of hydro-mechanical coefficients and factors on which these coefficients depend.

Static and dynamic coefficients	Variables
Friction Damping Coefficient	$C_B, d, B, OG, BG, A, (V, \omega_e, L_{pp} - \text{at speed})$
Wave Damping Coefficient	$C_B, d, B, OG, \omega_e, CM(CB)$
Lift Damping Coefficient	$V, OG, B, d, L$
Eddy-Making Damping Coefficient	$C_B, d, B, OG, \omega_e, L_{pp}, CM(CB), \nabla(L_{pp}, B, d, C_B), \varphi_a$
Bilge Keel (Appendages) Damping Coefficient	$C_B, d, B, OG, A, \omega_e, \varphi_a, l_{bk}, b_{bk}$
Added Mass Coefficient	$A(B, d, CM), d, BG$
Hydrostatical Coefficient	$OG, \nabla(L_{pp}, B, d, CB)$
Excitation forces from flooding coefficient	$L_t, B_t, H_t, OG_t, T_p$

For the purpose of verification, some calculations were made for selected geometries of ships. The geometry included in this paper is that of "Szczecin II" type of vessel (Figure 3).

The mass and geometrical properties of the original and fitted hulls are presented in Table 2. According to all the parameters for the analytical solution of the vessel's motion in roll presented in Table 1, the degree of freedom depends solely on the parameters directly corresponding to the real ship geometry presented in Figure 3 and Table 2. The difference in all these parameters remains small and this suggests that the resulting motion of these two geometries may be similar. For the purpose of verification of the approximation technique, motion calculations with the use of calculated as per the assumptions coefficients were performed and the results of the static and dynamic calculations were compared (Figure 4).

As can be seen from direct comparison of dynamic motion results (Figure 4), the difference between the results from the two investigated geometries is rather small and the maximum amplitude difference (within 100 seconds of motion) is 7.25 % (e.g. 8.663 deg. to 9.341 deg. – Figure 4). As the dynamic components of added mass and damping remain almost the same for the two investigated geometries, the difference may be explained not

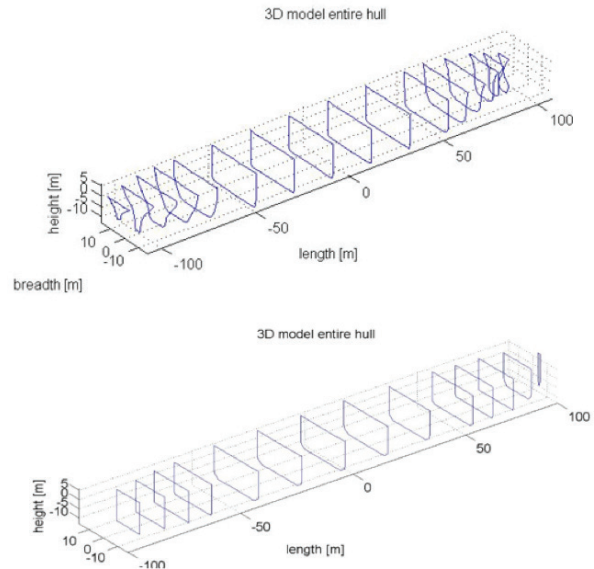

**Figure 3.** Isometric view of the hull of "Szczecin II" type and simplified "Taylor 60" approximated hull.

**Table 2.**

Mass and geometrical properties of the "Szczecin II" hull and its model compared.

SHIP PARTICULARS	REAL GEOMETRY:	MODEL GEOMETRY:	DIF.:
Length between perpendiculars, $L_{pp}$	205	[m] 205	[m] 0.00 %
Breadth, B	30.48	[m] 30.48	[m] 0.00 %
Mean draught, d	12.09	[m] 12.09	[m] 0.00 %
Block coefficient, $C_b$	0.81487	[-] 0.814	[-] 0.06 %
Number of frames	16	[-] 20	[-]
HYDROSTATIC:			
Vertical centre of buoyancy, $K_b$	6.3491	[m] 6.167	[m] 2.86 %
Vertical centre of gravity, $K_G$	9.64	[m] 9.64	[m] 0.00 %
Volume displacement, Vol	61,558.1	[m <sup>3</sup> ] 61,523	[m <sup>3</sup> ] 0.06 %
Water plane area, $A_w$	5483.68	[m <sup>2</sup> ] 5.201	[m <sup>2</sup> ] 5.15 %
DYNAMIC PROPERTIES:			
Ship velocity, U	0	[knot] 0	[knot] 0.00 %
Froude number, $F_n$	0	[-] 0	[-] 0.00 %
Wave period, T	7	[s] 7	[s] 0.00 %
Wave height, h	2.2	[m] 2.2	[m] 0.00 %
Heading, Beta	90	[-] 90	[-] 0.00 %
Period of encounter, $T_e$	7	[s] 7	[s] 0.00 %
Frequency of encounter, $w_e$	0.8976	[rad/s] 0.897	[rad/s] 0.00 %



only by the different shape of the investigated geometry, but also by the different position of the centre of buoyancy (2.86 % - in vertical direction), and the slightly different wetted surface area. However, the results remain within the same order of magnitude.

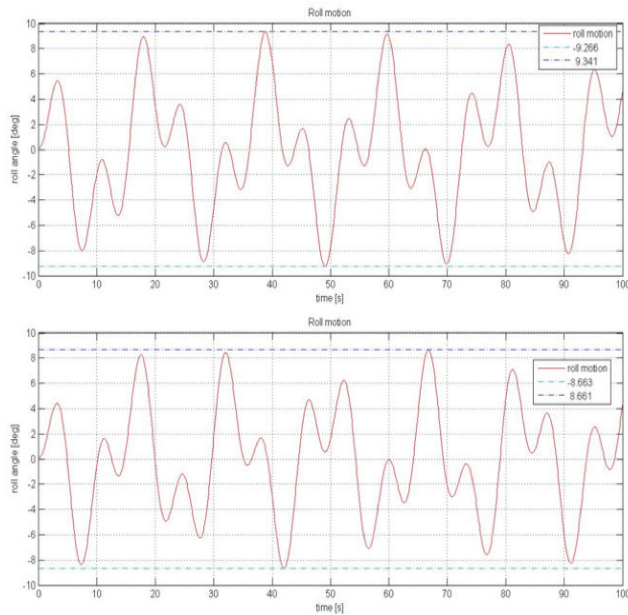

**Figure 4.** Results of calculations performed for "Szczecin II" oil tanker geometry and approximated hull modelled. Regular wave significant height 2.2 m, wave period 7 s.

### 3.2. Identification of Parameters of Partially Filled Tank That Have a Decisive Impact on Dynamic Forces Induced

First, a selection of an investigated shape of the tank is made and simplifications to the geometries are assumed. For the purpose of this paper, some simplifications concerning the geometries and position of tanks against the centreline are proposed (Figure 5).

The proposed algorithm must take into account the dangers arising from coupling the motions and should identify the risks of sloshing as it can have a significant impact on the ship's motion. In this method, the following values were selected for investigation when in regular wave environment:

- Initial conditions
  - a) Initial roll period
  - b) Initial amplitude
  - c) Initial centre of rotation
  - d) Initial damping in roll motion coefficient

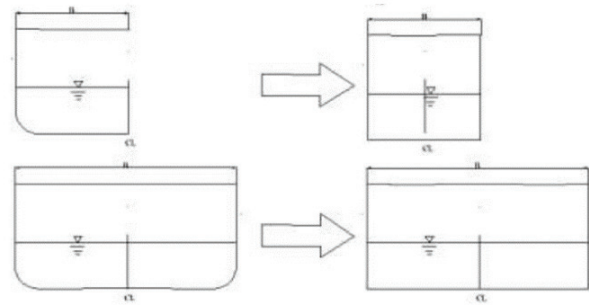

**Figure 5.** Simplification of tank geometries for the purpose of sloshing force calculations.

**Table 3.**

Parameters of flooded tank and movement of decisive impact on ship behaviour.

Variable name	Range investigated
Non-dimensional breadth of tank	0.1 B ~ 1 B
Non-dimensional length of tank	0.01 L ~ 0.2 L
Amplitude of ship motion	2 degrees ~ 30 degrees
Period of roll	5 sec ~ 25 sec
Filling level	10 % - 99 %
Roll motion damping coefficient	1-2.5

- Tank properties
  - a) Length, Breadth, Height and Geometry of the tank
  - b) Filling level in the tank

The position of the tank from the centreline will have a significant impact on the behaviour of water inside the flooded tank due to the increased vertical movement induced by roll and pitch motions. In the analysis presented in this paper, these effects were added as sinusoidal vertical motions. Furthermore, it was found that for the simplest case the impact on the behaviour of fluid inside the tank from the roll motion of the ship is most significant when the assumed motions of the tank have the most conservative parameters (i.e. the shortest periods and maximum amplitudes of motions). These most critical dynamic forces from the tank are calculated by idealizing the motions of the ship to

the sinusoidal motion of the largest calculated amplitude and the shortest time period.

The selected initial parameters of the tank (Figure 5) can be taken for calculations with the following assumptions:

- The tanks of complex geometry can be broken down into simple shapes to allow for selection of a close-fit geometry from a pre-calculated database (Figure 5)
- The position of tank with reference to centerline has an impact only on the asymmetry of flooding and the free surface, but the addition from sloshing is calculated from the roll, sway and heave movements as if the tank were located at the centerline.
- To calculate the sloshing force (FS value) in damaged conditions, the filling level in the tank is always assumed to be the most conservative one with respect to dynamical sloshing.
- Non-vertical limits of tanks (such as bilge radiuses) are modelled as vertical limits because it largely simplifies the calculation with the certainty that the resulting transversal force is not smaller than the actual one.
- Values of calculated sloshing forces for different lengths of tanks can be linearly scaled.
- The damping coefficients applied to simulation of tank movement can be approximated from the ship's motions.
- In the methodology proposed, pressure distribution on the tank's side and bottom is obtained. The forces from the fluid in the tank are estimated by simple integration of pressure on the boundaries of the tank. The predicted ship response is the result of a range of possible impacts from the given tank so that the risk for stability and floatability resulting from flooding of any given investigated tank is calculated.

This approach allows for calculation of a possible impact of flooding of a tank in any investigated ship and under any initial conditions, which is much faster than the direct numerical integration of pressures in time steps (e.g. Kraskowski, 2012) (Figure 8).

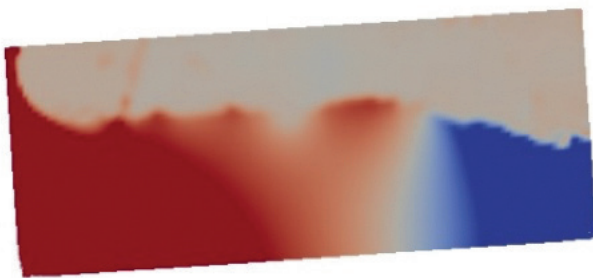

**Figure 6.**  
Selected tank investigated. Red colour shows area of increased pressure, blue colour of decreased pressure.

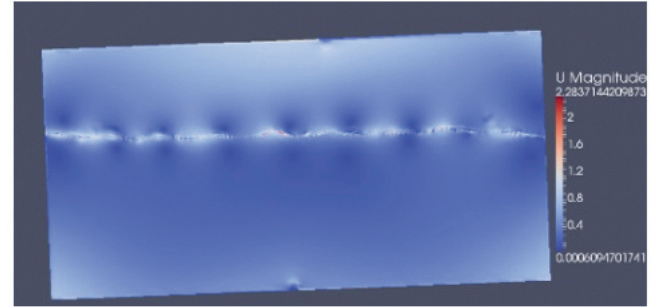

**Figure 7.**  
Selected tank investigated. Red colour shows area of increased higher speed, blue colour of lower speed.

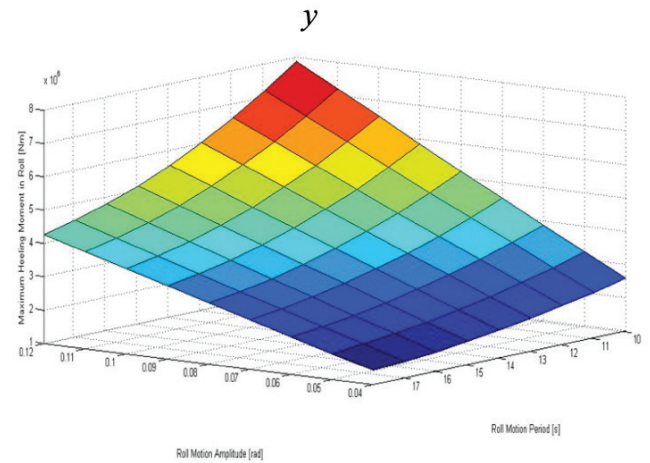

**Figure 8.**  
Calculated maximum registered roll moments from sloshing pressure force in a flooded tank (1m length) in function of roll motion amplitude and roll motion period. (The remaining coefficients as listed in Table 2 were fixed for the purpose of this visualization.)

To avoid the coupling of the two almost sinusoidal motions, for any given tank a separate investigation of the relationship between natural roll frequency of the tank and ship roll frequency in waves should be made. In this model it was achieved with the help of the well-known design formula (19) (Journee, 2001; Krata, 2013):

$$\forall 2 \cdot n \in N \omega_{0-TANK} = \sqrt{\frac{\pi \cdot g}{b} \cdot \tanh\left(\frac{\pi \cdot h}{b}\right)} \neq \omega_{roll-SHIP} \quad (19)$$

## 4. CONCLUSIONS

In this paper, a model which individually takes into account different mechanisms governing the roll motion of a ship in waves was introduced. The analytical model presented here has its roots in W.E. Cummins work and is used as a possible way of obtaining the necessary parameters.

With the use of the strip model for the behaviour of a vessel in waves, it is shown that it should be possible to derive a set of parameters that have a decisive impact on the final value of the amplitude and the period of the ship's roll motion. The calculations for a fitted hull geometry with the use of standard hull series gave results similar to that of the original hull. In addition, it is shown that a derivation of parameters that have a decisive impact on the results from sloshing forces arising from a partially filled tank on board ship is also possible. Therefore, the dynamic forces induced by the fluid in the tank can be presented as a function of these parameters.

An example of only one vessel is presented in this paper, and the method would still have to be verified for various sizes and types of ships to determine all of its limitations and before its introduction as a valid method for the industry use. However, it has been shown that for one selected geometry of the ship the results are very promising and that in future it may be possible to harmonize the behaviour of the ship in waves in the form of ready-to-use engineering formulas. Such approach could then be used for various naval architecture applications including assessment of safety of ships with flooded tanks.

## NOMENCLATURE

$A_{xx}$	-	total added mass coefficient
$A_{WP}$	-	water-plane area
$b_{BK}$	-	breadth of bilge keel
B or b	-	beam of ship or barge
$B_{xx}$	-	total roll damping coefficient
$B_e$	-	eddy making damping coefficient
$B_f$	-	skin friction damping coefficient
$B_L$	-	lift effect damping coefficient
$B_w$	-	damping from free surface waves (radiation)
BG	-	distance from centre of buoyancy to centre of gravity
$C_{xx}$	-	stiffness matrix
$C_B$	-	block coefficient of the ship
$C_M$	-	midship section coefficient
D	-	draft
$F_k$	-	force component, where $k = 1, 2, \dots, 6$ or "s"
g	-	gravitational acceleration
I	-	total moment of inertia
KG	-	distance from the keel to the c.g.

$L, l_s$	-	lateral dimension of the ship
M	-	wave exciting moment
OG	-	vertical distance (positive upward) from SWL to c.g.
$\Phi$	-	amplitude of roll motion (in degrees)
S	-	wetted surface area
$T_n$	-	wave period
t	-	time
U	-	forward speed (or current)
V	-	ship-displaced volume
ZX	-	z coordinate of metacentre or centre of gravity
$\eta$	-	kinematic viscosity of water
$\rho$	-	water density
$\omega$	-	wave frequency

## REFERENCES

- Ainsworth, 2005. Significant Wave Height - A closer look at wave forecasts.
- Andersson, J. and Pedersen, J., 2011. Capturing Dynamic Effects in Ship Tanks.
- Bole, M. et al., 2006. Integrating Parametric Hull Generation into Early Stage Design. *Ship Technology Research*, 53(3), pp.115–137. Available at: <http://dx.doi.org/10.1179/str.2006.53.3.003>.
- Bowditch, N., 1995. *The American Practical Navigator*.
- Cummins, W.E., 1962. *The Impulse Response Function and Ship Motions*.
- Das, S.K., Sahoo, P.K. & Das, S.N., 2006. Determination of Roll Motion for a Floating Body in Regular Waves. *Proceedings of the Institution of Mechanical Engineers, Part M: Journal of Engineering for the Maritime Environment*, 220(1), pp.41–48. Available at: <http://dx.doi.org/10.1243/14750902m01904>.
- Faltinsen, O., 1990. *Sea Loads on Ships and Offshore Structures*.
- Fujiwara, T. et al., 2009. Experimental Investigation and Estimation on Wind Forces for a Container Ship.
- Hardin, E., 2013. Simulating Wind Over Terrain: How to Build an OpenFOAM Case from GRASS GIS Digital Elevation Models.
- Hem Lata, W., Thiagarajan, K.P., 2007. Comparison of Added Mass Coefficients for Floating Tanker Evaluated by Conformal Mapping and Boundary Element Methods.
- ITTC, 2011. Numerical Estimation of Roll Damping – ITTC Recommended Procedures 7.5-02-07-04.5.
- Journee, J.M.J. and Massie, W.W., 2011. *Offshore Hydromechanics – 1st Edition – Chap. 6, 7, 8*.
- Journee, J.M.J., 2001. *Theoretical Manual of Seaway*, pp.2–35.
- Kawahara, Y., Maekawa, K. & Ikeda, Y., 2011. A Simple Prediction Formula of Roll Damping of Conventional Cargo Ships on the Basis of Ikeda's Method and Its Limitation. *Contemporary Ideas on Ship Stability and Capsizing in Waves*, pp.465–486. Available at: [http://dx.doi.org/10.1007/978-94-007-1482-3\\_26](http://dx.doi.org/10.1007/978-94-007-1482-3_26).
- Kraskowski, M., 2012. *Numeryczna Symulacja Zachowania Statku w Stanie Uszkodzonym – Technical Report*.
- Krata, P., 2013. The Impact of Sloshing Liquids on Ship Stability for Various Dimensions of Partly Filled Tanks. *TransNav, the International Journal on Marine Navigation and Safety of Sea Transportation*, 7(4), pp.481–489. Available at: <http://dx.doi.org/10.12716/1001.07.04.02>.

Mellbye Larsen , M., 2013. Time Domain Simulation of Floating, Dynamic Marine Structures Using USFOS, MSc Thesis, p. 17.

Salehi, M., Ghadimi, P. & Rostami, A.B., 2014. A more robust multiparameter conformal mapping method for geometry generation of any arbitrary ship section. *Journal of Engineering Mathematics*, 89(1), pp.113–136. Available at: <http://dx.doi.org/10.1007/s10665-014-9711-8>.

Salehi, M., Ghadimi, P. & Rostami, A.B., 2014. A more robust multiparameter conformal mapping method for geometry generation of any arbitrary ship section. *Journal of Engineering Mathematics*, 89(1), pp.113–136. Available at: <http://dx.doi.org/10.1007/s10665-014-9711-8>.

Salvesen, N., Tuck, E.O. and Faltinsen, O., 1970, *Ship Motions and Sea Loads*.

Schmitke, R.T., 1978. *Ship Sway, Roll and Yaw Motions in Oblique Seas*.

Szulczewski, P., 2017. *A Method of Identification of a Set of Parameters of Decisive Impact on Safety of Cargo Ships in Damaged Conditions*. PhD Thesis.

Traintafyllou , M.S., Bodson, M., Athans, M., 1983. Real Time Estimation of Ship Motions Using Kalman Filtering Techniques.

Tunaley , J.K.E., 2013. An Examination of the Taylor Standard Series of Hull Forms.

Ursell, F., On the heaving Motion of a Circular Cylinder on the Free Surface of a Fluid. *The Quarterly Journal of Mechanics and Applied Mathematics*, 2(2), pp.218–231. Available at: <http://dx.doi.org/10.1093/qjmam/2.2.218>.

Vassalos, D., 2007. Risk-based Design: Passenger Ships. *Proceedings of SAFEDOR Mid-term Conference*.

Wang, K. et al., 2012. Numerical analysis of added mass and damping of floating production, storage and offloading system. *Acta Mechanica Sinica*, 28(3), pp.870–876. Available at: <http://dx.doi.org/10.1007/s10409-012-0075-x>.

Webster, W.C., 1974. Development of a Technical Practice for Roll Stabilization System Selection, pp. 39, 40.