

Know your safety indicator – A determination of merchant vessels Bow Crossing Range based on big data analytics

Mateusz Gil^{a,b,*}, Paweł Koziol^c, Krzysztof Wróbel^a, Jakub Montewka^{b,d}

^a Research Group on Maritime Transportation Risk and Safety, Gdynia Maritime University, Morska 81-87, 81-225, Gdynia, Poland

^b Marine Technology Group, Department of Mechanical Engineering, Aalto University, P.O. Box 15300, FI-00076, Aalto, Finland

^c Waterborne Transport Innovation Foundation, Sapiehy 22, 83-050 Łapino, Poland

^d Faculty of Mechanical Engineering and Ship Technology, Gdańsk University of Technology, Gdańsk, Poland

ARTICLE INFO

Keywords:

Bow Crossing Range (BCR)
Automatic Identification System (AIS)
ship collision avoidance
maritime risk and safety
big data analysis
Maritime Autonomous Surface Ships (MASS)

ABSTRACT

Even in the era of automatization maritime safety constantly needs improvements. Regardless of the presence of crew members on board, both manned and autonomous ships should follow clear guidelines (no matter as bridge procedures or algorithms). To date, many safety indicators, especially in collision avoidance have been proposed. One of such parameters commonly used in day-to-day navigation but usually omitted by researchers is Bow Crossing Range (BCR). Therefore, this paper aims to investigate, what are typical, empirical values of BCR during routine operations of merchant ships, as well as investigate what factors impact this indicator and to what extent. To this end, a ten-year big dataset of real maritime traffic obtained from the Automatic Identification System (AIS) was used to provide statistical and spatiotemporal analyses. The results indicate that BCR is strongly related to the type of navigational area (open sea or restricted waters) but not with the dimensions or speed of ships. Among analyzed vessel types, passenger ships were noted as vessels that cross other bows at the closes ranges. Results of this study may be found interesting by fleet managers and developers of Maritime Autonomous Surface Ships (MASS). The former could utilize the results to provide revised operational guidelines for deck officers while the latter - propose an early-detection warning system based on empirical data for prospective MASS.

Abbreviations

AIS	Automatic Identification System
ARPA	Automatic Radar Plotting Aid
BCR	Bow Crossing Range
COLREG	International Regulations for Preventing Collisions at Sea
CPA	Closest Point of Approach
DCPA	Distance at Closest Point of Approach
DMA	Danish Maritime Authority
GPS	Global Positioning System
IALA	International Association of Marine Aids to Navigation and Lighthouse Authorities
LOA	Length overall
MASS	Maritime Autonomous Surface Ships
MMSI	Maritime Mobile Service Identity
OOW	Officer in Charge of Navigational Watch
OS	Own ship
PDF	Probability density function

SCC	Shore Control Center
TCPA	Time to Closest Point of Approach
TS	Target ship

1. Introduction

According to statistics, collisions at sea remain one of the most frequent types of maritime accidents [1]. With increasing traffic, the problem is far from resolved despite various actions being taken. These include, among others: implementation of operational procedures, improvements of training, and potential introduction of highly-automated or even autonomous merchant vessels [2]. What binds all these efforts together is that, at least in terms of collision avoidance, they are based on detecting and calculating the risk of collision between an own ship (OS) and a target ship (TS).

To this end, various approaches to this issue have been applied along with different indicators suggested being suitable for evaluating how likely the collision is. To this end, an indicator of an imminent collision

* Corresponding author at: Gdynia Maritime University, Department of Navigation, Jana Pawła II 3, 81-345 Gdynia, Poland.

E-mail address: m.gil@wn.umg.edu.pl (M. Gil).

<https://doi.org/10.1016/j.ress.2021.108311>

Received 15 August 2021; Received in revised form 22 December 2021; Accepted 26 December 2021

Available online 31 December 2021

0951-8320/© 2021 The Author(s).

Published by Elsevier Ltd.

This is an open access article under the CC BY-NC-ND license

(<http://creativecommons.org/licenses/by-nc-nd/4.0/>).

is defined in the International Regulations for Preventing Collisions at Sea (COLREG) as a constant compass bearing and decreasing distance between two vessels [3]. Additionally, other operational indicators are used, mainly Distance at Closest Point of Approach (DCPA) and Time to Closest Point of Approach (TCPA) [4–7] as these are readily available to a decision-maker under normal circumstances. They are calculated based on readings normally provided by navigational equipment, such as Automatic Radar Plotting Aid (ARPA) and Automatic Identification System (AIS) [8], carriage of which is required from most of the merchant fleet, as well as other vessels. Both have their advantages and drawbacks [9], but they do supply the conning officer (or Officer in Charge of Navigational Watch, OOW) with information (s)he is trained to interpret. There are, however, two other parameters that are also readily available from the same equipment: Bow Crossing Range (BCR) and Time to Bow Crossing Range (TBCR, also referred to as Bow Crossing Time BCT). Their significance for collision avoidance purposes appears to be under-investigated and perhaps underestimated, but they are said to be informative [10] and useful at least in some cases [11] including these, when CPA-based factors may fail [10]. As a matter of fact, more scientific effort is devoted to analyzing CPA-related factors than those of BCR [12].

To this end, a concept of the ship’s domain is usually applied [13,14]. Its geometric interpretation can be typically formulated as a set of

allowable CPA and a (relative) bearing on which it is achieved. Meanwhile, BCR is a distance in which one ship crosses ahead of another. Thus, as per the indicator’s name, in *crossing* scenarios, the BCR may be more meaningful for a navigator in interpreting a close-quarters situation. The *crossing* should be understood as a type of encounter when one ship approaches from the COLREG visibility sector of only one sidelight of another vessel. In simple words, one ship approaches the other from the former side, and not ahead or astern. Therefore, the *head-on* and *overtaking* scenarios are not considered in this study as in such cases, CPA should be used instead of BCR.

There exists an evident relation between the BCR and CPA and they should be used together depending on encounter situation to support the OOW’s situation awareness. In Fig. 1, four various ship encounters are presented in a simplified form using true motion view and true vectors depicting speed of the ships: A) when the interpretation of BCR may be more intuitive than CPA (the target approaches from the forward sector); B) when the BCR equals CPA (the target approaches perpendicular to the own ship); C) when the CPA is relatively small but BCR is negative (the target is abaft – overtaking scenario); D) when a large BCR has been changed into small CPA after target’s course alteration (change of the type of encounter from crossing into head-on). Concerning utilization of CPA and BCR and their time-dependent derivatives, firstly, the CPA and TCPA indicate only how close and when one ship passes

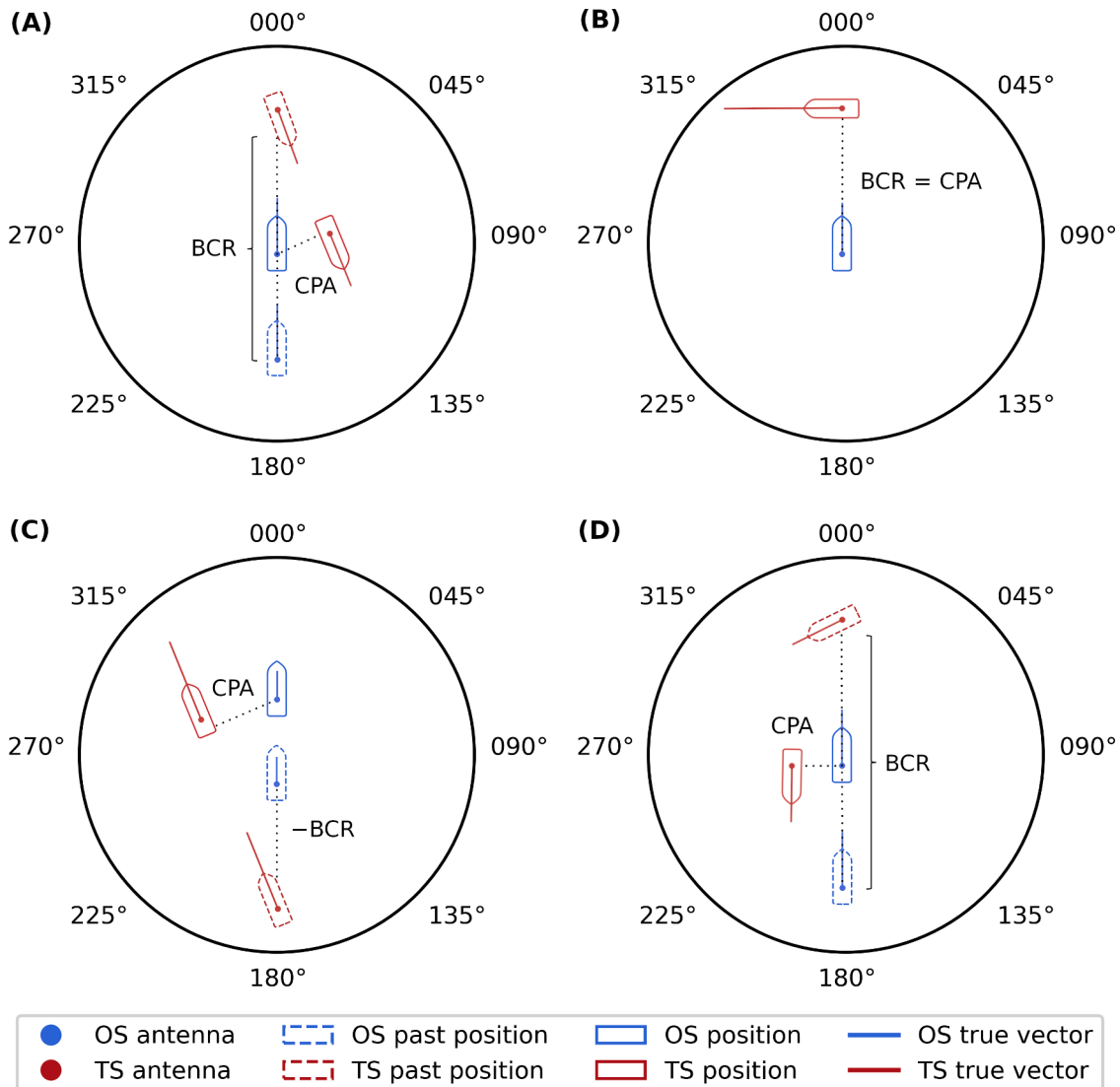

Fig. 1. Graphical comparison of CPA and BCR in various types of ship encounters using true motion presentation.

another. However, it is still unknown if the target passes ahead, astern, or from the side of the own ship. On the other hand, the (T)BCR value (positive or negative) provides information to the navigator about the ship passing ahead or astern and their mutual obligations under COLREG Rule 15. Secondly, it may be the case that CPA is relatively small for the vessel that has already crossed OS head in a quite large distance (equal to BCR) and then changed the course to reciprocal (head-on encounter). This can be expected especially in restricted waters where ships need to consider other traffic immediately after resolving a given encounter situation.

As (T)BCR is rarely used as a first-choice collision risk indicator, it is not mentioned in operational procedures, guiding the OOW on how to react to a dangerous situation. However, in the official, mandatory IMO's *Model Course on Radar Navigation at Operational Level* (1.07), the BCR is directly mentioned as one of the indicators (along with CPA) that should be understood and used by the OOW in an assessment of collision risk to "avoid small predicted passing distances" [15]. There is therefore no widely-accepted standard of what minimum BCR shall be maintained in what circumstances, as it is for CPA. For the latter, it is normally suggested that it shall not be less than 1 nautical mile, but other values can also be found [15–17]. Moreover, there is no literature on what values of BCR are normally maintained in maritime operations. Meanwhile, BCR can arguably be found more intuitive by OOWs at least in some circumstances, such as in encounters when CPA is low but BCR is high, as is the case when ships approach each other from the forward of the beam [10].

The BCR is routinely used by navigators as a secondary, quantitative indicator of the nature of the ship-ship encounter, with (T)CPA being the primary one. The application of both these parameters is directly related to the obligations imposed on vessels by COLREG. The CPA is a hands-on interpretation of a universal Rule 8 d) which requires that ships pass each other at a safe distance [3]. Meanwhile, the requirement of Rule 15 (which only applies when ships are in sight of one another) is that power-driven vessels shall avoid crossing ahead of those on their starboard in situations involving the risk of collision. Thus, the awareness of how far the OS will pass ahead the TS (BCR) can advocate on whether the obligation of Rule 15 along with this of Rule 8 d) (CPA) is met. Implemented in radar systems and used as their feature already in the early 1980s [18], BCR is presently also an optional functionality of advanced Integrated Navigation Systems (INS), [19].

In open sea navigation and crossing situations, it might prove sufficient to evaluate BCR from the perspective of both vessels involved. It seems to be especially important when putting Maritime Autonomous Surface Ships (MASS) in the spotlight. Autonomous or remote-controlled merchant vessels will be operated by either decision-support systems or data-driven algorithms. The former should obtain some critical values to warn on their bases an operator in the Shore Control Center (SCC) or inform the system to take appropriate action. One of these critical values, so-called *leading safety indicators* in MASS collision avoidance may be BCR [20]. The latter should make and execute safety-critical decisions based on the data fed by sensors and their comparison against a control sample. Such a sample would involve trends and patterns of ships movements as investigated herein. To this end, the objective of this research is to investigate the empirical values of BCR produced in merchant ship-ship encounters based on maritime traffic analysis. To achieve this, a large set of the AIS data gathered by the Danish Maritime Authority was analyzed. The results of this paper could be used twofold. Firstly, for re-defining OOWs' approach to interpreting encounter-related data. Secondly, may be applied in determining values that may be used as leading safety indicators in collision avoidance algorithms for MASS. Thus, regardless of the way the results are utilized, the findings of the paper will contribute to improving maritime safety. The study also aimed to investigate, what are typical values of the BCR during routine ship operation depending on certain operational parameters of the ship and navigational area. To achieve these objectives, statistical and spatiotemporal analyses were carried out using real AIS

big data.

The remainder of this paper proceeds as follows. Section 2 introduces an algorithm designed for BCR calculation as well as a description of the AIS dataset used. Section 3 presents the results of the study along with their analysis. In Section 4 findings, potential applications, limitations, and future work are presented and discussed. Section 5 concludes the paper.

2. Materials and method

The AIS data was investigated previously for different purposes [21, 22]. Van Iperen, 2012 [23] and Liu et al., 2019 [24] used it for detecting dangerous encounters while the studies presented in [10,12,25–27] were more specific and targeted near-misses. Accident risk and its influencing factors were also identified based on AIS messages [28–34], including spatial approaches [35–37]. AIS data were also widely used in the determination of empirical ship domains [38–40]. Moreover, AIS was also utilized for studying emission inventories [41], oil trading routes [42], disaster preparedness of coastal communities [43], as well as other applications [44]. This advocates that AIS data can be used for various applications on multiple levels of detail, despite known issues with relevant data trustworthiness and reliability [45–47]. These are usually related to human errors [48], software, or hardware deficiencies and are considered inevitable [49].

In order to provide a reliable analysis of maritime traffic based on real empirical big data, a large set of AIS records provided courtesy of the Danish Maritime Authority (DMA) was gathered. The data consist of ten years of (mostly) high-resolution records from 01 January 2011 to 31 December 2020. In terms of geographical extent, most ship positions are located in the area of the Danish straits. There were however ship positions noted also far away from the Danish waters and out of the range of their land-based stations. These were in the vast minority and likely occurred due to the fact that DMA has cooperated regionally and globally on data exchange [50]. This was made, among others, by the IALA-NET service where partner states share their data. Nevertheless, in this paper, the main focus is given to the region narrowed to the North Sea west of Danish straits, the straits themselves, and the southern Baltic Sea. Inland waters and seaports have been excluded. The detailed map of the geographical area considered in the study with a density map presenting all AIS records from the dataset is depicted in Fig. 2.

The AIS records were obtained in a form of text files containing comma-separated values (*.csv) with a total size exceeding 7.7 TB. The following information was extracted to carry out BCR computations and provide further analysis of the results:

- a) MMSI (Maritime Mobile Service Identity) number – to identify a unique vessel;
- b) Timestamp – to identify unique time;
- c) Receiver (mobile) type – to filter data during import;
- d) Latitude and longitude – to project ship positions and obtain her track;
- e) Speed over ground – to split tracks when vessel stops and filter data before analysis;
- f) Heading – to determine BCR during computation stage;
- g) Antenna reference point or length and breadth of the vessel depending on the year – to obtain ship dimensions for BCR calculation;
- h) Ship type – to filter data by selected ship types during analysis;
- i) Navigational status – to filter data by selected status during analysis.

To handle a large set of input data, process AIS records, calculate BCRs, and scrutinize the results, in-house software for maritime traffic analysis was developed. In general, the algorithm used in this study can be divided into three stages: I) import data; II) compute results; III) analyze results. These are presented in Fig. 3 with their main components on the high-level flowchart of the software created for data

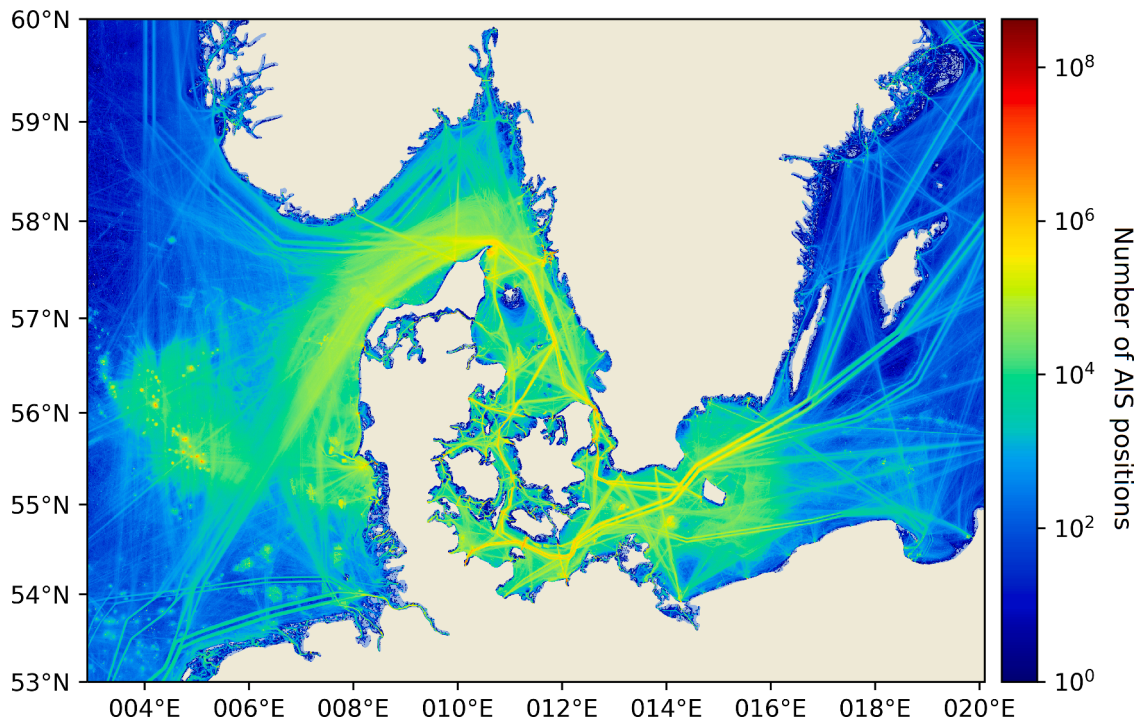

Fig. 2. Density map depicting at least one AIS position based on the entire imported dataset.

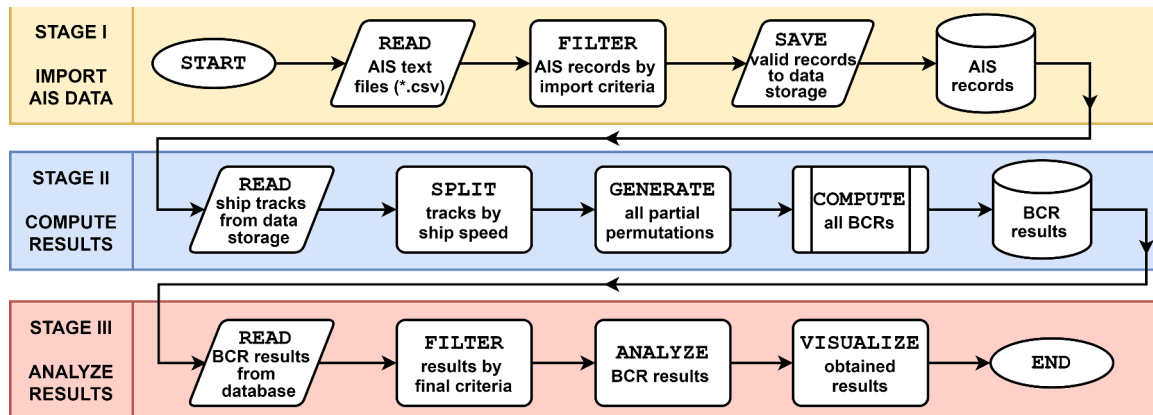

Fig. 3. The high-level flowchart of the software used for data handling and analysis.

handling.

In stage I of the algorithm execution, AIS data is processed. It consists of reading and parsing input files, filtering and cleaning AIS records, and finally exporting valid ones to the data storage. The setting of import criteria is important as AIS messages are burdened with some typical errors described widely in the literature [51–53]. From the viewpoint of traffic analysis to the most important ones belong, for instance, missing or undefined values; different static information transmitted for the same vessel (like different dimensions); erroneous values of ship position (offsets or out of the limits), speed, etc. Therefore, after parsing, the unreliable values in AIS records (12.3% of the initial dataset) have been discarded to avoid uncertain results so as misinterpretation during their analysis.

Stage II is focused mainly on computing BCRs. Firstly, the positions of each ship are read from the data storage and projected into the Cartesian coordinate system using a dedicated package for geospatial analyses [54]. Secondly, the positions of each ship are merged into a separate trajectory (track) for a particular voyage. Then, the tracks are split into segments to detect when the normal proceeding of a ship is

finished (and when it starts again, using a minimum speed threshold of 0.5 knots). Finally, all determined tracks for unique pairs of the ships are combined without repetition (so-called *partial permutations*) to find their intersections.

Once all intersections of the tracks are found, the sequence of BCRs computation is executed. As this part of the software directly affects the results, it is depicted in detail in Fig. 4 where a flowchart for a single BCR calculation is presented. The algorithm starts with linear interpolation of the successive positions before the occurrence of the intersection. Then, the limit values for the computation stage (criteria) are verified. These arise from operational issues, which are considered to keep the BCR results as reliable and close to the real ship operations as possible. Thus, the maximum distance (line of sight) at which the BCR is calculated is set to 6 NM. This value is often used as a reference for the start of collision-avoidance action. Finally, two angular criteria should be met, namely TS should be almost directly before the bow of OS as well as ship encounter should not be while overtaking or head-on situation (as ships may proceed in the fairway, for instance).

The angular conditions are achieved by checking values related to

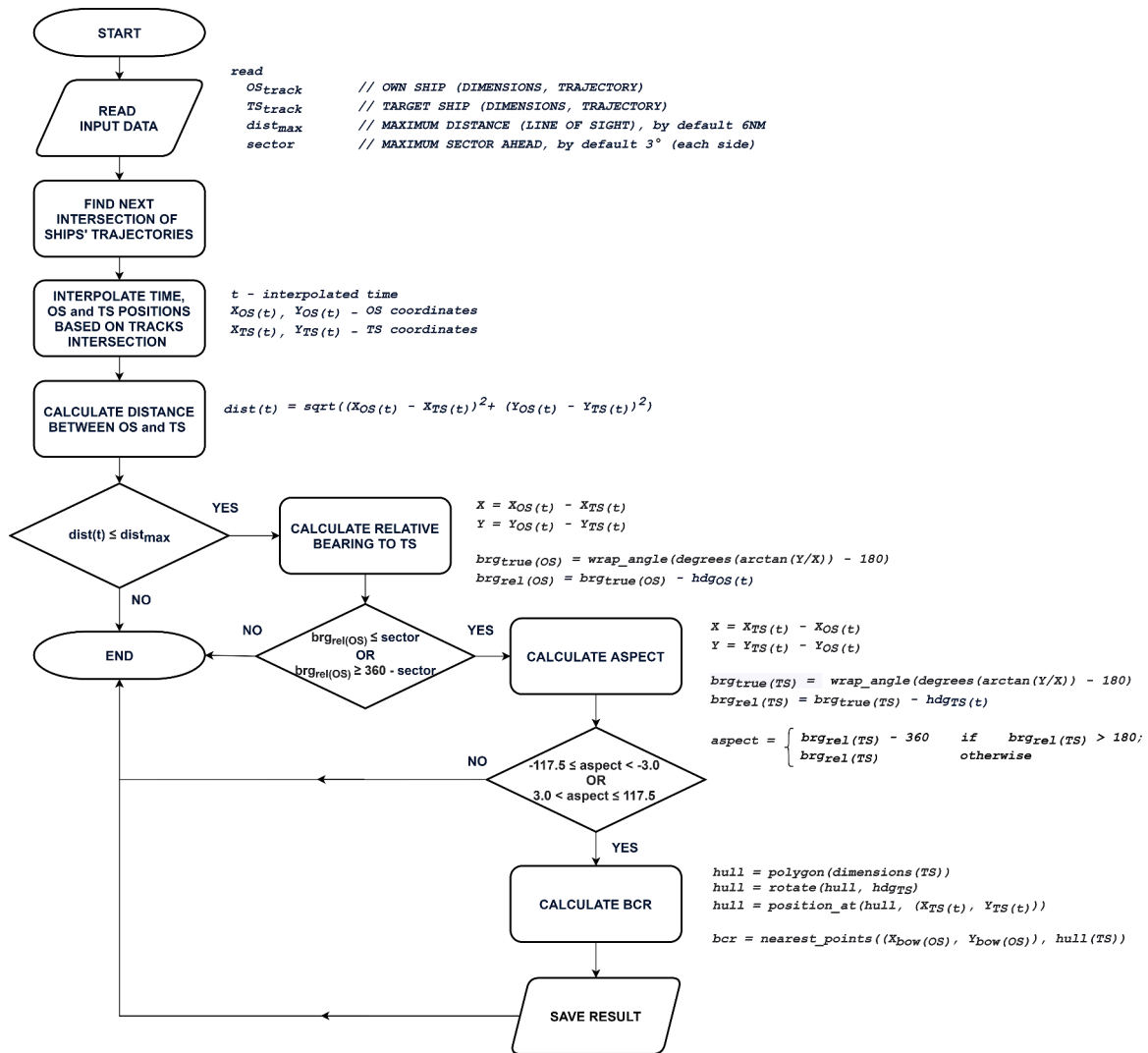

Fig. 4. The procedure of a single BCR calculation.

the COLREG requirements, i.e., for visibility of navigational lights. Typically, the head-on encounter (bow-position against a target) is determined when OOWs on both ships can respectively see both sidelights at the same time (Rule 14, b)). As per sectors of the lights given in COLREG (Rule 21, b)), this situation occurs only right ahead of the ship. There are however the technical requirements for all navigational lights where horizontal sectors with practical, not theoretical cut-offs are presented (Annex I, p. 9, a) i) ii) [3]. As depicted in Fig. 5, the allowable

cut-offs for sidelights in the forward direction may reach up to 3°, while abaft the beam up to 5° outside the sectors given in Rule 21. Thus, to take into account the worst navigational scenarios (the largest possible sector of the line of sight), the BCR is considered when: i) the aspect is within the total sector of sidelight including practical cutoffs ±(3°, 117.5°]; ii) the TS should be ahead of OS bow within the sector ± 3°. In both described conditions 0° means direction right ahead of the OS bow, negative values denote port side, while positive ones starboard side angles (please see Fig. 5).

When all conditions for a ship encounter are met, based on the reference points of the vessels' antennas, their dimensions are utilized to build up polygons imitating the hulls. Note, that for ships where only dimensions were provided instead of the specific antenna reference point (older AIS messages), the antenna position was assumed to be at 0.72 of ship length overall (LOA) and 0.50 of her beam. These values were delivered through statistical analysis of merchant vessels' antenna reference points specified in the newer AIS records. Afterward, the distance from the edge of the OS bow to the edge of the TS hull is calculated with respect to the ships' angular positions (so-called *nearest points*). Thanks to this approach, the BCR is not overestimated in the scenarios when TS proceeds almost on the head-on course. By this, the requirement of the worst navigational condition is maintained. An exemplary BCR situation is plotted with the line of sight sectors and annotations in Fig. 6. Eventually, all computed BCRs are exported to the database and

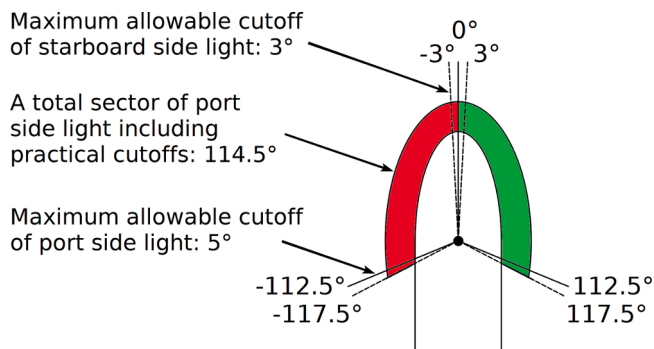

Fig. 5. The sectors of navigational lights considered in the BCR calculation process.

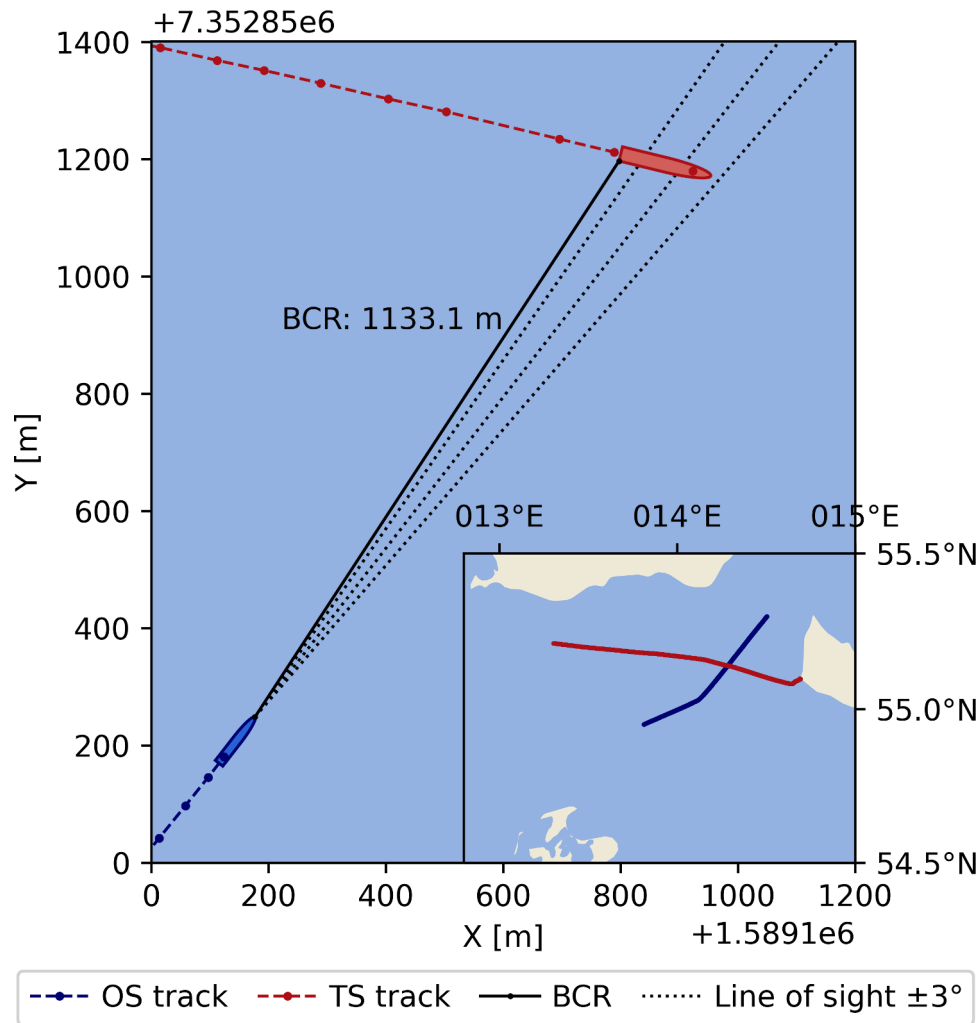

Fig. 6. Exemplary ship encounter with annotations during BCR calculation process.

stored.

Stage III runs the statistical analysis of the results and visualizes them. It begins with reading previously calculated BCRs. Besides unreliable values in the AIS records rejected during data import, there are also some limit/specific values, which should be selected for the analysis due to the objectives of this paper. Therefore, the results are filtered, so as to put merchant ships into the spotlight. The following has been addressed:

- Based on AIS records, all other ship types have been rejected, so only tankers, cargo, and passenger ships were taken into account. This has been made to avoid misinterpretation of the results when some service vessels intentionally cross the other ship's bow at a close range (like tugs, pilots, etc.);
- Only the vessels at speed between 3.5 and 30 kts are taken into account to avoid high-speed crafts or drifting vessels;
- The only navigational status normally set during a routine voyage (*underway using engine*) is considered for both OS and TS. This has been made to maintain the same level of COLREG priority, i.e., to not skew results by abnormal maneuvers made by *not under command* vessels, for instance;
- The maximum allowable time between two known ship positions (taken from AIS records) cannot be larger than 60 s before the BCR point to maintain the high quality of the BCR results;
- The distance between these positions (0.5 NM maximum) is verified to reject GPS glitch cases (abnormal but fleeting position offset). This

is also done to reduce uncertainties resulting from a linear interpolation of the ship positions and their speeds when the intersection of trajectories (BCR point) occurs during the calculation process.

The main filtering stages along with the number of results left in the database are depicted in the funnel chart given in Fig. 7. After preparing the final set of the narrowed results, the statistical and spatiotemporal analyses are conducted. These allow for the determination of empirical and best-fit theoretical distributions of the results, verification of results for geographical areas (various types of navigation), and correlation of variables. The software ends when selected variants of analyzed results are visualized.

3. Results and analysis

To address the objectives of the study, the investigation of the BCR results has been divided into two parts – statistical and geospatial. Meanwhile, the entire geographical area has been divided into three subregions as depicted in Fig. 8, which are used for further presentation and analysis of the results. The regions were limited based on traffic intensity, as presented in Fig. 2, as well as their navigational characteristics: 1 – open sea regions (A – west, B – east); 2 – restricted waters (the Danish straits). In further paragraphs of the paper, both open sea areas (1) are always jointly placed on the left, while restricted waters (2) are on the right part of each statistical chart, for easier interpretation of the figures.

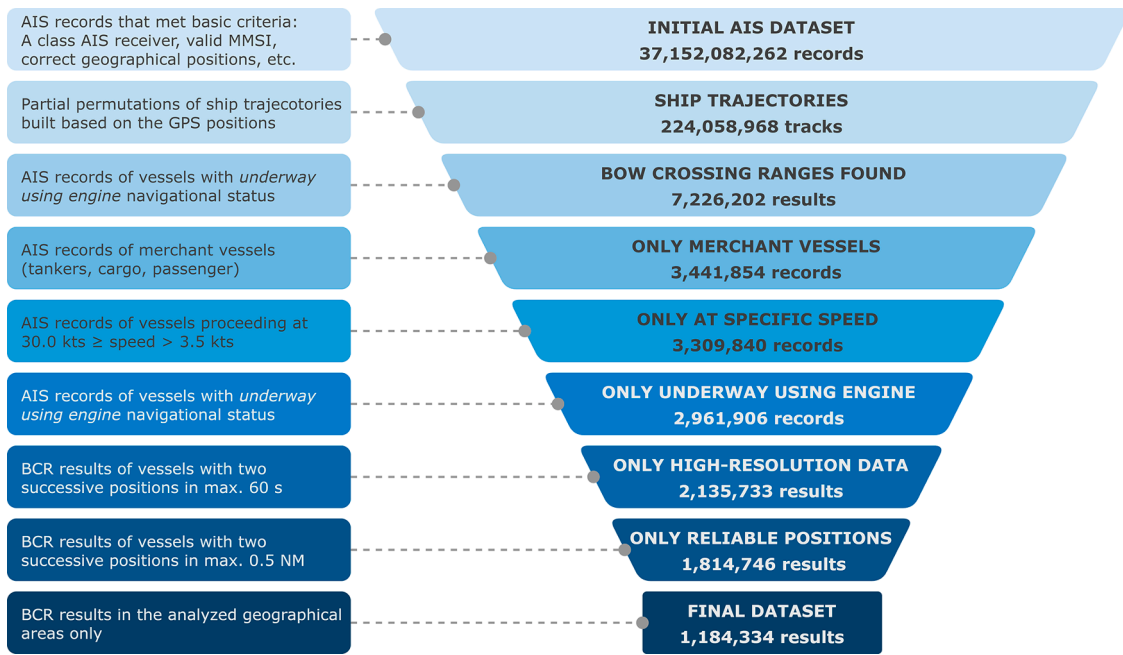

Fig. 7. Funnel chart with the major filtering steps.

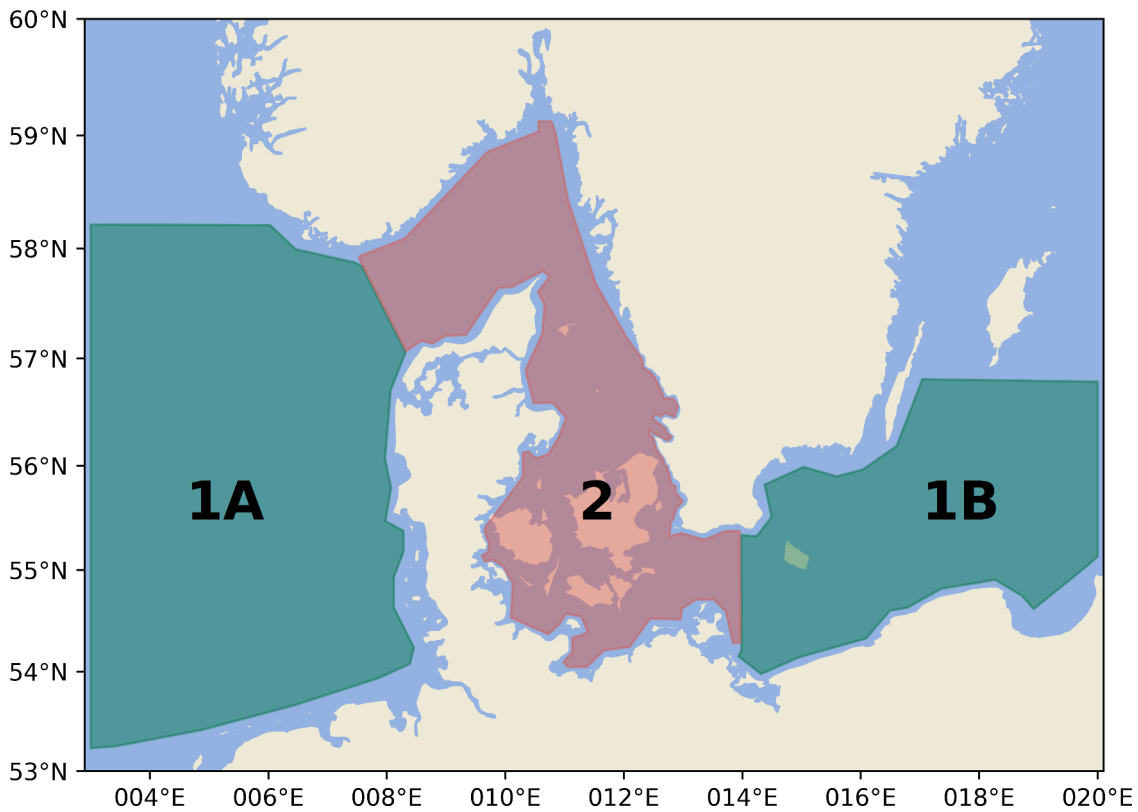

Fig. 8. Division of the investigated geographical area into subregions.

3.1. Statistical analysis

Concerning basic statistical characteristics of the BCR results, firstly the empirical distributions were verified for ship encounters by vessel type, a kind of navigational area, as well as the time of day. These are depicted in Fig. 9 as histograms, in Fig. 10 as letter-value plots (box-plots), and in Fig. 11 as violin plots, respectively.

As can be observed, the set of the results collected in the restricted waters is larger by almost a million instances than in the open sea areas. The number of instances per type of encounter (relative size of subsets) differs depending on the navigational type of the area. When navigating at high seas, a share of passenger ships was significantly smaller than in restricted waters (acting as both OS and TS). In restricted waters, this ship type consists of an important part of the entire dataset and is ahead

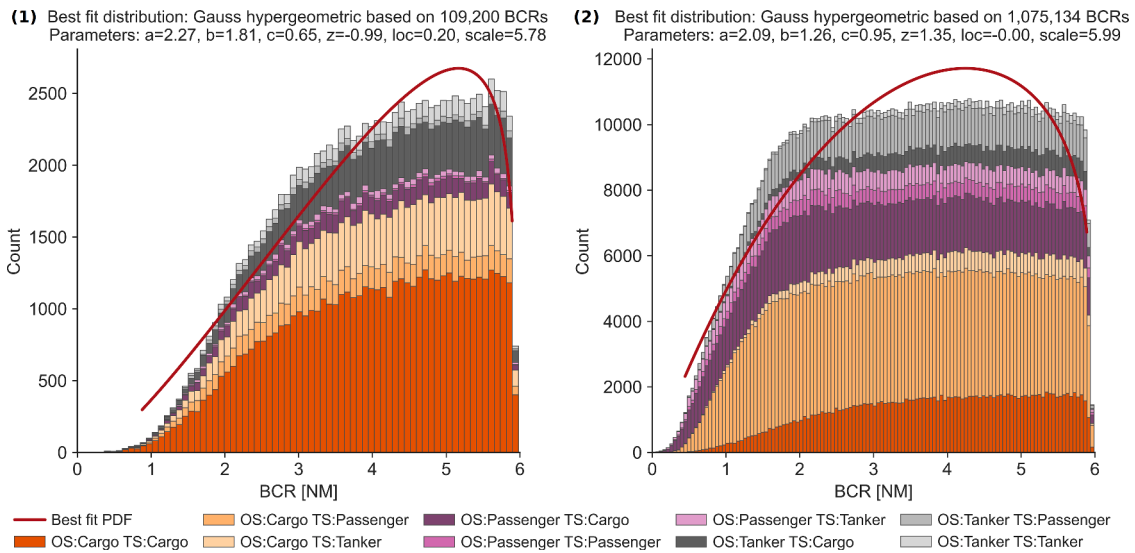

Fig. 9. Histograms with best-fit PDF (probability density function) of BCRs in the open sea areas (left) and restricted waters (right); ship encounters per vessel type.

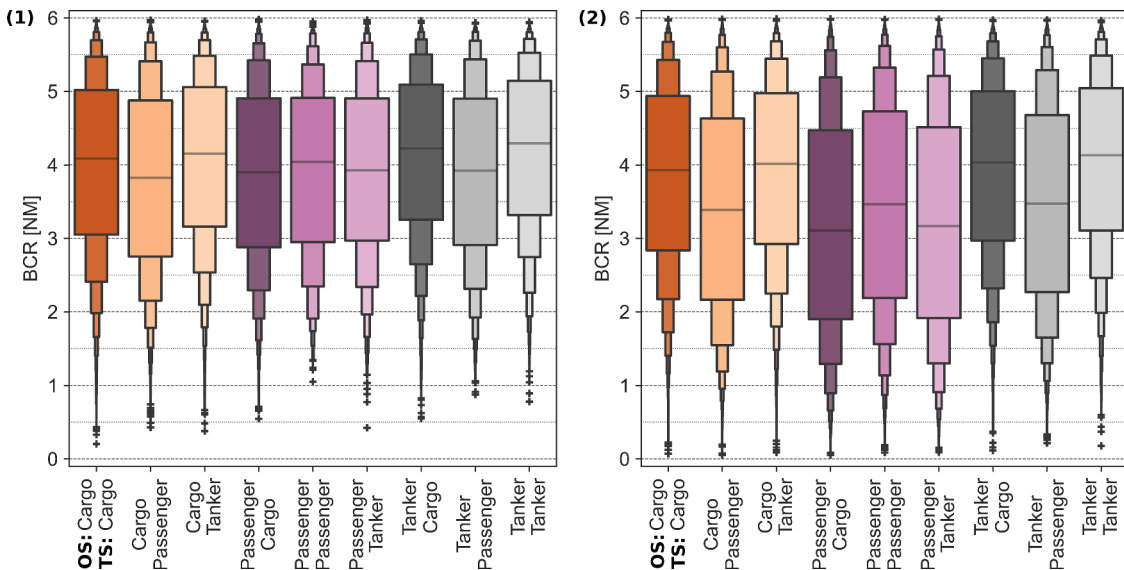

Fig. 10. Letter-value plots presenting BCR results in the open sea areas (left) and restricted waters (right); ship encounters per vessel type.

of the tanker group. It is noteworthy that when navigating in restricted waters, the groups where passenger ships are observed as TS (a ship passing ahead of the bow of OS, thus impeding her passage) are the largest among other types. This is likely related to the nature of their operation, as there is a prevalence of ferries and Ro-Pax ships in short sea service over cruisers in the region investigated. Therefore, it was expected that passenger ships operating several times a week on constant routes which cross main fairways will significantly impact the passage of other ships. On the other hand, at open sea cargo vessels constitute the vast majority of ship types involved in the encounters, so as bow-crossing situations.

For both areas, the number of observations stabilizes in near-maximum value (per bar) at different BCRs. In other words, the number of BCR values does not significantly change after a specific range is met. It is important to investigate BCRs in those points as a repeated number of observations without an increase of BCRs may result simply from the maximum distance considered in the line of sight during the calculation process. In the open sea, an increase of observations stabilizes at around 3.5 NM, while in restricted waters around 2.0 NM. Thus, as expected because of the characteristic of the navigation type, the BCR

is smaller in the straits (due to less room to perform a safe crossing).

Despite the differences in the shares of ship types in the distributions of the results, the shapes of the histograms given in Fig. 9 are quite similar. To allow easier modeling of the BCRs in the future (for instance as leading safety indicators of MASS), the best theoretical distributions were fit to the empirical data. Among 86 various probability density functions (PDFs) [55], the Gauss hypergeometric distribution has been matched to both histograms (but with different parameters) as the best-fitting one.

Concerning the ship type, especially in restricted waters, the encounters where passenger ships were involved have been classified as the most dangerous ones, i.e., with the lowest values of BCRs. It is of note, that most of the BCRs below 1 NM, as well as almost all of the BCRs below 0.5 NM, were caused by passenger ships passing ahead of other ships. Even if the area, transverse routes, and shipping type do not help them keep safe distances it is still surprising as passenger vessels should be expected to maintain the highest standards of safety. This may be due to the fact that crews of ferries feel confident navigating in the same geographic area for a long time and thus they limit the margins of safety. In contrast, on board another safety-critical type - tankers - longer

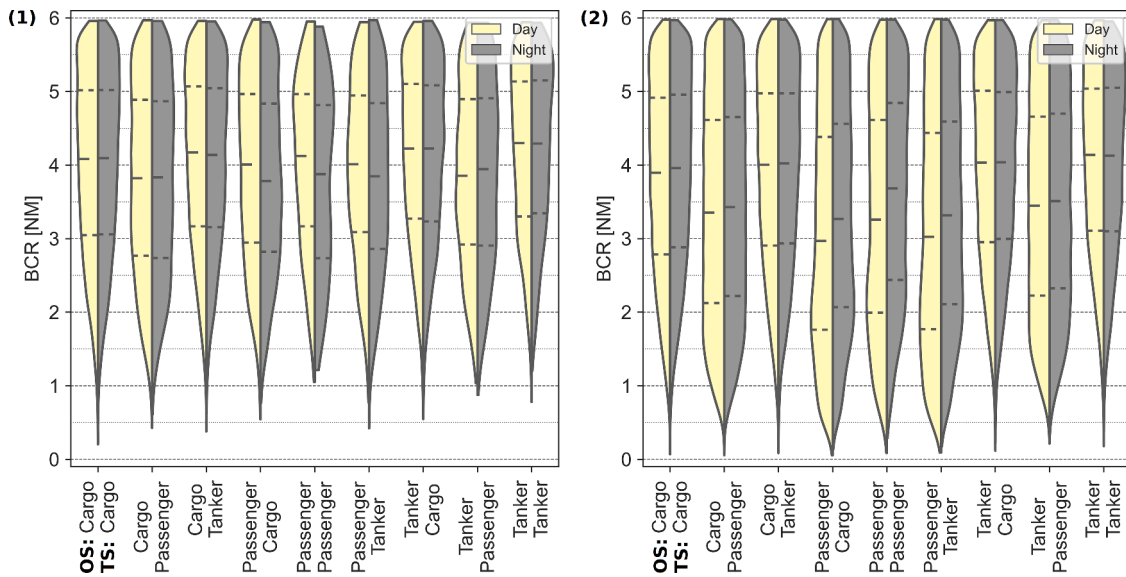

Fig. 11. Violin plot presenting BCR values observed during day and night in the open sea areas (left) and restricted waters (right); ship encounters per vessel types.

distances in crossing scenarios are kept (see for instance quantiles in Fig. 10 and especially the medians).

Continuing the analysis of vessel types involved in an encounter as well as a kind of navigational area, the impact of daylight on the distribution of observed BCR values was also scrutinized. The violin plot in Fig. 11 depicts BCRs calculated for open-sea navigation (left – 1) and restricted waters (right – 2) concerning ship types noted in close-quarters situations during day and night, respectively. The analysis was conducted with regard to the time of sunrise and sunset on a given date and in a specific geographical position. Therefore, the duration of daylight differs in various days and locations. Such a method allows for an accurate determination of time of day during ship encounters when the BCR scenario appeared.

It is of note that generally, daytime has a negligible impact on a change of the distance at which a vessel crosses another ship’s bow. As presented in Fig. 11, there are many ship encounters per vessel type, where medians, quartiles, or even distributions’ shapes are almost the same for night and day samples. Interestingly, the type of navigational area (open sea or restricted waters) also does not strongly impact BCR

concerning aspect of the time of day. The only clear differences between compared results between day and night can be observed in the encounters where passenger ships are involved, especially in the role of OS. Although the difference is noticeable, it still remains practically insignificant and fluctuates around 0.2 NM in open sea areas and 0.3–0.4 NM in restricted waters. Noteworthy, the tendency in the values noted during night and day for passenger ships differ between types of navigational areas. In the open sea, surprisingly the smaller BCRs are noted during nighttime, while in restricted waters vessels pass each other closer in the daylight.

Besides the analysis of the empirical data distributions, also correlations of numerical variables with BCR were investigated as presented in Fig. 12. Length overall of OS and TS, as well as the speeds, were taken into account to find if and how they impact BCR. To this end, the Pearson correlation coefficient of each variable has been calculated. As depicted, a very weak positive correlation exists only on the lowest BCR ranges (up to 2 NM) regardless of the navigational type of the area. Therefore, although there are notable differences in the values of the BCR between the open sea and restricted waters, the ships’ speed and their length do

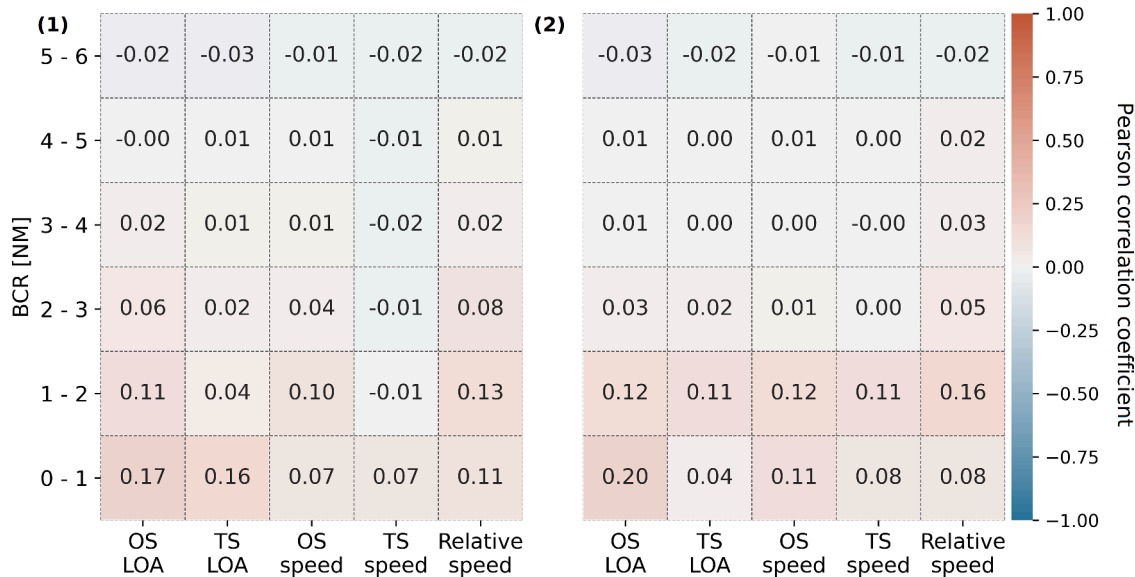

Fig. 12. Correlation matrices of the BCR values in the open sea areas (left) and restricted waters (right).

not impact bow-crossing distance in these areas. The influence of the speeds on BCR is found to be negligible, which is quite unintuitive from a hands-on navigational experience of the authors as it indicates that faster ships do not react in a different way than slower ones. This in turn stemmed from the obligations of COLREG Rule 6 and its interpretation given by Cockcroft & Lameijer, 2012. Therein, it is said that “A vessel may be unable to take proper and effective action due to the speed being too high” [16], which implies that high-speed vessels shall be particularly cautious in performing collision avoidance, e.g., pass other vessels at a greater distance. Similarly, ship dimensions were also considered as more important and influential but they were found to be characterized by a very weak correlation with BCR. Noteworthy, over 2 NM there was no correlation found, nor was any influence noted between selected variables and BCR.

3.2. Spatiotemporal analysis

To verify if there exist some dependencies related to the characteristic of the geographical region, a spatiotemporal analysis was performed. Firstly, BCR results are projected onto a Mercator chart in two different ways: i) as a density map to check the frequency of BCR occurrences; ii) as a colored scatter to check the distribution of BCR values. As depicted in Fig. 13, three main hotspots can be noticed, especially in restricted waters. These are located as follows:

- 1 At the passage from Skagerrak to Kattegat in the north;
- 2 Fehmarn Belt and Bay of Mecklenburg on the south;
- 3 At the entrance to the south-western Baltic (Arkona Basin).

The largest identified hotspot is the Fehmarn Belt (magnified in the black circle). As can be observed, the significant clusters of BCRs are always located on the crossings of maritime routes, especially connecting separate islands or neighboring countries. This is most likely related to constant passenger traffic where the routes of cargo vessels cross with ferries operating in short service. The situation is similar to the BCR values presented in the OS positions in Fig. 14. These in the vast majority are correlated with the traffic of passenger ships as well. However, it is noteworthy that the geographical distribution of the BCR values is much more unified. Even in the Danish straits there still can be observed a significant number of bow-crossings above 4 NM (marked in dark

colors).

As it was proved that ship type affects the results of the study at most, the spatiotemporal distribution of BCRs for a particular type of vessel was verified. Therefore, in Fig. 15, OS positions in the BCR time are plotted for cargo, passenger ships, and tankers.

In the analyzed dataset (a decade), a total of 51,679 unique MMSI of the merchant ships have been collected. These were considered as unique vessels, among which 33,005 cargo ships, 5296 passenger vessels, and 13,378 tankers were distinguished based on their static AIS data. Apparently, the small number of unique passenger vessels must be related to their frequent operation on constant, short routes, and tendency to pass rather close ahead of other ships to assess their navigational risks.

The investigation of ship speed during bow-crossing in the analyzed geographical area (see Fig. 16) reveals that typically a target ship proceeds from 9 to 15 kts when crosses another’s bow. This operational parameter is also strongly related to the vessel type. It is clearly visible when the highest speeds are analyzed. The markers presenting the speed range from 21 kts upwards (dark colors) overlap with routes of passenger ships, as the ferries are usually fast vessels.

4. Discussion

The performed analysis allowed for a determination of the bow crossing range (BCR) of ships in different aspects of encounter situations. The latter included geographical breakdown, daytime, involvement of different types of merchant ships, their speeds, and lengths. Real-traffic data spanning 10 years were analyzed to this effect. The results indicate that the type of vessel has the greatest importance on the size of BCR. Moreover, most of the situations with small BCR occurred in restricted waters which further enhances the risks associated with navigating in already demanding regions. Nevertheless, it is of note that from the practical point of view, the vast majority of obtained results (understood as a larger part of the distribution for a given sample, excluding the outliers) stay within the commonly accepted industry standards. Thus, it appears that OOWs apply the CPA-related thresholds to BCR as well.

The results can be used two-fold. In a first approach, they depict the operational aspect of merchant vessels passing ahead of each other and hazards associated with the situation. To simply put this, the smaller BCR, the higher risk of miscalculating the maneuver and eventually

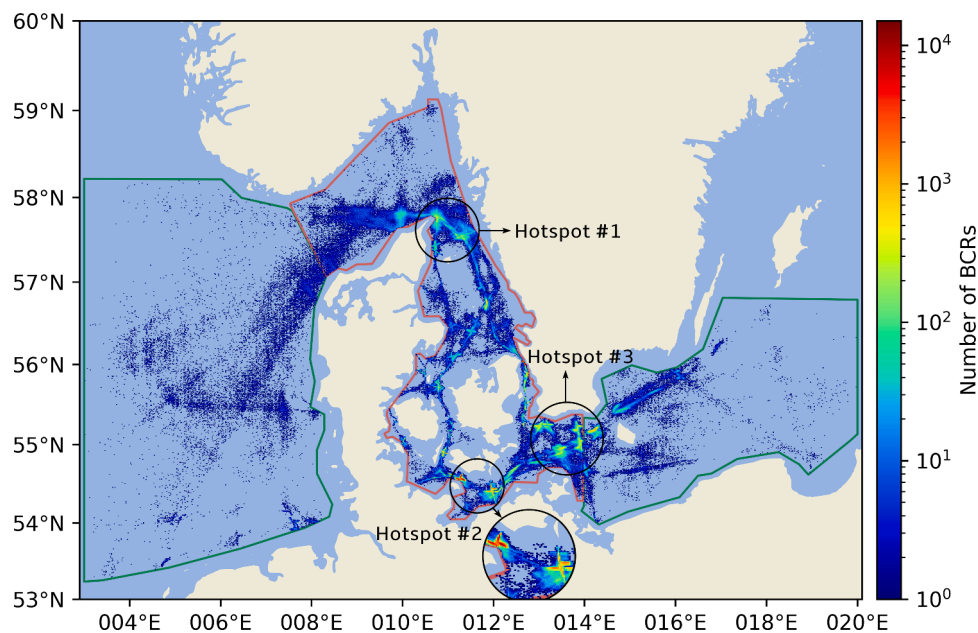

Fig. 13. Hotspot map with the density of BCRs.

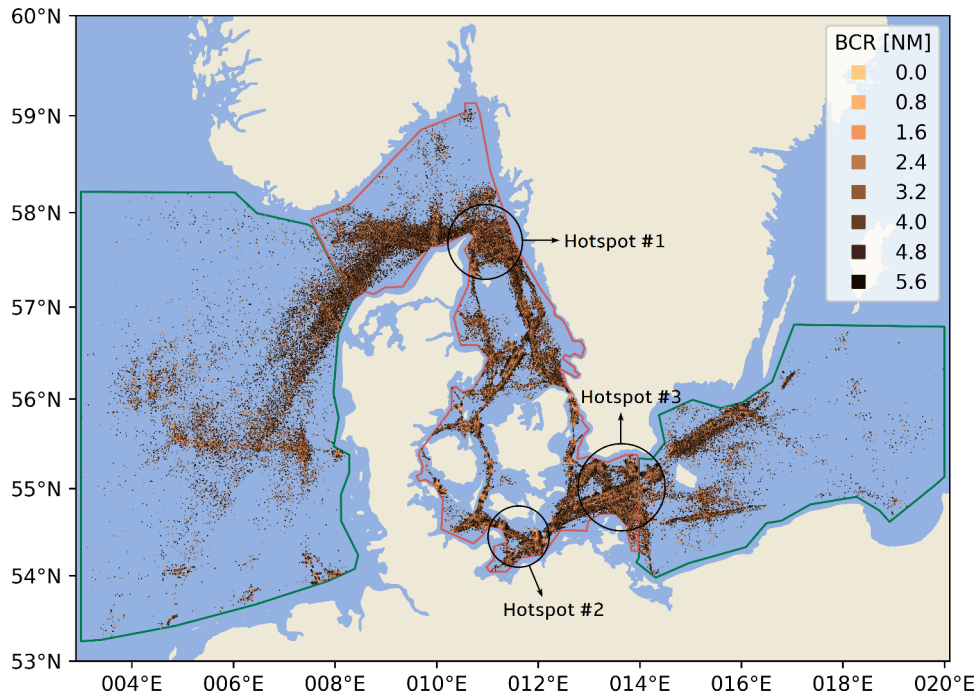

Fig. 14. Locations of the BCR results with respect to the OS position.

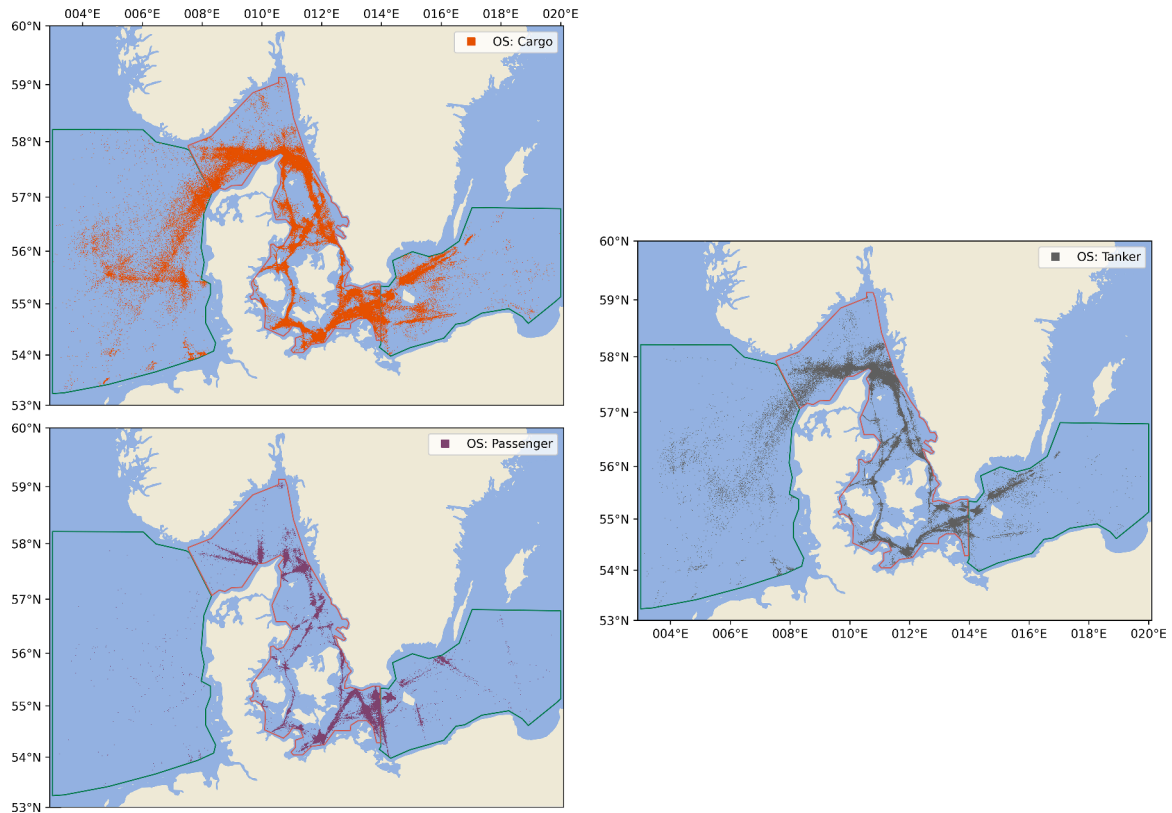

Fig. 15. Spatiotemporal distribution of OS positions in the BCR time per ship type.

collision. In this sense, the results are not surprising as it is widely known to navigators that near-shore navigation in dense traffic brings about additional dangers and calls for increased attention. The herein obtained results can assist navigators and ship managers in promoting safe behaviors and operational procedures. With the question of *what passing distance is safe?* still valid, our results provide an indirect answer by

empirically pinpointing what passing was in fact executed. It appears that BCR limits executed by respective OOWs depend on many factors, just as does the CPA [8,16,17]. Among these, the impact of other ships' movements and traffic density, as well as the professional experience of involved OOWs, can be named. Both are non-trivial to elaborate on as it would require additional data on each of the encounters, and data that

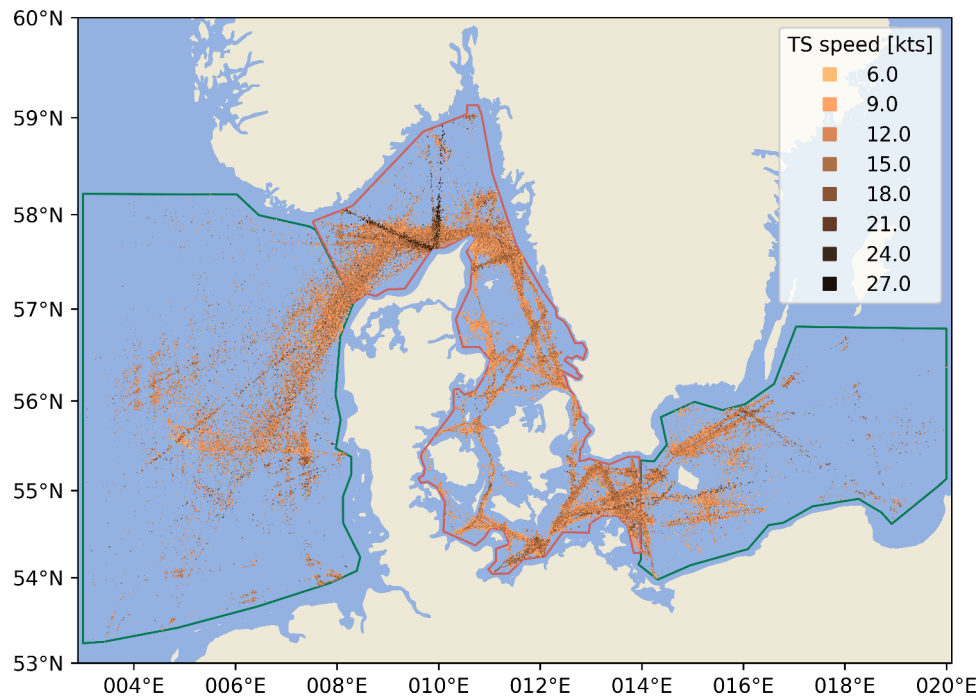

Fig. 16. Spatiotemporal distribution of TS positions in the BCR time per ship speed.

would be either extremely complex (traffic) or virtually unobtainable (individual OOWs traits).

The other application of the results lies within the upcoming implementation of MASS. It has been raised [20] that operations of these vessels will need to be based on the application of leading safety indicators, among which BCR can be listed. However, identifying an indicator is merely a first step towards successful operation, the second being defining its reference values. To this end, knowing the actual values of BCR in real-life operations of manned ships, as well as its probability density functions and factors with which it was correlated can provide such a reference. By this, algorithms controlling MASS might identify *abnormal* values of BCR and execute pre-programmed actions to solve the potentially dangerous situation. Note that *abnormal* can be also considered a synonym to *dangerous* in logic-based algorithms.

In both abovementioned applications, BCR seems to be an important indicator as it almost always takes into account the unfavorable mutual arrangement of the ships – something that cannot be said about CPA, for instance. With this, the angular and relative position of ship hulls during an encounter can be understood. It is widely known in seagoing practice that due to the construction of the vessel, minimizing of ship collision effects is provided by moving ships bow-to-bow as these parts of the ships are additionally strengthened. And this strengthening is done precisely to limit the damage. Therefore, BCR (crossing encounter) can be considered more dangerous, because it can result in a potentially more destructing and disastrous accident, as it considers the bow-to-side approach.

4.1. Limitations and uncertainties

Like every study, this one also is burdened by some limitations, while results include uncertainties. These drawbacks in the vast majority concern errors or incomplete information in AIS data. Despite the authors' best efforts to maintain high-quality results by many validation and filtering stages of the final dataset, some simplifications were made. The following can be listed:

- Utilization of linear interpolation in the determination of the BCR positions. During this stage of computation, it was assumed that each ship proceeded with a constant speed during each AIS record. To reduce uncertainties and make the results as reliable as possible, a required time between two successive positions between the BCR point was set to 60 s.
- Possibly unreliable dimensions of several ships provided via AIS (or several different combinations of various widths and lengths). In such cases, only the last (and reasonable) dimensions were taken into account. However, it cannot be guaranteed that the last transmitted dimensions (and antenna position) which were further analyzed are the real ones.
- The navigational status of the vessel taken into account during data filtering is normally set manually by OOW. Therefore, due to the presence of human factors, it cannot be ruled out that some erroneous values were obtained. The selection of the same, typical navigational status transmitted via AIS was made to keep the same level of preference resulting from COLREG. Thus, it is possible that in some cases due to OOW's mistake the status should differ and will be taken (or not) to the analysis.
- As there was no link between weather and AIS data, some of the BCR results (so as ships' maneuvers) may be obtained in restricted visibility when other COLREG rules are in force.

All of these limitations or uncertainties listed above have been kept in mind by the authors during the designing of the algorithm for BCR calculation. That is why many data requirements were considered before collecting the final results. Additionally, by utilization of a large set of AIS data (a decade), the statistical measures and spatiotemporal analysis should still be reliable. Potential wrong values should consist only of a small fraction of the entire set of BCRs and should not skew the results of the study and arising findings.

4.2. Future work

Using real AIS traffic data, in a similar manner as in the BCR case, other leading safety indicators related to the ship encounters could be determined. Therefore, further works should be focused, among others,

on the verification of practical distances during evasive maneuver execution. This could be further utilized in the formulation of risk distribution within the existing concept of ship domains [17,56] or critical areas [57,58]. BCR as such may be also further investigated but from different perspectives. For instance, scenarios with various navigational statuses of OS and TS can be verified to incorporate navigators' behavior on give-a-way and stand-on vessels. Also, other COLREG-related actions and circumstances could be analyzed. To these, e.g., passing ahead of other ship's bow in restricted visibility (keeping in mind that Rule 15 only applies in non-restricted visibility) can be included or the impact of other ship movements forcing OS to pass short ahead of TS. To achieve such results, additional (weather- or traffic-related) data should be merged with the spatiotemporal distribution of BCRs. Eventually, ways of incorporating the findings in actual systems, manned or not, shall be investigated.

5. Conclusions

The objectives of this study were focused on verification what are empirical values of BCR (Bow Crossing Range) during routine ship operation, as well as finding what factors impact this indicator and to what extent. To this end, statistical and geospatial analyses were carried out using a large set of real AIS (Automatic Identification System) traffic data and in-house built software. Among considered factors ship type, time of day, dimensions, speed, and type of navigational area (open sea and restricted waters) were taken into account.

The results indicate that BCR reaches different values depending mainly on the type of the vessel and area of her operation. In open waters, the vessel appeared to find around 3.5 NM satisfactory as the number of observations stabilizes at the maximum level. In restricted waters, this value was smaller - around 2.0 NM. Nevertheless, these thresholds are strongly related to the ship type, as significant differences were observed. It was of note, that in encounters where passenger ships were involved, lower BCR values (around 1 NM or even below 0.5 NM) were obtained, especially in restricted waters. On the other hand, analyzing the BCR distribution in terms of day/nighttime did not reveal any additional, strong dependencies and relations between this factor and the bow crossing distance. The differences between the BCRs noted during night and day were practically insignificant (only up to 0.3 – 0.4 NM for encounters with passenger ships engaged). Other factors including ship speed and dimensions also do not impact BCR substantially as a very weak or negligible correlation was found.

The main limitation arises from the utilization of AIS records which typically are burdened with some erroneous data. These were however reduced by multi-stage validation and data filtering to provide reliable results. Future work should be focused on further investigation of empirical BCR including verification of dependencies arising from COLREG (International Regulations for Preventing Collisions at Sea).

The results could be found relevant for fleet managers in preparation of bridge procedures for navigational personnel, as well as for developers of MASS (Maritime Autonomous Surface Ships) collision avoidance solutions. Knowing the patterns of ships' behavior as well as BCR distributions and their dependence on certain factors can help reduce the risk of collision and improve maritime safety.

CRedit authorship contribution statement

Mateusz Gil: Conceptualization, Methodology, Validation, Formal analysis, Investigation, Writing – original draft, Visualization, Writing – review & editing. **Paweł Koziół:** Resources, Data curation, Validation, Visualization. **Krzysztof Wróbel:** Writing – original draft, Project administration, Funding acquisition, Writing – review & editing. **Jakub Montewka:** Writing – review & editing, Funding acquisition.

Declaration of Competing Interest

The authors declare that they have no known competing financial interests or personal relationships that could have appeared to influence the work reported in this paper.

Acknowledgments

The study described has been performed as part of the Detection, prediction, and solutions for safe operations of MASS (ENDURE) project (number NOR/POLNOR/ENDURE/0019/2019–00), supported by the Polish National centre for Research and Development and financed by Research Council of Norway. The authors are grateful to Danish Maritime Authority for making the AIS data available for analysis.

References

- [1] EMSA. Annual overview of marine casualties and incidents 2020. 2020. Lisbon.
- [2] Wróbel K, Montewka J, Kujala P. Towards the assessment of potential impact of unmanned vessels on maritime transportation safety. *Reliab Eng Syst Saf* 2017;165: 155–69. <https://doi.org/10.1016/j.res.2017.03.029>.
- [3] IMO. COLREG: convention on the international regulations for preventing collisions at sea, 1972. International Maritime Organization; 2003.
- [4] Li M, Mou J, Chen L, He Y, Huang Y. A rule-aware time-varying conflict risk measure for MASS considering maritime practice. *Reliab Eng Syst Saf* 2021;215: 107816. <https://doi.org/10.1016/j.res.2021.107816>.
- [5] Chauvin C, Lardjane S. Decision making and strategies in an interaction situation: collision avoidance at sea. *Transp Res Part F: Traffic Psychol Behaviour* 2008;11: 259–69. <https://doi.org/10.1016/j.trf.2008.01.001>.
- [6] Pietrzykowski Z, Wielgosz M. Effective ship domain – Impact of ship size and speed. *Ocean Eng* 2021;219:108423. <https://doi.org/10.1016/j.oceaneng.2020.108423>.
- [7] Sang L, Yan X, Wall A, Wang J, Mao Z. CPA calculation method based on AIS position prediction. *J Navig* 2016;69:1409–26. <https://doi.org/10.1017/S0373463316000229>.
- [8] Bole A, Wall A, Norris A. Radar and ARPA manual: radar, AIS and target tracking for marine radar users. 3rd ed. Oxford: Butterworth-Heinemann; 2014.
- [9] Wawruch R. Comparative study of the accuracy of AIS and ARPA indications. Part 1. Accuracy of the CPA indications. *TransNav, Int J Marine Navigat Saf Sea Transp* 2018;12:439–43. <https://doi.org/10.12716/1001.12.03.02>.
- [10] Zhang W, Goerlandt F, Montewka J, Kujala P. A method for detecting possible near miss ship collisions from AIS data. *Ocean Eng* 2015;107:60–9. <https://doi.org/10.1016/j.oceaneng.2015.07.046>.
- [11] Goerlandt F, Montewka J, Kuzmin V, Kujala P. A risk-informed ship collision alert system: framework and application. *Saf Sci* 2015;77:182–204. <https://doi.org/10.1016/j.ssci.2015.03.015>.
- [12] Vestre A, Bakdi A, Vanem E, Engelhardtens Ø. AIS-based near-collision database generation and analysis of real collision avoidance manoeuvres. *J Navig* 2021: 1–24. <https://doi.org/10.1017/S0373463321000357>.
- [13] Szałczyński R, Krata P, Szałczyńska J. Ship domain applied to determining distances for collision avoidance manoeuvres in give-way situations. *Ocean Eng* 2018;165:43–54. <https://doi.org/10.1016/j.oceaneng.2018.07.041>.
- [14] Wu B, Yip TL, Yan X, Guedes Soares C. Fuzzy logic based approach for ship-bridge collision alert system. *Ocean Eng* 2019;187:106152. <https://doi.org/10.1016/j.oceaneng.2019.106152>.
- [15] IMO. Draft revised imo model course on radar navigation at operational level 2015.
- [16] Cockcroft AN, Lameijer JNF. Guide to the collision avoidance rules - International Regulations for preventing collisions at sea. 7th ed. Oxford: Elsevier; 2012.
- [17] Montewka J, Gil M, Wróbel K. Discussion on the article by Zhang & Meng entitled "Probabilistic ship domain with applications to ship collision risk assessment" [Ocean Eng. 186 (2019) 106130]. *Ocean Eng* 2020;209:107527. <https://doi.org/10.1016/j.oceaneng.2020.107527>.
- [18] Raytheon Marine Company. RAYCAS. Because safety at sea is no accident. *Maritime Rep Eng News* 1980.
- [19] IMO. Resolution MSC.252(83) : Adoption of the Revised Performance Standards for Integrated Navigation Systems (INS) 2007.
- [20] Wróbel K, Gil M, Krata P, Olszewski K, Montewka J. On the use of leading safety indicators in maritime and their feasibility for Maritime Autonomous Surface Ships. In: Proceedings of the Institution of Mechanical Engineers, Part O: Journal of Risk and Reliability; 2021. <https://doi.org/10.1177/1748006X211027689>.
- [21] Yang D, Wu L, Wang S, Jia H, Li KX. How big data enriches maritime research – a critical review of Automatic Identification System (AIS) data applications. *Transp Rev* 2019;39:755–73. <https://doi.org/10.1080/01441647.2019.1649315>.
- [22] Svanberg M, Santén V, Hörteborn A, Holm H, Finnsgård C. AIS in maritime research. *Mar Policy* 2019;106:103520. <https://doi.org/10.1016/j.marpol.2019.103520>.
- [23] van Iperen E. Detection of hazardous encounters at the North Sea from AIS data. In: Proceedings of International Workshop on Next Generation Nautical Traffic Models; 2012. p. 1–12.

- [24] Liu Z, Wu Z, Zheng Z. A novel framework for regional collision risk identification based on AIS data. *Appl Ocean Res* 2019;89:261–72. <https://doi.org/10.1016/j.apor.2019.05.020>.
- [25] Mazurek J, Liu L, Krata P, Montewka J, Krata H, Kujala P. An updated method identifying collision-prone locations for ships. A case study for oil tankers navigating in the Gulf of Finland. *Reliab Eng Syst Saf* 2022;217:108024. <https://doi.org/10.1016/j.ress.2021.108024>.
- [26] Rong H, Teixeira AP, Guedes Soares C. Spatial correlation analysis of near ship collision hotspots with local maritime traffic characteristics. *Reliab Eng Syst Saf* 2021;209:107463. <https://doi.org/10.1016/j.ress.2021.107463>.
- [27] Yoo S-L. Near-miss density map for safe navigation of ships. *Ocean Eng* 2018;163:15–21. <https://doi.org/10.1016/j.oceaneng.2018.05.065>.
- [28] Adland R, Jia H, Lode T, Skontorp J. The value of meteorological data in marine risk assessment. *Reliab Eng Syst Saf* 2021;209:107480. <https://doi.org/10.1016/j.ress.2021.107480>.
- [29] Bye RJ, Aalberg AL. Maritime navigation accidents and risk indicators: an exploratory statistical analysis using AIS data and accident reports. *Reliab Eng Syst Saf* 2018;176:174–86. <https://doi.org/10.1016/j.ress.2018.03.033>.
- [30] Cai M, Zhang J, Zhang D, Yuan X, Soares CG. Collision risk analysis on ferry ships in Jiangsu Section of the Yangtze River based on AIS data. *Reliab Eng Syst Saf* 2021;215:107901. <https://doi.org/10.1016/j.ress.2021.107901>.
- [31] Du L, Goerlandt F, Kujala P. Review and analysis of methods for assessing maritime waterway risk based on non-accident critical events detected from AIS data. *Reliab Eng Syst Saf* 2020;200:106933. <https://doi.org/10.1016/j.ress.2020.106933>.
- [32] Montewka J, Manderbacka T, Ruponen P, Tompuri M, Gil M, Hirdaris S. Accident susceptibility index for a passenger ship—a framework and case study. *Reliab Eng Syst Saf* 2022;218:108145. <https://doi.org/10.1016/j.ress.2021.108145>.
- [33] Zhang M, Montewka J, Manderbacka T, Kujala P, Hirdaris S. A big data analytics method for the evaluation of ship - ship collision risk reflecting Hydrometeorological Conditions. *Reliab Eng Syst Saf* 2021;213:107674. <https://doi.org/10.1016/j.ress.2021.107674>.
- [34] Zhang W, Feng X, Goerlandt F, Liu Q. Towards a convolutional neural network model for classifying regional ship collision risk levels for waterway risk analysis. *Reliab Eng Syst Saf* 2020;204:107127. <https://doi.org/10.1016/j.ress.2020.107127>.
- [35] Altan YC, Otay EN. Spatial mapping of encounter probability in congested waterways using AIS. *Ocean Eng* 2018;164:263–71. <https://doi.org/10.1016/j.oceaneng.2018.06.049>.
- [36] Murray B, Perera LP. An AIS-based deep learning framework for regional ship behavior prediction. *Reliab Eng Syst Saf* 2021;215:107819. <https://doi.org/10.1016/j.ress.2021.107819>.
- [37] Xin X, Liu K, Yang Z, Zhang J, Wu X. A probabilistic risk approach for the collision detection of multi-ships under spatiotemporal movement uncertainty. *Reliab Eng Syst Saf* 2021;215:107772. <https://doi.org/10.1016/j.ress.2021.107772>.
- [38] Du L, Banda OAV, Huang Y, Goerlandt F, Kujala P, Zhang W. An empirical ship domain based on evasive maneuver and perceived collision risk. *Reliab Eng Syst Saf* 2021;213:107752. <https://doi.org/10.1016/j.ress.2021.107752>.
- [39] Hansen MG, Jensen TK, Lehn-Schiøler T, Melchior K, Rasmussen FM, Ennemark F. Empirical ship domain based on AIS data. *J Navig* 2013;66:931–40. <https://doi.org/10.1017/S0373463313000489>.
- [40] Hörteborn A, Ringsberg JW, Svanberg M, Holm H. A revisit of the definition of the ship domain based on AIS analysis. *J Navig* 2019;72:777–94. <https://doi.org/10.1017/S0373463318000978>.
- [41] Winther M, Christensen JH, Plejdrup MS, Ravn ES, Eriksson ÓF, Kristensen HO. Emission inventories for ships in the arctic based on satellite sampled AIS data. *Atmos Environ* 2014;91:1–14. <https://doi.org/10.1016/j.atmosenv.2014.03.006>.
- [42] Yan Z, Xiao Y, Cheng L, Chen S, Zhou X, Ruan X, et al. Analysis of global marine oil trade based on automatic identification system (AIS) data. *J Transp Geogr* 2020;83:102637. <https://doi.org/10.1016/j.jtrangeo.2020.102637>.
- [43] Islam S, Goerlandt F, Feng X, Uddin MJ, Shi Y, Hilliard C. Improving disasters preparedness and response for coastal communities using AIS ship tracking data. *Int J Disaster Risk Reduct* 2020;51:101863. <https://doi.org/10.1016/j.ijdr.2020.101863>.
- [44] Meyers SD, Azevedo L, Luther ME. A Scopus-based bibliometric study of maritime research involving the Automatic Identification System. *Transp Res Interdiscip Perspect* 2021;10:100387. <https://doi.org/10.1016/j.trip.2021.100387>.
- [45] Iphar C, Ray C, Napoli A. Data integrity assessment for maritime anomaly detection. *Expert Syst Appl* 2020;147:113219. <https://doi.org/10.1016/j.eswa.2020.113219>.
- [46] Qu X, Meng Q, Suyi L. Ship collision risk assessment for the Singapore Strait. *Accident Analysis & Prevention* 2011;43:2030–6. <https://doi.org/10.1016/j.aap.2011.05.022>.
- [47] Lensu M, Goerlandt F. Big maritime data for the Baltic Sea with a focus on the winter navigation system. *Mar Policy* 2019;104:53–65. <https://doi.org/10.1016/j.marpol.2019.02.038>.
- [48] Felski A, Jaskólski K, Banyś P. Comprehensive assessment of Automatic Identification System (AIS) data application to anti-collision Manoeuvring. *J Navig* 2015;68:697–717. <https://doi.org/10.1017/S0373463314000897>.
- [49] Wang L, Li Y, Wan Z, Yang Z, Wang T, Guan K, et al. Use of AIS data for performance evaluation of ship traffic with speed control. *Ocean Eng* 2020;204:107259. <https://doi.org/10.1016/j.oceaneng.2020.107259>.
- [50] Eriksson ÓF. AIS status in denmark. In: *Expert Working Group for Mutual Exchange and Deliveries of AIS data 24th Meeting*; 2013.
- [51] Iphar C, Napoli A, Ray C. An expert-based method for the risk assessment of anomalous maritime transportation data. *Appl Ocean Res* 2020;104:102337. <https://doi.org/10.1016/j.apor.2020.102337>.
- [52] Zhao L, Shi G, Yang J. Ship trajectories pre-processing based on AIS data. *J Navig* 2018;71:1210–30. <https://doi.org/10.1017/S0373463318000188>.
- [53] Yang D, Wu L, Wang S. Can we trust the AIS destination port information for bulk ships?—Implications for shipping policy and practice. *Transp Res Part E: Logistic Transport Rev* 2021;149:102308. <https://doi.org/10.1016/j.tre.2021.102308>.
- [54] Met Office. Cartopy: a cartographic python library with a Matplotlib interface 2010.
- [55] Virtanen P, Gommers R, Oliphant TE, Haberland M, Reddy T, Cournapeau D, et al. SciPy 1.0: fundamental algorithms for scientific computing in Python. *Nat Methods* 2020;17:261–72. <https://doi.org/10.1038/s41592-019-0686-2>.
- [56] Zhang L, Meng Q. Probabilistic ship domain with applications to ship collision risk assessment. *Ocean Eng* 2019;186:106130. <https://doi.org/10.1016/j.oceaneng.2019.106130>.
- [57] Gil M, Montewka J, Krata P, Hinz T, Hirdaris S. Determination of the dynamic critical maneuvering area in an encounter between two vessels: operation with negligible environmental disruption. *Ocean Eng* 2020;213:107709. <https://doi.org/10.1016/j.oceaneng.2020.107709>.
- [58] Gil M. A concept of critical safety area applicable for an obstacle-avoidance process for manned and autonomous ships. *Reliab Eng Syst Saf* 2021;214:107806. <https://doi.org/10.1016/j.ress.2021.107806>.