

Case Report

Voltage Profiles Improvement in a Power Network with PV Energy Sources—Results of a Voltage Regulator Implementation

Agata Szultka ¹, Seweryn Szultka ^{2,*} , Stanisław Czapp ² , Robert Karolak ¹, Marcin Andrzejewski ¹, Jacek Kapitaniak ¹, Marcin Kulling ¹ and Jan Bonk ¹

¹ Energa-Operator SA, Marynarki Polskiej 130, 80-557 Gdańsk, Poland; agata.szultka@energa-operator.pl (A.S.); robert.karolak@energa-operator.pl (R.K.); marcin.andrzejewski@energa-operator.pl (M.A.); jacek.kapitaniak2@energa-operator.pl (J.K.); marcin.kulling@energa-operator.pl (M.K.); jan.bonk@energa-operator.pl (J.B.)

² Faculty of Electrical and Control Engineering, Gdańsk University of Technology, 80-233 Gdańsk, Poland; stanislaw.czapp@pg.edu.pl

* Correspondence: seweryn.szultka@pg.edu.pl

Abstract: The constant increase in the number of photovoltaic (PV) energy sources in distribution networks is the cause of serious voltage problems. The networks built at least a dozen years ago are not provided for the installation of a large number of micro-sources. It happens that the previously properly functioning power networks are not able to provide to consumers power with the required parameters, after installing many PV sources. The problem relates especially to the level of voltage in the networks. This phenomenon sometimes occurs on sunny days, especially in summer. This paper discusses the use of a Low-Voltage Regulator (LVR-sys) in a selected rural distribution network with PV micro-sources. Measured voltage levels in this network, before application and after application of this regulator, are presented. The application of the regulator significantly improved voltage levels in the network and enabled these levels to be maintained within the normative range.

Keywords: low-voltage network; photovoltaic systems; voltage control; voltage regulator



Citation: Szultka, A.; Szultka, S.; Czapp, S.; Karolak, R.; Andrzejewski, M.; Kapitaniak, J.; Kulling, M.; Bonk, J. Voltage Profiles Improvement in a Power Network with PV Energy Sources—Results of a Voltage Regulator Implementation. *Energies* **2022**, *15*, 723. <https://doi.org/10.3390/en15030723>

Academic Editors: Alon Kuperman and Andrea Bonfiglio

Received: 13 December 2021

Accepted: 17 January 2022

Published: 19 January 2022

Publisher's Note: MDPI stays neutral with regard to jurisdictional claims in published maps and institutional affiliations.



Copyright: © 2022 by the authors. Licensee MDPI, Basel, Switzerland. This article is an open access article distributed under the terms and conditions of the Creative Commons Attribution (CC BY) license (<https://creativecommons.org/licenses/by/4.0/>).

1. Introduction

In recent years, there has been a noticeable increase in the number of photovoltaic (PV) installations. In low-voltage networks, a large share of micro-installations (up to 50 kW) at customers is visible. The networks that have been designed and built so far do not take into account power production, but only consumption. The design calculations performed for these networks were related to voltage drops, line load, and the effectiveness of electric shock protection only for power consumption cases. Design calculations related to the possible voltage increase as a result of connecting power sources to the grid are still not performed. According to the national legal regulation [1] and standard EN 50160 [2], the permissible range of the network voltage is $(0.9\text{--}1.1) V_n$, where V_n is the nominal voltage of the network. Due to the emerging voltage problems in the low-voltage network, it is possible to reconfigure the network. Such a proposal appeared in the publication [3]. However, this solution can only be used for urban networks, where the power infrastructure is extensive and it is possible to transfer network divisions. Unfortunately, such a solution is not effective in rural areas. Another way is to replace the existing power line by a line with a greater cross-section of conductors, as presented in the article [4]. However, this solution is associated with the costs of rebuilding the network and also takes a relatively long time to implement. Another solution is the use of the Local Active Power Curtailment (APC); such an example was presented in the article [5]. Unfortunately, this solution requires limiting the power produced by PV sources, which is not beneficial for prosumers.

In addition to rebuilding or changing the network configuration, it is possible to use the following solutions/devices that are designed to improve the voltage level in the network:

- The On-Load Tap Changer (OLTC) is able to change the voltage in the supplying power substation. In the paper [6], power fluctuations, and thus voltage variations, were limited by means of an OLTC. It was also shown in the article [7] that if there is an OLTC in the distribution network, it is not necessary to control the reactive power of PV inverters. The disadvantage of this solution could be a limited number of switchings, but the current solutions allow for a high number of them [8]. However, it is not always possible to use an OLTC; an example may be a grid in which PV sources are present in only one circuit. In such a case, global voltage regulation at the power substation level could improve power quality in one circuit but degrade in others. Another disadvantage could be inability to mitigate the three-phase unbalance.
- Some publications [9–11] considered the use of energy storage devices in order to optimize power flows and thus influence the voltage level in the network. The weak point of this solution is a relatively high cost of the devices, and their durability is not long.
- The Static VAR Compensator (SVC) is an electronic device that controls the voltage level by providing reactive power in the node. Commonly, it consists of a coupling transformer, thyristor valves, reactors, and capacitors. This device can inject reactive shunt compensation for a dynamic voltage control. If the voltage level in the node with a SVC is constant, the SVC should vary the reactive power in the node [12]. However, the low-voltage networks are characterized by a high R/X ratio, so the reactive power impact on the voltage level is not sufficient [13].
- The Distribution Static Synchronous Compensator (D-STATCOM) is a static compensator, which is re-adapted for distribution systems. It consists of energy storage devices, an AC filter, a three-phase inverter, and a coupling transformer for the shunt connection with the distribution network [14]. Unfortunately, the cost of the device is high, and it is related to storage devices.
- In the Power Factor Control (PFC) solution, the reactive power control is performed by the PV inverters [15]. It is possible to install devices that can control the reactive power in the node with PV sources. In the article [16], a Distributed μ -STATCOM was presented, which controls the reactive power flow in the node with PV sources. However, this solution is based on the voltage control by the reactive power, which, in low-voltage networks, is ineffective.
- The publication [17] proposed a Dynamic Voltage Restorer (DVR). This device can control the voltage level by two-level step regulation (large and small step). It can also be designed with a small energy storage unit or energy sources in order to obtain operation in a continuous way.
- The Step-Voltage Regulator (SVR) is based on an autotransformer, connected in series with the power network, with multiple taps and a servomechanism that allows the selection of the most appropriate output voltage level by mechanically changing the winding coupling [18]. In addition, by this device, the voltage asymmetry can be reduced [19]. In the publication [20], the SVR was used for the asymmetry reduction in a medium-voltage network. A very similar device, which is also connected to the network in series, is an Active Voltage Regulation Transformer (AVRT), presented in the paper [21].
- Despite the above-mentioned devices being able to work separately, there are some publications where the cooperation of those devices for additional advantages is presented. In the article [22], a central regulation for devices such OLTC, SVR, and PV inverters was discussed. In the publication [23], the cooperation of an SVC device with distributed sources was proposed. In the paper [24], several SVR devices operated in cascade and, in this case, it was necessary to apply central regulation.



This paper presents problems of the voltage profiles in a real low-voltage network (230/400 V) with PV energy sources, located in northern Poland, and the results of the experiment–verification of voltage levels improvement after the application of a Low-Voltage Regulator (marked by the authors as LVR-sys) to this network. These levels were measured in the real low-voltage network, before and after installation of the LVR-sys. Thus far, the well-working low-voltage network has voltage problems when it has been saturated with PV sources. This saturation of PV sources makes the voltage exceed the upper permissible limit ($1.1 V_n$) in some periods of the year. This has been found during the measurements carried out along the main line of the network (not at the consumer’s origin of the electrical installation). The main aim of the experiment is to verify if the applied LVR-sys is able to maintain the voltage within the normative range ($0.9\text{--}1.1 V_n$).

The rest of this paper is organized as follows. In Section 2, descriptions of the LVR-sys regulator and the real low-voltage network are presented. Section 3 includes results of the measurements of voltage profiles and power flow in the analyzed power network. Conclusions following from the experiment are included in Section 4.

2. Materials and Methods

2.1. Description of the LVR-sys Regulator

The operation of the LVR-sys regulator (manufacturer: *a-eberle*, distributor: *ASTAT*) is similar to the operation of a transformer with on-load tap control. The basis for the application of this solution is the need to maintain the required voltage level of the distribution network and to improve the power quality parameters, which are influenced by the connected distributed generation sources [25]. The main regulated variable is the voltage (in each phase) at the secondary side of the LVR-sys regulator. The device specifies the voltage values that should be maintained at the regulator output, taking into account the dead band. If the values of the measured voltages at the output of the device exceed the permissible limit, the operation of the regulator/controller takes place. The device responds after a certain time delay, which is defined by selecting the appropriate characteristics. Moreover, after activating the function ‘Grid impedance’, new control values are generated. Measurement of the currents and parameterization of the network impedance enable for precise calculation of the voltage in a given node (even far from the output terminals of the device). This allows the regulation to be optimized without the use of network communication devices.

The analyzed regulator provides independent voltage regulation in each phase by connecting two series transformers with thyristors. The transformers are controlled by thyristors. The semiconductor elements are characterized by a high durability and ease of use, as well as a low short-circuit resistance. The stages of transformer operation are determined by the thyristor switching settings. Table 1 shows the possible steps of the voltage regulation. The device allows the voltage to be adjusted in 9 steps.

Table 1. Generated voltage steps using thyristors; data according to [26].

Step	Transformer 1.5%	Transformer 4.5%
−6.0%	−1.5%	−4.5%
−4.5%	0	−4.5%
−3.0%	+1.5%	−4.5%
−1.5%	−1.5%	0
0%	0	0
+1.5%	+1.5%	0
+3.0%	−1.5%	+4.5%
+4.5%	0	+4.5%
+6.0%	+1.5%	+4.5%

Thyristor control signals are generated in circuits ensuring their intelligent switching. Taking into account the participation of the magnetic field in the transformer and related phenomena, the application of the LVR-sys system can have a positive effect on the shape and parameters of the load current and level of the controlled voltage. As each phase can be controlled separately, it also becomes possible to reduce voltage unbalance.

Figure 1a shows the structure of the LVR-sys regulator, and Figure 1b shows an example of voltage regulation by +3%, whereas Figure 1c depicts a view of the tested LVR-sys regulator.

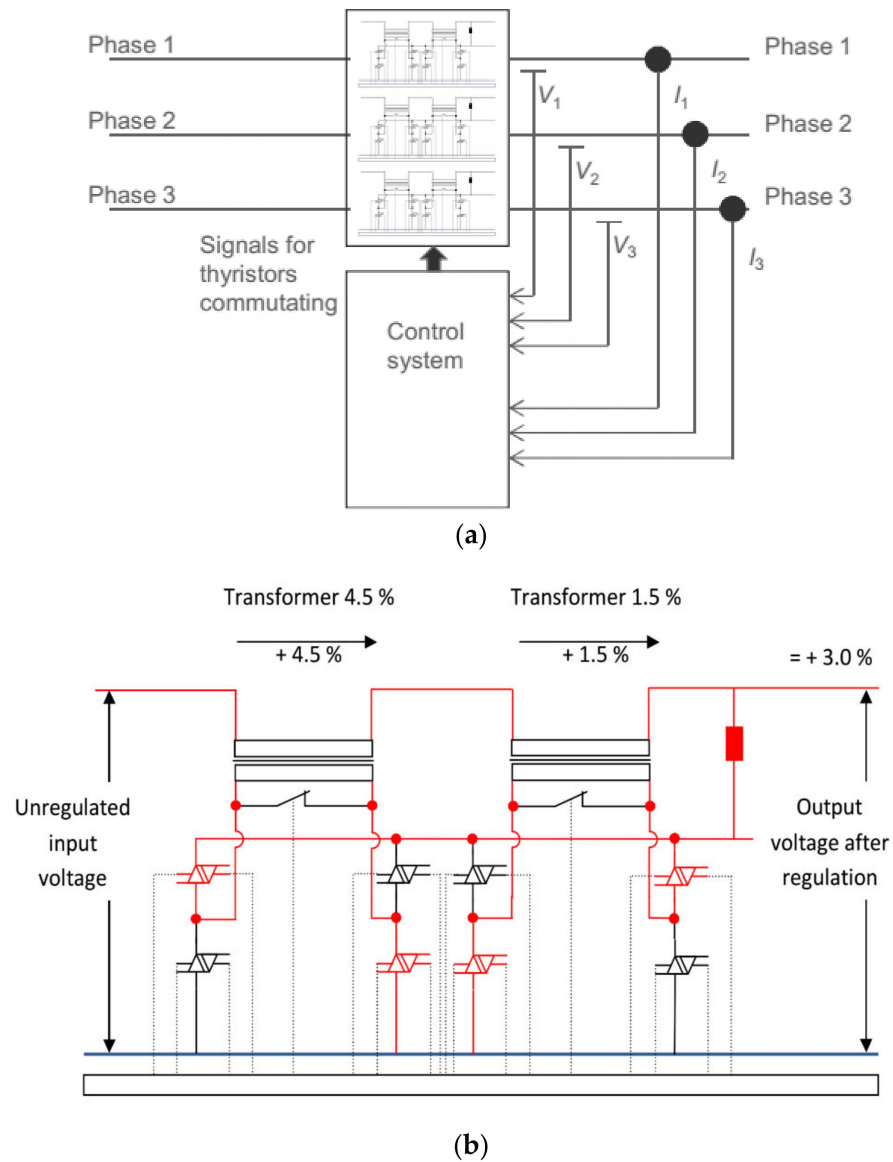

Figure 1. Cont.

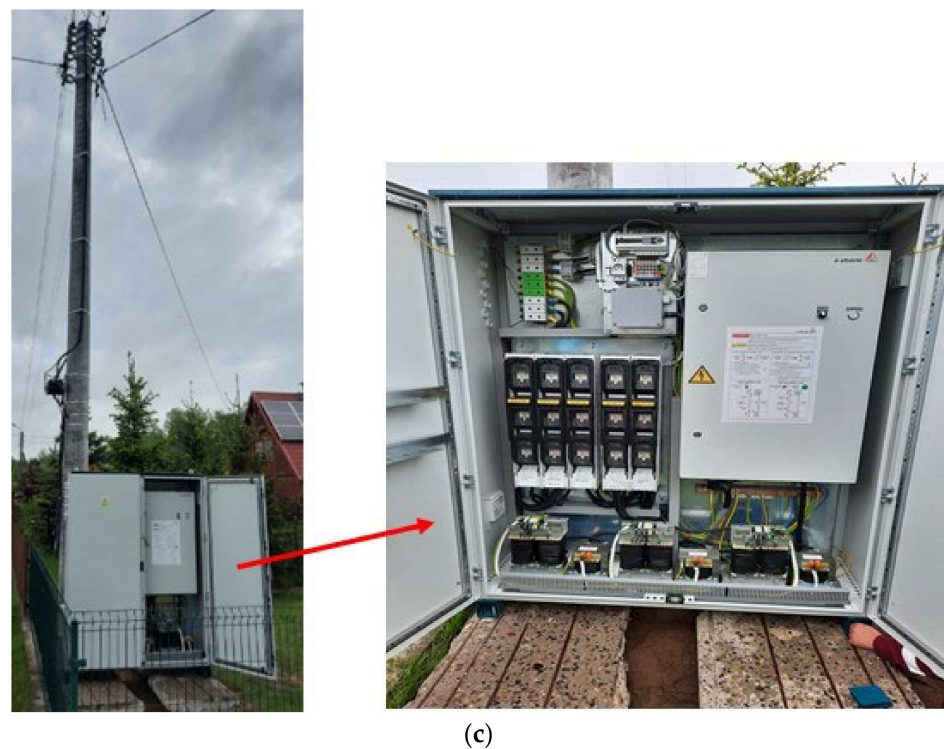

Figure 1. The structure of the LVR-sys regulator (a), example of voltage regulation by +3%, according to [26] (b), and a view of the tested LVR-sys (c).

The device is installed in series in the low-voltage network. The place of installation of the LVR-sys in the low-voltage network can be arbitrary. It is possible to install the device at the power transformer substation, as well as in the interior of the network in any place. It can be installed outdoors because it has a special enclosure. It should be placed on a special foundation or plates. Selected parameters of the device used for the tests are presented in Table 2.

Table 2. Selected parameters of the LVR-sys device; data according to [26].

Parameter	Value
Power	144 kVA
Regulation area	+/-6%
Rated voltage	400 V
Rated current	200 A
Rated frequency	50 Hz
Degree of protection	IP 54
Type of electrical system	TN-C

2.2. Description of the Analyzed Network

The analyzed power network consists of two circuits: circuit '100' and circuit '200'. Circuit '100' is an overhead rural network in which the main supply line is $4 \times \text{AL } 25$ (four-wire, aluminum bare conductors of nominal cross-sectional area 25 mm^2). The main supply line of circuit '200' is made up of $\text{AsXS}_{\text{n}} 4 \times 70$ (four-wire, insulated aluminum conductors of nominal cross-sectional area 70 mm^2). In both cases, the loads are single-family houses, and summer or agricultural houses. Circuit '100' is saturated with PV sources (7 installations with a total power of approx. 30 kW); in circuit '200', there is 1 PV installation. As a result of the injected power produced by the PV sources in the network, voltage problems arise in circuit '100'—too high an rms value of the supply voltage occurs. Customers of circuit '100' complain about inadequate voltage parameters in the network.



There are no voltage problems in circuit '200'. Therefore, the considerations in this article refer only to circuit '100'. The structure of the analyzed network is shown in Figure 2.

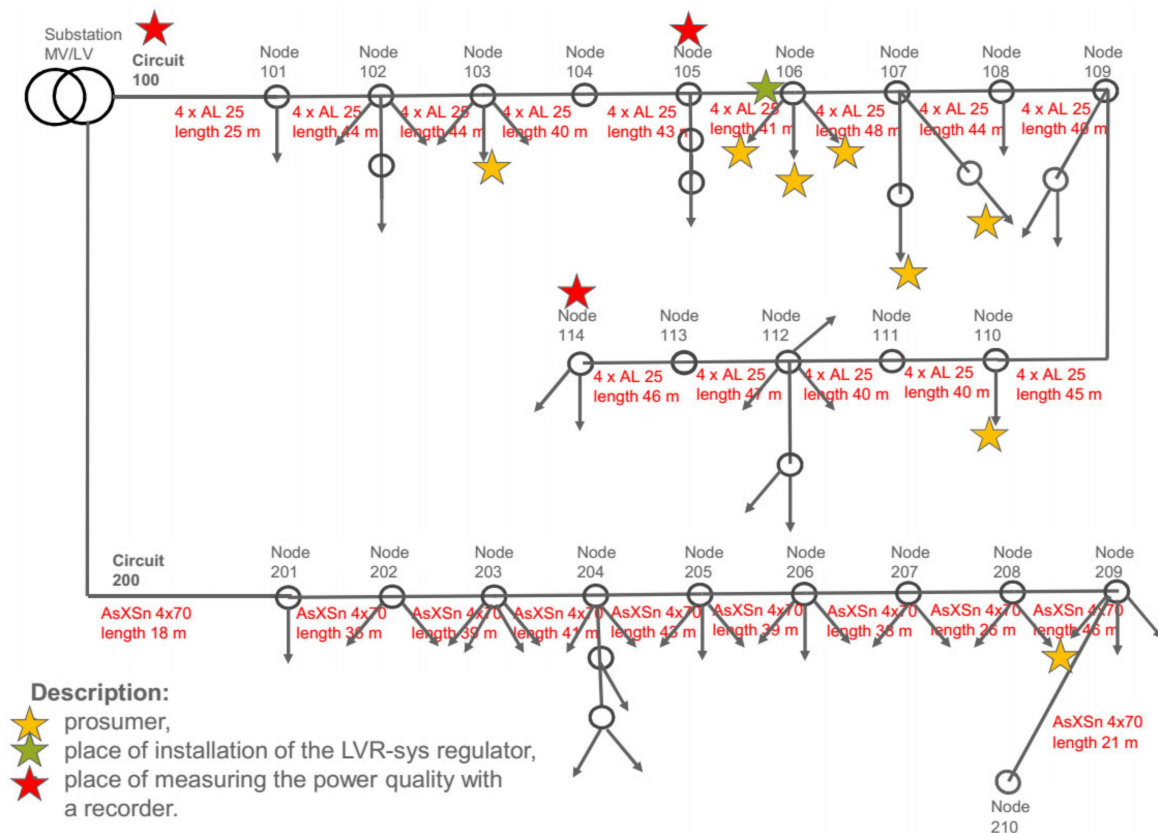

Figure 2. Structure of the analyzed low-voltage network for circuits '100' and '200,' as well as information about the location of the photovoltaic sources, the places where the measurements were made with a recorder, and the node where the LVR-sys is installed.

The '100' circuit of the analyzed network is characterized as follows:

- The voltage at the power substation is within range: $235 \div 247$ V (before the LVR-sys implementation).
- The voltage in the power substation is set slightly higher than the nominal value due to the relatively high length of circuit '100' (14 nodes) and the low cross-section of the wires ($4 \times \text{Al } 25$), and there is a high voltage drop on circuit '100'.
- In the absence of PV sources, the voltage in the network was correct; the average rms voltage from 10 min measurements did not fall below the lower limit value of $0.9 V_n$, i.e., 207 V, at the final node 114.
- In the case of power generation by PV sources, the voltage value sometimes (especially in sunny summer days) increases beyond the permissible upper limit of $1.1 V_n$, i.e., 253 V, in the low-voltage network. This has been confirmed by measurements carried out deep inside in the network and not directly at the consumer's origin of the electrical installation.
- The voltage reduction on the transformer substation is not possible, because, during peak load (approx. 6 a.m.), when there is no power generation by the PV sources, the voltage at the end of the circuit would be too low.
- The power network requires reconstruction (cable cross-section 25 mm^2); when replacing cables with cables with a larger cross-section, one should expect an improvement in the voltage situation in the network. Nevertheless, such an investment takes time. For this reason, the possibility of using the LVR-sys voltage regulator as a temporary solution, pending the modernization of the line, was tested.

2.3. Description of the Experiment

In order to carry out the experiment, recorders with the measurement accuracy class 'A' were used. They were installed in the following places (places of installation are shown in Figure 2):

- In the supply substation in the '100' circuit, this location is marked as 'A' and the results of the measurements are marked as (V_A, P_A) .
- In the node upstream of the LVR-sys regulator, in Figure 2, it is node no. 105; this location is marked as 'B' and the results of the measurements are marked as (V_B, P_B) .
- In the node farthest from the supply substation, in Figure 2, it is node no. 114; this location is marked as 'C' and the results of the measurements are marked as (V_C, P_C) .

In addition, the regulator/controller output parameters were also measured by the controller itself. The results of the measurements at the output terminals of the LVR-sys are marked as the results from place 'D' (V_D, P_D) .

In order to obtain greater readability of the results, the graphs of voltage variation in the selected nodes in the network are presented for specific days. In the case of no LVR-sys device in the network, a sunny day was selected: 20 May 2021 (Thursday); in the case of network operation with the device, it was also a sunny day: 11 June 2021 (Friday). In addition, the voltage (V_D) and power diagrams (P_D, Q_D) at the regulator output for the entire test period were presented, i.e., from 1 June 2021 to 29 June 2021. The value of the set voltage V_{ref} at the output of the LVR-sys regulator was, respectively: on 1 June 2021 to 24 June 2021: $V_{ref} = 230$ V (nominal voltage of the network); on 24 June 2021 to 29 June 2021: $V_{ref} = 240$ V.

3. Results

3.1. Case A: Without Regulator LVR-sys in the Network

Figures 3–5 present variations in the voltage and active power in selected nodes, before installation of the LVR-sys regulator. If the node is located relatively close to the supply transformer substation, voltage variations are small. In the supply substation node, the voltage varies within the range $V_A = (235 \div 247)$ V; in node 105, $V_B = (222 \div 255.9)$ V. Node 114 (Figure 5) has the worst voltage conditions $V_C = (207.6 \div 262)$ V.

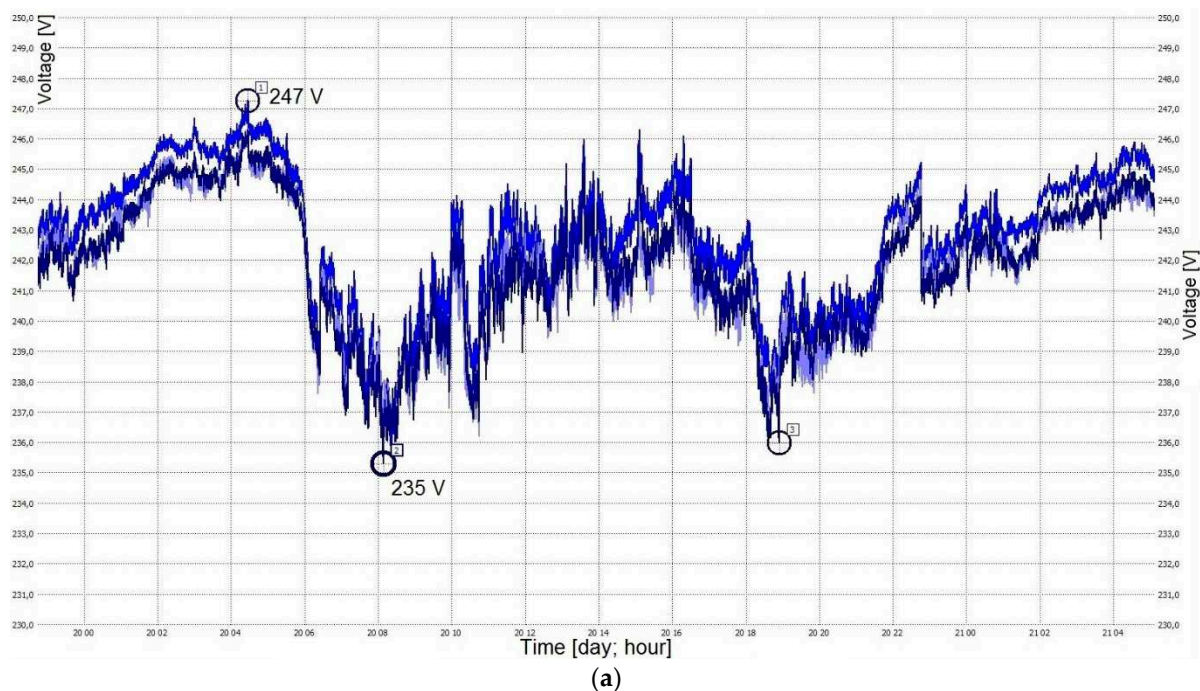

Figure 3. Cont.

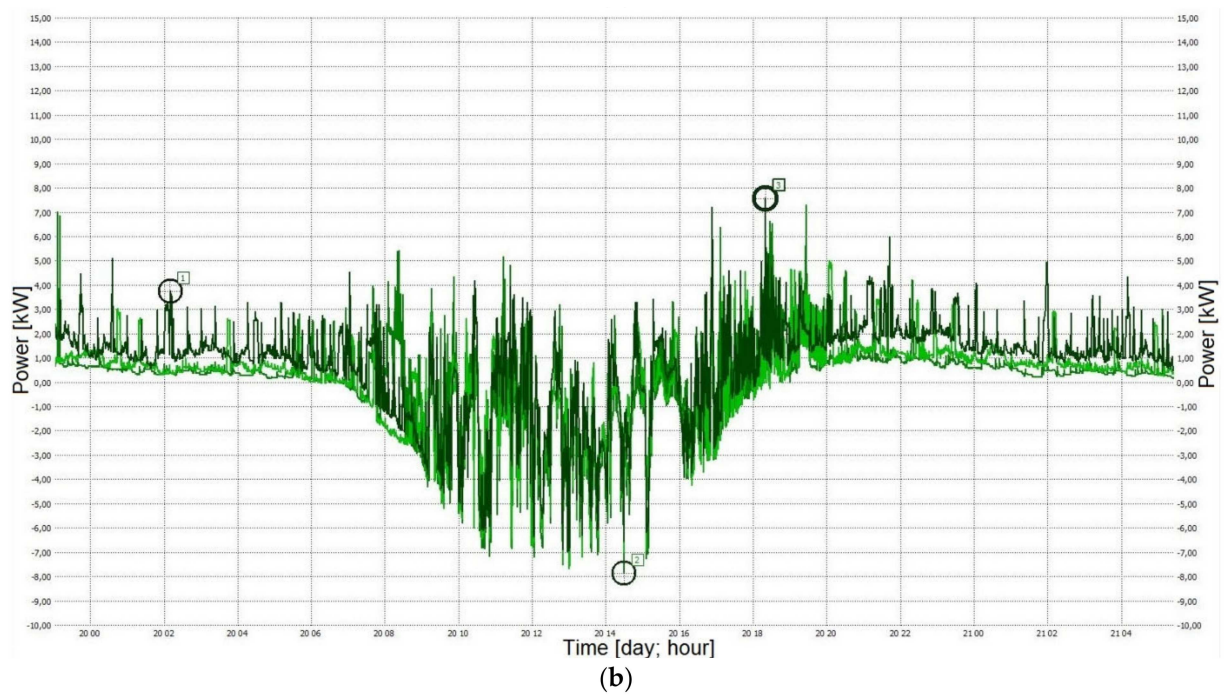

Figure 3. Voltage and active power variations in the supply substation (period: 20 May 2021, hour 2:00 a.m.–21 May 2021, hour 4:00 a.m.): (a) voltage V_A ; (b) active power P_A .

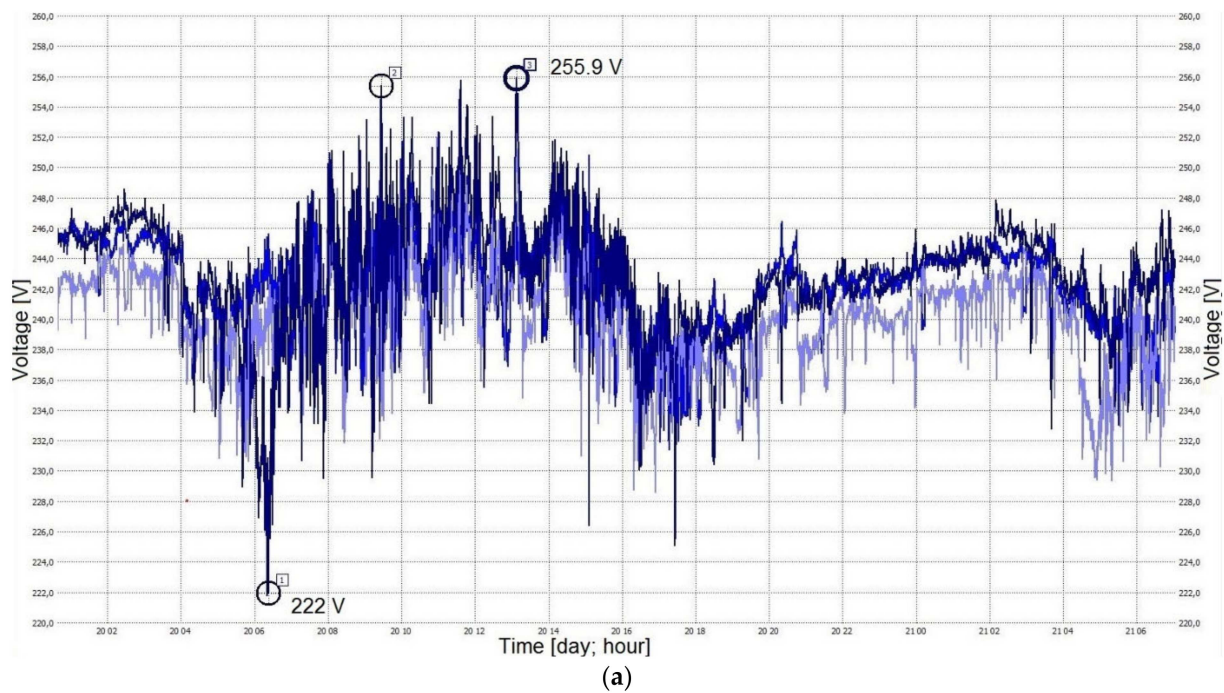

Figure 4. Cont.

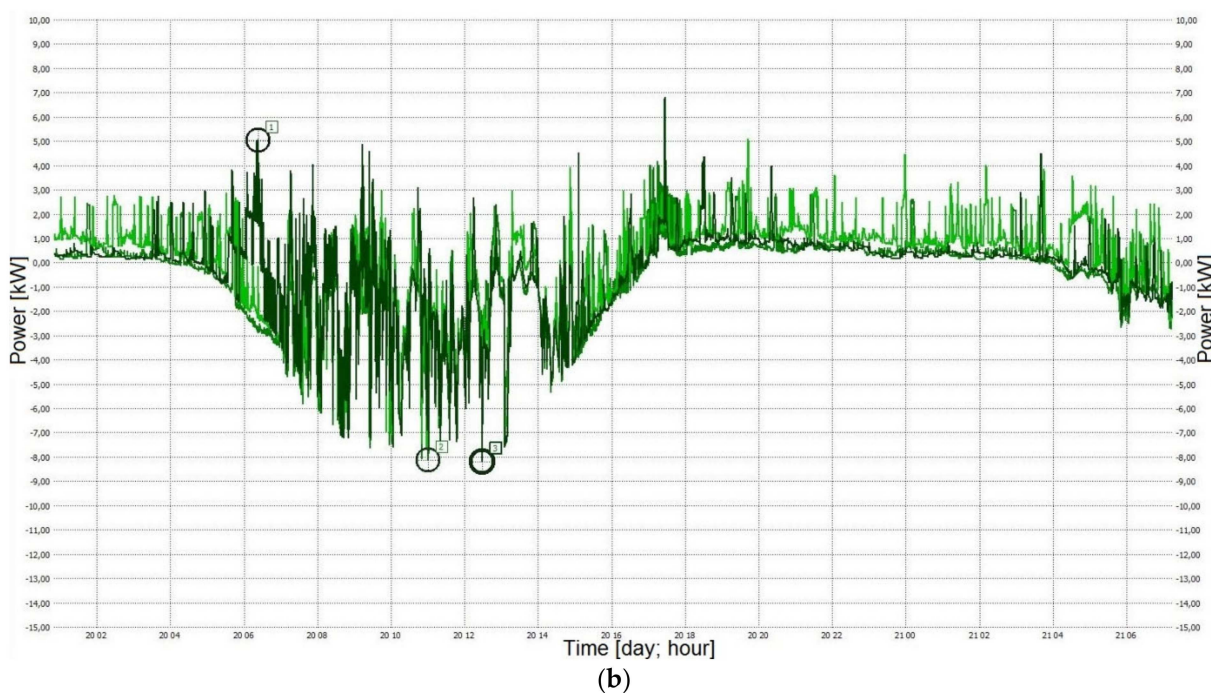

Figure 4. Voltage and active power variations in node 105 (period: 20 May 2021, hour 2:00 a.m.–21 May 2021, hour 4:00 a.m.): (a) voltage V_B ; (b) active power P_B .

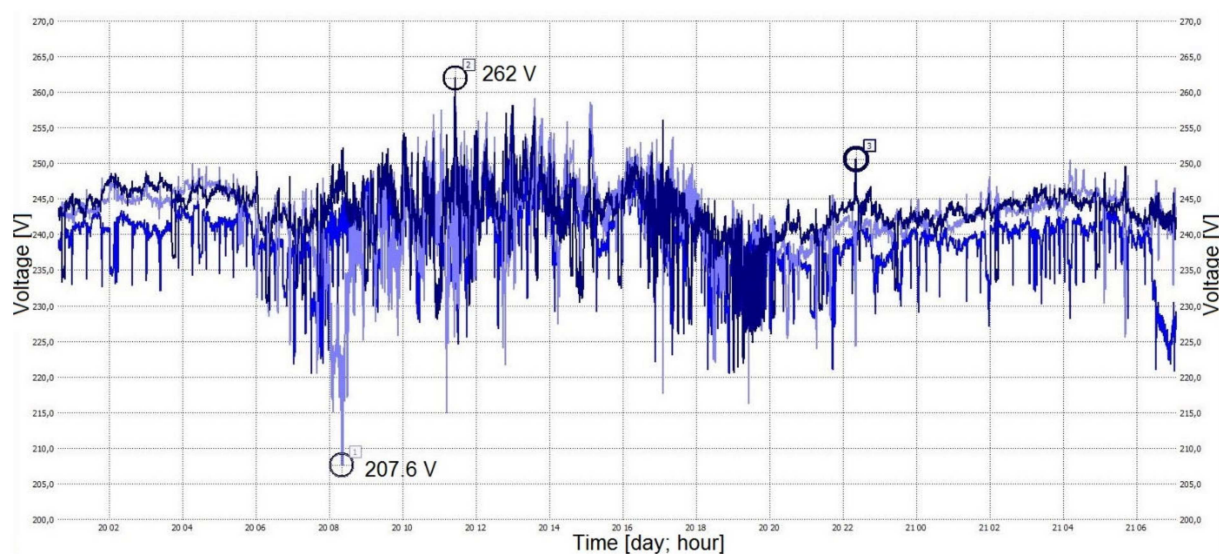

Figure 5. Voltage variations V_C in node 114 (period: 20 May 2021, hour 2:00 a.m.–21 May 2021, hour 4:00 a.m.).

3.2. Case B: With Regulator LVR-sys in the Network

Figures 6–8 present variations in the voltage and active power in selected nodes, after installation of the LVR-sys regulator. The voltages vary within the following ranges:

- $V_A = (235.3 \div 246.8) \text{ V}$;
- $V_B = (226 \div 256.4) \text{ V}$;
- $V_C = (213 \div 247) \text{ V}$.

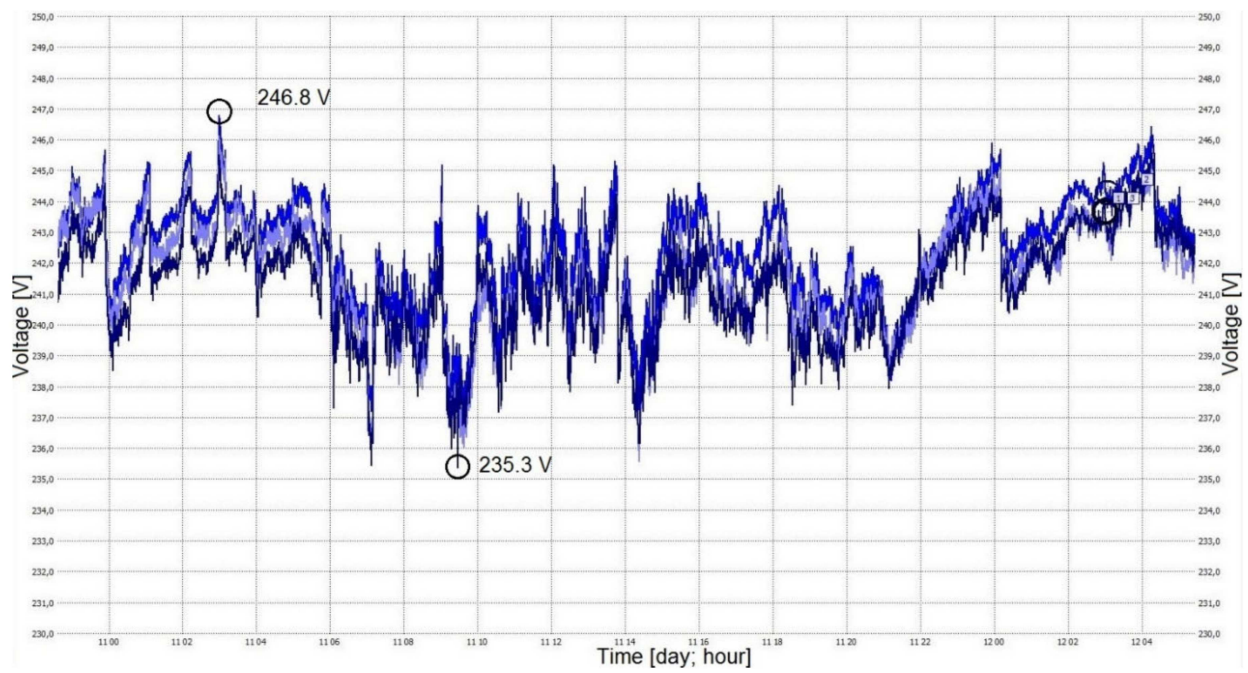

Figure 6. Voltage variations V_A in the supply substation (period: 11 June 2021, hour 0:00 a.m.–12 June 2021, hour 4:00 a.m.).

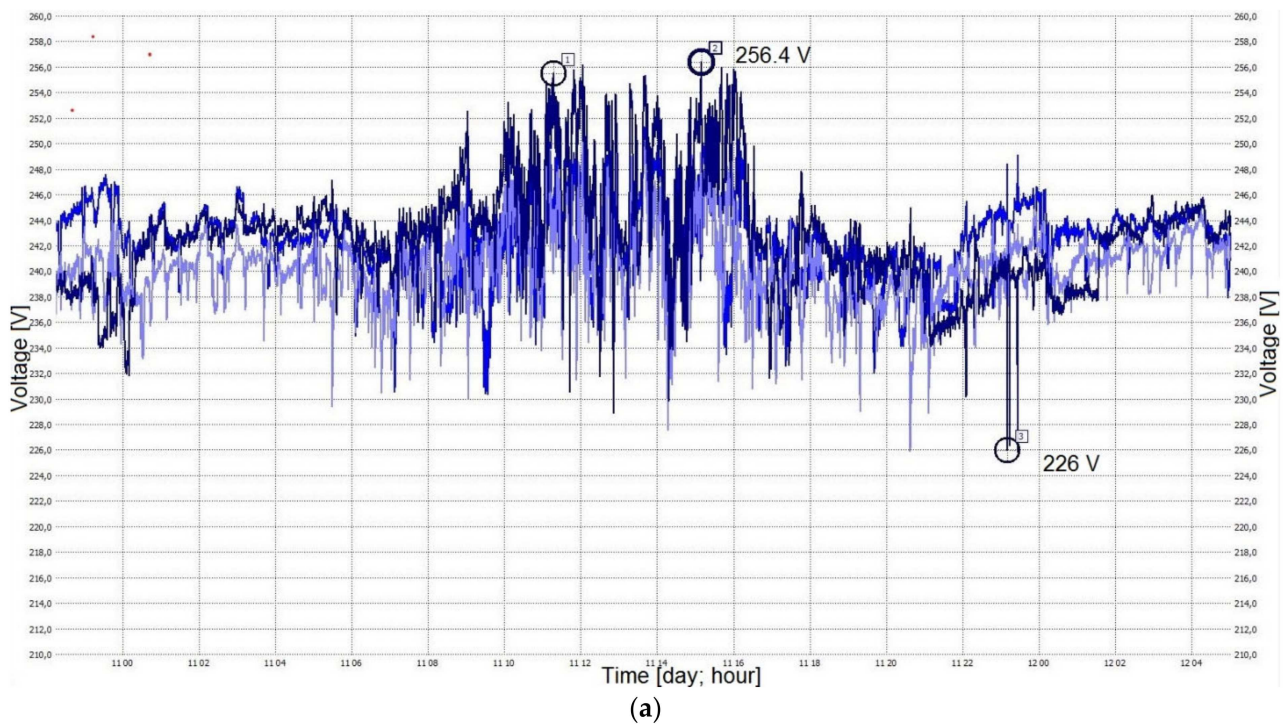

Figure 7. Cont.

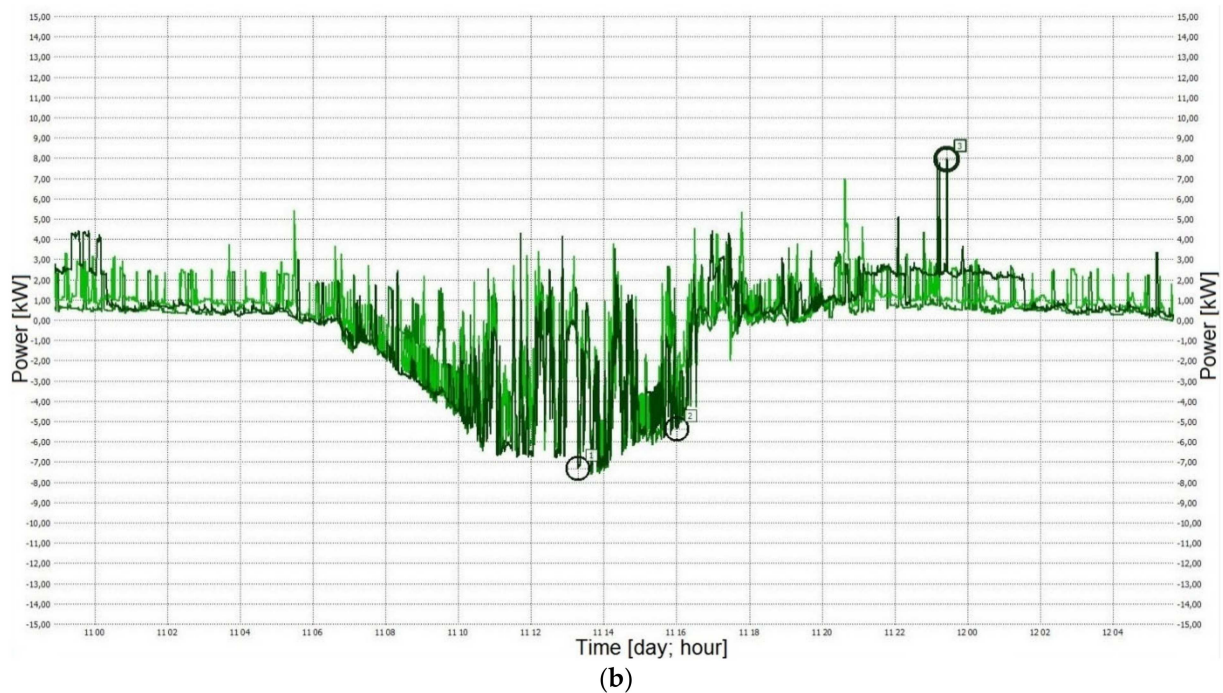

Figure 7. Voltage and active power variations in node 105 (period: 11 June 2021, hour 0:00 a.m. – 12 June 2021, hour 4:00 a.m.): (a) voltage V_B ; (b) active power P_B .

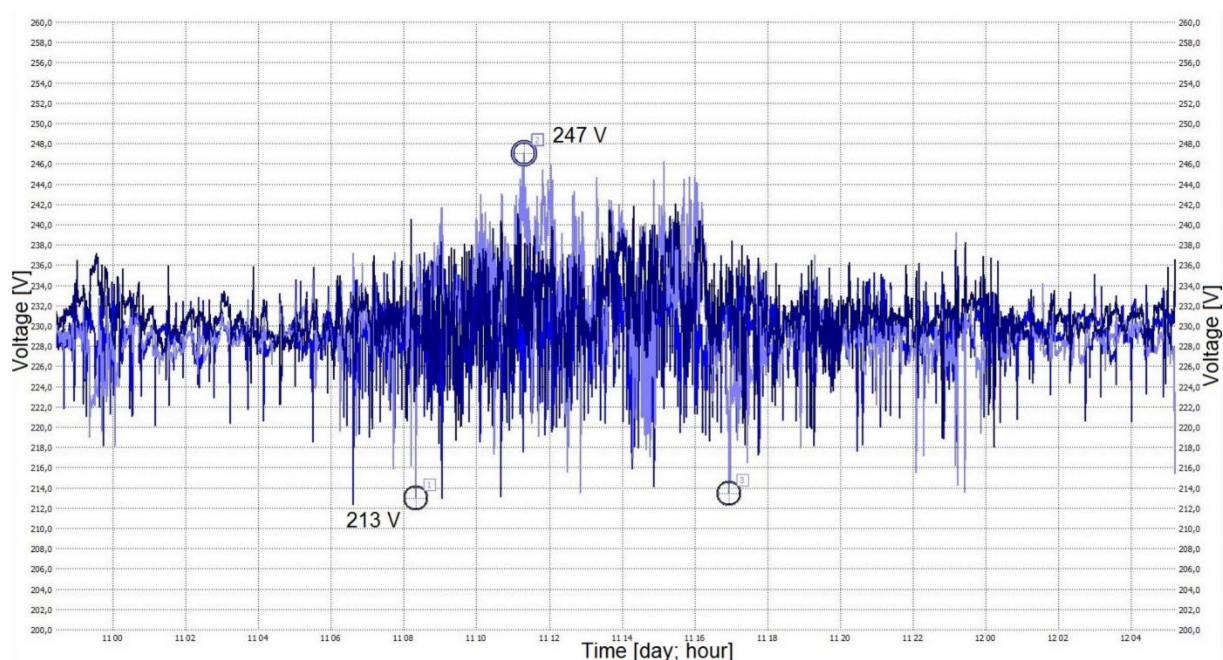

Figure 8. Voltage variations V_C in node 114 (period: 11 June 2021, hour 0:00 a.m. – 12 June 2021, hour 4:00 a.m.).

Figure 9 presents voltage variations at the LVR-sys output terminal for the entire test period.

The presented results of the measurements (Figures 6–8) show that the voltage variability has decreased with reference to the case without the LVR-sys, which has allowed the parameters of the power quality to be improved. Unfortunately, the voltage at the input of the device did not improve; this is related to the fact that the power produced by the PV sources in node 105 did not change—it was approx. 8 kW per phase (from the comparison of Figures 4b and 7b).

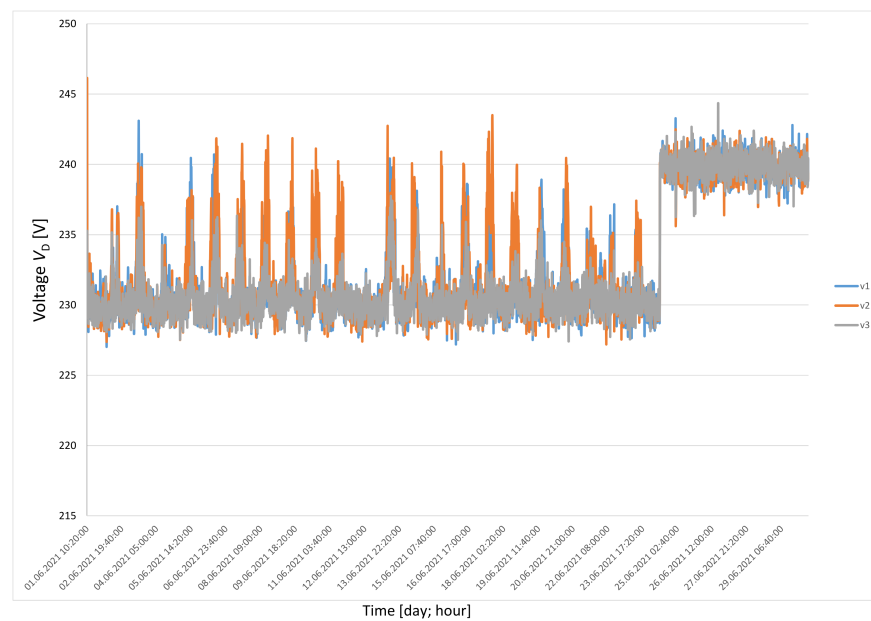

Figure 9. Voltage variations V_D for three phases (v_1 , v_2 , v_3); period: 1 June 2021, hour 10:20 a.m. – 29 June 2021, hour 6:40 a.m.

Figure 9 shows that the LVR-sys was not able to maintain the set value at the 230 V output, which is related to the fact that the device has control possibilities that are too low—the range of ± 6 V is not sufficient in the case of the analyzed network. After changing the set voltage $V_{ref} = 240$ V on 24 June 2021, a smaller voltage variation around the set value is visible (Figure 9). It is a positive effect. The power flow presented in Figure 10 shows that the rated power of the LVR-sys device could be significantly lower than 140 kVA (the power flow does not exceed 20 kW).

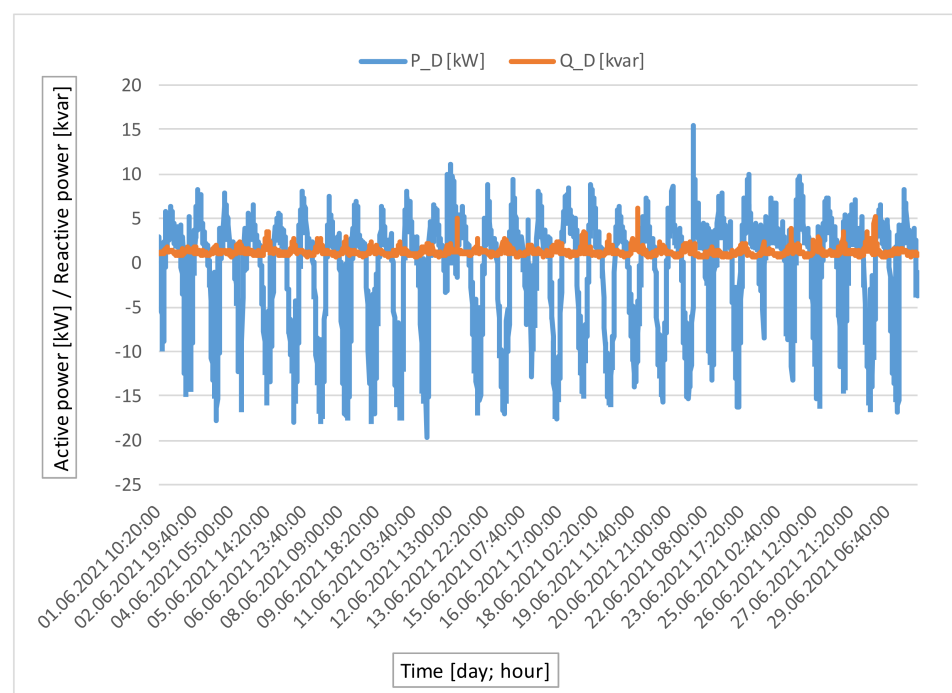

Figure 10. Active P_D and reactive Q_D power variations; period: 1 June 2021, hour 10:20 a.m. – 29 June 2021, hour 6:40 a.m.

4. Conclusions

In power networks with PV sources, there are more technical problems, especially with voltage profiles, than in networks without these sources. Moreover, the number of voltage regulation methods are limited in low-voltage networks. The paper presents a case report of the use of an additional device in a rural low-voltage network to improve the parameters of the power quality. The study was conducted on a real low-voltage network with PV micro-sources. After the analysis, the following conclusions were formulated:

- The regulator LVR-sys improved the voltage levels in the network.
- The voltage at the farthest node no. 114 after installing the regulator was within the normative range, i.e., (207 ÷ 253 V). The recorded values were (207.6 ÷ 262) V before LVR-sys implementation, and (213 ÷ 247) V after LVR-sys implementation.
- The device increased the voltage regulation possibilities in the network.
- It is important to be able to set the voltage at the output of the regulator, thanks to which it is possible to limit the range of voltage variation and to adjust the voltage value to the individual needs of the network.
- Due to the fact that the power produced by PV sources did not change (approx. 8 kW per phase), after installation of the LVR-sys, the voltage at the input of the LVR-sys also remained unchanged.
- A device of this type can effectively support power system operators in preventing voltage problems in the most difficult cases (until the major reconstruction of the low-voltage network in a given area is completed).

Author Contributions: Conceptualization, A.S. and M.K.; methodology, A.S., R.K., J.K., M.A., M.K. and J.B.; validation, A.S.; formal analysis, A.S. and S.S.; investigation, A.S., R.K., M.A., J.K., M.K. and J.B.; resources, A.S. and S.S.; writing—original draft preparation, A.S., S.S. and S.C.; writing—review and editing, A.S., S.S. and S.C.; supervision, S.C. All authors have read and agreed to the published version of the manuscript.

Funding: This research received no external funding.

Institutional Review Board Statement: Not applicable.

Informed Consent Statement: Not applicable.

Data Availability Statement: Data is contained within the article.

Conflicts of Interest: The authors declare no conflict of interest.

References

1. Regulation of the Minister of Economy of 4 May 2007 on the Detailed Conditions for the Operation of the Power System (Dz.U. z 2007, Nr 93, Poz. 623, in Polish). Available online: <http://Isap.Sejm.Gov.Pl/Isap.Nsf/DocDetails.Xsp?Id=wdu20070930623> (accessed on 14 May 2021).
2. CENELEC (European Committee for Electrotechnical Standardization). *EN 50160:2010; Voltage Characteristics of Electricity Supplied by Public Electricity Networks*; European Committee for Electrotechnical Standardization: Brussels, Belgium, 2010.
3. Pijarski, P.; Jędrychowski, R.; Adamek, S.; Miller, P. Optimization of the Selection of Power Supply Points for Buildings Equipped with PV Installations in Urban Areas. In Proceedings of the 2019 Progress in Applied Electrical Engineering (PAEE), Koscielisko, Poland, 17–21 June 2019; pp. 1–4.
4. Szultka, A.; Szultka, S.; Czapp, S.; Zajczyk, R. Voltage Variations and Their Reduction in a Rural Low-Voltage Network with PV Sources of Energy. *Electronics* **2021**, *10*, 1620. [[CrossRef](#)]
5. Tonkoski, R.; Lopes, L.A.; El-Fouly, T.H. Coordinated Active Power Curtailment of Grid Connected PV Inverters for Overvoltage Prevention. *IEEE Trans. Sustain. Energy* **2010**, *2*, 139–147. [[CrossRef](#)]
6. Elrayyah, A.; Singh, N.K. Autonomous Control Strategy for Reliable OLTC Operation under PV Power Fluctuation with Effective Voltage Regulation. In Proceedings of the 2020 IEEE Energy Conversion Congress and Exposition (ECCE), Detroit, Michigan, USA, 11–15 October 2020; pp. 2766–2772.
7. Hashemi, S.; Østergaard, J.; Degner, T.; Brandl, R.; Heckmann, W. Efficient Control of Active Transformers for Increasing the PV Hosting Capacity of LV Grids. *IEEE Trans. Ind. Inform.* **2016**, *13*, 270–277. [[CrossRef](#)]
8. Gao, J.; Ge, J.; Zhang, J.; Hu, X.; Li, T.; Wu, J.; Su, Y. Hardware Circuit Design of On-Load Voltage Regulation Switch Based on High Power IGBT. In Proceedings of the 2017 IEEE 2nd Advanced Information Technology, Electronic and Automation Control Conference (IAEAC), Chongqing, China, 25–26 March 2017; pp. 22–25.

9. Zhu, Q.; Chang, F.; Zang, Z.; Li, Z.; Xu, W.; Lv, B. Research on Effective Location of Energy Storage in High-Permeability Photovoltaic Distribution Network. In Proceedings of the 2019 IEEE 3rd International Electrical and Energy Conference (CIEEC2019), Beijing, China, 7–9 September 2019; pp. 1048–1053.
10. Szultka, A.; Szultka, S.; Czapp, S.; Lubosny, Z.; Malkowski, R. Integrated Algorithm for Selecting the Location and Control of Energy Storage Units to Improve the Voltage Level in Distribution Grids. *Energies* **2020**, *13*, 6720. [[CrossRef](#)]
11. Bereczki, B.; Hartmann, B. LV Grid Voltage Control with Battery Energy Storage Systems. In Proceedings of the IEEEIC/I&CPS Europe 2020 IEEE International Conference on Environment and Electrical Engineering and 2020 IEEE Industrial and Commercial Power Systems Europe (IEEEIC/I&CPS Europe), Madrid, Spain, 9–12 June 2020; pp. 1–5.
12. Latorre, H.F.; Ghandhari, M.; Söder, L. Active and Reactive Power Control of a VSC-HVdc. *Electr. Power Syst. Res.* **2008**, *78*, 1756–1763. [[CrossRef](#)]
13. Szultka, A.; Malkowski, R.; Czapp, S.; Szultka, S. Impact of R/X Ratio of Distribution Network on Selection and Control of Energy Storage Units. In Proceedings of the Information and Digital Technologies (IDT), Zilina, Slovakia, 5–7 July 2017; pp. 359–364.
14. Hock, R.T.; de Novaes, Y.R.; Batschauer, A.L. A Voltage Regulator for Power Quality Improvement in Low-Voltage Distribution Grids. *IEEE Trans. Power Electron.* **2017**, *33*, 2050–2060. [[CrossRef](#)]
15. Fawzy, T.; Premm, D.; Bletterie, B.; Goršek, A. Active Contribution of PV Inverters to Voltage Control—from a Smart Grid Vision to Full-Scale Implementation. *Elektrotechnik Inf.* **2011**, *128*, 110–115. [[CrossRef](#)]
16. Shoubaki, E.; Essakiappan, S.; Bhowmik, P.; Manjrekar, M.; Enslin, J.; Laval, S.; Vukojevic, A.; Handley, J. Distributed μ -STATCOM for Voltage Support and Harmonic Mitigation on Low Voltage Networks. In Proceedings of the 2017 IEEE Applied Power Electronics Conference and Exposition (APEC), Tampa, FL, USA, 26–30 March 2017; pp. 925–930.
17. Sagha, H.; Mokhtari, G.; Arefi, A.; Nourbakhsh, G.; Ledwich, G.; Ghosh, A. A New Approach to Improve PV Power Injection in LV Electrical Systems Using DVR. *IEEE Syst. J.* **2017**, *12*, 3324–3333. [[CrossRef](#)]
18. Casolino, G.M.; Di Nitto, B.; Russo, M. Modeling, Testing and Configuring a Transformer for LV Active User Voltage Regulation. In Proceedings of the 2018 International Symposium on Power Electronics, Electrical Drives, Automation and Motion (SPEEDAM), Amalfi, Italy, 20–22 June 2018; pp. 1196–1202.
19. Nakadomari, A.; Shigenobu, R.; Senjyu, T. Optimal Control and Placement of Step Voltage Regulator for Voltage Unbalance Improvement and Loss Minimization in Distribution System. In Proceedings of the 2020 IEEE Region 10 Conference (TENCON), Osaka, Japan, 16–19 November 2020; pp. 1013–1018.
20. Bai, F.; Yan, R.; Saha, T.K.; Eghbal, D. A New Remote Tap Position Estimation Approach for Open-Delta Step-Voltage Regulator in a Photovoltaic Integrated Distribution Network. *IEEE Trans. Power Syst.* **2017**, *33*, 4433–4443. [[CrossRef](#)]
21. Pimenta, A.; Costa, P.B.; Paraíso, G.M.; Pinto, S.F.; Silva, J.F. Active Voltage Regulation Transformer for AC Microgrids. In Proceedings of the 2020 IEEE 9th International Power Electronics and Motion Control Conference (IPEMC2020-ECCE Asia), Nanjing, China, 30 May–3 June 2020; pp. 2012–2017.
22. Ciocia, A.; Boicea, V.A.; Chicco, G.; Di Leo, P.; Mazza, A.; Pons, E.; Spertino, F.; Hadj-Said, N. Voltage Control in Low-Voltage Grids Using Distributed Photovoltaic Converters and Centralized Devices. *IEEE Trans. Ind. Appl.* **2018**, *55*, 225–237. [[CrossRef](#)]
23. Kojovic, L.A. Coordination of Distributed Generation and Step Voltage Regulator Operations for Improved Distribution System Voltage Regulation. In Proceedings of the 2006 IEEE Power Engineering Society General Meeting, Montreal, QC, Canada, 18–22 June 2006; p. 6.
24. Yoshizawa, S.; Yamamoto, Y.; Yoshinaga, J.; Hayashi, Y.; Sasaki, S.; Shigetou, T.; Nomura, H. Novel Voltage Control of Multiple Step Voltage Regulators in a Distribution System. In Proceedings of the ISGT 2014, Istanbul, Turkey, 12–15 October 2014; pp. 1–5.
25. ASTAT. Available online: <https://astat.pl/Produkty/System-Regulacji-Napiecia-Sieci-Nn-Lvr-Sys-a-Eberle-Lvr-Sys/> (accessed on 7 September 2021).
26. System Regulacji Niskiego Napięcia LVRsystTM. Available online: https://astat.pl/pliki/JEE/System_regulacji_napiecia_sieci_nn/LVR_Sys.pdf (accessed on 7 September 2021).