

The Impact of Sloshing Liquids on Ship Stability for Various Dimensions of Partly Filled Tanks

P. Krata

Gdynia Maritime University, Gdynia, Poland

ABSTRACT: Liquid sloshing phenomenon taking place in partly filled ships' tanks directly affects the stability of a vessel. However, only static calculations are carried out onboard ships nowadays and static transfer of liquid weight is taken into account in the course of routine stability calculation. The paper is focused on a dynamic heeling moment due to liquid sloshing in tanks onboard ships. A number of numerical simulations of liquid sloshing taking place in a moving tank is carried out. The wide range of ship's tanks is taken into account. The conducted CFD simulations are experimentally verified. Finally, the method of an assessment of the liquid sloshing impact on ship transverse stability is worked out. The key point of the method is a dynamic coefficient describing relation of the researched dynamic heeling moment and the quasi-static one in terms of dynamic stability of a vessel which is related to the weather criterion of ship stability assessment.

1 INTRODUCTION

The main commonly discussed features of maritime transport are usually its safety and effectiveness. Among them the ship safety issues are crucial from the operational point of view and they can be considered as one of the most prospective technical affairs. One of the most critical features of seagoing ship related to her safety is the transverse stability.

Ship stability is a term used to describe the tendency of a ship to return back to her equilibrium when she is inclined from an upright position (Kobyliński & Kastner 2003). Since the initial position of a ship is not always upright one, the more practical definition states that the stability is a feature enabling to perform, when remaining in determined position, the task she is constructed for. The complementary definitions lead to point out that the stability of a ship is an element of her operational safety qualifying factors.

Ship stability performance depends on two main factors – a shape of her hull and a weights distribution. The first one is a constant value in short and moderate term and can be changed very rarely during rebuilding of a vessel. However, the weights distribution changes in every port due to cargo operations, bunkering and related to both of them ballast operations.

The particular sort of changes in weight distribution onboard is liquid sloshing taking place in partly filled tanks. Moving masses need to be avoided onboard, though it is impossible to evade them at all. The cargo securing procedures ensure a lack of loose cargo onboard but some free surfaces of liquids in ships' tanks are inevitable. The crucial group of tanks onboard ships which may be partly filled are ballast tanks. The problem of an assessment of liquid sloshing effect is nowadays more important than ever because of the obligatory ballast water management requirement. The most common way of maintaining

ballast water clean and safe for the overseas environment is exchanging it during a voyage of a vessel. This operation can be dangerous to the vessel and the fair example of such a danger may be the capsizing of *M/V Cougar Ace*. She lost the stability during ballast water exchanging operation tilting her significantly on heavy swell which resulted the cargo shift and finally laying on her port side (Davis 2008).

The seagoing vessel's stability calculation and evaluation made onboard nowadays is based on the prescriptive stability criteria published by the ship's classification societies (Kobyliński & Kastner 2003). These criteria are mainly based on the A749(18) Resolution of International Maritime Organization. The resolution and their later amendments are known as the Intact Stability Code (ISC 2009).

The ship stability criteria qualify the shape of the righting arm curve. In addition, the weather criterion is to ensure the sufficient stability of a ship to withstand the severe wind gusts during rolling (ISC 2009). Although the weather criterion reflects a very simple model of dynamic ship's behavior, just the static stability curve is used. Anyway, the weather criterion is the only, which is partly based on the model of heeling phenomenon not only on the statistic data, while the remaining criteria are based on the statistics of historical disasters only (Francescutto 2002). The modern and still developing approach towards ship stability qualification is an implementation of performance-based stability criteria in the future. They are based mainly on the risk assessment (Kobyliński & Kastner 2003) however, it is still far from common use onboard ships.

Regardless the approach towards ship stability evaluation, the physical background of phenomena taking place onboard ought to be taken into account. In case of contemporary prescriptive stability standards, the righting and heeling arms need to be obtained and compared. Then the work of the righting arm enabling accumulation and then dissipation of the energy could be compared to the energy provided to the ship by external forces which is called the energy balance method for dynamic stability calculation (Kobyliński & Kastner 2003). The balance of righting arm (righting moment) and heeling arm (heeling moment) shall comprise all significant components of each moment and among others the heeling moment due to liquid sloshing in a partly filled moving tank too.

In the light of ship stability related concepts, the accuracy of ship's transverse stability assessment is an important problem in vessels operation process. Both approaches towards ship stability assessment known nowadays call for characteristics of heeling moment due to liquid sloshing in tanks. This need justifies the research program focused on the liquid sloshing phenomenon.

2 FREE SURFACE EFFECT AND LIQUID SLOSHING PHENOMENON

The intact ship stability assessment is generally carried out onboard on the basis of the IMO IS-Code. Thus, the standard stability measures like a

metacentric height, righting arm curve etc. are in common use. According to the IMO recommendations the righting arm curve shall be corrected for the effect of free surfaces of liquids in tanks. The correction may be done by one of two accepted methods (ISC 2009):

- correction based on the actual moment of fluid transfer calculated for each angle of heel;
- correction based on the moment of inertia of tank's horizontal projection (simple pendulum model).

Both mentioned methods of free surface correction calculation consider the quasi-static attitude towards the sloshing phenomenon only. Consequently they do not consider the location of tanks within the hull of a ship and the location of the rolling axis. However, the main advantage of currently applied compulsory corrections is the simplicity of their calculation.

Regardless the explicit computational IMO-recommended formula for free surface correction, the liquid surface is always assumed flat and depends only on an angle of ship's heel not time. The idea is presented in the sketch (Fig. 1).

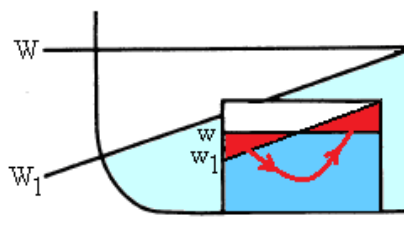

Figure 1. Quasi-static transfer of fluid mass due to ship heeling

The liquid sloshing phenomenon takes place in partly filled ships tanks. As a tank moves, it supplies energy to induce and sustain a fluid motion. Under external large amplitude excitations or an excitation near the natural frequency of sloshing, the liquid inside tank is in violent oscillations which is of great practical importance to the safety of the liquid transport (Zeineb, Chokri, Zouhaier, Khelifa 2010). Both the liquid motion and its effects are called sloshing. The interaction between ship's tank structure and water sloshing inside the tank consists in the constant transmission of energy (Akyildiz & Unal 2005). The exemplary general view on the liquid sloshing phenomenon taking place inside a model tank swinging during an experimental research is shown in Fig. 2.



Figure 2. Exemplary shape of a free surface of liquid inside a partly filled model tank (own research) – it may be clearly

seen that the free surface is far different than assumed within the quasi-static approach (ref. to Fig. 1)

The characteristics of heeling moment due to liquid sloshing depend on a variety of parameters, for instance tank's geometry, its filling level, location of a tank within a hull of a ship, rolling period and others.

The pre-study carried out in the course of the research enabled the classification of typical shapes and dimensions ship tanks (Krata, Wawrzyński, Więckiewicz, Jachowski 2012). The most often designed shapes are shown in figures 3, 4 and 5. The double bottom tanks belongs to standard arrangement of all seagoing ships, while the side tanks and wing tanks are typical for same types only.

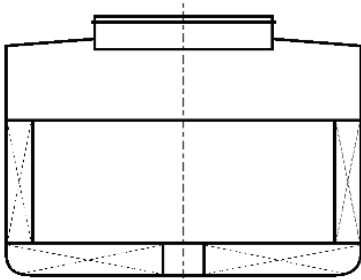

Figure 3. Typical side tanks and wide double bottom tanks

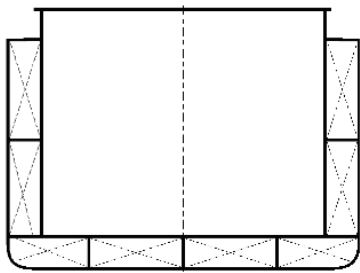

Figure 4. Division of side tanks and double bottom tanks typical for large ships

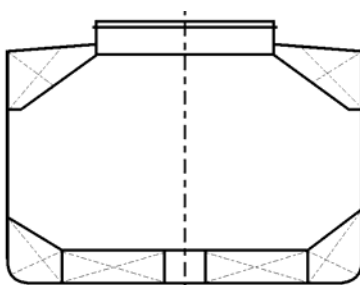

Figure 5. Wing tanks, bilge tanks and double bottom tanks of bulk carriers

The earlier author's researches reveals that liquid sloshing dynamics in ships narrow side tanks can be neglected actually. The natural period of liquid sloshing is short enough to justify the quasi static calculation of the free surface effect. This approach is well known and routinely applied in the course of the stability assessment (ISC 2009). A liquid contained in partly filled side tanks remains in fact horizontal and flat within the ship rolling cycle, which is shown in figure 6. The remaining tanks, e.g. double bottom tanks and wing tanks need to be the subject to examine in terms of possible sloshing characteristics.

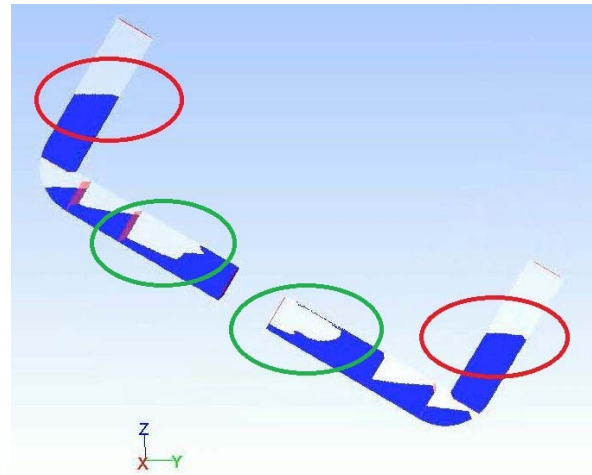

Figure 6. The surface of liquid sloshing in partly filled high side tanks (Krata, Wawrzyński, Więckiewicz, Jachowski 2012)

3 SHIP AND TANK GEOMETRY APPLIED IN THE COURSE OF THE RESEARCH

The tanks onboard seagoing ships can be classified according to their purpose as follows (Krata, Wawrzyński, Więckiewicz, Jachowski 2012):

- trimming tanks (fore and after peaks) which are utilized very often as partly filled due to the need for precise trimming of a ship, so the ballast water level is adjusted according to the variable requirements, thus providing free surface of liquid;
- stability tanks improving ship's stability performance due to a decrease in the vertical center of gravity (usually double bottom tanks located between an engine room and a fore peak creates this group); quite often the breadth of these tanks equals half breadth of a ship or even sometimes it equals full ship's breadth (in ship's fore region) therefore the free surface of liquid can be massive in these tanks so generally they should be full or empty during voyage;
- list control tanks (side tanks) which are usually located amidships and due to their function quite often partly filled with free surface;
- strength control tanks utilized to adjust longitudinal weight distribution (fore and after peaks, double bottom tanks, side tanks and sometimes even cargo holds prepared for ballasting) which are very often partly filled to reduce excessive sheering force and bending moment and routinely they provide free surface of liquid;
- special purpose tanks like for instance anti-rolling tanks (flume) or anti-heeling tanks, which are usually filled up to the 50% level, providing free surface.

Although most of the mentioned tanks are usually filled up to their top or alternatively, they are empty during ship voyage, there are some relatively long periods when they are only partly filled. The most obvious is ballast water exchange applied to meet the requirements of ballast water management instructions providing protection of natural

environment. During the time of such operation the sufficient stability of a ship ought to be maintained.

Regardless the exact purpose of ballast tanks onboard, their total volume and resulting from it total weight of ballast water is significant which is shown in figure 7. This justifies focusing on this group of tanks in the course of the conducted research.

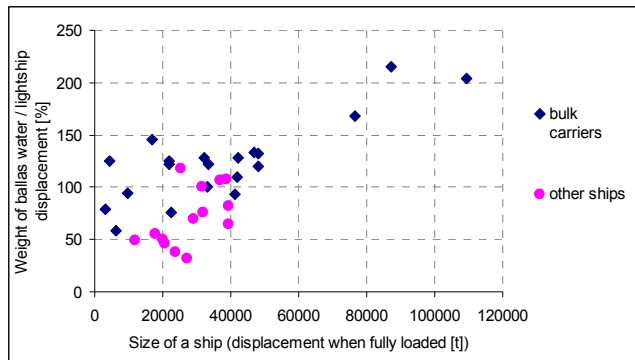

Figure 7. Relation of ballast water weight to the lightship disp. (Krata, Wawrzyński, Więckiewicz, Jachowski 2012)

The graph (Fig. 7) reveals that the total weight of ballast water carried onboard may reach and even exceed the lightship weight among ships other than bulk carriers. Moreover, ballast water weight can be twice a lightship in case of bulk carriers (Krata, Wawrzyński, Więckiewicz, Jachowski 2012). Obviously not all the tanks are partly filled at the same time but some of them can be so which creates the need for stability calculations comprising the phenomenon of moving liquids in tanks.

In the course of the study a typical Panamax ship was taken into consideration. In case of quasi static approach to the free surface effect the location of a partly filled tank does not play any role. Reversely, the dynamic approach is related to ship rolling and the location of considered tank is crucial. Therefore not only the dimensions of a model ship need to be specified but her rolling axis as well. The particulars applied in the research are given in the table 1.

Table 1. Main dimensions of considered ships

| Ship particulars [m] | |
|---------------------------|-------|
| breadth | 32,00 |
| height | 20,00 |
| elevation of rolling axis | 9,00 |

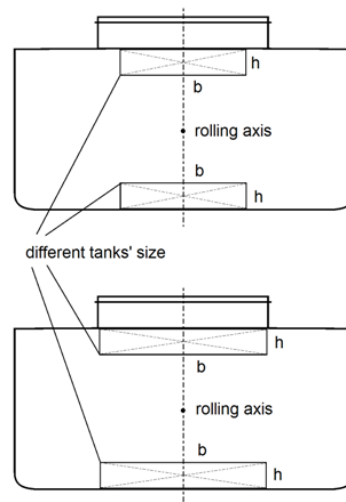

Figure 8. Arrangement of considered tanks in ship's hull

The location of analyzed sample tanks is shown in Fig. 8. The height and breadth of considered tanks are named b and h , respectively.

In order to carry out an analysis the considered model tank has varying size i.e. its breadth b ranges from 5 to 10 meters and its height h ranges from 1,5 up to 4 meters. The filling level of the tank equals 50% in all considered cases.

4 COMPUTATION OF HEELING MOMENT DUE TO LIQUID SLOSHING IN SHIP'S TANK

The heeling moment due to liquid sloshing in a partly filled tank was computed with the use of CFD technique. The software FlowVision was applied. The simulations of liquid sloshing were carried out in 3D mode for the most typical rectangular ship ballast tank. The rolling period was variable according to the research assumptions and the range of angular motion reflects the very heavy sea conditions in extremely stormy weather. The rolling period depends on the stability performance of a considered ship therefore the wide range of such rolling periods is taken into account in the presented study.

The computational mesh applied in the course of the simulations was hexahedral type and related to two coupled reference frames, the stationary and a moving ones which is shown in figure 9. The Sub-Grid Geometry Resolution (SGGR) was applied where the triangulated surfaces naturally cut Cartesian cells and reconstructing the free surface (FlowVision 2010).

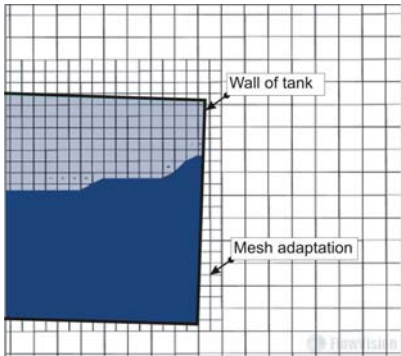
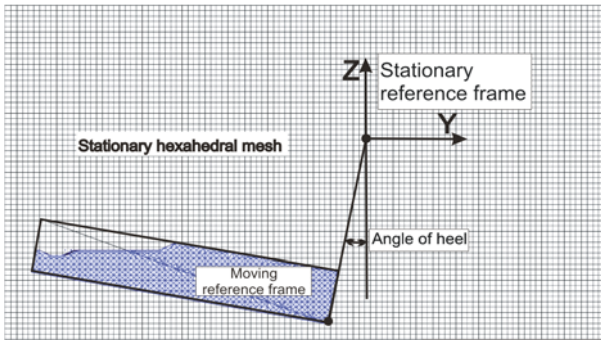

Figure 9. Computational mesh and two coupled reference frames systems

The SGGR method is intended for an approximation of curvilinear boundaries on a hexahedral mesh. The method consists in natural splitting of the boundary cells by the triangulated boundaries which is shown in figure 10.

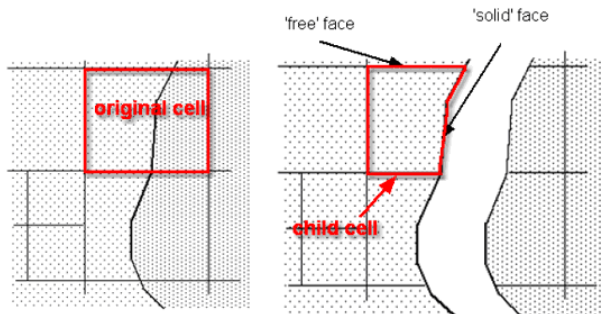

Figure 10. Sub-grid resolution of curvilinear wall (FlowVision 2010)

The number of the obtained child cells depends on the geometry peculiarities. The child cells are arbitrary polyhedrons. The equations of a given mathematical model are approximated on the polyhedrons without simplifications. The approach enables accurate calculations in a complex domain on a reasonably coarse mesh (FlowVision 2010).

The FlowVision code is based on the finite volume method (FVM) and uses the volume of fluid method (VOF) for free surface problems which is presented in figure 11 (FlowVision 2010).

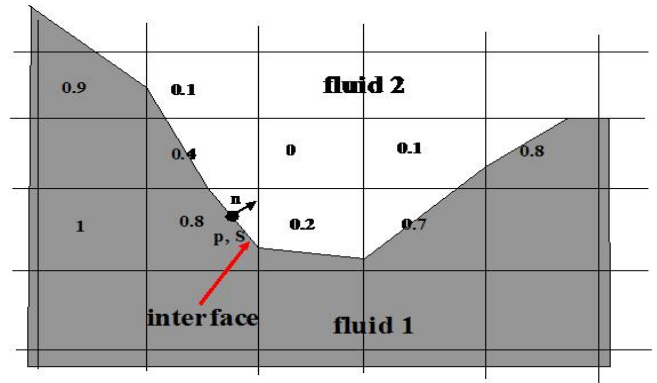

Figure 11. VOF (Volume Of Fluid) variable is the volume fraction of fluid 1 in a cell; VOF=1 - the cell contains only fluid 1; VOF=0 - the cell contains only fluid 2; $0 < \text{VOF} < 1$ the cell contains fluid 1 and fluid 2 (FlowVision 2010)

High accuracy of computation is achieved by solving the governing equations in the 'free surface' cells (the cells partly filled with liquid) (FlowVision 2010). The RANS (Reynolds-averaged Navier–Stokes) equation is implemented and the simulation of turbulent flows is based on the eddy viscosity concept. The semi-empirical $k-\epsilon$ model turbulence model was applied.

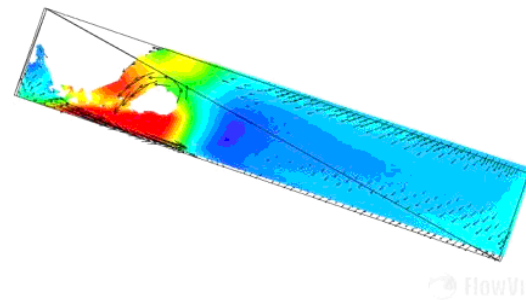

Figure 12. Computed shape of a free surface in a moving tank (example)

The result of the simulation comprises mainly the general flow pattern and the velocity and pressure fields. The exemplary shape of a free surface is shown in Fig. 12.

Moreover, the user defined parameter was also computed, i.e. the heeling moment due to liquid sloshing inside partly filled tank which is essential from the conducted research point of view. The heeling moment \mathbf{M} vector was calculated according to the following formula:

$$\mathbf{M} = \int_s \mathbf{r} \times \mathbf{n} \cdot p \, ds \quad (1)$$

where:

- S – the wetted surface of the tank's shall;
- \mathbf{r} – the position vector of the considered point on the tank's wall;
- \mathbf{n} – the normal vector;
- p – the local pressure on the tank's wall.

Due to the prevailing two-dimensional character of the considered flow in the tank, the heeling moment is a vector of a direction perpendicular to the plane of the tank's movement. As the transverse



stability of a ship is assumed to be considered, the heeling moment may be described by one spatial component only, as follows (Krata 2009):

$$\mathbf{M} = [M_x, M_y, M_z] = [M_x, 0, 0] \quad (2)$$

where:

M_x , M_y , M_z – spatial components of \mathbf{M} vector, determined about the x , y and z axis in the reference system related to the vessel.

For further use the sole non-zero component M_x of the computed heeling moment due to liquid sloshing which is described by the formula (2) was named the total dynamic moment and marked $M_{Total, dyn}$. Such heeling moment was the subject for post processing and reasoning.

5 EXPERIMENTAL VERIFICATION OF NUMERICAL SIMULATIONS

Although the CFD-based numerical simulation of liquid sloshing in a partly filled tank is a powerful technique, it still requires an experimental verification for some cases. Generally, the experiment is commonly found as an unambiguous prove for the correctness of numerical computations. Therefore, the experimental research into the sloshing phenomenon was carried out in Ship Operation Department at the Gdynia Maritime University.

The main part of the apparatus is a tank equipped with pressure transducers. The tank is forced to oscillating motion by the hydraulic drive mechanism, thus exciting the water sloshing inside it. The dimensions of the model tank are: breath – 1,040 m, length – 0,380 m, depth – 0,505 m. The general view of the utilized testing apparatus is shown in figure 13.

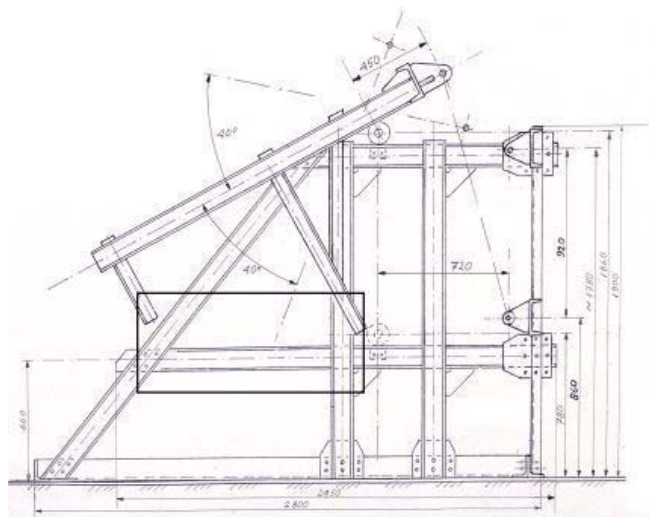

Figure 13. Experimental setup - general arrangement

The experimental setup enabled to measure the dynamic pressure distribution on the side wall of the model tank and in its upper corner. Furthermore, it was feasible to record a shape of free surface for any angle of tank's tilt.

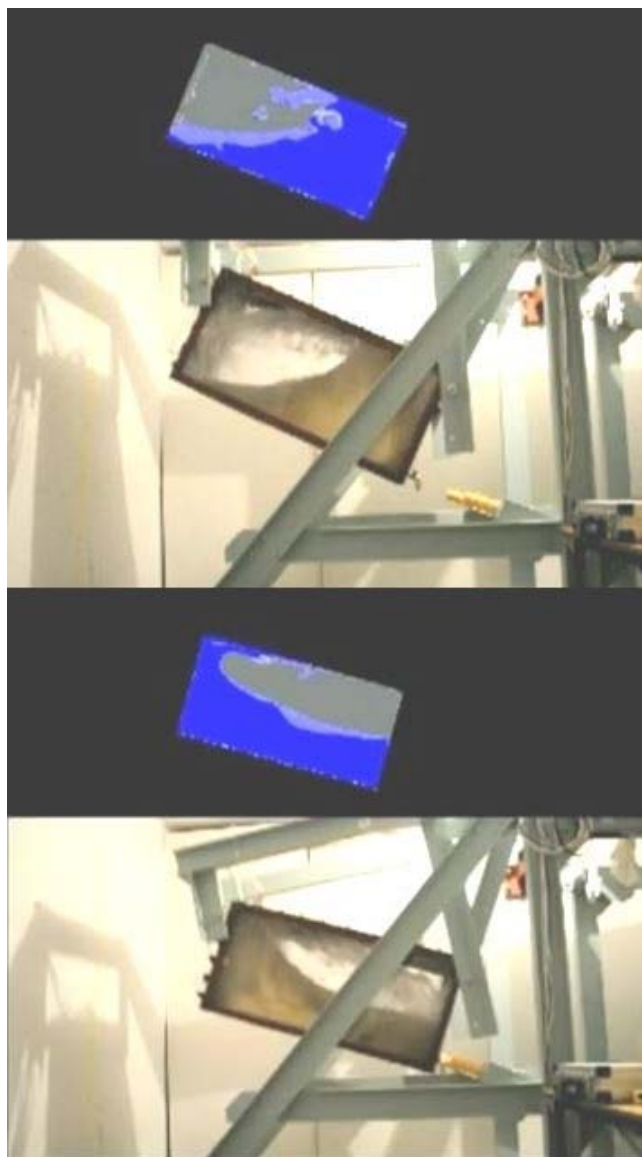

Figure 14. Comparison of a shape of free surface: experiment (lower photos) and numerical simulations (upper graphics)

Despite the dynamic pressure distribution the shape of free surface of liquid sloshing in the tank was recorded for numerous runs of the experiment. The liquid distribution and a velocity field are governed mostly by the inertia of liquid mass and a pressure field. As a consequence, the correct modeling of liquid's free surface emerges as a strong prove for the correctness of the CFD-based numerical simulations of sloshing flows. The exemplary comparison of free surfaces recorded in a model tank during experiment and computed in the course of simulations is shown in figure 14.

The pressure history in the control points of the tank obtained in the course of the experiment were compared to the computed ones. Then the shape of liquid's free surface was confirmed. Both experimental results the pressure and the free surface meet relevant results achieved by the use of CFD simulations. Consequently, the results of simulations were acknowledged as correct and reliable.

6 EVALUATION OF SLOSHING LIQUID IMPACT ON SHIP STABILITY

The obtained history of heeling moment due to liquid sloshing in tanks was decomposed into two components. The first one comprises the moment due to dynamic action of solid-like liquid (i.e. 'frozen') at an angle of heel equal 0 degrees. The second component of the dynamic heeling moment due to liquid sloshing covers only the moment resulting from letting free the liquid to slosh inside the tank (Krata, Jachowski, Wawrzyński, Więckiewicz 2013). All moments (components) are computed about the ship rolling axis which is fixed at the symmetry plane of a vessel at an elevation given in the table 1 for the considered ship.

The component containing the moment resulting from the solid-like liquid is included in the weight distribution calculation. And the remaining dynamic component of the heeling moment due to liquid sloshing which may be called 'the free floating component' is the matter of this paper. The core idea of this approach may be expressed by the formula:

$$M_{Total_stat} = M_{FL_stat} + M_T \quad (3)$$

$$M_{Total_dyn} = M_{FL_dyn} + M_{Ff} \quad (4)$$

where:

M_{Total_stat} – total static moment due to a presence of liquid with free surface in a tank;

M_{FL_stat} – static heeling moment due to the weight of frozen-like liquid in a tank;

M_T – static heeling moment of fluid transfer calculated for each angle of heel;

M_{Total_dyn} – total dynamic moment due to liquid sloshing in a tank;

M_{FL_dyn} – dynamic heeling moment due to the weight of solid-like liquid in a tank;

M_{Ff} – free floating component of the dynamic moment due to liquid sloshing.

The exemplary result of CFD computations is presented in figure 15. The total dynamic moment due to liquid sloshing in a tank M_{Total_dyn} is obtained in time domain.

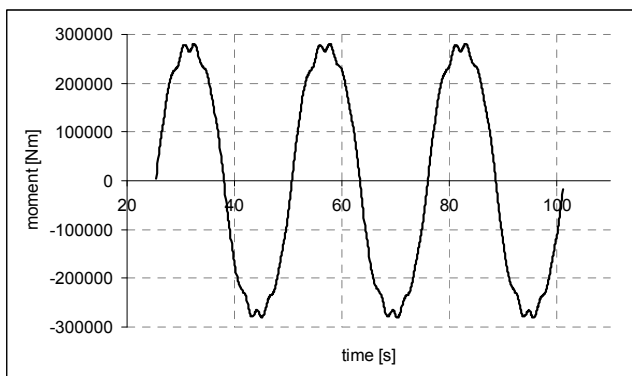

Figure 15. History of heeling moment M_{Total_dyn} due to liquid sloshing in the considered tank –sample case

As the momentary angle of ship's heel is known for every time step of CFD computations, the heeling moment may be plotted versus an angle of heel as well. This is a convenient approach which is shown in figure 16.

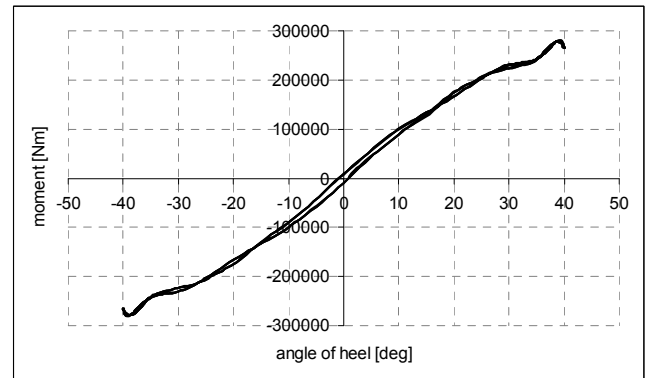

Figure 16. Heeling moment M_{Total_dyn} due to liquid sloshing versus an angle of ship's heel – sample case

The next heeling moment emerging in the formula (4) is the dynamic heeling moment due to the weight of solid-like liquid in a tank. This moment is shown for an exemplary case in figure 17.

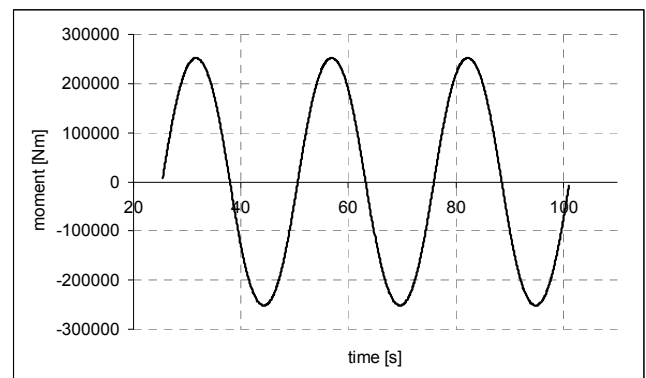

Figure 17. History of the dynamic heeling moment M_{FL_dyn} due to the weight of solid-like liquid in a tank – sample case

Similarly to the total heeling moment, this moment due to the solid-like weight in a tank can be plotted versus an angle of heel – like in figure 18.

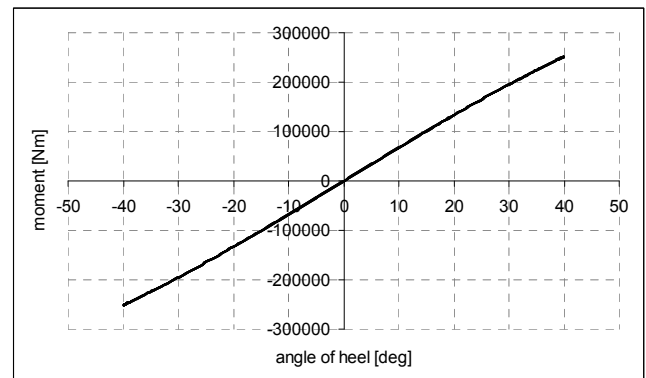

Figure 18. Dynamic heeling moment M_{FL_dyn} due to the weight of solid-like liquid in a tank versus an angle of ship's heel – sample case

According to the formula (4) the core component of the heeling moment due to sloshing is a difference

between the total dynamic moment due to liquid sloshing and the dynamic moment due to solid-like weight in a tanks. The result is shown in figure 19.

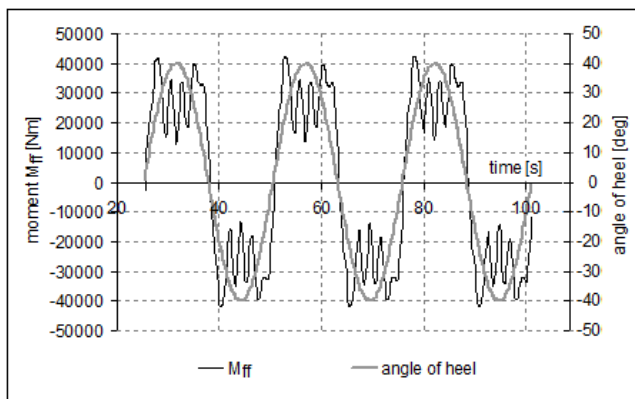

Figure 19. History of the free floating component M_{ff} of the dynamic moment due to liquid sloshing – sample case

However, the most convenient way of presentation of the free floating moment is a graph plotted versus an angle of ship's heel which is presented in figure 20.

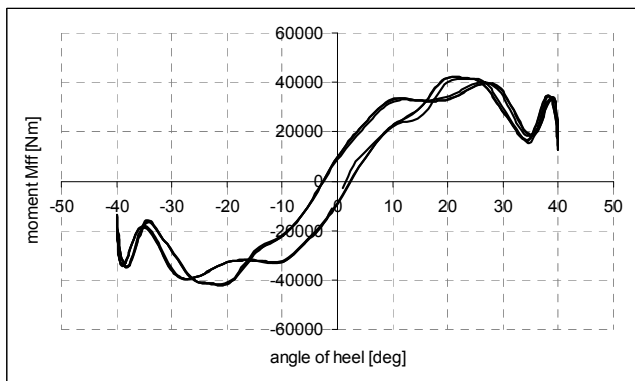

Figure 20. Free floating component M_{ff} of the dynamic moment due to liquid sloshing plotted versus an angle of ship's heel – sample case

The key point of the research is an attempt to evaluate the impact of the heeling moment due to liquid sloshing in tanks. The most convenient approach seems to be a sort of comparison of the free floating component of the dynamic moment due to liquid sloshing M_{ff} and the contemporary utilized quasi-static moment M_T due to fluid transfer in a tank (refer to formulas 3 and 4).

Addressing the problem of comparison of the M_{ff} and M_T components of the heeling moment due to liquid motion, the aggregative variable was worked out and named the "dynamic coefficient". This coefficient refers to the dynamic stability of a vessel or in other words to the weather criterion of the intact ship stability assessment which is based on the energy balance method of stability calculation (Kobyliński & Kastner 2003).

In the case of asymmetric location of ship tanks, the dynamic coefficient needs to be calculated separately for a port side tank (coefficient kd_L) and a starboard one (kd_P respectively). However, usually similar tanks are located symmetrically on both sides of a vessel. Moreover, such couples of tank are usually full, empty or partly filled. Thus, in such cases

the dynamic coefficient may be calculated for both partly filled symmetrical tanks simultaneously (coefficient kd_{sr}). The definitions of applied coefficients are given by following formulas:

$$kd_P = \frac{W_{M_{ff-P}}}{W_{M_T-P}} = \frac{\int_0^{\varphi_A} M_{ff} \cdot d\varphi - \int_0^{\varphi_A} M_{ff} \cdot d\varphi}{\int_0^{\varphi_A} M_T \cdot d\varphi - \int_0^{\varphi_A} M_T \cdot d\varphi} \quad (5)$$

$$kd_L = \frac{W_{M_{ff-L}}}{W_{M_T-L}} = \frac{\int_0^{-\varphi_A} M_{ff} \cdot d\varphi - \int_0^{-\varphi_A} M_{ff} \cdot d\varphi}{\int_0^{-\varphi_A} M_T \cdot d\varphi - \int_0^{-\varphi_A} M_T \cdot d\varphi} \quad (6)$$

$$kd_{sr} = \frac{kd_P + kd_L}{2} \quad (7)$$

where:

- $W_{M_{ff-P}}$ - work of moment M_{ff} during ship's heeling to starboard side;
 - W_{M_T-P} - work of moment M_T during ship's heeling to starboard side;
 - $W_{M_{ff-L}}$ - work of moment M_{ff} during ship's heeling to port side;
 - W_{M_T-L} - work of moment M_T during ship's heeling to port side;
 - φ - angle of ship's heel
 - φ_A - amplitude of rolling;
- remaining symbols like in formulas (3) and (4).

On the basis of introduced dynamic coefficients (formulas 5, 6 and 7) a set of sample calculations was carried out. The ship particulars taken into account reflect round Panamax size which particulars are given in the table 1. The size and location of considered tank are shown in figure 8. The results e.g. the values of a dynamic coefficient kd_{sr} versus size of a tank are presented in figure 21.

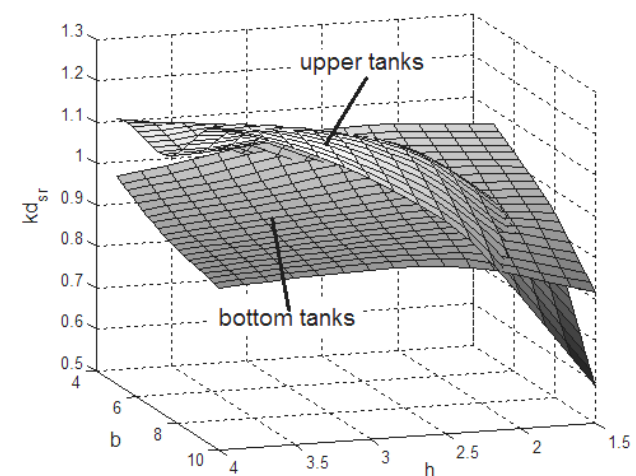

Figure 21. Correction factor kd_{sr} for different location and dimensions of considered tanks

It ought to be emphasized that the considered dynamic coefficient comprises only the effects of the M_{ff} and M_T components of the heeling moment due to liquid motion. The value $kd_{sr}=1$ indicates the dynamic effect of liquid sloshing equal to the static one in terms of ship transverse stability when heavy rolling on sea waves. The value $kd_{sr}=0$ denotes a lack of the dynamic effect of liquid sloshing in a partly filled tank which could be possible due to the wave character of sloshing flow and a noticed phase shift. Such a phenomenon is utilized in anti rolling devices (flume tanks) and it is also encountered during liquefied cargo carriage (Warmowska, Jankowski 2006).

The characteristics presented in the figure 21 reveals that the value of the considered dynamic coefficient neither exceeds significantly $kd_{sr}=1$ for double bottom ship tanks nor drops often below $kd_{sr}=0,9$. Contrary to the double bottom tank location the upper tanks are more sensitive in the context of dynamic coefficient variation. The coefficient kd_{sr} ranges from 0,6 for the widest and lowest analyzed tank ($b=10$ m and $h=1,5$ m) up to almost 1,3 for the highest tank. Thus, the actual impact of liquid sloshing phenomenon on ship transverse stability can be notably lower than expected on the basis of IMO IS-Code or remarkably greater for some cases as well.

7 CONCLUSION

The study presented in the paper is focused on the dynamic effects of liquid sloshing taking place in partly filled ship tanks. The decomposition of the dynamic heeling moment due to liquid sloshing was applied. Then the further processing of a free floating component enabled implementation of a novel variable named a dynamic coefficient. The coefficient corresponds with the energy balance method of ship dynamic stability calculations and thanks to this it is compatible with the weather criterion recommended by the IMO Intact Stability Code.

A set of sample calculation of the dynamic coefficient was carried out for double bottom tanks and upper ones. The wide range of tank's dimensions was taken into account.

According to the obtained results of the conducted research, a significant number of ship tanks arrangement arouses the liquid sloshing phenomenon generating less severe impact than assumed in the course of contemporary quasi-static approach. However, the results reveal also the possibility of greater impact of sloshing liquid in a tank than it is expected on the basis of contemporary quasi-static calculations.

Such a conclusion may be important from the economical point of view. Ship stability standards quite often restrict the capability of a vessel to carry as much cargo as could be physically loaded. The so

called safety margin is maintained. The common application of the proposed dynamic coefficient could result in less demanding stability standards still providing the assumed level of ship safety in terms of her transverse stability. It may be especially important in the age of economical crisis and a worldwide tendency to cost optimization. Any extra cargo carried over the current restrictions contributes to the ship operator's revenue. It could be accepted when without any significant decay of safety standard onboard. Thus, arousing a discussion on IMO forum seems to be justified.

ACKNOWLEDGMENT

The research project was funded by the Polish National Science Centre.

REFERENCES

- Akyildiz H., Unal E., „Experimental investigation of pressure distribution on a rectangular tank due to the liquid sloshing”, *Ocean Engineering* 32 (2005), www.sciencedirect.com
- Davis J. High Tech Cowboys of the Deep Seas: The Race to Save the Cougar Ace, http://www.wired.com/science/discoveries/magazine/16-03/ff_seacowboys
- FlowVision HPC Manual, Capvidia, Belgium 2010.
- Francescutto A., Intact Ship Stability - the Way Ahead, Proceedings of the 6th International Ship Stability Workshop, Washington, 2002.
- International Code on Intact Stability 2008, edition 2009, IMO, London 2009.
- Kobyliński L.K., Kastner S., *Stability and Safety of Ships*, Vol. I. Elsevier 2003.
- Krata P., Linear characteristics of sloshing phenomenon for the purpose of on-board ship's stability assessment, *Journal of Theoretical and Applied Mechanics (JTAM)*, Vol. 47, No 2, pp. 307-320, Warsaw 2009.
- Krata P., Jachowski J., Wawrzyński W., Więckiewicz W., The dynamic heeling moment due to liquid sloshing in partly filled wing tanks for varying rolling period of seagoing vessels, *Marine Navigation and Safety of Sea Transportation – Weintrit & Neumann (ed.)*, Vol. Maritime Transport & Shipping, Chap. Hydrodynamics and Ship Stability, CRC Press Taylor & Francis Group – Balkema Book, pp. 303-310, Boca-Raton-London-New York-Leiden 2013.
- Krata P., Wawrzyński W., Więckiewicz W., Jachowski J., Ship's ballast tanks size and dimensions review for the purpose of model research into the liquid sloshing phenomenon, *Scientific Journals of Maritime University of Szczecin*, 29(101) pp. 88–94, Szczecin 2012.
- Warmowska M., Jankowski J.: Ship motion affected by moving liquid cargo in holds, *Proceedings of the Krajowa Konferencja Mechaniki Płynów, Bełchatów 2006*.
- Zeineb S., Chokri M., Zouhaier H., Khelifa M., Standing wave induced by free liquid sloshing in rectangular tank, *Proceedings of the International Renewable Energy Congress, Sousse, Tunisia, November 5-7, 2010*.

