

# HEALTH MONITORING OF A COMPRESSION IGNITION ENGINE FED WITH DIFFERENT LOW-SULPHUR MARINE FUELS BY ENDOSCOPIC IMAGE PROCESSING AND ANALYSIS

Zbigniew Korczewski\* 

Gdansk University of Technology, Poland

\* Corresponding author: [zbikorc@pg.edu.pl](mailto:zbikorc@pg.edu.pl) (Zbigniew Korczewski)

## ABSTRACT

*This article characterises the methodology for the endoscopic testing of a laboratory diesel engine used for testing marine fuels. The 'Shadow' measurement method used in the XLG3 type EVEREST digital endoscope, for quantitative and qualitative identification of detected surface defects, was approximated. Representative endoscopic images of the elements limiting the working space of the research engine are demonstrated, having been recorded during the usable quality testing of newly produced, low-sulphur marine fuels, so-called 'modified fuels'. The main purpose of the endoscopic examinations was the final verification of the tested fuel's suitability for feeding full-size marine engines.*

**Keywords:** low-sulphur marine fuels, usable quality, engine tests, health monitoring, endoscopic examinations

## INTRODUCTION

Permanently inflated emission standards, with respect to the release of harmful toxic components in the exhaust gases of marine engines, enforce the application of various types of exhaust purifying (neutralising) devices, e.g. wet 'scrubbers' or dry 'sorbers', as well as non-standard marine fuels [1]. These are usually low-sulphur fuels, the so-called 'modified (blended) fuels', produced by the mechanical mixing of Marine Gasoil (MGO) type distillate based fuel with RMG380 type residual marine fuel oil in an appropriate mass ratio [6]. The propellant oils obtained in this way should be subjected to comprehensive numerical tests, by means of accessible utility computer programs that enable simulating engine working processes, within:

- energy performance [14],
- fuel combustion [10],
- exhaust chemical emissions [7] [11],
- fuel injection [13], and
- working medium exchange [9].

Experimental engine tests should then be carried out in laboratory conditions. Their main purpose should be to determine the usable quality of the non-standard fuel before it enters use in ship operations. Experimental testing of the fuel is most often carried out on specially designed small-scale engine stands, which imitate the essential design and parametric features of a real object [5] [15] and, very rarely, on full-size marine engines [4] [16].

In order to carry out a comparative analysis of the impact of various types of modified marine fuels on the energy state of a diesel research engine (in terms of its performance, efficiency and chemical emissivity of exhaust gases), parametric tests should be conducted according to the established program. The methodology for carrying out this type of research was developed at the Department of Ship Power Plant in the Gdańsk University of Technology [6]. This research makes it possible to determine the nature of the impact of the elemental composition and the calorific and ignition properties of the applied fuel on the selected performance and emission parameters of the research engine. It also enables

determination of the position of the fuel when ranking the usable quality of the previously tested marine fuels [5]. Engine tests are preceded by the proper preparation of a fuel sample, delivered by the manufacturer (or shipowner) in an appropriate amount; this includes its purification and initial assessment of the combustion process quality in the bomb calorimeter [20].

After completing the program of parametric tests on the laboratory engine powered by the tested marine fuel, direct, optical assessment (verification) of its technical condition should be started, in terms of the injection apparatus, as well as working space. Until then, the engine should be started several times from a cold state, with manual switching of the fuel fed system from distillate fuel to the modified marine fuel under test (and vice versa). The engine should be also loaded according to the propeller or regulator characteristics in the adjusted range of torque and crankshaft rotational speed variations. The structural verification of the engine should be carried out after at least 20 hours running time.

First, the injector and the injection pump should be removed from the engine, which are subjected to further diagnostic examinations on specialised test beds, and then disassembled and optically verified, particularly their precise couples (friction nodes) [6].

In the last stage of the research, an endoscopic assessment of the working space and technical state of the engine is carried out, in accordance with the previously developed methodology for conducting this type of diagnostic test [5].

## RESEARCH METHODOLOGY AND APPLIED MEASURING APPARATUS

Detection of the material surface defects of elements limiting the working spaces of a piston internal combustion engine, by means of optical and digital endoscopes, is one of the youngest methods of technical diagnostics [2] [12]. Today this kind of measuring apparatus is widely applied to the operation of automotive engines [8]. Its high diagnostic efficiency is also known, in terms of industry and marine engine operation [3] [18]. This is particularly important in the early stages of their development, when the observed parameters of the diagnostic systems are not sufficiently sensitive to changes in the state of the surface layers. On the

basis of the nature and size of the identified surface defects and damage, it is not only possible to assess the technical condition of directly accessible structural elements of the engine's working space, but also (indirectly) to assess the technical condition of those structural elements of the engine that are not directly accessible and which cooperate with workspaces. Thus, on the basis of the endoscopic examination of the cylinder surface and the nature of the surface defects detected on it, an indirect diagnosis can be made regarding the technical condition of the ring or guiding part of the piston, although it is not possible to make a direct endoscopic assessment of the technical condition of these areas of the piston. The basic condition for reliable endoscopic diagnoses of the technical condition of engine working spaces is the ability to make, not only a qualitative, but also a quantitative, assessment of the detected surface defects. Digital endoscopy brings completely new possibilities in this regard. Digital image analysers, cooperating with the 'StereoProbe', 'ShadowProbe', 'Laser-Dots' and 'PhaseProbe' measuring heads, allow for digital processing of stereoscopic effects, which enables dimensioning of the seen images of surface defects in such a way that they give the impression of quasi-three-dimensionality, with their depth, solidity and mutual arrangement (Fig. 1). Analysis of the literature on the subject indicates that there is a great importance for the diagnosis of such a method of identifying damage. On the basis of the available statistical data and the results of the author's own research, it can be concluded that the application of endoscopic methods can now detect most of the operational damage to the working spaces of the engine (also identified by other diagnostic methods).

The qualitative (optical) and quantitative (digital) assessment of the technical condition of the working space of a Farymann Diesel D10 type single-cylinder diesel research engine with a pre-combustion chamber, presented in this article, was carried out using the Everest XLG3 type industrial video endoscope equipped with a 'ShadowProbe' measuring head [17]. Endoscopic diagnostic examinations were aimed at estimating the intensity of the degradation process of an engine's structural elements under feeding conditions with various types of distillation and residual marine fuels, including low-sulphur, modified (blended) ones [6]. So far, six different low-sulphur marine fuels have been tested; the basic physical and chemical properties are summarised in Table 1.

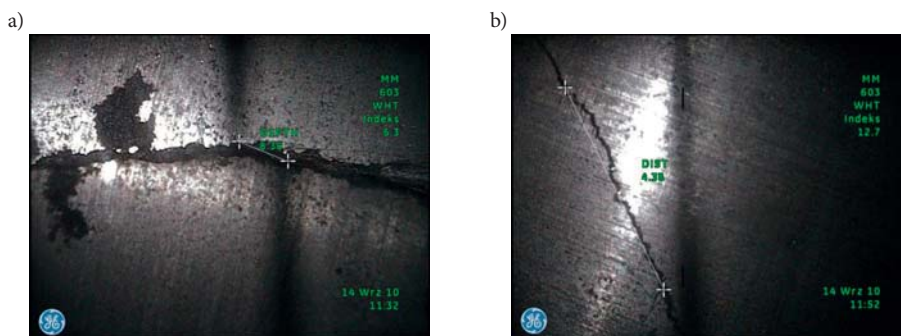

Fig. 1. Endoscopic image of crack in the cylinder liner of the Bukh Diesel E100 engine, dimensioned with the 'Shadow' method: a) step of the cracked cylinder surface layer – 8.30 mm, b) length of the step crack – 4.38 mm

Tab. 1. Measurement results of elemental composition, as well as energy and ignition properties, of the considered low-sulphur marine fuels

PARAMETER	MGO	MDO	RMD 80/L	RMD 80/S	RME 180	RMG 380
The content of carbon C, % m/m	86.26	86.63	86.14	86.54	86.12	86.10
The content of hydrogen H, % m/m	11.10	11.20	11.72	11.75	11.80	11.90
The content of nitrogen N, % m/m	0.05	0.04	0.027	0.02	0.02	0.02
The content of sulphur S, % m/m	0.09	0.008	0.028	0.10	0.01	0.01
Gross calorific value, MJ/kg	46.20	45.68	46.01	45.41	46.19	46.03
Net calorific value, MJ/kg	43.23	42.70	43.04	42.44	43.20	43.08
Cetane Number (CN) / Calculated Carbon Aromaticity Index (CCAI)	57.2	51.0	755.0	791.0	750.0	747.0
Density at 15°C, kg/m <sup>3</sup>	827.1	820.0	872.7	885.0	878.7	884.5
Kinematic viscosity at 40°C (dist.) / 50 C (res.), mm/s	2.99	2.37	77.83	16.48	165.30	308.00

During the endoscopic examination, special attention was paid to the cleanliness of the whole working space. In addition, one should pay attention to the presence of surface corrosion and erosion defects, as well as products of incomplete fuel combustion on the piston crown, bottom plate of the cylinder head, cylinder liner surface and on the valve heads and seats (faces).

Figure 2 shows a general view of the XLG3 video endoscope ready for usage. This device comprises a complex diagnostic system and enables the inspection of the internal spaces of the engine through existing or specially made technological openings, with a diameter of at least 7 mm. The XLG3 was equipped with a replaceable inspection probe with the following parameters: diameter 6.1 mm, length 3.0 m. The probe tip was controlled by a joystick located on the handle (articulation control, with electronic position lock function and automatic return to the straightened position of the probe) and allowed the probe to be bent by 120° in any direction (up-down / left-right).

The optical image was converted into an electronic image by means of a CCD SUPER HEAD TM camera, with a diameter of 4.2 mm and a resolution of 440,000 pixels, placed in the head of the speculum. This provided continuous digital zoom and left-right image reversal. The digital recording of the colour image was sent via the transmission rail (signal wires) of the inspection probe to the central unit of the endoscopic set. Then, the image 'passed' through digital processors and was sent to the LCD monitor mounted in the handle of the video probe, above the manual panel. The inspection probe of the video endoscope has replaceable tips, enabling observation in the frontal and lateral sectors at different angles and, because of this, the possibility of manually inspecting the internal spaces of the engine are significantly increased. It is also possible to replace the lenses of the speculum head from standard to measuring ones in operating conditions, without the need for additional tools and breaks in testing. This way of dimensioning surface defects by means of the 'Shadow' method (or any other) is ensured; the probe is protected against mechanical damage by an external tungsten braid.

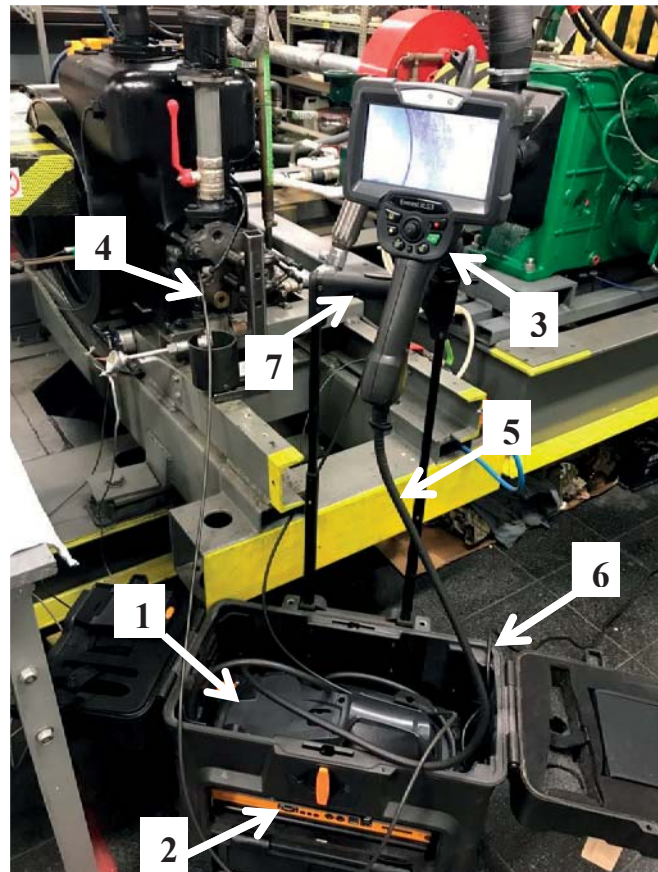

Fig. 2. General view of the Everest XLG3 measuring video endoscope ready for usage (Farymann Diesel D10 type research engine in the background): 1 – central unit, 2 – control panel, 3 – videoprobe handle with a manual panel and monitor, 4 – inspection probe, 5 – optical fibre of the object illumination, 6 – suitcase, 7 – transport (assembly) handle

The XLG3 video endoscope is equipped with a source of cold white light (a 75W HID discharge lamp – the arc tube), with a guaranteed life span of 1000 hours, which is placed in the device's housing. The light is white and the colour temperature of the light source is about 5000 K. The video endoscope application software enables the measurement of detected damage and surface defects using the 'Shadow' method, as well as digitally saving recorded images (photos and videos) in the following formats: BMP, JPG, and MPEG4. These can be saved in the internal memory (50 GB) or on a removable USB drive.

In order to gain access to the working space of the research engine, the injector was removed from the cylinder head and the sight glass probe of the video endoscope was introduced (Fig. 3 and 4). Endoscopic examination should be carried out with special precautions. Failure to comply with the basic procedures of conduct during the endoscopic examinations may result in the destruction of the video probe, damage to the structural elements of the engine, and, even, its complete immobilisation, as a result of accidental entry into the working spaces of the so-called 'foreign objects' (e.g. the cut end of the inspection probe). The most important principles and methodological recommendations, which must be categorically followed in order to ensure rational usage of the endoscopic system for diagnosing internal combustion engines, were described in the publication devoted to the operational diagnostics of marine engines [6].

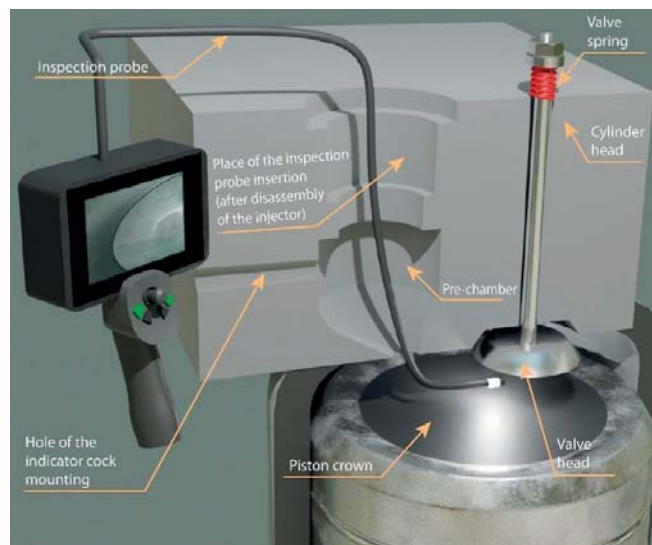

Fig. 4. Longitudinal section of the cylinder head of the Farymann Diesel D10 engine with the marked place of entering the video endoscope inspection probe

## SURFACE DEFECT DIMENSIONING TECHNOLOGY

The tip of the video endoscope's 'Shadow' inspection head is equipped with specialized optics, generating a straight-line shadow in the luminous flux (like a projector) on the surface of the examined element. The projection of the shadow takes place at a known angle of the sighting head in relation to the observed surface and a known angle of the observation sector. The shadow generated near the detected defect is then located and recorded by a CCD camera placed in the assembly head. The closer the inspection head is to the observed surface, the closer the shadow line is to the left hand side of the monitor screen. Since the position of the shadow generating the image on the matrix of the LCD monitor screen is known, it is possible to easily calculate the magnification of this image and determine the linear dimension of the distance between individual pixels, as well as the actual dimensions of the detected surface defects, from dependencies (1) and (2) (Fig. 5).

The diagnostician confirms the position of the shadow line on the monitor matrix by superimposing the cursor line on the shadow (dashed line in Fig. 5). In this way, the digital coordinates of the shadow line are determined. In Fig. 5, the

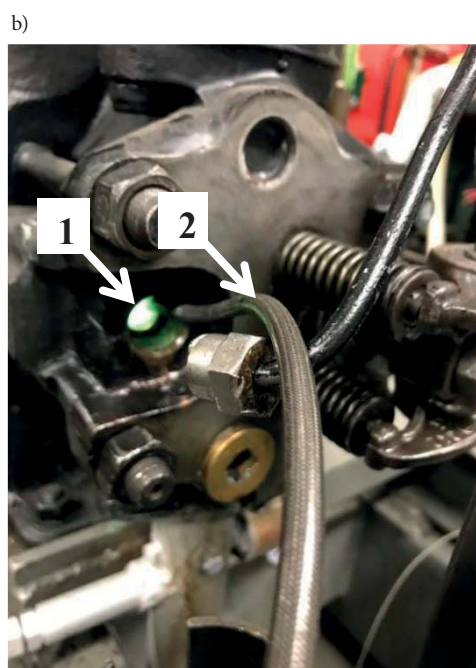
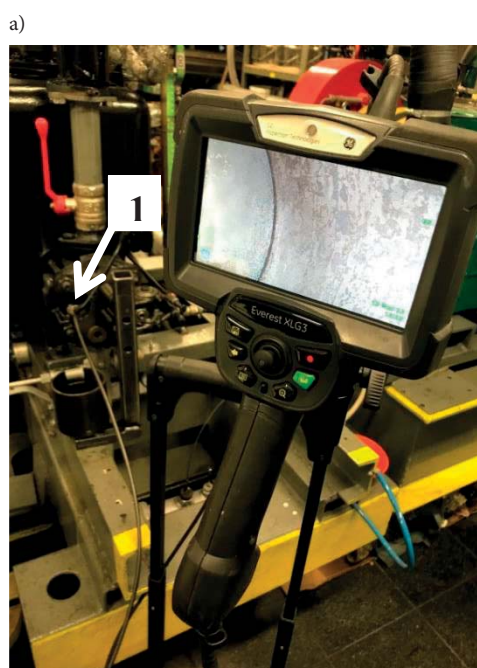

Fig. 3. View of the XLG3 manual endoscope panel with a visible image of the cylinder space of the Farymann Diesel research engine type D10 (a) way of inserting the inspection probe of the video endoscope into the research engine working space (b) 1 – inspection hole after removing the fuel injector, 2 – inspection probe

digital position of the shadow line on the monitor matrix corresponds to  $X=150$  pixels, counted from the left side of the screen. The calibration data of the applied measuring head, stored in the computer database of the video endoscope, show that this corresponds to the distance of the probe lens from the observed surface of (for this example) 20 mm.

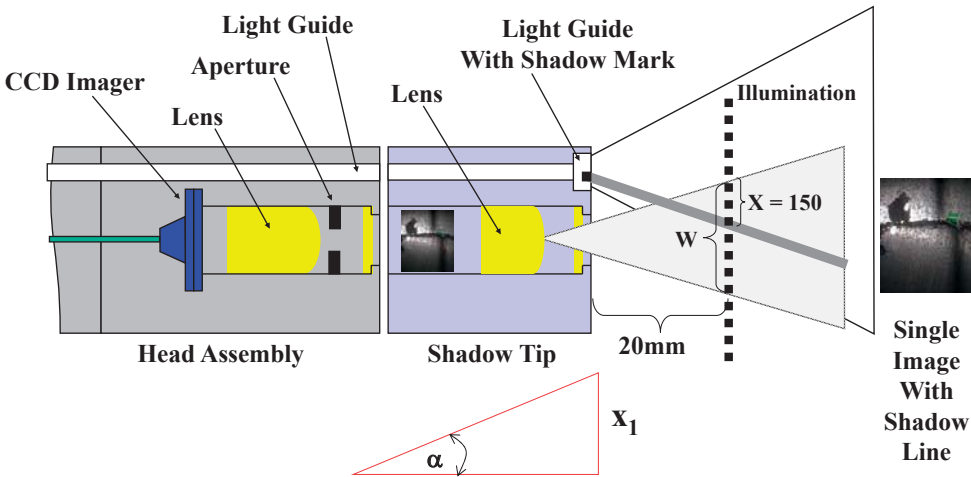

Fig. 5. Schematic diagram of the 'Shadow' measurement method [19]

The calculation algorithm of the video endoscope computer, by using simple trigonometric relationships for the field of view angle of the measuring head  $50^\circ$  ( $\alpha = 50^\circ/2$ ), determines the  $X_1$  coordinate on the monitor matrix from the equation:

$$X_1 = tg\alpha \cdot 20 \text{ mm} = tg25^\circ \cdot 20 \text{ mm} = 9.32 \text{ mm} \quad (1)$$

Hence, the dimension  $W$  is:

$$W = 2 \cdot X_1 = 2 \cdot 9.32 \text{ mm} = 18.64 \text{ mm} \quad (2)$$

For a given resolution of the LCD monitor matrix ( $X$  640 pixels, which corresponds to a dimension of 18.64 mm), it can be determined, from the aspect ratio, that the distance between individual pixels is 0.029 mm. Therefore, the actual dimension of the detected surface defect  $L$  represents the distance between the dimensional cursors. This is calculated by multiplying the conversion factor of 0.029 mm/pixel by the number of pixels between the dimensional cursors marked by the diagnostician (vertical and horizontal coordinates), read by the computer from the monitor matrix.

The following measurement options are available in the 'Shadow' method [19]:

- length;
- skew length;
- multi-segment length, broken length (circumference);
- distance of the point from the base line;
- depth (protrusion); and
- diameter of the marked area (using a circular ruler).

A very important diagnostic advantage of the 'Shadow' method is the possibility of immediate resolution of doubts regarding the correct interpretation (unambiguous distinction) of surface defects, resulting in material loss or build-up. Diagnostic problems of this type accompany the assessment of the working spaces' technical conditions within

combustion engines. Due to optical and light effects, the usual contamination of the surface of the air or exhaust passages, in the form of mineral deposits or fuel combustion products (carbon deposits), is often interpreted as corrosive or erosive defects in the structural material. Figure 1 shows that such doubts are easily resolved by the nature of the shadow line deviation observed on the video endoscope monitor. The surface indentation (the greater distance of the speculum head to the surface) is accompanied by a refraction and shift of the

shadow line to the right hand side of the screen, whilst its convexity (its greater approximation to the speculum head) comprises refraction and a shift of the shadow line to the left hand side of the screen. Figure 1a shows an example of the result of measuring the depth of a concave surface profile of a crack in the cylinder surface, made with the Everest XLG3 video endoscope. In turn, for the measurement of the crack length (Fig. 1b) of 4.38 mm, the accuracy index is 12.7, which corresponds to a measurement error of 0.1 mm. The method of determining the accuracy index of the measurements carried out is shown in Fig. 6.

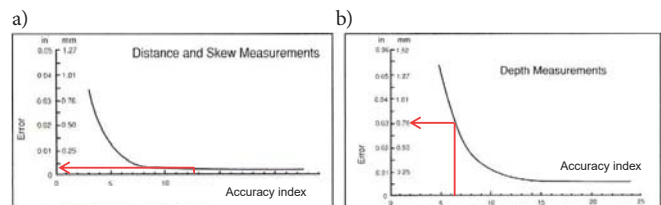

Fig. 6. The method of determining the measurement error from the measurement accuracy index using the 'Shadow' method: a) measurement of the distance and skew length; b) depth measurement (protrusion) [19]

It should also be taken into account that in the 'Shadow' method, the measurement of the depth (protrusion) of the surface profile is only possible along the shadow line generated perpendicular to the tested surface.

The 'shadow' method is particularly characterised by the utilitarian values confirmed in diagnostic examinations of marine engines, as well as high accuracy, which (while maintaining the required measurement conditions) might reach 95% [17]. The most important factor of high measurement accuracy is the maximum approximation of the

speculum head to the tested surface (the shadow line moves to the left as it approaches the surface of the speculum head) and maintaining the position of the speculum head perpendicular to this surface (the shadow line runs perpendicular to the base of the monitor's screen).

## RESULTS AND DISCUSSION

Before the video endoscope can begin recording, the appropriate optical lens on the sight glass head of the inspection probe has to be installed. Two optical lenses are used for engine examinations:

- standard probe XLG3T61120FG type, 6.1 mm in diameter, straight-on observation, 120° field of view and 5-100 mm depth of field;

- measuring ShadowProbe XLG3TM6150FG type, with a diameter of 6.1 mm, straight ahead observation, angle of view 50° and depth of field 12–30 mm.

Each endoscopic examination of the engine begins with a standard lens, while the detected surface defects are identified with a measuring lens. During the examination, special attention should be paid to the condition of the valve heads and seats, as well as the condition of the internal surfaces of the cylinder liner (surface layer), as well as the piston head and bottom. The recorded results (endoscopic images) are related to the reference state of the working space of the research engine fed with MDO fuel, for each test of a new type of low-sulphur marine fuel (Fig. 7). Additionally, a comparative analysis of endoscopic images of the same structural elements of the engine working space is carried out, being recorded immediately before and after the parametric tests of the marine fuel (Fig. 8).



a) Piston head with visible identification number



b) Cylinder sliding surface in the vicinity of BDC – traces of abrasive wear, no traces of the liner 'honing'



c) Piston crown – visible traces of carbon deposits (1) and scratches on the surface (2)

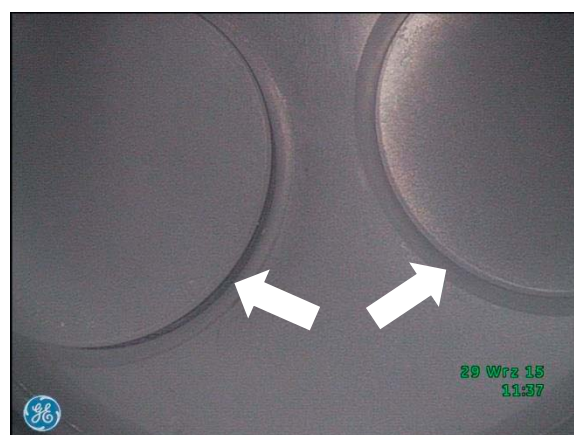

d) Bottom plate of the cylinder head with valve seats





e) Measurement of the scratch length on the piston crown made by the 'Shadow' method – 7.52 mm, with an accuracy index of 4.9, corresponding to an absolute error of 0.3 mm



f) Measurement of the scratch depth on the piston crown made by the 'Shadow' method – 0.35 mm, with an accuracy index of 16.3, corresponding to an absolute error of 0.1 mm

Fig. 7. Endoscopic image of the in-cylinder space of the Farymann Diesel D10 engine fed with MDO standard fuel in the reference condition (a-d) and the results of measurement of surface defects detected on the piston crown (e-f)

As a result of endoscopic examinations of the research engine in the reference condition, the following were found:

- the presence of longitudinal traces of slight abrasive wear of the cylinder liners
- (microslicings, scratchings, ploughings);
- the presence of small surface defects on the piston crown (mainly scratchings);
- slight deposits of impurities (mainly soot) on the bottom plate of the cylinder head, as well
- as on the surfaces of the cylinder's intake and exhaust valve heads.

The quality of the combustion process is reflected in the technical condition of the surfaces limiting the working space of the research engine. For example, as a result of the parametric tests while using low-sulphur MGO distillate fuel, significantly exceeded emissions of unburnt hydrocarbons and carbon monoxide were found. This diagnostic symptom proves its incomplete combustion [5]. Comparing the endoscopic examination results recorded for the engine working space carried out immediately before and after parametric tests,

an increased amount of soot and ash is evident on the piston crown, bottom plate of the cylinder head and valve heads (Fig. 8). These are unambiguous symptoms of an incorrect fuel dose or injection advance angle, which indicate the need for engine adjustment. However, no additional surface defects were detected and earlier traces of abrasive, corrosive and erosive wear identified on the cylinder liner surface (i.e. at the beginning of the research engine operation) were conservative. Interestingly, the working space of the engine was self-cleaned of soot after switching to a different type of low-sulphur residual RMG380 marine fuel, with significantly lower chemical emissivity of exhaust gases [5] (Fig. 9). The registered results of the engine's endoscopic examinations were verified during direct inspection of its working space, after removal of the cylinder head at the end of the whole testing program for all marine fuels, see Fig. 10. The results confirmed the satisfactory technical condition of the engine, without any symptoms of destructive impacts on its structure from any of the tested low-sulphur marine fuels (apart from carbon deposits).

BEFORE THE PARAMETRIC EXAMINATIONS

AFTER THE PARAMETRIC EXAMINATIONS

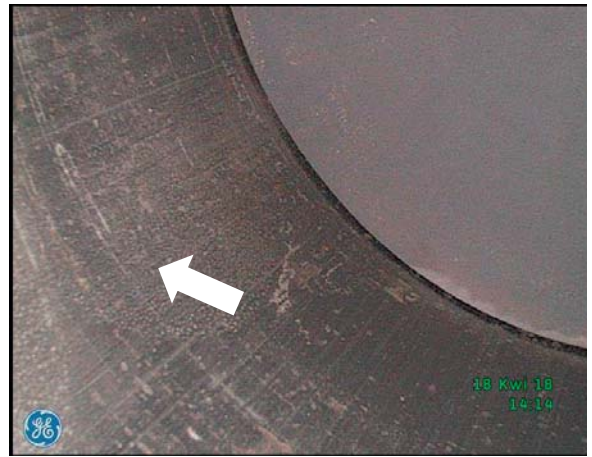

a) Cylinder surface in the lower part of the liner – traces of abrasive and erosive wear, no visible traces of honing of the liner

b) Cylinder surface in the middle part of the liner – traces of abrasive and erosive wear, no visible traces of honing of the liner



c) Piston crown – identification numbers visible

d) Piston crown – thick layer of soot, identification numbers not visible (visible trace after moving the video endoscope probe)

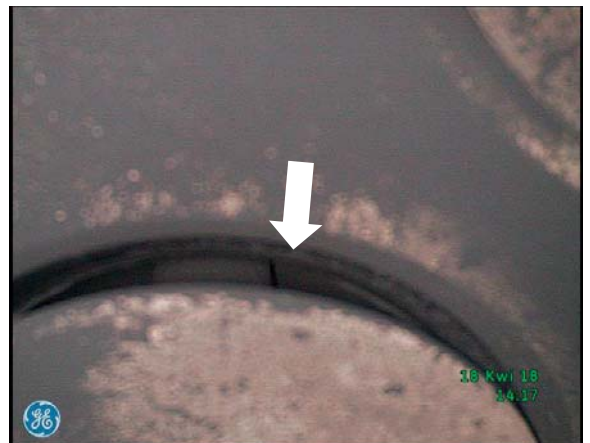

e) Bottom plate of the cylinder head – ajar outlet valve, closed inlet valve

f) ) Bottom plate of the cylinder head – ajar outlet valve, closed inlet valve (magnification), carbon deposits on the valve face



BEFORE THE PARAMETRIC EXAMINATIONS



g) Fuel injector spray tip fitted immediately prior to parametric examinations

AFTER THE PARAMETRIC EXAMINATIONS



h) Fuel injector removed from the cylinder head – thick layer of soot on the spray tip

Fig. 8. Endoscopic image of the cylinder working space (a-l) and view of the fuel injector spray tip (g-h) of the Farymann Diesel D10 research engine before and after parametric examinations in the conditions of feeding MGO type marine fuel



Fig. 9. Endoscopic image of the piston crown of the Farymann Diesel D10 research engine after testing RMG380 type marine fuel – surface clean, free of defects and contamination, identification numbers visible again



Cylinder liner closed by the piston head – clean surface, identification numbers visible



Bottom plate of the cylinder head – closed cylinder valves, a passage connecting the cylinder working space with the combustion pre-chamber, no traces of working medium leakage through the valve faces

Fig. 10. View of the in-cylinder space of the Farymann Diesel D10 engine after removing the cylinder head

## FINAL REMARKS AND CONCLUSIONS

On the basis of the results recorded from the endoscopic examinations of the laboratory diesel engine after the completion of the entire testing program for low-sulphur marine fuels, it can be concluded that the technical condition of the available structural elements limiting its working space is satisfactory. The condition did not undergo significant changes under the influence of changes in the elemental composition of the fuel or the additives used to improve its lubricity. Also, changes in temperature and viscosity, during the implementation of transient processes in particular (e.g. rapid changes in a fuel dose during engine running), did not result in noticeable wear of the surface layers of the available structural elements of the working space. The detected surface defects, in the form of carbon deposits, indicate the need to adjust the fuel dose and the injection advance angle.

## REFERENCES

1. K. Andersson, S. Brynolf, E. Fridell, and M. Magnusson, *Compliance possibilities for the future ECA regulations through the use of abatement technologies or change of fuels*. Transportation Research Part D: Transport and Environment, 2014, 28, pp. 6-18. <https://doi.org/10.1016/j.trd.2013.12.001>.
2. J. Breen and M. Stellingwerff, *Application of optical and digital endoscopy*. Proceedings 2nd EAEA-Conference, Vienna, 1995.
3. J. Hlebowicz, *Industrial endoscopy*. Gamma Office. Warszawa 2000 (in Polish).
4. Z. Korczewski, *Test method for determining the chemical emissions of a marine Diesel engine exhaust in operation*. Polish Maritime Research, 2021, 28, pp. 76-87. <https://doi.org/10.2478/pomr-2021-0035>.
5. Z. Korczewski, *Energy and emission quality ranking of newly produced low-sulphur marine fuels*. Polish Maritime Research, 2022, 29, pp. 77-87. <https://doi.org/10.2478/pomr-2022-0045>.
6. Z. Korczewski, *Methodology of testing marine fuels in real operating conditions of the compression-ignition engine*. Gdańsk University of Technology, PL, 2022 (in Polish).
7. J. Kowalski, *ANN based evaluation of the NOx concentration in the exhaust gas of a marine two-stroke diesel engine*. Polish Maritime Research, 2009, 16, pp. 60-66. <https://doi.org/10.2478/v10012-008-0023-7>.
8. L. Kukielka, D. Woźniak and J. Woźniak, *Endoscopy in automotive technology chosen aspects*. Autobusy, 2015, 6, pp. 292-298.
9. M.I. Lamas, C.G. Rodriguez and J.M. Rebolledo, *Numerical model to study the valve overlap period in the Wartsila 6L 46 four-stroke marine engine*. Polish Maritime Research, 2012, 19, pp. 31-37. <https://doi.org/10.2478/v10012-012-0004-8>.
10. M.I. Lamas and C.G. Rodriguez, *Numerical model to study the combustion process and emissions in the Wartsila 6L 46 four-stroke marine engine*. Polish Maritime Research, 2013, 20, pp. 61-66. <https://doi.org/10.2478/pomr-2013-0017>.
11. M.I. Lamas, C.G. Rodriguez, J. Telmo, and J.D. Rodríguez, *Numerical analysis of emissions from marine engines using alternative fuels*. Polish Maritime Research, 2015, 22, pp. 48-52. <https://doi.org/10.1515/pomr-2015-0070>.
12. M.E. Rainer, *Philipp Bozzini – the father of endoscopy*. Journal of Endourology, 2003, 10, pp. 859-862. <https://doi.org/10.1089/089277903772036145>.
13. C.G. Rodriguez, M.I. Lamas, J.D. Rodríguez, and A. Abbas, *Analysis of the pre-injection system of a marine diesel engine through multiple-criteria decision-making and artificial neural networks*. Polish Maritime Research, 2021, 28, pp. 88-96. <https://doi.org/10.2478/pomr-2021-0051>.
14. N. Zamiatina, *Comparative overview of marine fuel quality on Diesel engine operation*. Procedia Engineering, 2016, 134, pp. 157-164.
15. R. Zhao, L. Xu, X. Su, S. Feng, C. Li, Q. Tan, and Z. Wang, *A numerical and experimental study of marine hydrogen-natural gas-diesel tri-fuel engines*. Polish Maritime Research, 2020, 27, pp. 80-90. <https://doi.org/10.2478/pomr-2020-0068>.
16. Z. Yang, Q. Tan and P. Geng, *Combustion and emissions investigation on low-speed two-stroke marine diesel engine with low sulphur diesel fuel*. Polish Maritime Research, 2019, 26, pp. 153-161. <https://doi.org/10.2478/pomr-2019-0017>.
17. Everest VIT GE. XLG3 VideoProbe measurement system. USA 2011.
18. Europen Motorii Marini srl. The optical fibres industrial endoscopy for marine and industrial engines. Italy 2022.
19. General Electric Company Inspection Technologies. The Everest XLG3 VideoProbe System. Manual Guide. USA 2011.
20. IKA WERKE CALORIMETERS. IKA designed for scientists. IKA-Werke GmbH & Co. KG, Germany 2022.