

Impacts of Using Exhaust Gas Recirculation and Various Amount of Dimethyl Ether Premixed Ratios on Combustion and Emissions on a Dual-Fuel Compression Ignition Engine

Denys Stepanenko¹, Jacek Rudnicki¹, Zbigniew Kneba^{1*}

¹ Faculty of Mechanical Engineering and Ship Technology, Gdansk University of Technology, ul. G. Narutowicza 11/12, 80-233 Gdansk, Poland

* Corresponding author's e-mail: zkneba@pg.edu.pl

ABSTRACT

In the presented research, the authors dealt with the specific properties of the combustion process of dimethyl ether (DME) in a combustion car (Volkswagen Golf IV) engine AJM 1.9 TDI PDE made by Volkswagen factory. Dimethyl ether is an alternative fuel produced most often from natural gas, which can be used in compression ignition engines as a single fuel or co-burned with diesel oil. This work describes the impacts of using exhaust gas recirculation (EGR) system and various diesel to DME substitution ratios from 0% to approximately 25% (on an energy basis), on the combustion process in a dual-fuel diesel engine. The engine has been modified so that DME fuel is introduced into the intake manifold just before the intake valves. The diesel fuel supply system, operation algorithms of the engine electronic control unit and other engine elements were left unchanged as it was built by the manufacturer.

Keywords: dual-fuel diesel engine, DME premixed ratio, internal combustion engine, combustion, emission reduction, alternative fuels.

INTRODUCTION

Given the widespread discussions about new energy sources for vehicles [1], one option is the use of alternative fuels. Some of them can be produced from renewable sources (e.g. biogas), but most of the production is currently based on natural gas [2, 3]. Competitive fuels or energy carriers such as hydrogen or ammonia are too expensive for now [4]. The global demand for energy from fossil liquid fuels that have high energy storage densities is increasing rapidly (Figure 1). Cars include 2- and 3-wheelers. Trucks include most SUV's in North America. Non-road includes aviation, marine and rail of fuels

Fossil fuel resources are limited and will suffice according to the forecasts given in [6] for the next 39 years for oil, 61 years for gas and 216 years for hard coal. Internal combustion engines (ICE) are the main consumer of crude oil and some natural gas, the use of which has

recently been increasing in engines in the energy sector (Figure 2). Hence the interest in fuels that can complement the energy market [7, 8] or be stored long-term without energy input when produced from renewable sources [9]. Another contribution to the research of new fuels is the long-standing need to reduce emissions of toxic and harmful exhaust gas components. Further restrictive regulations in transport and industry are still being discussed. Although the same permissible emission levels have recently been adopted (the planned Euro 7 is the same as the current Euro 6), the testing methods will change, which will force a reduction in harmful emissions. Among various alternative fuels like biodiesel, light alcohol fuels, biomethane, liquefied petroleum gas (LPG), compressed natural gas (CNG), gas-to-liquid (GTL), coal-to-liquid (CTL), and biomass-to-liquid (BTL), dimethyl ether (DME) fuel exhibits the great potential to be an alternative substitute to diesel oil (also called diesel fuel or diesel) as a fuel

Liquids demand

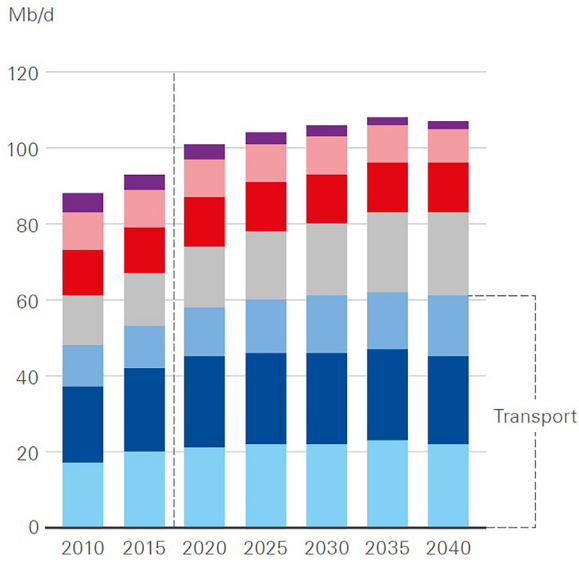

Fig. 1. Liquid fuels demand [5]

for compression ignition engines. DME has some favorable properties compared to diesel oil (DO). More detailed the potential of DME as alternative fuel in a compression ignition engine was described in the previous work [6]. The main parameters of DME and diesel oil are given in Table 1.

With a significantly lower carbon content in DME and a higher cetane number, it has the same hydrogen content as diesel oil. It has a low boiling point and low density. The potential benefit of DME is due to it being a clean fuel with low emission particularly in terms of particulate matter (PM) and soot [11]. Another not at all less important feature of DME, is its capability to blend with a variety of fuels, including diesel, biodiesel,

LPG, and others. Due to the key features above, DME fuel is suitable for powering compression ignition engines in three different operation modes: dual-fuel mode, blended-fuel mode and single-fuel combustion mode. An unfavorable DME feature is its low calorific value which indicates that a larger amount of fuel per cycle must be injected to attain an equivalent level of engine power. The most of experimental and analytical investigations [12–17] on DME-fueled compression ignition engines has been focused on the engines running under blended-fuel mode (DME/DO) or single-fuel combustion mode (DME only).

There are few detailed works [11, 18–21] focused on the combustion and emission processes in the dual-fuel DME/DO engine. In this power supply variant, adapting the engine to use DME is not expensive and the exhaust gas composition with the same operating parameters may be more favorable, but with changes to the parameters of the engine control system [22]. This method of indirect fuel supply is easier to implement and possible when using fuels with a moderate burning speed. Where combustion speeds are high (hydrogen combustion), the authors [23] use direct hydrogen supply to the cylinder and examine the appropriate angle of rotation of the crankshaft for hydrogen supply.

Extensive research has been carried out [6, 11–21] on the use of DME as an alternative fuel for compression ignition engines. These works highlighted the positive impact of replacing diesel fuel with DME on the exhaust gas composition. Table 2 provides brief overview of few a studies and their findings related to the combustion and emission characteristics of the DME-fueled engines.

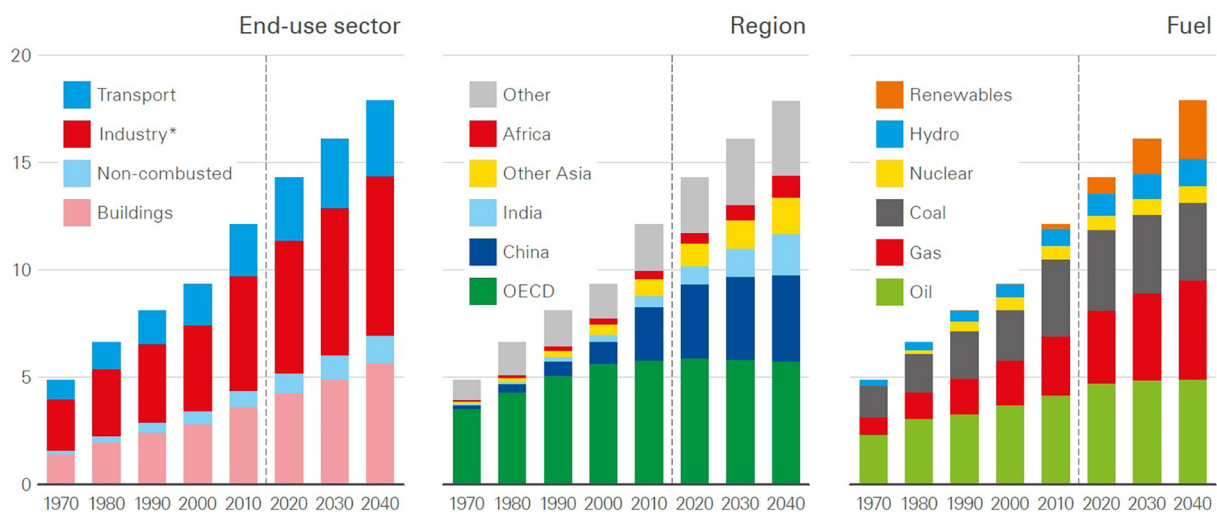

Fig. 2. Primary energy demand [5]. Industry excludes non-combusted use of fuels

Table 1. Properties of DME and diesel oil [6, 10]

Parameter	Units	Diesel oil	Dimethyl ether
Chemical formula	[-]	C _n H _{2n} or C _n H _{2n+2} (n=13–17)	CH ₃ OCH ₃
Molecular weight	[g/mol]	170	46.07
Vapor pressure at 25 °C	(bar)	<0.01	5.1
Boiling temperature	[°C]	125–400	-25
Liquid density at 20 °C	[kg/m ³]	800–840	660
Liquid viscosity at 25 °C	[kg/ms]	2–4	0.12–0.15
Lower heating value	[MJ/kg]	~42.5	28.43
Cetane number	[-]	40–55	55–60
Stoichiometric A/F ratio	[kg/kg]	14.6	9.0
Latent heat of evaporation	[kJ/kg]	250	410
Content of carbon, oxygen and hydrogen	[% by mass]	86/0/14	52.2/34.8/13
Sulfur content	[ppm]	~250	0

Table 2. Brief overview of the studies on the DME-fueled engines

Ref	Fuel type and engine power supply method	Study contents	Results and remarks
[11]	Dual-fuel combustion mode (DME/DO)	Effects of using different ratios of DME/DO on the performance and emissions of a single cylinder compression ignition engine.	A DME concentration of 30% is the optimal level that can enhance both brake specific energy consumption and brake thermal efficiency of the engine. As the quantity of DME increased, there was an associated increase in NO _x , CO, and HC emissions under all engine loads, while black smoke was reduced.
[12]	Single-fuel combustion mode (DME)	Adaptation of the fuel injection strategies to improve the emission and performance characteristics of the DME-fueled engine.	Due to distinguished characteristics of DME from the diesel, the effects of fuel compressibility on compression work spray pattern, atomization characteristics are also compared, which may pave way for maximum exploration of DME as fuel for combustion engine through manipulation of fuel injection strategies.
[13]	Single-fuel (DME) and dual-fuel combustion mode (DME/DO)	Concepts of various low temperature combustion (LTC) engine technologies and their performance and emission characteristics, underlying challenges, and way forward for using DME as a fuel in IC engines.	Low reactivity fuels such as natural gas can be used along with high reactivity fuels such as DME, yielding lower NO _x and PM emissions, reducing heat transfer loss, and increasing engine efficiency.
[18]	Dual-fuel combustion mode (DME and hydrogen)	Performance and emissions of automotive compression ignition (CI) engine fueled with diesel, DME-diesel, and DME-diesel with hydrogen addition under dual-fuel mode at 2200 rpm and varied load conditions (5, 10, 15, and 18 Nm), respectively.	The study shows that hydrogen induction along with DME leads to higher brake thermal efficiency with a drastic reduction in HC, smoke, and CO emissions.
[19]	Dual-fuel combustion mode (DME/DO)	Effects of using different ratios of DME/DO on the performance and emissions of a single cylinder compression ignition engine.	The introduction of DME through port-injection, about 10% of the diesel mass, enhanced the overall performance of the engine. The outcomes indicate a decrease in NO _x levels without NO _x -Soot trade-off, while there is an increase in CO and HC.
[20]	Dual-fuel combustion mode (DME/DO)	Impacts of diesel injection timing and the DME premixed quantity on the performance and emissions of a two-cylinder compression ignition engine.	The maximum value of HRR, in-cylinder pressure and temperature rose with higher DME quantities. At the constant injection timing, up to a certain point an increase in DME dose tends to reduce NO _x and soot emissions, while CO and HC emissions rose. In PCCI combustion mode, late injection resulted in a decrease in NO _x emissions while leading to an increase in smoke, HC, and CO emissions.

The simplest and inexpensive approach to utilize the DME in older diesel engine designs involves adapting them to operate in a dual-fuel combustion mode. The objective of this study is to experimentally evaluate the effects of using exhaust gas recirculation (EGR) and various amount of DME dose (from 0% to approximately 25% on an energy basis) on the combustion process and emission formation in a dual-fuel car (Volkswagen Golf IV) engine AJM 1.9 TDI PDE, made by Volkswagen.

EXPERIMENTAL APPARATUS AND PROCEDURES

The experimental investigations were carried out using a four-stroke, four-cylinder car (Volkswagen Golf IV) engine with direct injection and compression ignition. The engine type is AJM 1.9 TDI PDE from Volkswagen. Technical data of the engine are presented in Table 3.

Tested engine has been properly adapted to work under dual-fuel mode (DO and DME). The engine’s intake manifold was modified by installing additional ports that allow the introduction of the DME. DME is stored in a pressurized tank and it’s flowing rate was controlled by electronic gas control unit (EGCU), while the original diesel fuel supply system was still retained. Diesel oil flow was controlled by the conventional electronic control unit (ECU). In dual-fuel

operational concept, EGCU reads information from lookup tables, referred to as “maps.” Subsequently, it generates a continuous modified signal from sensors (APP, MAF, MAP), which is then transmitted to the diesel ECU. Simultaneously, the EGCU adjusts DME flowing rate. Based on the received modified signals, diesel ECU changes quantity of the fed diesel oil. In more detail dual-fuel ECU working concept was described in the previous work [22]. Additionally, the original air filter was replaced with a laminar flow meter. In order to better control the temperature behind the turbocharger, the intercooler fan was replaced with a water cooler. No more engine modifications or tuning, e.g., diesel injection timing of the pilot dose or injection strategy (single or multiple injections etc.), optimization of the operation algorithms of the conventional electronic control unit etc., were made. During the test with EGR, its rate was controlled automatically by the conventional ECU. This approach allows to, evaluate the influence on the combustion and emissions of the diesel engine that has no optimization for operating on a new alternative fuel, or containing the minimum possible modifications. Note that none of the engine modifications influences the engine operation conditions of the engine nor does it cause any engine running disturbance in the conventional direct injection compression ignition (DICI) operation mode. The test engine was installed on a test rig with hydraulic dynamometer Schenck D450-1. Additionally, conventional

Table 3. The test engine specifications [24]

Parameter	Units	Value
Type	[-]	AJM 1,9 TDI
Manufacturer	[-]	Volkswagen
Primary Fuel	[-]	Diesel oil
Displacement	[cm ³]	1896
Number of cylinders	[-]	4
Number of valves per cylinder	[-]	2
Bore	[mm]	79.5
Stroke	[mm]	95.5
Connecting rod length	[mm]	144
Compression ratio	[-]	18:1
Maximum speed	[rpm]	4000
Rated power	[kW]	85
Maximum torque at 1900 rpm	[Nm]	285
Injection type	[-]	Direct injection
Diesel oil injector type	[-]	Pump and nozzle unit
Gas fuel injector type	[-]	4-cylinder LPG/CNG injection rail BARRACUDA

ECU was connected to a test rig control unit, allowing simple adjustment of the engine’s speed and torque to the required level through a control software. Figure 3 illustrates schematic diagram of the test bench.

The combustion performance data are acquired by:

1. The in-cylinder fiber optic-based pressure sensor AutoPSI-S made by OPTRAND.
2. The crank angle sensor CKQH-58 made by LIKA.

3. The data acquisition system (DAQ) board USB-6212 made by National Instruments (data was acquired at a sample frequency for each OP, calculated according to the Nyquist–Shannon sampling theorem, see Table 4).
4. NI LabVIEW 2020 software.

An electronic balance made by AWO company was used to measure the consumption of DME. Diesel fuel consumption was obtained from the engine’s Electronic Control Unit (ECU)

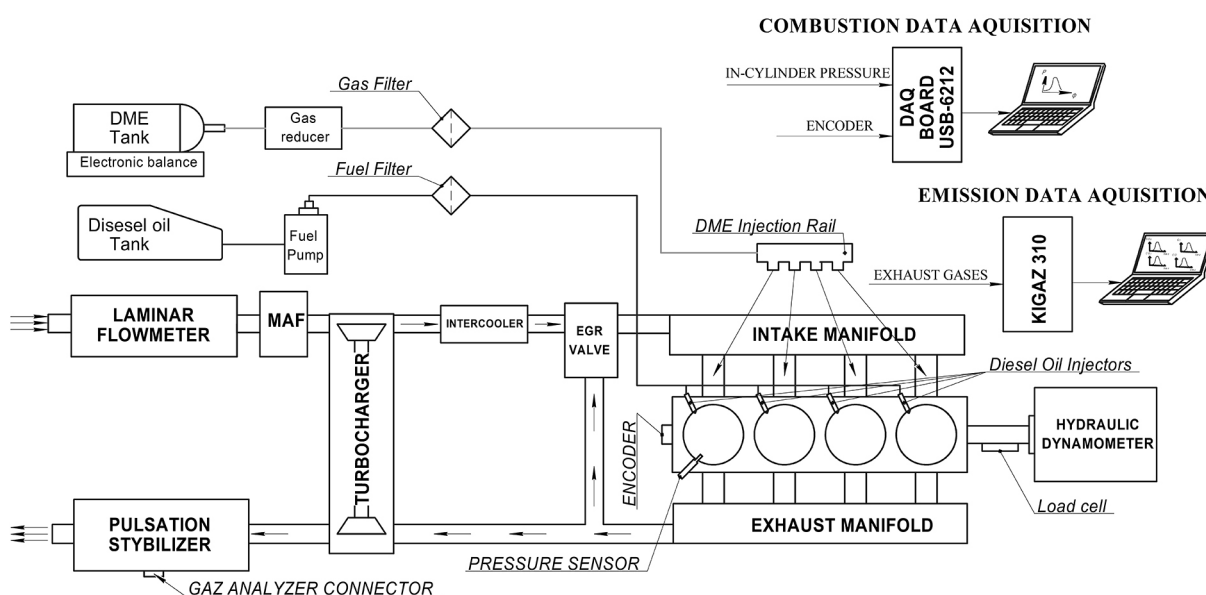

Fig. 3. The schematic block diagram of the experimental equipment

Table 4. Experimental matrix

OP.	No	Engine speed	Engine torque	DO rate with ERG	DO rate without ERG	DME rate	Substitution ratio with ERG	Substitution ratio without ERG	Sampling frequency
-	-	[rpm]	[N*m]	[mg/cycle]	[mg/cycle]	[mg/cycle]	[%]	[%]	[kHz]
1	1	1690	71	18.7	19.52	0	0	0	92
	2			16.5	17.7	2.4	8.87	8.32	
	3			14.8	15.95	4.7	17.52	16.47	
	4			14.5	15.7	5.55*	20.38	19.12	
2	1	1726	91	22.2	22.44	0	0	0	94
	2			19.2	20.39	2.85	9.03	8.55	
	3			17.8	18.63	6.14	18.75	18.06	
	4			17.6	18.23	7.07*	21.18	20.6	
3	1	2280	145	30.5	31.12	0	0	0	124
	2			27.2	27.8	5.57	12.05	11.82	
	3			25.5	25.95	8.64	18.48	18.22	
	4			23.6	24.6	12.05*	25.46	24.68	

Note: that the maximum DME dose aligns with the highest acceptable threshold where the engine with EGR can run without noticeable jerks.

data. Gaseous emissions such as nitrogen (NO_x), carbon monoxide (CO), carbon dioxide (CO_2) and oxygen (O_2) were measured and acquired by gas analyzer KIGAZ-310 made by KIMO.

To assess the effects of using EGR and various amount DME premixed ratios (from 0% to approximately 25% on an energy basis see Eq.1) on combustion and emissions, three operating points (OP) were selected among the collection of steady state operating points. These points reproduce the harmonized test procedure called Worldwide Harmonized Light Vehicles Test Procedure (WLTP). Estimation of the most representative engine operation points during WLTP that the vehicle (Volkswagen Golf IV) with this type of engine must follow, have already been described in previous work [24]. In summary, a computer simulation with a simple longitudinal dynamics approach, along with WLTP gear-shifting rules and a density-based grid clustering method. The objective of the simulation was to identify a set of steady-state operating points that represents the engine's operation during the Worldwide Harmonized Light Vehicles Test Cycles (WLTC) 3b test scenario for an unmodified Volkswagen Golf IV equipped with the AJM 1.9 TDI engine. WLTC 3b test scenario comprises four driving phases: including four driving phases: urban driving (low), suburban driving (medium), extra-urban driving (high), and a highway zone (extra high) for an unmodified vehicle Volkswagen Golf IV equipped with the AJM 1.9 TDI engine. In each OP tests were carried out with four different DME premixed ratios, which are marked as OP.1.1– OP.3.4 (where first digit is operation point OP.1 – OP. 3, the second one is experiment number No.1 – No.4 (Table 4).

The proportion of premixed gas in the blended fuel on an energy basis was calculated using the following formula:

$$SR = \frac{\dot{m}_G \times LHV_G}{\dot{m}_D \times LHV_D + \dot{m}_G \times LHV_G} \times 100\% \quad (1)$$

where: SR – substitution ratio.

Changing the composition of the fuel mixture leads to a change in the air-fuel ratio (λ). In order to ensure the similar engine performance and comparability of the measurements, for both single- and dual-fuel mode air/fuel ratio (λ) was maintained under similar level [22] (This was performed by changing the parameters of the turbocharger). The air/fuel ratio (λ) in the dual-fuel mode should be reduced due to lower stoichiometric air/fuel ratio of DME (Table 1). The

modern exhaust treatment systems work properly only with very narrow field of λ tolerance. Usually, lowering λ by 10% is possible for better economy without compromising the performance of the exhaust after-treatment system. The air/fuel ratio (λ) in this study was calculated using the equation proposed by the exhaust gas analyzer KIGAZ 310, manufactured by KIMO:

$$\lambda = \frac{21}{21+O_2} \quad (2) \quad [25]$$

The initial tests have been conducted in a single-fuel mode only with DO and then additional tests were performed in a dual-fuel mode with DME and DO at the same OP.

Experimental data processing

In this study, in order to reduce the noise and uncertainty of all sensor readings, a set of 150 consecutive cycles at each OP was averaged and smoothed with a Gaussian filter. These preprocessed in-cylinder pressure (p) traces were used to compute the combustion characteristics, such as gross mean effective pressure (GMEP), net heat release rate (NHRR), mass fraction burned (MFB), CD_{10-90} , P_{max} (maxim in-cylinder pressure), ϕ_{max} (crank angle position where pmax appeared) and the location of MFB_0 , MFB_{10} , MFB_{50} and MFB_{90} . The GMEP in this study was calculated using the following formula:

$$GMEP = \frac{\sum_{i=-180CA}^{i=180CA} \frac{(p_1+p_2)}{2} dV}{V_d} \quad (3)$$

The net (apparent) heat release rate (NHRR) was calculated from the Krieger and Borman [26] equation that combined the first law of thermodynamics for a closed system and the ideal gas law, using the formula below:

$$\frac{dQ_{net}}{d\phi} = \frac{\gamma}{\gamma-1} \cdot p \frac{dV}{d\phi} + \frac{1}{\gamma-1} \cdot V \frac{dp}{d\phi} \left[\frac{J}{deg} \right] \quad (4)$$

where: Q_{net} – total amount of in-cylinder net heat release, ϕ – crank angle, V – in-cylinder volume.

The specific heat ratio is related to the pressure and volume, and can be obtained from the following equation:

$$\gamma = \frac{c_p}{c_v} \quad (5)$$

The specific heat at constant pressure (c_p) is a function of temperature and can be obtained by using the polynomial tables of JANAF and the equation proposed by NASA:

$$c_{p_i}(T) = R \cdot (a_1 + a_2T + a_3T^2 + a_4T^3 + a_5T^4) \left[\frac{J}{K \cdot mol} \right] \quad (6)[27]$$

where: a_1 – a_7 – JANAF polynomial coefficients.

The in-cylinder mean gas temperature was obtained using the equation of state for ideal gas, using this formula:

$$T = \frac{p \cdot V}{m \cdot R} [K] \quad (7)$$

The specific heat for a given gas at constant volume and constant pressure volume are related to the gas constant, in the following manner:

$$c_v = c_p - R \left[\frac{J}{K \cdot mol} \right] \quad (8)$$

where: c_v – specific heat at constant volume, R – universal gas constant.

The instantaneous volume of the cylinder is related to the kinematic of crankshaft and relies to the piston position (Figure 4). The general expression can be written as follows:

$$V(\phi) = V_c + \frac{\pi B^2}{4} \cdot (l + a - s(\phi)) [m^3] \quad (9)$$

where: V_c – combustion chamber volume, B – cylinder bore, l – connecting rod length.

The combustion chamber volume was expressed as:

$$V_c = \frac{V}{\varepsilon_s - 1} [m^3] \quad (10)$$

where: ε_s – engine compression ratio.

The instantaneous piston position was expressed as:

$$s(\phi) = a \cdot \cos(\phi) + \sqrt{(l - a \cdot \sin(\phi))^2} [m] \quad (11)$$

where: s – instantaneous piston position.

The cumulative heat release rate was finally given by the following equation:

$$Q_c(\phi) = \int_{IVC}^{EVO} \left(\frac{dQ_{net}}{d\phi} \right) d\phi [J] \quad (12)$$

where: IVC – intake valve closing, ϕ – crank angle.

The mass fraction burned (MFB) at any crank angle with the assumption that it is proportional to the cumulative heat release, was calculated with the following formula:

$$MFB = \frac{Q_{sk}(\phi)}{\max(Q_{sk}(\phi))} \quad (13)$$

where: Q_{sk} – cumulative heat release.

Most of the literature and software to a lower or higher extent ignore the early or last stages

of combustion [28]. In the early and last stages, the combustion process is unstable and the signal-to-noise ratio of the in-cylinder pressure is markedly larger than that in the middle stage [28]. Therefore, in order to get a good prediction of the combustion duration (CD), it was defined as the phase difference between MFB_{10} and MFB_{90} . Thus, in this work combustion duration is estimated as the crank angle interval from MFB_{10} to MFB_{90} . Combustion duration was simply recalculated from crank angle degrees to milliseconds, as follows:

$$CD_{ms} = \frac{CD_{deg}}{n \times 0.006} [ms] \quad (14)$$

where: n – is engine revolutions in rev/min.

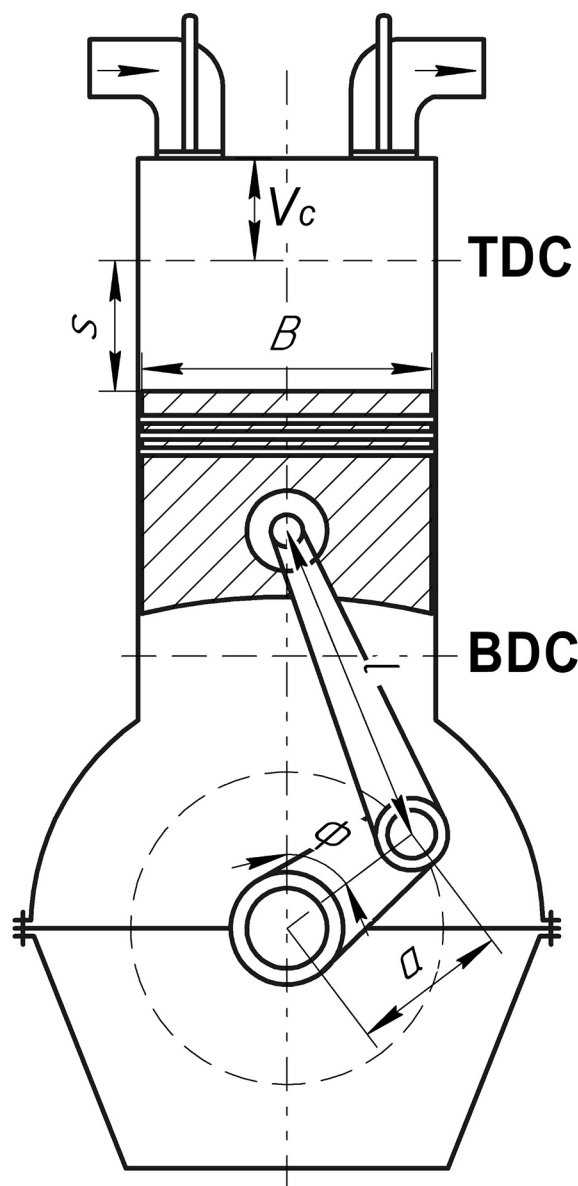

Fig. 4. Schematic diagram of the crankshaft mechanism

The GMEP, CD_{10-90} and location of MFB_0 , MFB_{10} , MFB_{50} and MFB_{90} for all operations points is specified in Table 5.

RESULTS AND DISCUSSION

Two subsections explain the results of the present experimental research. The first subsection discusses the effect of using EGR and various amount of DME premixed ratios on the combustion characteristics at different operating modes: single fuel mode (DO only) and dual-fuel mode (DME and DO). Both of these operation modes during the tests had two conditions with and without EGR. The second subsection explains the influences of the experimental conditions on the engine emissions.

Combustion characteristics

In the DME/DO dual-fuel mode of premixed charge compression ignition (PCCI) engine, there were two additional peaks in the heat release rate curve [21]. The in-cylinder pressure traces and net heat release rate of the present research

are illustrated in Figure 5 – Figure 7. It can be noted that all heat release rate curves with DME injection with/without EGR have two additional peaks (PCCI), compared to a classic diesel heat release process with one peak (DICI). The first peak shows the effect of an early start of fuel mixture combustion at ~30–34 deg before top dead center (TDC) due to DME injection. This peak represents low-temperature reaction/combustion (LTR) caused by the DME high cetane number, low boiling temperature and relatively low auto-ignition temperature. However, the amount of DME premixing ratio has a minor effect on the start (MFB_0 is defined as the crank angle at which 0.001% of the mass fraction burned) of the LTR phase but increases the amount of released energy and the intensity of a given phase. This feature, where the position of LTR remains relatively constant across various premixing fuel ratios, was also noted by other authors [19, 20]. The second peak shows the effect of the high-temperature reaction/combustion (HTR). This combustion phase was perhaps caused by the combustion of the overlapped DME/air mixture that is incompletely burned in LTR phase and in-cylinder diesel spray from the pre-injection. In a

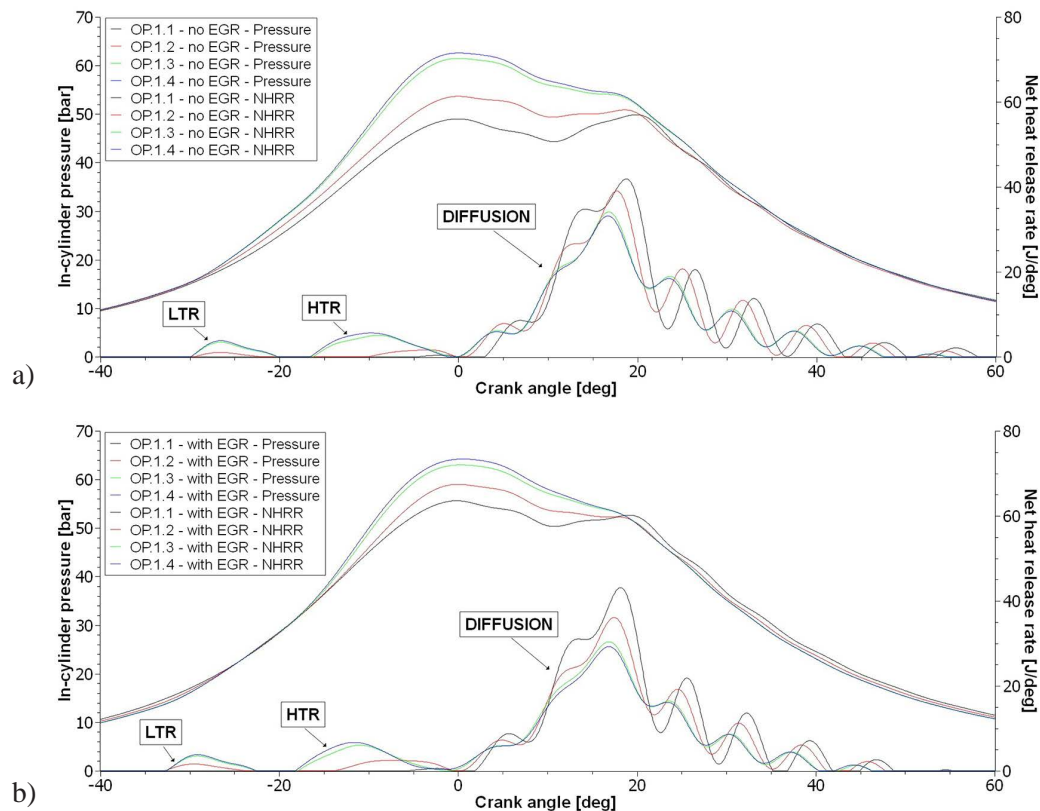

Fig. 5. In-cylinder pressure and net heat release rate variations for OP.1; (a) operation point without EGR, (b) operation point with EGR

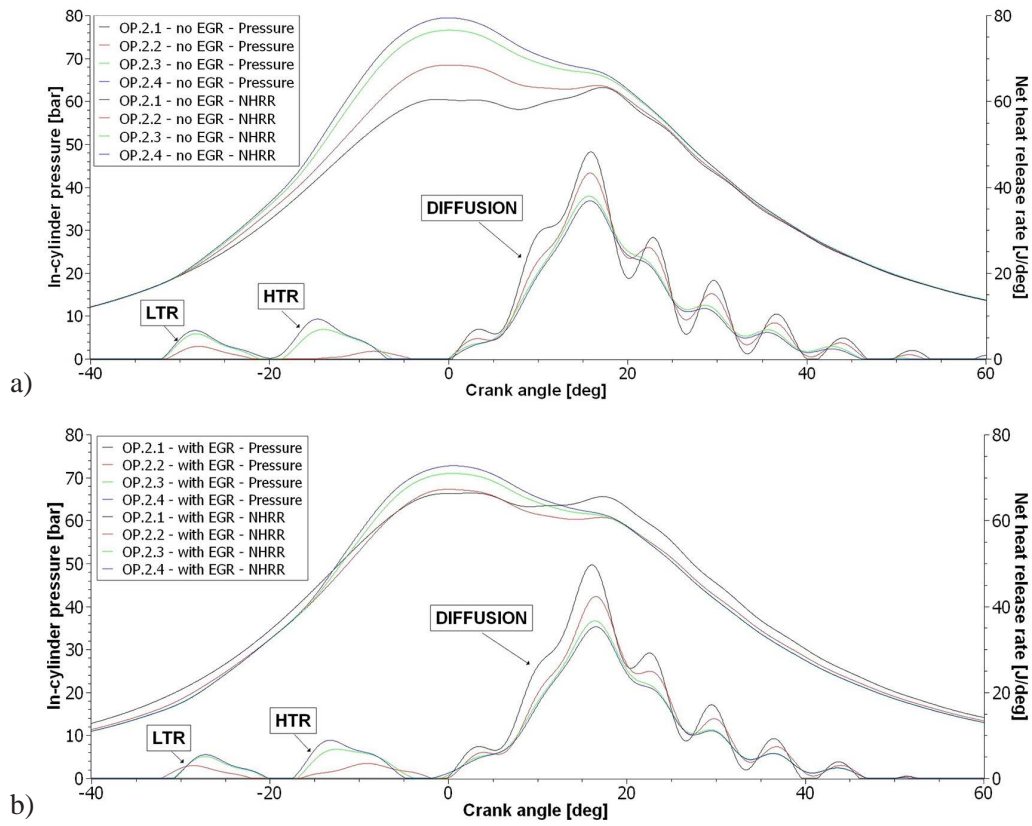

Fig. 6. In-cylinder pressure and net heat release rate variations for OP.2; (a) operation point without EGR, (b) – operation point with EGR

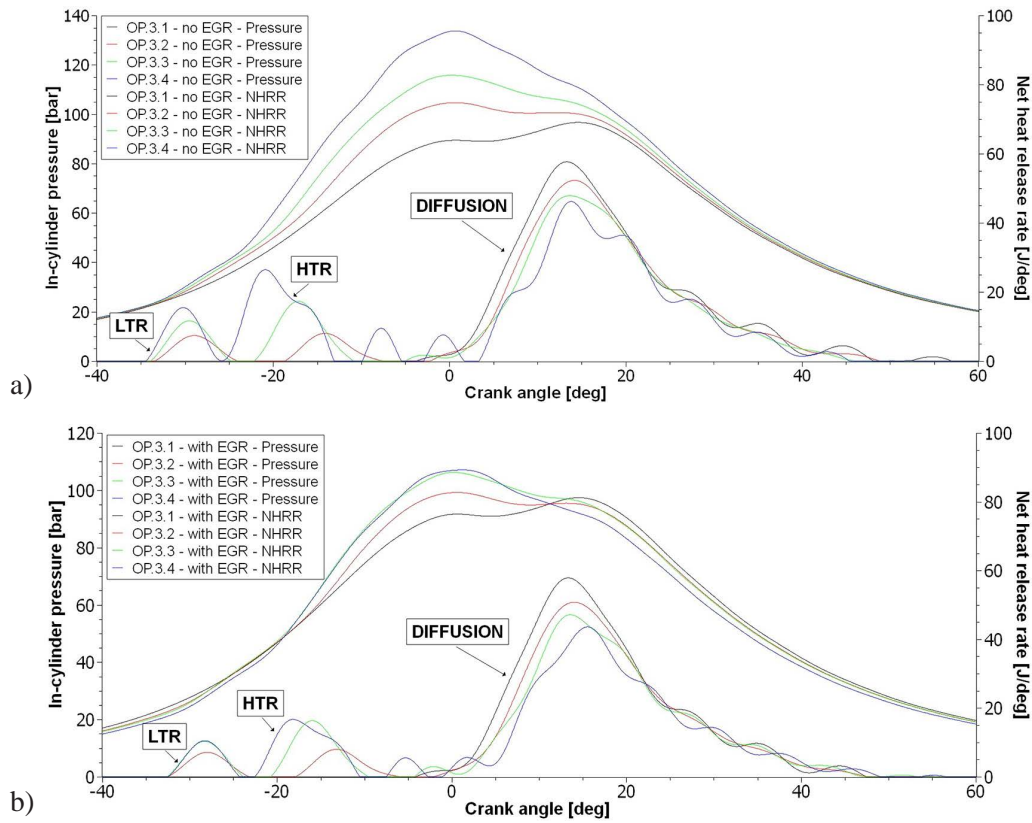

Fig. 7. In-cylinder pressure and net heat release rate variations for OP.3; (a) operation point without EGR, (b) operation point with EGR

similar trend to the one observed in LTR, DME ratio has a great impact on the amount of energy released in HTR phase. Due to raises of the in-cylinder pressure and temperature caused by the increased amount of DME premixed ratio under PCCI combustion mode, the ignition delay of the HTR phase decreases. Finally, the third peak was caused by the diffusion combustion of diesel oil and residual parts of the fuel mixture unburned in the previous phases. With an increase in DME premixing quantity, the diesel oil dose was simultaneously reduced, thus resulting in the decrease in the energy release in diffusion phase. Thus, PCCI combustion mode with DME as premixing fuel, compared to a conventional DICl mode, demonstrated the higher in-cylinder pressure and temperature (Figure 8 – Figure 10) traces for all tested operation points. Moreover, because of the three-stage combustion the crank angle position ϕ_{max} of maximum peak pressure p_{max} appeared to be more advanced, compared to a conventional single stage DICl combustion (Table 4).

From Figure 7 it was also observed that under the maximum DME premixed ratio (OP.3.4), in both modes with and without EGR, the net heat release curve has a more complicated shape. This could be

attributed to the unstable and incomplete combustion due to unoptimized engine operating conditions. After the comparison of operation points with each other with and without EGR, it can be noted that in-cylinder pressure, temperature and consequently, the amount of energy released during combustion is higher for the operation mode with EGR. The above results may be attributed to an integrated effect of multiple factors i.e., properties of the tested fuels, fuel–air mixture formation, EGR and the combustion quality. As the load increased, the temperature of the cylinder wall and the amount of residual gas increased [20]. A higher cylinder wall temperature and a higher amount of residual gas can result in a higher mixture temperature in the next cycle [20]. In addition, due to the bad and/or incomplete combustion of the charge, certain part of the unburned charge retained in EGR is being returned in the following cycle.

The variation of the mass fraction burn rate are illustrated in Figure 11 – Figure 13. The MFB_{10} , MFB_{50} and MFB_{90} were defined as the crank angle at which 10%, 50% and 90% of the mass fraction burned. As mentioned earlier, DME injection yields the divergence from conventional diesel DICl combustion into relatively complex

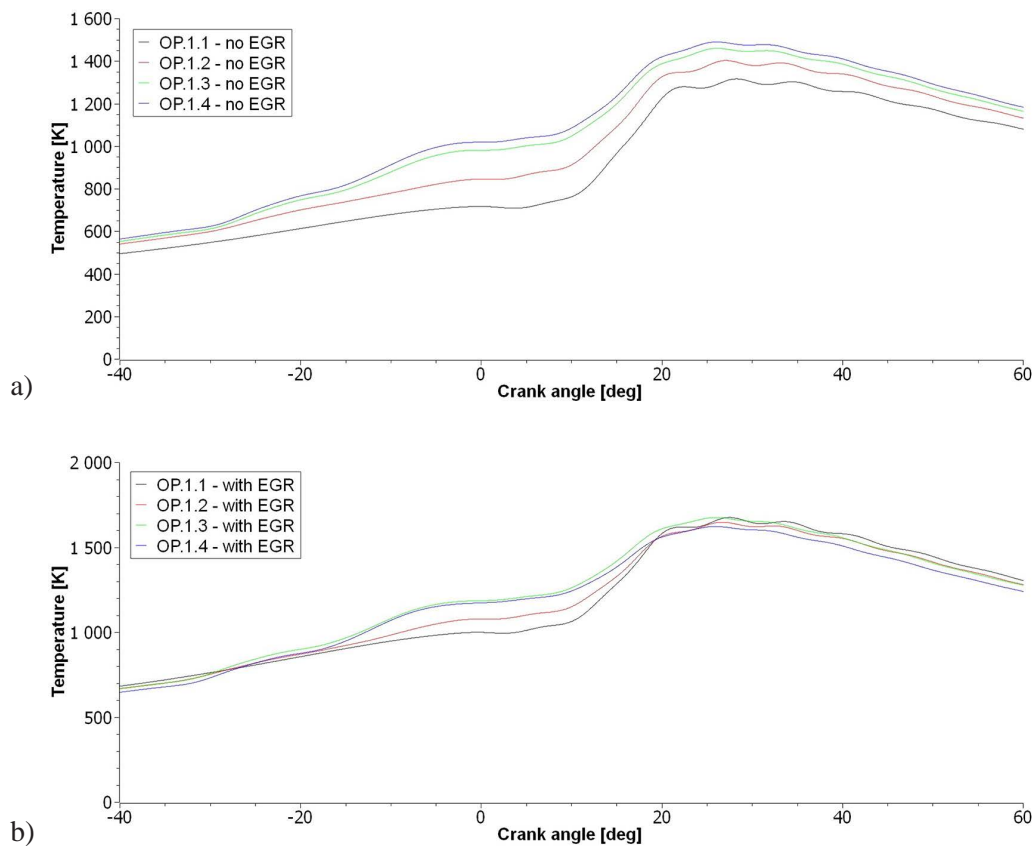

Fig. 8. Temperature variations for OP.1; (a) operation point without EGR, (b) operation point with EGR

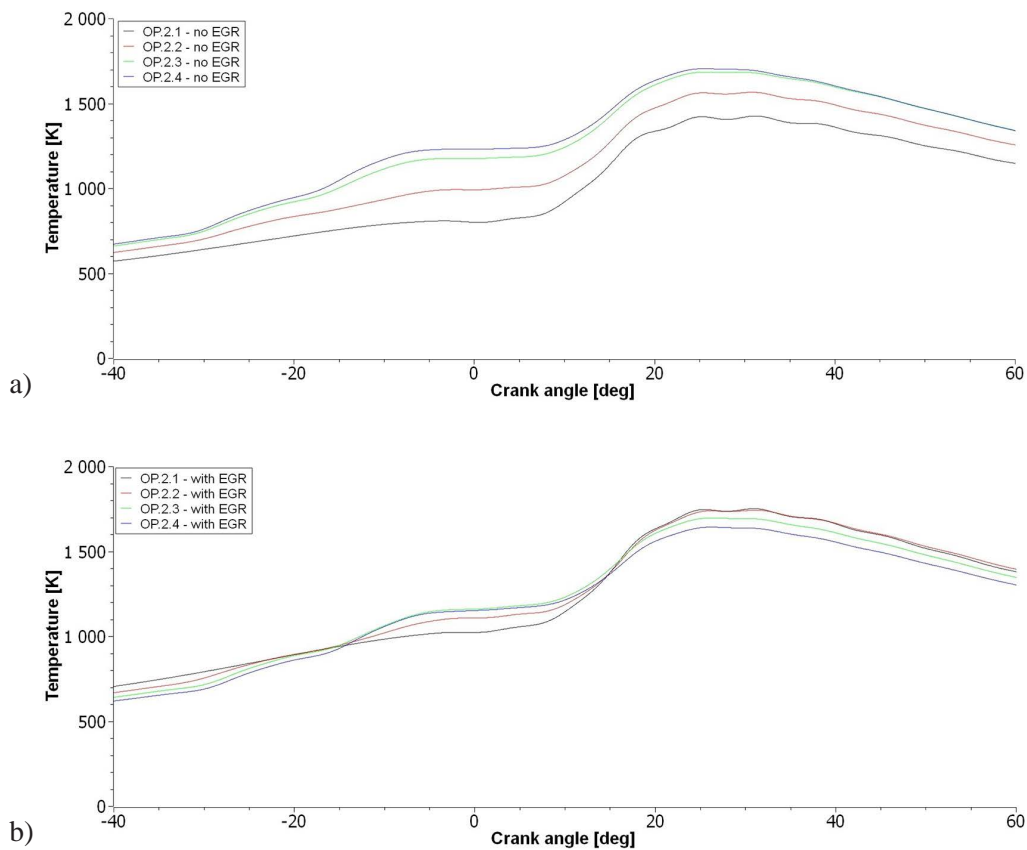

Fig. 9. Temperature variations for OP.2; (a) operation point without EGR, (b) operation point with EGR

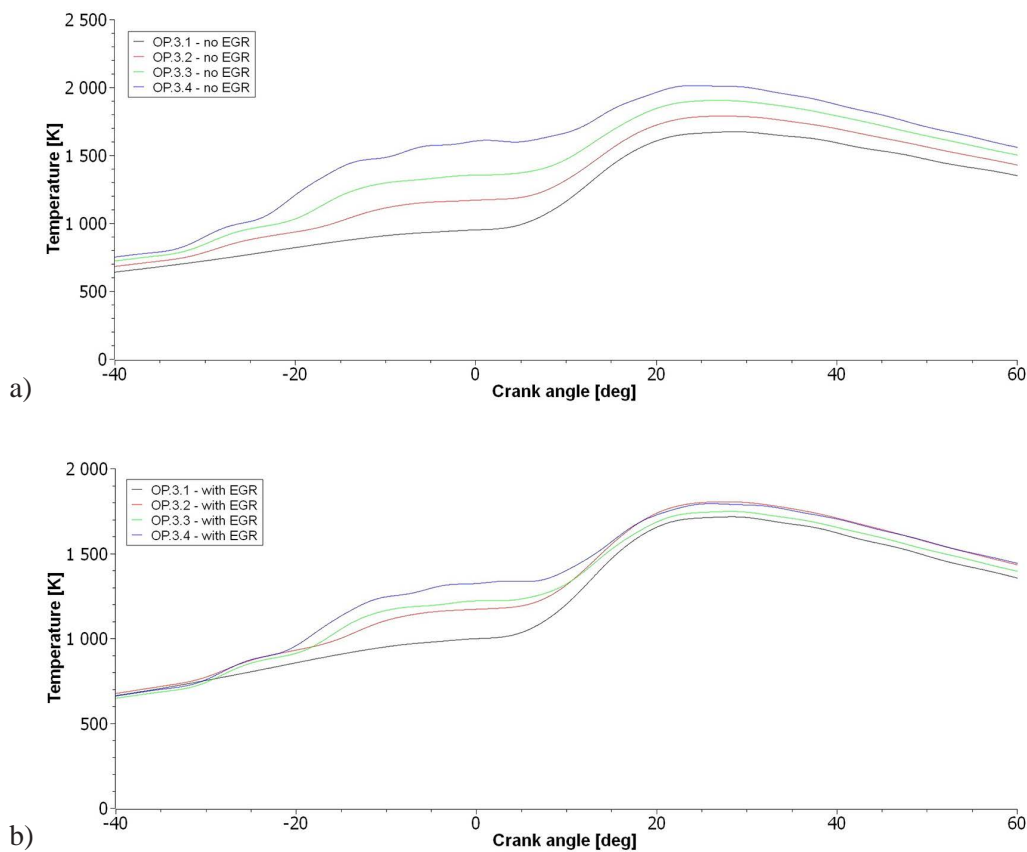

Fig. 10. Temperature variations for OP.3; (a) operation point without EGR, (b) operation point with EGR

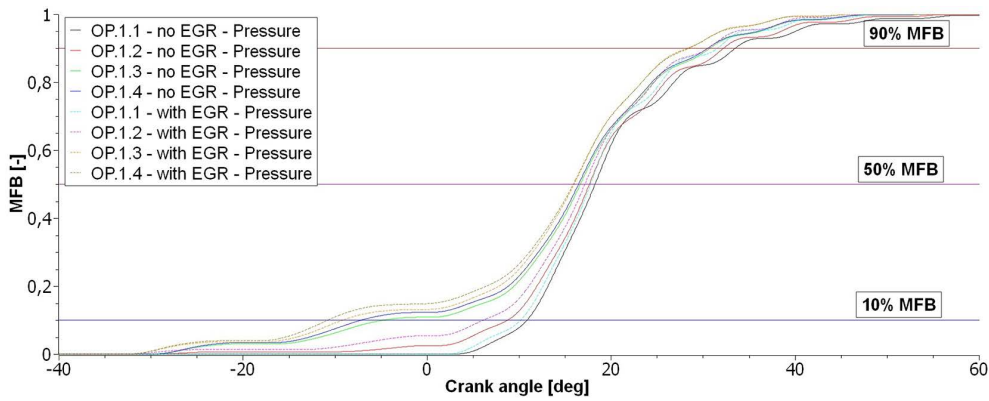

Fig. 11. MFB variations for OP.1

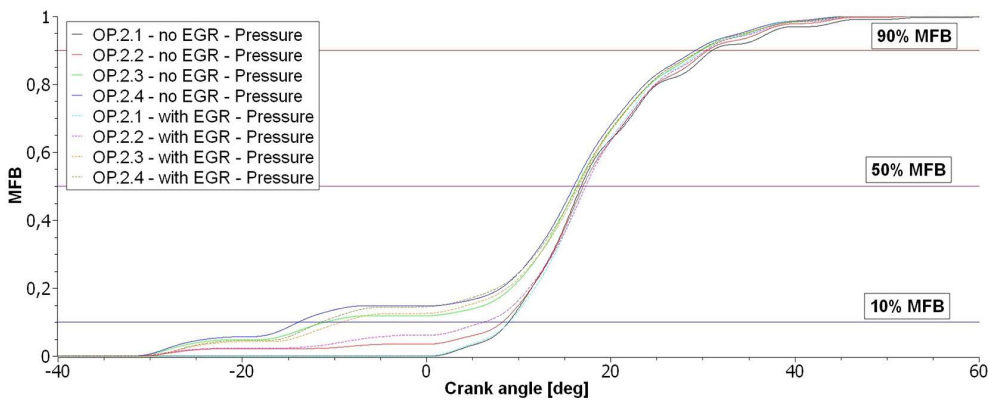

Fig. 12. MFB variations for OP.2

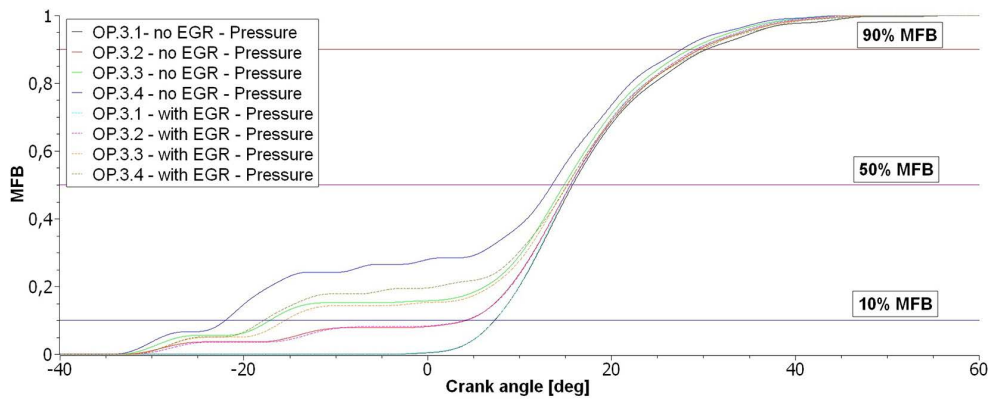

Fig. 13. MFB variations for OP.3

PCCI combustion. In each stage, a certain part of the charge is burned. It is worth noting that the amount of DME premixed ratio has a great impact on the phase between the first heat release stage and the second heat release stage and that this phase shortens distinctly as the DME pilot quantity increases [29]. In addition, compared to DICI mode, an increase in DME premixing quantity in PCCI mode, changes the amount of fuel burned at each stage, thus all

results in location of the MFB_{10} , MFB_{50} and MFB_{90} that appeared gradually advanced. Consequently, the combustion duration is longer in PCCI mode, compared to DICI, which can be clearly seen in Table 5. Due to the lower calorific value of DME (compared to diesel oil), achieving identical torque and power output at each tested operation point results in an increase in brake specific fuel consumption (BSFC), as illustrated in Figure 14.

Table 5. The combustion characteristics calculation results

OP.	No	GMEP	p_{max}	$\phi_{p,max}$	MFB ₀	MFB ₁₀	MFB ₅₀	MFB ₉₀	CD _{deg}	CD _{ms}
		[bar]	[bar]	[deg]	[deg]	[deg]	[deg]	[deg]	[deg]	[ms]
1	1*	6.426087	49.85955	19.85	3.222	10.885	18.275	33.506	22.621	2.2309
	1	6.01632	55.60832	-0.2	2.153	10.194	17.791	31.558	21.364	2.1069
	2*	6.210013	53.64605	-0.05	-28.885	8.79	17.66	32.223	23.433	2.3109
	2	5.814699	58.99023	0	-32.343	6.138	17.173	30.558	24.42	2.4083
	3*	6.383418	61.45215	-0.05	-29.529	-4.654	16.679	30.743	35.397	3.4908
	3	5.659292	62.99106	0.3	-32.289	-9.146	16	28.3	37.446	3.6929
	4*	6.372063	62.56239	0	-29.549	-7.128	16.485	30.508	37.636	3.7116
	4	5.649625	64.19622	0.5	-32.265	-10.759	15.909	28.462	39.221	3.8679
2	1*	7.427218	63.21137	17.2	0.681	8.942	16.8	31.05	22.108	2.1348
	1 z	7.629841	66.38851	2.7	0.161	9.009	17.086	29.892	20.883	2.0165
	2*	7.422294	68.41622	0.05	-31.042	8.27	17.027	30.559	22.289	2.1523
	2	7.41856	67.24322	0	-31.705	6.241	17.31	30.35	24.109	2.328
	3*	7.516081	76.55427	0.1	-31.558	-10.924	16.341	29.844	40.768	3.9367
	3 z	7.277935	70.94529	0.5	-30.464	-9.186	16.573	29.751	38.937	3.7598
	4*	7.367291	79.43769	0	-31.666	-13.872	16.021	29.23	43.102	4.162
	4	7.265899	72.74229	0.6	-30.354	-11.377	16.415	29.736	41.113	3.97
3	1*	11.71556	96.65002	14.6	-3.225	7.321	15.796	30.368	23.047	1.6847
	1	11.4591	97.39741	14.5	-3.632	7.345	15.587	29.127	21.782	1.5923
	2*	11.5961	104.6768	0.7	-32.954	4.242	15.572	29.633	25.391	1.8561
	2	11.20679	99.2114	0.6	-32.034	4.062	15.543	29.262	25.2	1.8421
	3*	11.48057	115.778	0.25	-33.522	-17.129	14.871	28.562	45.691	3.34
	3	11.09827	106.2174	0.2	-32.186	-15.487	15.187	29.44	44.927	3.2841
	4*	11.45328	133.741	0.7	-34.077	-21.975	13.549	27.658	49.633	3.6281
	4	10.59629	107.0954	1.2	-32.105	-17.797	15.245	30.073	47.87	3.4993

Note: operation point without EGR.

Exhaust gas emission

Figure 15 illustrates the impact of using EGR and different DME premixed quantity on NO_x emissions. It is obvious that the main reason for

NO_x formation is the combustion of hydrocarbon fuels under high temperature and pressure conditions. EGR strategy is a proven solution used all over the world to suppress NO_x formation. In this process, exhaust gases are reintroduced into the

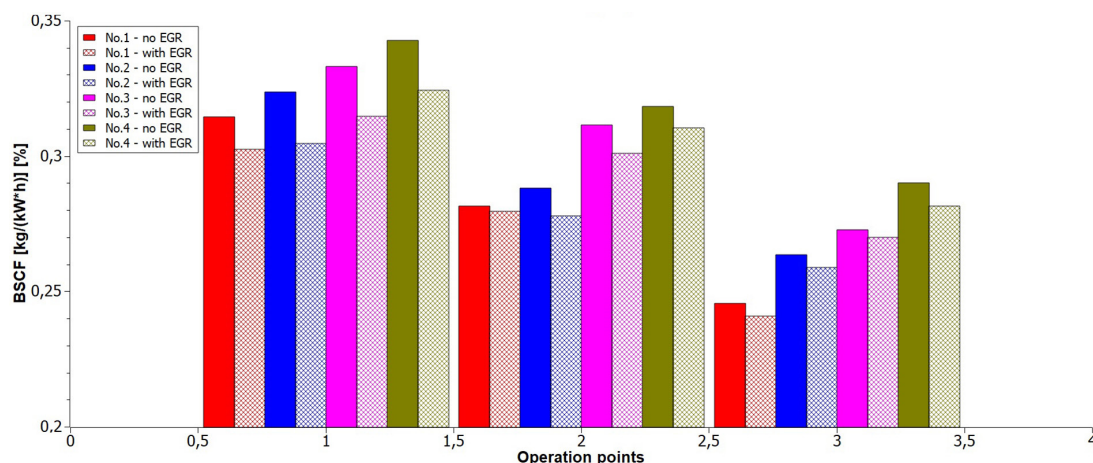

Fig. 14. Effect of DME dose on BSFC

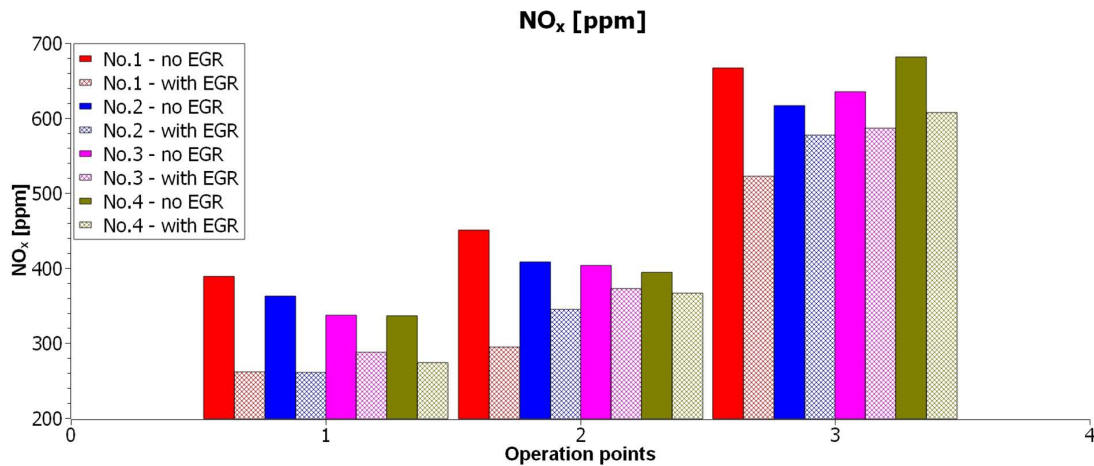

Fig. 15. The effects of using EGR and various DME premixed quantities on NO_x emission

engine’s intake manifold and diluting the fresh air. This dilution enhances the fuel-air mixture heat capacity, reduces the amount of oxygen and consequently reduces the temperature rise during combustion. It is obvious that operation points with EGR show greater reduction in NO_x formation. However, an increase in DME premixing quantity in OP with EGR gradually increases NO_x, while in OP without EGR an increase in DME quantity inhibits NO_x formation or maintains it on similar level. The above results can be explained in the following way:

1. An increase of DME quantity simultaneously decreased the quantity of fed diesel oil.
2. The higher latent heat value of DME resulted in heat absorption during DME vaporization. Consequently, an increase in DME quantity simultaneously increased temperature drop within the combustion chamber which reduced NO_x in OP with EGR.

3. PCCI combustion leads to higher in-cylinder pressure and temperature, compared to DICI mode.
4. Unoptimized PCCI combustion leads to unstable work and jerking of the and, consequently results in deterioration of the combustion and mixture formation. Moreover, due to EGR certain amount of the unburned charge is being reintroduced into the cylinder in the following cycle.

CO is an intermediate product of incomplete combustion of the hydrocarbon based fuels. Formation of the CO in the combustion chamber is facilitated to a limited amount of oxygen, non-optimum air/fuel mixture, excess of exhaust gases in the combustion chamber and the presence of carbon deposits, originated from incomplete combustion of the air/fuel mixture in the gap between the cylinder wall and the piston ring. The variations of CO emissions are shown in Figure 16. It can be noted that with a rise of DME, the quantity

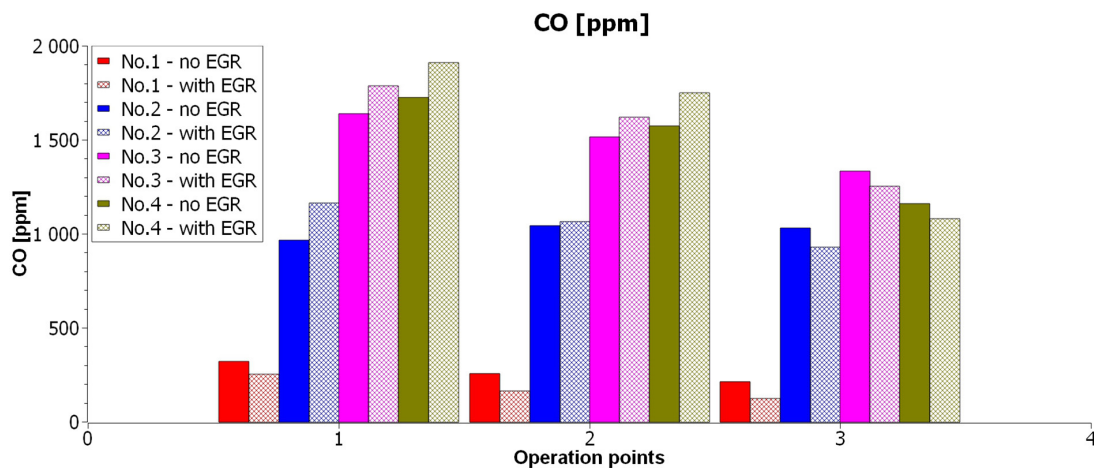

Fig. 16. The effects of using EGR and various DME premixed quantities on CO emission

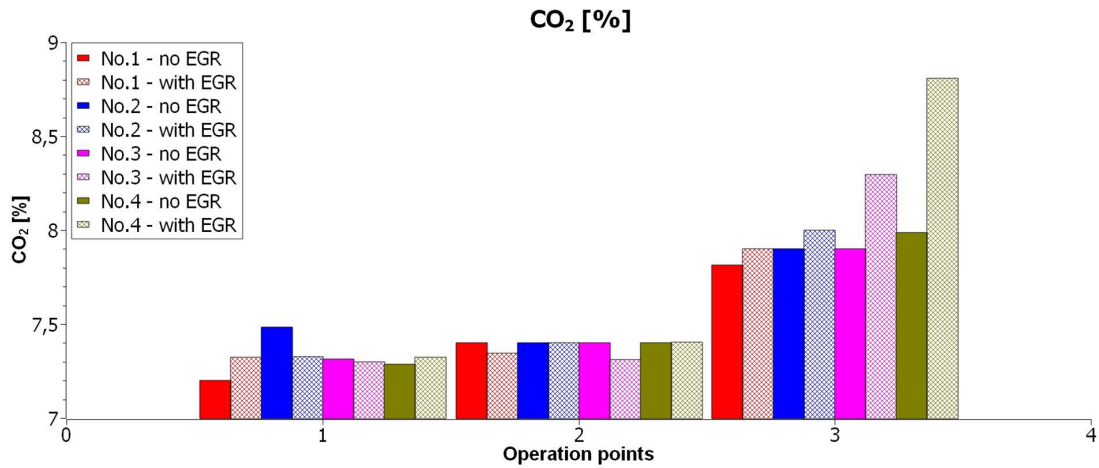

Fig. 17. The effects of using EGR and various DME premixed quantities on CO₂ emission

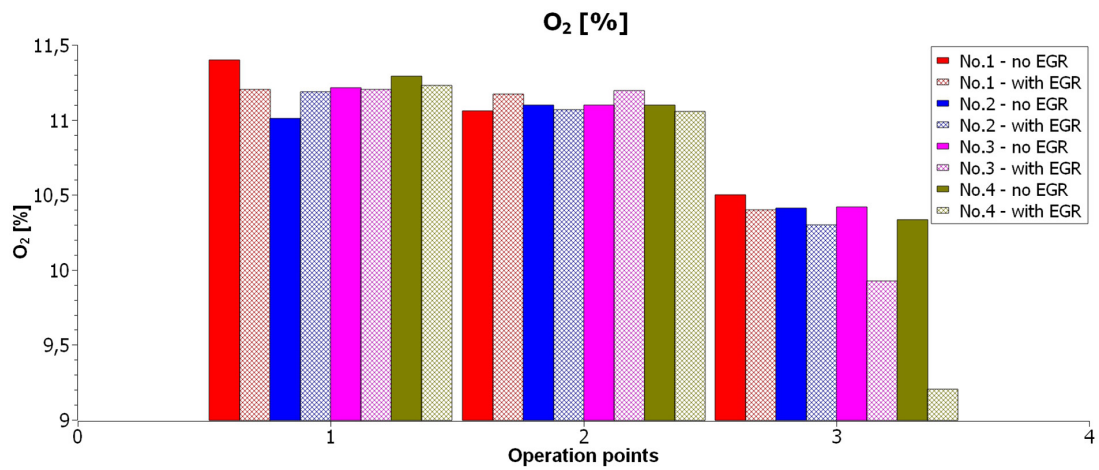

Fig. 18. The effects of using EGR and various DME premixed quantities on O₂ emission

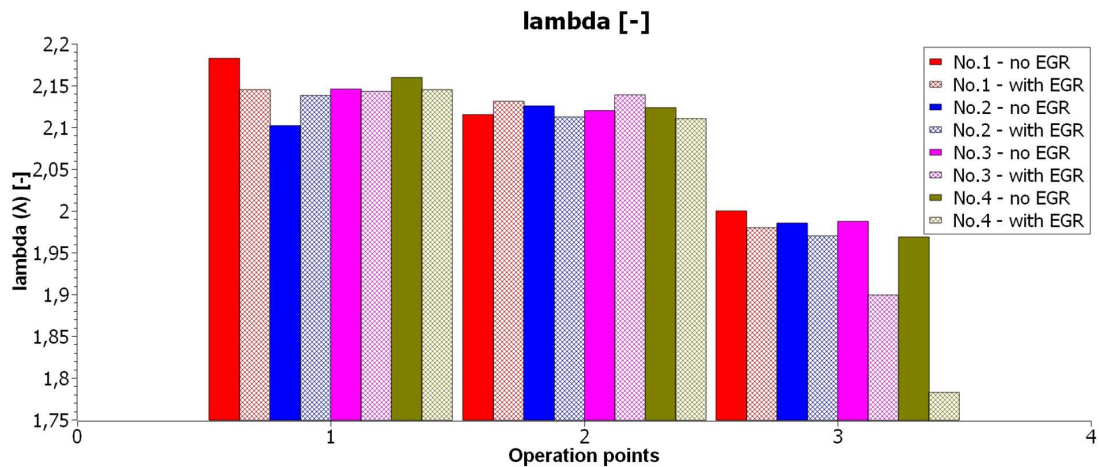

Fig. 19. The effects of using EGR and various DME premixed quantities on λ

CO emission became higher. Carbon monoxide and hydrocarbons (HC) emissions are higher in dual-fuel mode, due to the lean burn mixture under DME injection conditions in PCCI engine

operation mode which is leaner combustion than the DICI operation [11, 19].

Utilization of EGR system results in an increase in CO emissions, as depicted in Figure 16.

This can be mainly attributed to the influence of oxygen content in the air/fuel mixture. As mentioned by the authors [30], CO emissions from internal combustion engines are primarily controlled by the air/fuel ratio, they will be hard to be further oxidized, while higher EGR rate causes lower oxygen concentration in-cylinder.

Additionally, for the purpose of the present study, the air/fuel ratio (Figure 19) was maintained on the similar level for both PCCI and DICI modes, resulting in the formation of a non-optimal air/fuel mixture and incomplete combustion. Figure 17 shows the CO₂ emissions. CO₂ is a product of the combustion of coal, a component of hydrocarbon-based fuels. As it can be seen, the proportions of CO₂ in the exhaust gases are inversely proportional to the O₂ concentrations in the exhaust gases (Figure 18). For tested OP's where it was possible to maintain O₂ concentration (Figure 18) or air/fuel ratio (Figure 19) on the similar level for both PCCI and DICI modes, an increase of DME quantity demonstrates insignificant effect on CO₂ concentration in the exhaust gases. Note that due to the unstable operating conditions and jerking of the engine at OP3 with the high DME premixed quantities, it was impossible to obtain the similar level of air/fuel ratio without optimizing tested engine operation conditions.

CONCLUSIONS

In this paper, the authors investigated experimentally the effects of using exhaust gas recirculation in combination with various quantities of premixed dimethyl ether in a dual-fuel diesel engine, specifically on the combustion and exhaust performance. The main conclusions drawn from the study are as follows:

1. Utilizing DME as premixing fuel in dual-fuel diesel engine yields the divergence from the classic single stage diesel DICI combustion into relatively complex three-stage PCCI combustion. The primary factors contributing to this phenomenon are high cetane number, low boiling temperature and good auto-ignition ability exhibited by dimethyl ether. Due to a three-stage heat release process, the combustion duration is longer in PCCI mode in comparison with DICI. Under both operation modes with and without EGR, increase of DME premixed quantity had little impact on the start of the ignition in the LTR phase. It

is noteworthy that the maximum in-cylinder pressure (p_{max}) and the net heat release rate peak in the LTR and HTR phases rise when the DME concentration is higher. However, they decrease in the diffusion combustion phase due to the reduced diesel oil content. At the same time, in PCCI mode the crank angle position (ϕ_{max}) where maximum pressure (p_{max}) appeared more advanced due to three phase combustion. As mentioned above, higher DME concentration led to an increased amount of released energy in a given phase. Consequently, the ignition delay of the consecutive HTR phases and diffusion combustion is more advanced with an increase in DME premixed quantity. In the EGR operating mode, the in-cylinder pressure, temperature, and heat release traces are higher in comparison to the operation mode without EGR. This is attributed to an increasing reaction rate during the combustion process, resulting from the reintroduction of a certain part of the unburned charge retained in EGR from the previous cycles (due to the bad and/or incomplete combustion) to the cylinder.

2. With EGR, NO_x emissions maintained a low level. However, in EGR mode, NO_x emissions simultaneously increased with a rise of DME concentration. Without EGR, NO_x emission shows a descending tendency.
3. The main drawbacks concerning to a DME use as premixing fuel in dual-fuel diesel engines are associated with non-classical PCCI combustion resulting in unstable and incomplete combustion. Therefore, proper adaptation and optimization of the engine is required in order to reveal a more optimal interaction between dimethyl ether and diesel oil. Consequently, due to incomplete and unstable combustion, higher DME concentration significantly increases CO emission levels under all operation points.
4. CO₂ emissions are inversely proportional to the O₂ content in the exhaust gases.

Acknowledgements

The authors would like to thank the Nouryon Company (Christian Neefstraat 2, 1077 WW Amsterdam) for providing the DME fuel and the Ska-Tech company (street. Franciszka Okroja 22, 80-297 Miszewo) for the proper adaptation of the diesel engine to a dual-fuel operation mode.

REFERENCES

- Caban J., Vrabel J., Górnicka D., Nowak R., Jankiewicz M., Matijošius J. Overview of Energy Harvesting Technologies Used in Road Vehicles. *Energies* 2023; 16(9): 3787–3819.
- Šarkan B., Kuranc A., Sejkorova M., Caban J., Loman M. Comparison of the exhaust emissions of heavy-duty vehicle engines powered by diesel fuel (DF) and natural gas (LNG) in real operation conditions. *Przemysł Chemiczny* 2022; 101(1): 37–41.
- Ding S-L., Song E-Z., Yang L-P., Litak G., Wang Y-Y., Yao C. Analysis of chaos in the combustion process of premixed natural gas engine. *Applied Thermal Engineering* 2017; 121: 768–778.
- Jałowiec T., Wojtaszek H., Miciuła I. Analysis of the Potential Management of the Low Carbon Energy Transformation by 2050. *Energies* 2022; 15(7): 2351–2380.
- Dudley B. BP Energy Outlook 2019 edition: The Energy Outlook explores the forces shaping the global energy transition out to 2040 and the key uncertainties surrounding that. BP Energy Outlook, 2019.
- Stepanenko D., Kneba Z. DME as alternative fuel for compression ignition engines – a review. *Combustion Engines* 2019; 177(2): 172–179.
- Malek A., Taccani R., Kasperek D., Hunicz J. Optimization of energy management in a city bus powered by the hydrogen fuel cells. *Communications - Scientific Letters of the University of Žilina* 2021; 23(4): 56–67.
- Gardyński L., Kałdonek J., Caban J. Testing of Lubricating Properties of Mixtures of Diesel and Rme Biofuels With the Addition of Linoleic Acid. *Archives of Automotive Engineering* 2020; 87(1): 57–66.
- Monieta J., Szmukała M., Adamczyk F. The effect of natural deterioration on selected properties of rapeseed oil methyl esters. *Fuel* 2022; 330.
- Han S., Sik C. Applicability of dimethyl ether (DME) in a compression ignition engine as an alternative fuel. *Energy Conversion and Management* 2014; 86: 848–863.
- Theinnoi K., Suksompong P., Temwutthikun W. Engine Performance of Dual Fuel Operation with In-cylinder Injected Diesel Fuels and In-Port Injected DME. *Energy Procedia* 2017; 142: 461–467.
- Anubhav D., Kumar N., Saluja R-K. Optimization of Fuel Injection Strategies for Sustainability of DME in Combustion Engine. Springer Singapore 2022: 293–314.
- Mehra S., Agarwal A-K. Prospects and Challenges of DME Fueled Low-Temperature Combustion Engine Technology. Springer Singapore 2022: 261–291.
- Pham V-C., Rho B-S., Kim J-S., Lee W-J., Choi J-H. Effects of Various Fuels on Combustion and Emission Characteristics of a Four-Stroke Dual-Fuel Marine Engine. *Journal of Marine Science and Engineering* 2021; 9(10):1072–1104.
- Mittal G. Influence of fuel injection timing in a DME based CI engine at low load. *Materials Today: Proceedings* 2021; 46: 10987–10990.
- Ga B Van., Thai PQ. Soot emission reduction in a biogas-dme hybrid dual-fuel engine. *Applied Sciences* 2020; 10(10): 3416–3435.
- Park J., Choi I., Oh J., Lee C. Preliminary numerical study on exhaust emission characteristics of particulate matters and nitrogen oxide in a marine engine for marine diesel oil and dimethyl ether fuel. *Journal of Marine Science and Engineering* 2020; 8(5): 316–331.
- Shere A., Subramanian KA. Performance Enhancement and Emissions Reduction in a DME Fueled Compression Ignition Engine Using Hydrogen Under Dual-Fuel. Springer Nature Singapore 2023: 505–523.
- Sittichompoo S., Pridoung P., Sriphumma P., Songklod R., Theinnoi K. Effects of DME port-injection on performances of a single cylinder diesel engine in dual-fuel mode. The 2nd International Conference on Engineering Science and Innovative Technology (ESIT), Phuket, Thailand 2016.
- Wang Y., Zhao Y., Xiao F., Li D. Combustion and emission characteristics of a diesel engine with DME as port premixing fuel under different injection timing. *Energy Conversion and Management* 2014; 77: 52–60.
- Ying W., Li H., Longbao Z., Wei L. Effects of DME pilot quantity on the performance of a DME PCCI-DI engine. *Energy Conversion and Management* 2010; 51(4): 648–654.
- Stepanenko D., Kneba Z. ECU calibration for gaseous dual fuel supply system in compression ignition engines. *Combustion Engines* 2020; 182(3): 33–37.
- Siadkowska K., Barański G., Sochaczewski R., Wendeker M. Experimental Investigation on Indicated Pressure and Heat Release for Direct Hydrogen Injection in a Dual Fuel Diesel Engine. *Advances in Science and Technology Research Journal* 2022; 16(3): 54–66.
- Stepanenko D., Kneba Z., Rudnicki J. Numerical methodology for evaluation the combustion and emissions characteristics on WLTP in the light duty dual-fuel diesel vehicle. *Combustion Engines* 2022; 189(2): 94–102.
- Kimo. Kigaz 310. Combustion Gas Analyzer. User Manual. Retrieved from: https://sauer-manngroup.com/sites/default/files/2017-09/NTang_Kigaz310_12-07-17.pdf.
- Krieger R-B., Borman G-L. Engineers AS of M. The computation of apparent heat release for internal combustion engines. ASME, 1966.

27. McBride B-J., Zehe M-J., Gordon S. NASA Glenn coefficients for calculating thermodynamic properties of individual species. National Aeronautics and Space Administration. John H. Glenn Research Center at Lewis Field, 2002.
28. Hu S., Wang H., Yang C., Wang Y. Burnt fraction sensitivity analysis and 0-D modelling of common rail diesel engine using Wiebe function. *Applied Thermal Engineering* 2017; 115: 170–177.
29. Ying W., Li H., Longbao Z., Wei L. Effects of DME pilot quantity on the performance of a DME PCCI-DI engine. *Energy Conversion and Management* 2010; 51(4): 648–654.
30. Chen Z., Liu J., Wu Z., Lee C. Effects of port fuel injection (PFI) of n-butanol and EGR on combustion and emissions of a direct injection diesel engine. *Energy Conversion and Management* 2013; 76(10): 725–731.