



The author of the doctoral dissertation: Hanan Tariq
Scientific discipline: Automation, Electronics, Electrical Engineering
And Space Technologies

DOCTORAL DISSERTATION

Title of doctoral dissertation: **Residual current protective device for circuits of distorted earth fault currents – concept, construction and testing**

Title of doctoral dissertation (in Polish): **Zabezpieczenie różnicowoprądowe do obwodów o odkształconych prądach ziemnozwarciowych – koncepcja, wykonanie i badanie**

Supervisor
<i>signature</i>
Prof. dr hab. inż. Stanisław Czapp

Gdańsk, year 2024



Imię i nazwisko autora rozprawy: Hanan Tariq
Dyscyplina naukowa: Automatyka, Elektronika, Elektrotechnika i
Technologie Kosmiczne

ROZPRAWA DOKTORSKA

Tytuł rozprawy doktorskiej w języku polskim: **Zabezpieczenie różnicowoprądowe do obwodów o odkształconych prądach ziemnozwarciowych – koncepcja, wykonanie i badanie**

Tytuł rozprawy doktorskiej w języku angielskim: **Residual current protective device for circuits of distorted earth fault currents – concept, construction and testing**

Promotor
<i>podpis</i>
Prof. dr hab. inż. Stanisław Czapp

Gdańsk, rok 2024





STATEMENT

The author of the doctoral dissertation: Hanan Tariq

I, the undersigned, declare that I am aware that in accordance with the provisions of Art. 27 (1) and (2) of the Act of 4th February 1994 on Copyright and Related Rights (Journal of Laws of 2021, item 1062), the university may use my doctoral dissertation entitled:

Residual current protective device for circuits of distorted earth fault currents – concept, construction and testing.

for scientific or didactic purposes.¹

Gdańsk, 10.06.2024

signature of the PhD student

Aware of criminal liability for violations of the Act of 4th February 1994 on Copyright and Related Rights and disciplinary actions set out in the Law on Higher Education and Science (Journal of Laws 2021, item 478), as well as civil liability, I declare, that the submitted doctoral dissertation is my own work.

I declare, that the submitted doctoral dissertation is my own work performed under and in cooperation with the supervision of Prof. dr hab. inż. Stanisław Czapp.

This submitted doctoral dissertation has never before been the basis of an official procedure associated with the awarding of a PhD degree.

All the information contained in the above dissertation which is derived from written and electronic sources is documented in a list of relevant literature in accordance with Art. 34 of the Copyright and Related Rights Act.

I confirm that this doctoral dissertation is identical to the attached electronic version.

Gdańsk, 10.06.2024

signature of the PhD student

I, the undersigned, agree to include an electronic version of the above doctoral dissertation in the open, institutional, digital repository of Gdańsk University of Technology.

Gdańsk, 10.06.2024

signature of the PhD student

¹ Art 27. 1. Educational institutions and entities referred to in art. 7 sec. 1 points 1, 2 and 4–8 of the Act of 20 July 2018 – Law on Higher Education and Science, may use the disseminated works in the original and in translation for the purposes of illustrating the content provided for didactic purposes or in order to conduct research activities, and to reproduce for this purpose disseminated minor works or fragments of larger works.

2. If the works are made available to the public in such a way that everyone can have access to them at the place and time selected by them, as referred to in para. 1, is allowed only for a limited group of people learning, teaching or conducting research, identified by the entities listed in paragraph 1.





OŚWIADCZENIE

Autor rozprawy doktorskiej: Hanan Tariq

Ja, niżej podpisany(a), oświadczam, iż jestem świadomy(a), że zgodnie z przepisem art. 27 ust. 1 i 2 ustawy z dnia 4 lutego 1994 r. o prawie autorskim i prawach pokrewnych (t.j. Dz.U. z 2021 poz. 1062), uczelnia może korzystać z mojej rozprawy doktorskiej zatytułowanej:

Zabezpieczenie różnicowoprądowe do obwodów o odkształconych prądach ziemnozwarciowych – koncepcja, wykonanie i badanie.

do prowadzenia badań naukowych lub w celach dydaktycznych.¹

Świadomy(a) odpowiedzialności karnej z tytułu naruszenia przepisów ustawy z dnia 4 lutego 1994 r. o prawie autorskim i prawach pokrewnych i konsekwencji dyscyplinarnych określonych w ustawie Prawo o szkolnictwie wyższym i nauce (Dz.U.2021.478 t.j.), a także odpowiedzialności cywilno- prawnej oświadczam, że przedkładana rozprawa doktorska została napisana przeze mnie samodzielnie.

Oświadczam, że treść rozprawy opracowana została na podstawie wyników badań prowadzonych pod kierunkiem i w ścisłej współpracy z promotorem Prof. dr hab. inż. Stanisław Czapp.

Niniejsza rozprawa doktorska nie była wcześniej podstawą żadnej innej urzędowej procedury związanej z nadaniem stopnia doktora.

Wszystkie informacje umieszczone w ww. rozprawie uzyskane ze źródeł pisanych i elektronicznych, zostały udokumentowane w wykazie literatury odpowiednimi odnośnikami, zgodnie z przepisem art. 34 ustawy o prawie autorskim i prawach pokrewnych.

Potwierdzam zgodność niniejszej wersji pracy doktorskiej z załączoną wersją elektroniczną.

Gdańsk, dnia 10.06.2024

.....
podpis doktoranta

Ja, niżej podpisany(a), wyrażam zgodę na umieszczenie ww. Rozprawy doktorskiej w wersji elektronicznej w otwartym, cyfrowym repozytorium instytucjonalnym Politechniki Gdańskiej.

Gdańsk, dnia 10.06.2024

.....
podpis doktoranta

¹ Art. 27. 1. Instytucje oświatowe oraz podmioty, o których mowa w art. 7 ust. 1 pkt 1, 2 i 4–8 ustawy z dnia 20 lipca 2018 r. – Prawo o szkolnictwie wyższym i nauce, mogą na potrzeby zilustrowania treści przekazywanych w celach dydaktycznych lub w celu prowadzenia działalności naukowej korzystać z rozpowszechnionych utworów w oryginale i w tłumaczeniu oraz zwielokrotnić w tym celu rozpowszechnione drobne utwory lub fragmenty większych utworów.

2. W przypadku publicznego udostępniania utworów w taki sposób, aby każdy mógł mieć do nich dostęp w miejscu i czasie przez siebie wybranym korzystanie, o którym mowa w ust. 1, jest dozwolone wyłącznie dla ograniczonego kręgu osób uczących się, nauczających lub prowadzących badania naukowe, zidentyfikowanych przez podmioty wymienione w ust. 1





DESCRIPTION OF DOCTORAL DISSERTATION

Author of the doctoral dissertation: Hanan Tariq

Title of doctoral dissertation: Residual current protective device for circuits of distorted earth fault currents – concept, construction and testing

Title of doctoral dissertation in Polish: Zabezpieczenie różnicowoprądowe do obwodów o odkształconych prądach ziemnozwarciowych – koncepcja, wykonanie i badanie

Language of doctoral dissertation: English

Supervisor: Prof. dr hab. inż. Stanisław Czapp

Date of doctoral defense:

Keywords of doctoral dissertation in English: protection against electric shock, residual current devices, earth fault current, harmonics, testing, direct current, high-frequency.

Keywords of doctoral dissertation in Polish: ochrona przed porażeniem elektrycznym, urządzenia różnicowoprądowe, prąd ziemnozwarciowy, harmoniczne, testowanie, prąd stały, wysoka częstotliwość



Summary of doctoral dissertation in English:

This dissertation presents behavioral and performance verification and analysis of residual current devices (RCDs), as well as a proposal for the construction of a new RCD protection.

The state of the art focuses over pre-existing design of the RCD and its behavior and response to the circuits with distorted (non-sinusoidal) earth fault currents. The study highlights the loopholes of the existing design and depicts the problem of unresponsiveness of the RCD against smooth DC, very low-frequency and very high-frequency earth fault currents. For this, most commonly used types (AC, A, B and F) of RCDs were exposed to a series of testing mechanism more extensive than required by standards. Considering the type of problem a new design has been proposed in this dissertation that can outperform the existing design and can trip at even DC and at high-frequency level (40 kHz). Again, comprehensive testing was conducted to assess the newly designed RCD's response to such abnormal earth fault current. The test results confirms its efficiency and practicality for real world applications.

Hence, the conclusion is provided that this new design is capable of performing its designated function to ensure electrical safety. This new design contributes towards an advancement in the field of low-voltage electrical safety and paves a way for more sensitive RCDs. Moreover, a patent application for this new solution has been submitted to the Polish patent office.

Summary of doctoral dissertation in Polish:

W rozprawie przedstawiono właściwości obecnie dostępnych zabezpieczeń różnicowoprądowych (RCDs) oraz propozycję nowej konstrukcji zabezpieczenia różnicowoprądowego (RCD).

Dokonano przeglądu aktualnego stanu wiedzy dotyczącego konstrukcji obecnie dostępnych zabezpieczeń różnicowoprądowych oraz wykonano szerokie badania laboratoryjne reakcji tych zabezpieczeń na prądy różnicowe o wybranych przebiegach. Badania wykazały, że istniejące zabezpieczenia (typu AC, A, B oraz F) mogą mieć pogorszoną czułość lub w ogóle nie reagować na prądy o bardzo niskiej częstotliwości, bardzo wysokiej częstotliwości oraz prądy jednokierunkowe o niewielkim tętnieniu. Mając na uwadze wady tych zabezpieczeń, zaproponowano nową konstrukcję zabezpieczenia różnicowoprądowego, które ma bardzo dobrą charakterystyką działania przy prądach stałych nawet całkowicie wygładzonych oraz prądach o częstotliwości do 40 kHz. Wyniki badań wykazały, że możliwości tego nowego zabezpieczenia różnicowoprądowego przewyższają możliwości powszechnie dostępnych zabezpieczeń.

Zabezpieczenie o zaproponowanej konstrukcji, przebadanej w warunkach laboratoryjnych, może przyczynić się do zwiększenia bezpieczeństwa użytkowania urządzeń elektrycznych w nowoczesnych systemach niskiego napięcia. Zaproponowana konstrukcja została zgłoszona do opatentowania.



OPIS ROZPRAWY DOKTORSKIEJ

Autor rozprawy doktorskiej: Hanan Tariq

Tytuł rozprawy w języku angielskim: Residual current protective device for circuits of distorted earth fault currents – concept, construction and testing

Tytuł rozprawy doktorskiej w języku polskim: Zabezpieczenie różnicowoprądowe do obwodów o odkształconych prądach ziemnozwarciowych – koncepcja, wykonanie i badanie

Język rozprawy doktorskiej: Angielski

Promotor rozprawy doktorskiej: Prof. dr hab. inż. Stanisław Czapp

Data obrony:

Słowa kluczowe rozprawy doktorskiej w języku polskim: ochrona przed porażeniem elektrycznym, urządzenia różnicowoprądowe, prąd ziemnozwarciowy, harmoniczne, testowanie, prąd stały, wysoka częstotliwość

Słowa kluczowe rozprawy doktorskiej w języku angielskim: protection against electric shock, residual current devices, earth fault current, harmonics, testing, direct current, high-frequency



**Streszczenie rozprawy w języku polskim:**

W rozprawie przedstawiono właściwości obecnie dostępnych zabezpieczeń różnicowoprądowych (RCDs) oraz propozycję nowej konstrukcji zabezpieczenia różnicowoprądowego (RCD).

Dokonano przeglądu aktualnego stanu wiedzy dotyczącego konstrukcji obecnie dostępnych zabezpieczeń różnicowoprądowych oraz wykonano szerokie badania laboratoryjne reakcji tych zabezpieczeń na prądy różnicowe o wybranych przebiegach. Badania wykazały, że istniejące zabezpieczenia (typu AC, A, B oraz F) mogą mieć pogorszoną czułość lub w ogóle nie reagować na prądy o bardzo niskiej częstotliwości, bardzo wysokiej częstotliwości oraz prądy jednokierunkowe o niewielkim tętnieniu. Mając na uwadze wady tych zabezpieczeń, zaproponowano nową konstrukcję zabezpieczenia różnicowoprądowego, które ma bardzo dobrą charakterystyką działania przy prądach stałych nawet całkowicie wygładzonych oraz prądach o częstotliwości do 40 kHz. Wyniki badań wykazały, że możliwości tego nowego zabezpieczenia różnicowoprądowego przewyższają możliwości powszechnie dostępnych zabezpieczeń.

Zabezpieczenie o zaproponowanej konstrukcji, przebadanej w warunkach laboratoryjnych, może przyczynić się do zwiększenia bezpieczeństwa użytkowania urządzeń elektrycznych w nowoczesnych systemach niskiego napięcia. Zaproponowana konstrukcja została zgłoszona do opatentowania.

Streszczenie rozprawy w języku angielskim:

This dissertation presents behavioral and performance verification and analysis of residual current devices (RCDs), as well as a proposal for the construction of a new RCD protection.

The state of the art focuses over pre-existing design of the RCD and its behavior and response to the circuits with distorted (non-sinusoidal) earth fault currents. The study highlights the loopholes of the existing design and depicts the problem of unresponsiveness of the RCD against smooth DC, very low-frequency and very high-frequency earth fault currents. For this, most commonly used types (AC, A, B and F) of RCDs were exposed to a series of testing mechanism more extensive than required by standards. Considering the type of problem a new design has been proposed in this dissertation that can outperform the existing design and can trip at even DC and at high-frequency level (40 kHz). Again, comprehensive testing was conducted to assess the newly designed RCD's response to such abnormal earth fault current. The test results confirms its efficiency and practicality for real world applications.

Hence, the conclusion is provided that this new design is capable of performing its designated function to ensure electrical safety. This new design contributes towards an advancement in the field of low-voltage electrical safety and paves a way for more sensitive RCDs. Moreover, a patent application for this new solution has been submitted to the Polish patent office.

ACKNOWLEDGMENT

I am grateful to Allah, who gave me the opportunity and strength to execute this work.

First of all, I would like to express my gratitude and appreciation to my supervisor and mentor, Professor Stanisław Czapp, for all of his guidance, help and training throughout my PhD journey. He didn't just guide me in my professional proceedings; but also helped me adjust to a new culture and environment during my long stay in this beautiful country, Poland.

I would also like to thank the faculty members and staff of the Electrical Power Engineering department at Gdańsk University of Technology, with whom I had interactions, for all the kindness and help during my studies.

I would like to thank all of my family members, especially my parents, for their prayers, moral support and long telephonic conversations. I would also like to thank my brother, Sarmad, for his technical guidance and vast discussions on the behavior of electrical networks.

Last but not least, I would like to thank my wife, Hareem, and my son, Aafeen, for their encouragement and presence during my worst days. The whole PhD journey would be tougher without their support. I dedicate this dissertation to both of them.

CONTENTS

CONTENTS	1
LIST OF IMPORTANT ABBREVIATIONS AND SYMBOLS	3
1 INTRODUCTION AND OBJECTIVES OF DISSERTATION	5
1.1 Motivation/Research Problem	5
1.2 Purpose of research.....	5
1.3 Thesis.....	6
1.4 Structure of dissertation.....	6
2 REVIEW OF EXISTING LITERATURE	8
2.1 Generations / history of residual current devices	8
2.2 Construction of modern day residual current devices	12
2.2.1 Electromechanical relay	12
2.2.2 Current transformer.....	15
2.2.3 Built-in testing circuit	18
2.3 Types and characteristics of residual current device	19
2.3.1 Types with respect to operational characteristics	19
2.3.2 Rated residual operating current	21
2.3.3 Rated frequency	21
2.3.4 Rated voltage and its connection with number of poles	21
2.3.5 RCDs with delayed tripping.....	22
2.4 Permissible limits defined in standards	23
2.5 Electric shock protection	25
2.5.1 Time constraint	25
2.5.2 Electric shock protection in TN system	26
2.5.3 Electric shock protection in TT system	27
2.5.4 Electric shock protection in IT system.....	27
2.5.5 Effects of electric shock on human body	28
2.6 Fire protection.....	29
2.6.1 Fire protection from leakage current.....	30
2.6.2 Fire protection from arcing	31
2.7 Sinusoidal and non-sinusoidal residual currents	32
2.7.1 Rectified residual current waveform.....	33
2.7.2 Distorted residual current waveform (harmonics)	33
3 TESTING OF PRE-EXISTING RESIDUAL CURRENT DEVICES.....	35
3.1 Normative and broader scope testing	35
3.2 Response to pure sinusoidal high-frequency sudden applied residual current	36



3.2.1	Laboratory test bench.....	36
3.2.2	List of tested RCDs for suddenly applied high-frequency test	37
3.2.3	Test results	38
3.3	Response to suddenly applied mixed-frequency components	43
3.3.1	Sample waveforms.....	44
3.3.2	List of tested RCDs	49
3.3.3	Laboratory test bench.....	49
3.3.4	Test results	50
3.4	Response to suddenly applied DC residual current	65
3.4.1	List of tested RCDs.....	66
3.4.2	Laboratory test bench.....	66
3.4.3	Test results	67
3.5	Response to slowly rising residual current– from DC (0 Hz) to 50 kHz	71
3.5.1	List of tested RCDs	72
3.5.2	Test bench	73
3.5.3	Test results	73
4	NEWLY DESIGNED RCD	86
4.1	Concept and design.....	86
4.2	Equipment description	86
4.3	Working	88
4.4	Test results.....	90
4.4.1	Response to suddenly applied pure DC and very high-frequency	90
4.4.2	Response to mixed-frequency residual currents	91
4.4.3	Response to slowly rising residual current	93
5	SUMMARY AND CONCLUSION	96
6	FUTURE WORK	98
	LIST OF TABLES	99
	LIST OF FIGURES.....	100
	REFERENCES.....	105



LIST OF IMPORTANT ABBREVIATIONS AND SYMBOLS

RCD – residual current device
IEC – International Electrotechnical Commission
HD – Harmonization Document
EN – European Norm
IMD – insulation monitoring devices
RCM – residual current monitor
MCB – miniature circuit-breaker
AFDD – arc fault detection device
VSD – variable speed drive
PWM – pulse width modulation
LED – light emitting diode
RCCB – residual current circuit breaker
RCBO – residual current circuit breaker with overcurrent protection
 F_{armature} – magnetic force
 B_{flux} – magnetic flux density
 A_{cross} – cross-sectional area of core
 μ_0 – vacuum permeability
 k – spring constant
 X_{spring} – displacement of the spring
 Q – charge of the capacitor
 C – capacitance
 I_{T} – sinusoidal residual current
 I_{p} – value of peak current
 f – frequency
 t – time
 I_{res} – residual current
 I_{L} – current in line or phase conductor
 I_{N} – current in neutral conductor
kA – kiloampere
A – ampere
mA – milliampere
DC – direct current
AC – alternating current
s – second
ms – millisecond
C.T – current transformer
mW – milliwatt
W – watt
cm – centimeter
 $I_{\Delta n}$ – rated residual operating current
kHz – kilohertz
Hz – hertz



V – voltage
I – current
Z – impedance
PE – protective earthing
N – neutral
L – line
R – resistance
TS – technical specification
P – power
T – tripping
N.T – no tripping
MF – mixed-frequency
RMS – root mean square
Mr – manufacturer
C.B – circuit-breaker
RL – relay
BR – bridge rectifier
VRS – variable resistance
CR – adapter
BY – cell battery for backup
SS – battery charging surveillance circuit
BB – boost converter

1 INTRODUCTION AND OBJECTIVES OF DISSERTATION

1.1 Motivation/Research Problem

For years, humans have been injured by electrical shocks while handling domestic as well as industrial electronic appliances. European countries and almost all major global markets advocate the use of a residual current device (RCD) in electrical circuits for the purpose of low-voltage electrical safety. However, an effective protection scheme against electric shock hazard is dependent on multiple factors such as proper selection of the RCD for required application and also on the surety of RCD's operation. Provisions of the standard HD 60364-4-41 [1] states the obligation of highly sensitive RCDs in the circuits up to 32 A. These circuits include lightning equipment and outdoor equipment for single household usage. Some other standards also advocate the usage of RCDs such as in standard HD (IEC) 60364 'Low-voltage electrical installations'. All the obligations for human life protection and safety can be fulfilled, still one will remain doubtful which is 'surety of RCD's operation'. RCD, also known as earth leakage current detector, provides an efficient protection against electrocution for both indirect and direct contact with exposed parts of electric equipment [2]. Also, it can provide safety against fire (due to short circuit) to some extent [3]. However, constantly rising induction of power electronic circuits in the power system has resulted in major expansion of non-sinusoidal currents or harmonics. The equipment responsible for the generation of aforementioned currents is mostly laptops/computers, inverters, battery charging stations, frequency converters, renewables etc. The aforesaid are the few examples of problematic things for power system efficiency. Overall, the current and voltage sine waveforms get distorted due to harmonic influx [4]. Another concerning problem raised due to harmonics is stray/leakage current – main reason of this type of current is the application of anti-interference filters. The stray/leakage current can make a path towards structure of the building and other constructive parts such as water and heating pipes. In nominal conditions, RCD should detect residual currents but in the presence of harmonics (distorted waveform), the operation of RCD gets doubtful [5].

1.2 Purpose of research

Effective protection against electric shock must be ensured due to the inertial nature of electrical network. The surety of effective protection is endorsed by a standard EN 61140 [6], which states that "Hazardous-live-parts are not allowed to be accessible, and accessible conductive parts are not allowed to be hazardous-live". For safety from electrocution, both direct and indirect contact protection has to be avoided and the best and most reliable method



is the disconnection of supply/source. In such cases, RCD can act as one of the best available options for safety from electric shock [7], [8], [9]. Direct contact means all current flows directly towards ground via human body. In the case of electric shock, where a person is creating an electric path towards the ground, the normative equipment such as electric fuses and circuit-breakers will not be able to perform the disconnection phenomenon. This is because in the case of such contact, the amount of current passing through human body could be about 30 mA, which is not enough for such equipment to respond. The indirect contact can be referred to as an insulation damage/failure fault. In both cases, only a reliable type of RCD can avoid the risk of fatal injuries because of electric shock. In order to detect the insulation failure which is further a big risk initiating a fire or electric shock, the proper type of RCD should be selected according to the properties and requirements of the power system. The main aim and motivation for this investigation is to reconsider the existing design of RCDs and involve them in a series of testing phenomena in a broader range than indicated by universal standards, point out the gaps in the design and its ensured operation and verify the tripping behavior. Likewise, there is a need to address RCD's tripping/detection problems with the earth fault current and present a feasible solution with an improved novel design composed of cutting-edge approaches, so that it could perform its specified operations in the presence of high-frequency earth fault currents, harmonics/supraharmonics or even in the presence of low/zero frequency (DC) residual currents and ensure electric shock protection in abnormal situations as well.

1.3 Thesis

Residual current devices currently used in low-voltage systems to detect earth fault currents with frequencies below 50 Hz, significantly higher than 50 Hz and direct currents with negligible pulsation, require the presence of an auxiliary voltage in the supply network for proper operation. It is possible to design a residual current device that detects such currents correctly even in the absence of auxiliary supply in this network for a relatively long time.

1.4 Structure of dissertation

This work has been structured as follows:

- First chapter is based on a brief introduction of research problem and a slight overview of the standards that aren't matched up to the mark which is the mal-tripping of the RCD under certain conditions within permissible limits defined by standards. Moreover, it highlights the need or purpose of this work, as well as the aim and advantages that will be achieved by the end of this work.

INTRODUCTION AND OBJECTIVES OF DISSERTATION

- Second chapter totally focuses over the available literature of the RCD that includes history and generation of RCD. It also discusses latest design, construction and the working principle of the latest available RCDs. Chapter 2 also emphasizes on the types of the RCD and furthermore there is going to be discussion about its intended role during electric shock and its intended behavior during fire emergency.
- Third chapter is totally about the verification of the RCD's behavior during faulty conditions. A series of test is performed in the lab of Gdansk University of Technology that includes high-frequency, low-frequency and tests based on DC fault currents.
- Fourth chapter is about presenting a new design and an idea for the RCD. Then the verification of its behavior was done and supremacy of the new design was proved during the lab tests and with a comparison to available standards.
- At the end of this writing (fifth chapter), a brief summary and conclusion was written to sum up the whole work briefly for the ease of readers.
- Future work has been proposed in chapter 6 of this dissertation.

2 REVIEW OF EXISTING LITERATURE

2.1 Generations / history of residual current devices

The earliest design of today's RCD dates back to the beginning of the 20th century, the period when the very first patent was issued in 1928 that refers to the detection of residual earth fault currents [10]. This invention was patented in Germany concerning the low-voltage electric power network and focuses on the protection of humans and livestock when they happen to be in contact with the live part of the conductor. The patent application emphasized that the tripping phenomenon of the protection device should only be initiated in case of presence of residual current in the circuit (after the sum of all the phase currents) [11], [12]. Nevertheless, the explanation lacked precision regarding the particular process that triggers the protection device. The instructions just exhibited quick operation (within 0.1 s) with quite high sensitivity, guaranteeing the safety/protection of humans and livestock in proximity to live conductors. However, this whole mechanism was focused on the direct contact with the live conductor and ignored the indirect contact in that era. Considering the aforementioned idea of the patent, this device was supposed to disconnect when it detected a residual current ranging from 10-50 mA. During that period, it was difficult to create a protection device that met specific modern day requirements (30 mA current and 0.1 s of tripping time), due to the presence of leakage current in old electrical installations and the unavailability of the equipment for manufacturing such devices [13].

However, the more realistic approach to the present-day design of RCD can be traced back to the 1930s and 1940s. In his 1943's book, Paul Schnell described a protective device that had similarities to modern Residual Current Devices (RCDs). The early version consisted of fundamental elements including a current transformer, an electromechanical relay, a permanent magnet, and a spring. The device operates by generating a secondary current when an earth fault is present. The secondary current had an impact on the electromechanical relay, influencing the secondary circuit that contained a spring and a permanent magnet. The resultant decrease in the magnetic field eventually resulted in the disconnection of the circuit. The initial residual current device (RCD) possessed a rated residual operating current of 10 mA and a rapid tripping time that did not surpass 0.1 s. Figure 1 explain the design presented in the aforementioned book.

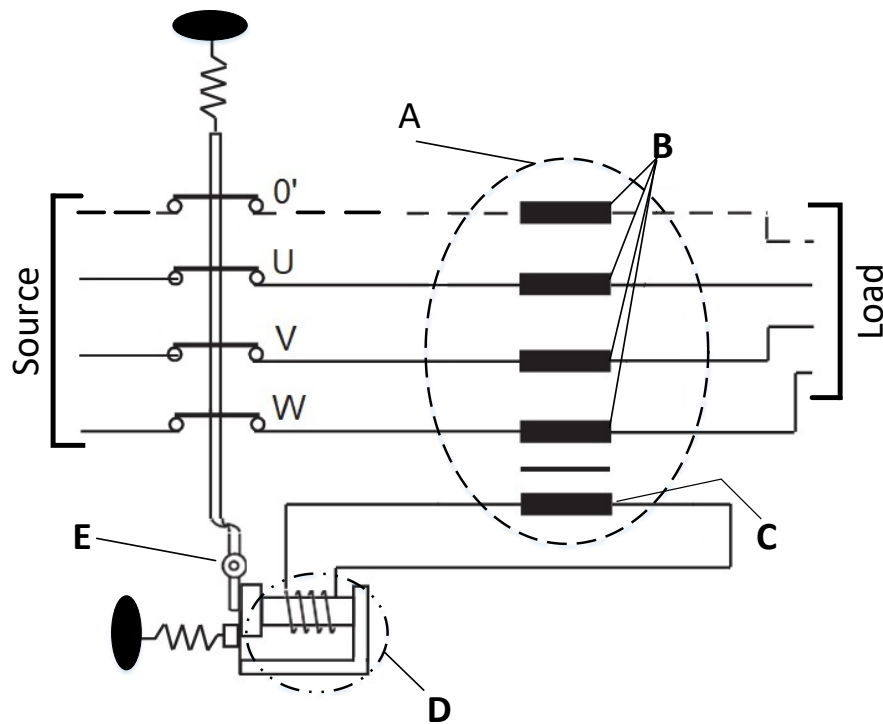

Figure 1: P. Schnell's design of residual current device; A – current transformer (C.T), B – primary side of C.T, C – secondary side of C.T, D – relay, and E – switching tool. [14]

The first ever residual current device that was commercially available and produced in 1949, the credit goes to the company, known as Schrack and was followed by Felter & Guillaume in 1951. Those early devices were characterized by their substantial size, quite limited sensitivity, a higher rated residual current of 1 A or 3 A. Such devices have doubtful reliability because of their vulnerability to disturbances. Moreover, such devices had a higher cost and they usually require an auxiliary supply to be fed to the secondary part of the transformer in order to ensure the reliable operation of such devices. Figure 2 explains the design of this type of residual current device that was being introduced in early days. In this design, in order to increase the operational reliability of the device, a diode bridge was introduced, connecting all phases to initiate tripping mechanism. It is to counter a problem raised due to residual current (after being detected) was transmuted towards the transformer's secondary side, influencing the detection relay in the circuit and eventually affecting the tripping phenomenon.

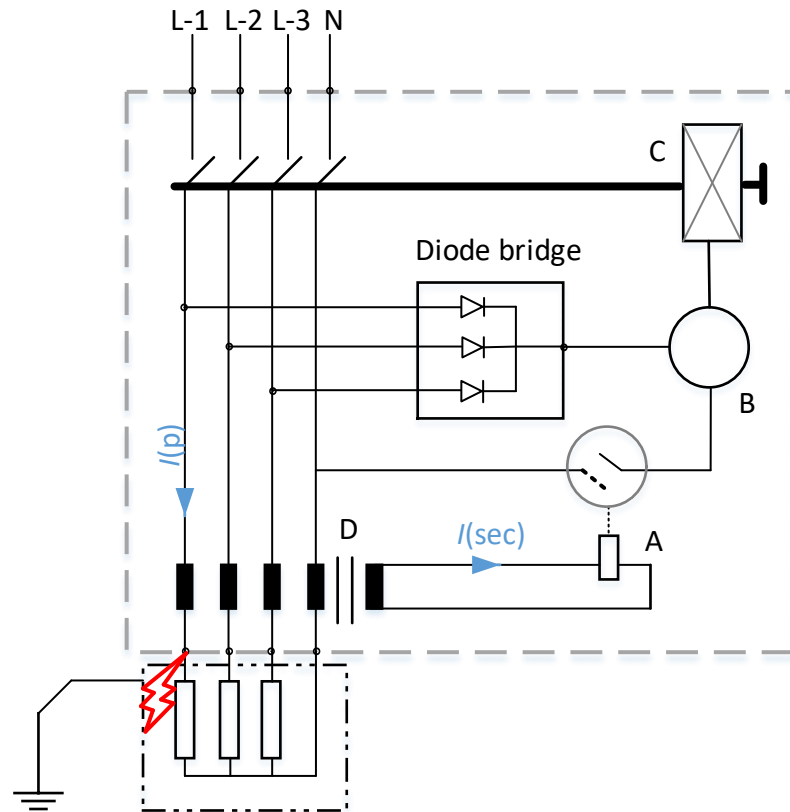

Figure 2: Early model of residual current device; voltage-dependent RCD with a diode bridge and overcurrent release mechanism on secondary circuit of current transformer; $I(p)$ – transformer’s primary current, $I(sec)$ – transformer’s secondary current, A – relay, B – overcurrent release device, C – switching equipment, D – current transformer.

An effective solution was recommended by Prof. Biegelmeier in 1957. In the proposition, it was recommended to equip the residual current device with a switching mechanism and transformer’s secondary was connected to some energy storage system. In the case where residual current is present in the circuit, the energy storage device will first charge itself and then send a surge to some electronic circuit signaling it to turn-on the forward biasing of the new electronic element. In such a way, relay is supplied with sufficient voltage to initiate the tripping mechanism of the device. It was the first ever design that led to the construction of modern day devices to detect residual current that are mostly voltage-independent. The first ever commercially constructed device of this kind was initiated in 1958 by Felten & Guillaume. Figure 3 exhibits the internal circuit of this idea. The basics of construction for modern day residual current devices are quite similar to those explained in Figure 3.

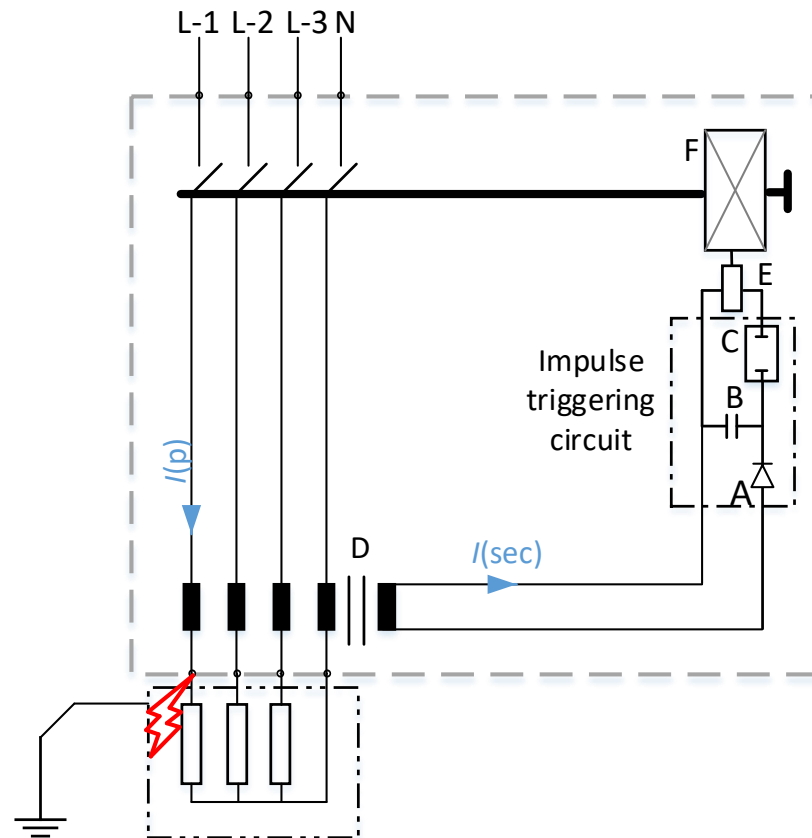

Figure 3: RCD model with impulse triggering circuit; $I(p)$ – primary current of transformer, $I(p)$ – transformer's primary current, $I(sec)$ – transformer's secondary current, A – diode, B – charge storage equipment, C – electronic switching equipment, D – current transformer, E – relay, F – switching equipment.

Nowadays, most RCDs are voltage independent [15], [16] and constructively comprised of an electromechanical relay, iron core current transformer, electronic module for imposing a delay or sensitivity in the circuit of the device [17]. More electronic circuits can be included in the design of RCD in order to maximize the sensitivity or add delay to the tripping incident. The magnetic flux responsible for initiating tripping is produced only if there is a residual current inside the summation current transformer. It is obliged to connect the equipment to all three live lines (conductors) and neutral of the network. Secondary current will be produced because of the magnetic flux inside the current transformer. As soon as the secondary current crosses the predefined threshold value, it will enforce the tripping of the device. Figure 4 presents the internal circuit of the aforementioned modern RCD [18].

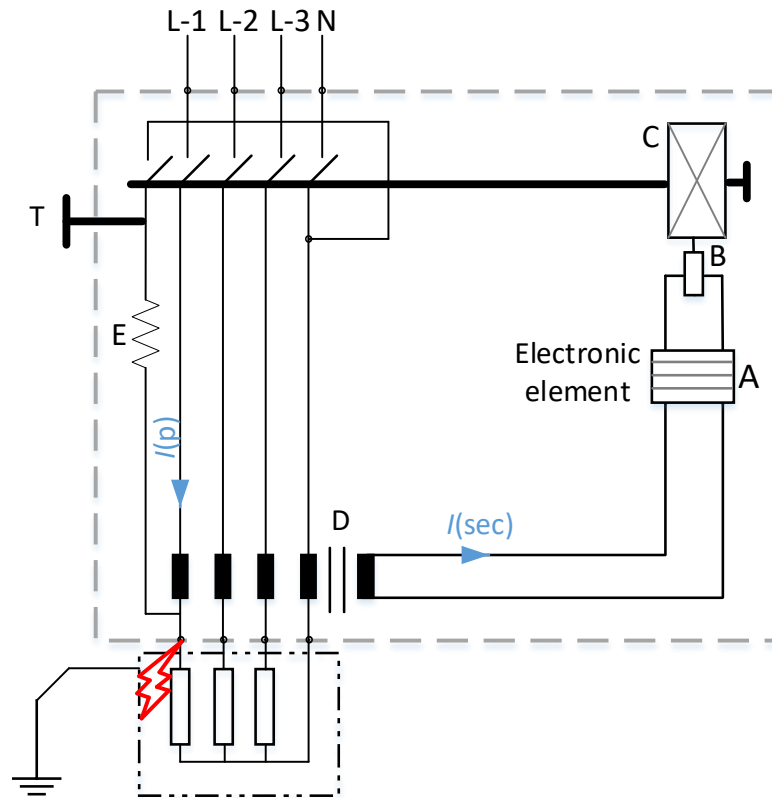

Figure 4: Modern day design of residual current device; $I(p)$ – transformer’s primary current, $I(sec)$ – transformer’s secondary current, T – test button, A – matching electronic circuit, B – relay, C – switching equipment, D – current transformer, E – current limiting resistor for testing circuit.

2.2 Construction of modern day residual current devices

The modern residual current devices are comprised of many components as mentioned in 2.1. However, the most important ones are relay (electromechanical), summation current transformer, and test circuit (internal) [19], [20]. The topic will explain the working and construction of these components specifically.

2.2.1 Electromechanical relay

There are different methods used to exhibit the ‘switching’ mechanism of an RCD, and an electromechanical relay is one of them. It is basically a switch whose principle of operation is based on electromagnetism. Within the framework of a residual current device, this relay serves the purpose of discontinuing the power supply and it also includes sending a signal to interrupt or open the circuit. However, opting for a certain relay for the RCD could be difficult for manufacturers as this relay has to be sensitive enough to detect even milliamps and in the meantime, it has to be reliable enough to prevent nuisance tripping. The sensitivity can be analyzed with the example that a residual current device with 30 mA of rated residual current value is capable to feed its secondary circuit with only a fraction of mW (milliwatt). Hence, to prevent RCDs from accidentally tripping, the relays that trigger them are often closed and held in place with the help of a permanent magnet. When a fault is sensed and residual current



is generated, the produced magnetic field will be greater than the one holding the relay in the closed position (because of permanent magnet), eventually forcing the relay to open the contacts and not returning to its normal (closed) position. The magnetic effect forcing the relay armature can be explained by the following equation (2.1) and also graphically presented in Figure 5,

$$F_{\text{armature}} = \frac{B_{\text{flux}}^2 \times A_{\text{cross}}}{2 \times \mu_0} \quad (2.1)$$

where:

F_{armature} – magnetic force acting on relay armature,

B_{flux} – magnetic flux density,

A_{cross} – cross-sectional area effected by magnetic flux,

μ_0 – vacuum permeability.

Two types of relays are generally seen inside the circuitry of an RCD which are:

- Polarized relay,
- Non-polarized relay.

Polarized relay internal circuit has been shown in Figure 5. As shown, this kind of relay operates on the principle of polarity. In a typical residual current device, a current transformer constantly monitors the current that is passing through the live and neutral conductors. A polarized relay incorporates a relay coil that is engineered using a permanent magnet or alternative methods to establish a distinct polarity within the relay [21], [22]. The polarity is configured to align with the anticipated direction of current flow in typical circumstances. When a defect arises, residual current flows (after transformation by current transformer) through the relay – the current in one half of the sine wave strengthens and in the other half weakens the force of the permanent magnet. When the weakening half of the sine wave has sufficient level, the resultant force is sufficient to pull away the armature from the yoke and eventually resulting in the opening of relay circuit. In the case of polarized relay, the secondary current's direction has a direct effect on the operation of relay as it is associated with the force of permanent magnet [23], [24].



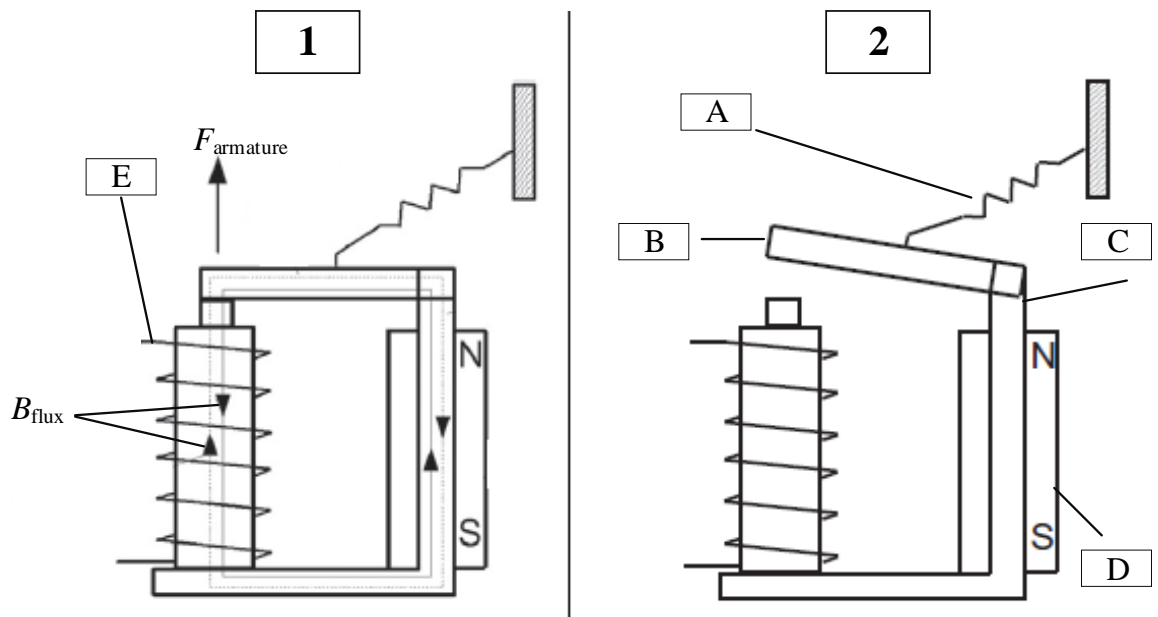

Figure 5: Structure of polarized electromechanical relay; 1: The stage of electromechanical relay before tripping, 2: The stage of relay after tripping; A – spring, B – moveable armature, C – yoke, D – permanent magnet, E – coil of current transformer.

The operation and mechanism of non-polarized relay has been explained in Figure 6. The operational behavior of non-polarized relay is slightly different, as in the absence of a residual current (normal condition), there is a constant magnetic flux rotating inside the relay that is being produced by the permanent magnet. As soon as there is a residual current inside the relay, secondary flux will be generated, that usually blocks the path of primary flux being produced by the permanent magnet (to keep the armature in closed position) [25]. Hence, the secondary flux weakens the flux of permanent magnet to such an extent that spring's force will overcome and pull the armature up to the opening position of relay. This relay is non-polarized as the direction of current has no influence on the tripping of this relay [26]. The force of the spring (F_s) can be described with the help of following equation (2.2):

$$F_s = k \times X_{\text{spring}} \quad (2.2)$$

where:

k – spring constant,

X_{spring} – displacement of the spring.

The description of the spring force (F_s) is presented in Figure 6 as well. It is crucial to note that the design and features of RCDs, including the type of relay used, might vary among manufacturers and specific models. The choice of relay technology, whether polarized or non-polarized, depends on specific parameters such as the desired sensitivity, reliability, and cost considerations for a particular application [27].



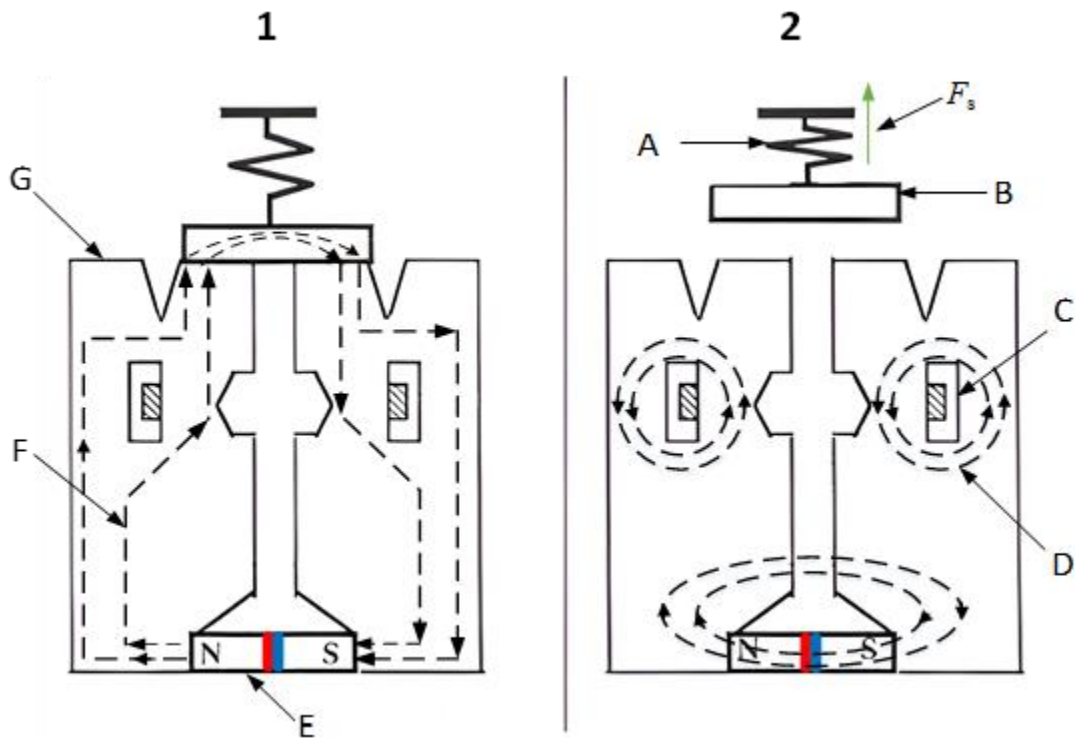

Figure 6: Structure of non-polarized electromechanical relay; 1: The stage of electromechanical relay before tripping, 2: The stage of relay after tripping; A – spring, B – moveable armature, C – trigger coil, D – flux produced by coil's winding, E – permanent magnet, F – flux produced by permanent magnet, G – yoke.

2.2.2 Current transformer

Second most important component of any residual current device can be named as summation current transformer (C.T). The main purpose of the summation current transformer is to detect the presence of residual current either in the case of insulation failure or due to the direct contact of an individual with the live part of the conductor. Under normal circumstances, the current in the live part and neutral should be equal and there must be no difference. As soon as there is a fault such as current leaking towards ground, which can be through a person or any other path, there will be a slight difference between both currents. Once the predefined threshold is crossed, it results in the further operation of an RCD. The sensitivity and threshold of current transformer is quite dependent on the material used to manufacture that C.T [28], [29]. In order to minimize the losses such as material losses and power losses, the primary winding of C.T is usually comprised of a single turn only. Moreover, it is emphasized during the design of summation current transformers, that they should be able to respond to and transform even a very small amount of current received at the primary side of the core. Its principle majorly relies on Kirchhoff's laws, as explained in equation (2.3), which states that the algebraic summation of currents entering and leaving the node must be equal to zero [30], [31].

$$\sum I_{in} = \sum I_{out} \quad (2.3)$$



where:

I_{in} – referring to the current entering the node,

I_{out} – the current leaving the node.

However, in case of fault, the current will not be the same and the difference in currents will produce a magnetic flux in the iron core of the transformer. [32]

Most manufacturers claim the magnetic field strength of 15 mA/cm or 4 mA/cm for permeability of iron core of transformer. Most of the iron core transformers used in RCDs are composed of alloys such as Ni-Fe and some nano-crystalline alloys. The material used for composition is directly linked to the permeability of current transformer and this permeability exhibits the transformation quality of residual current to secondary side of transformer. The most commonly used RCDs are AC-type and A-type with rated residual operating current of 30 mA ($I_{\Delta n}$) and the material composition for this type has been presented in Table 1. It can be seen from the Table 1 that Ultraperm being a crystalline material has quite high level of permeability. The quality of residual current signal transformation on secondary side is directly linked to the value of permeability. If RCD has a high permeability material used for the construction of its current transformer's core, the better it is for very low quality residual current signals. Such cores produce enough magnetic field to ensure the reliable tripping of the residual current during a faulty scenario. The internal circuitry (example model) of a current transformer has been shown in Figure 7.

Table 1: Current transformer composition material used for the RCD type AC and type A [33].

Type of RCD	Residual current of RCD (mA-rated), $I_{\Delta n}$	Range of Permeability	Composition material
Type AC	10–100	100,000–200,000	Ultraperm10
		200,000–300,000	Ultraperm200/250
	10–100 (capacitor in series)	125,000	UltrapermF60
		145,000	Vitroperm800F
Type A	10–100	110,000	UltrapermF80
		135,000–160,000	Ultraperm800F

Furthermore, when there is involvement of DC current, there is a slight change in the configuration and concept of the current transformer. As pulsating DC current has literally very low production of magnetic field and current on secondary side. So, in some cases, a series capacitor has to be introduced on the secondary side of transformer in order to improve the quality of residual current signal. The capacitor gets charged and basically assists in

improving magnetic induction, it is the specific time span of pulsating DC when the waveform signal hits the zero axis/line. In that interval, series capacitor discharges itself and provides enough magnetization to the relay of the circuit and capable of producing enough voltage to initiate the tripping mechanism. The relation of voltage to charge can be explained as follows in equation (2.4):

$$V = \frac{Q}{C} \quad (2.4)$$

where:

V – the voltage required to initiate tripping mechanism,

Q – referred to as charge of the capacitor and C is the capacitance.

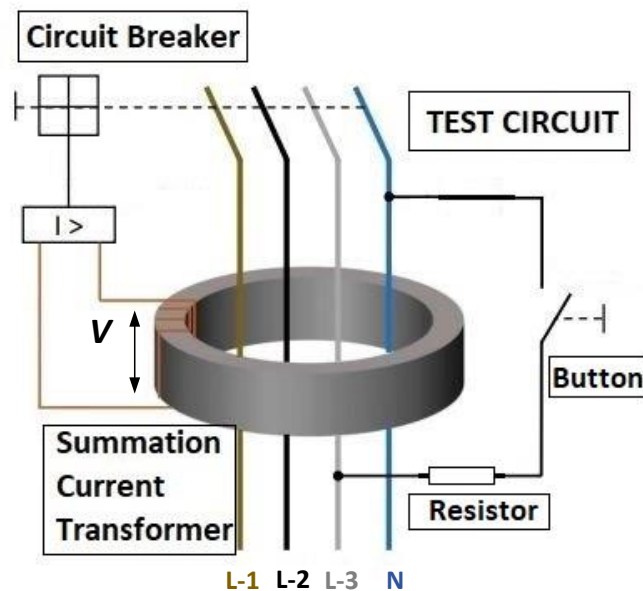

Figure 7: Internal circuitry of a current transformer of a residual current device; V – secondary voltage of current transformer; V – secondary voltage of current transformer.

However, the recent models of RCD available on the market are not voltage dependent and do not actually require any auxiliary voltage supply to ensure reliable tripping. Instead, manufacturers prefer to use two current transformer cores in one residual current device. Among those two cores, one is responsible for AC and pulsating residual current detection and other is responsible for pure or smooth DC detection. It is because even in the case of DC with a pulsating waveform, there is enough magnetization to ensure a signal transformation to the secondary of the core and eventually to the relay, but for smooth DC, there is a dire need for a dedicated iron core current transformer with certain parameters. The generated magnetic flux (Φ) in core, due to the difference in current during a faulty condition is presented in equation (2.5).

$$\phi = B_{\text{flux}} \times A_{\text{cross}} \quad (2.5)$$

where:

B_{flux} – density of magnetic flux,

A_{cross} – cross-sectional area of core.

Figure 8 explains the modern residual current devices having two iron core transformers.

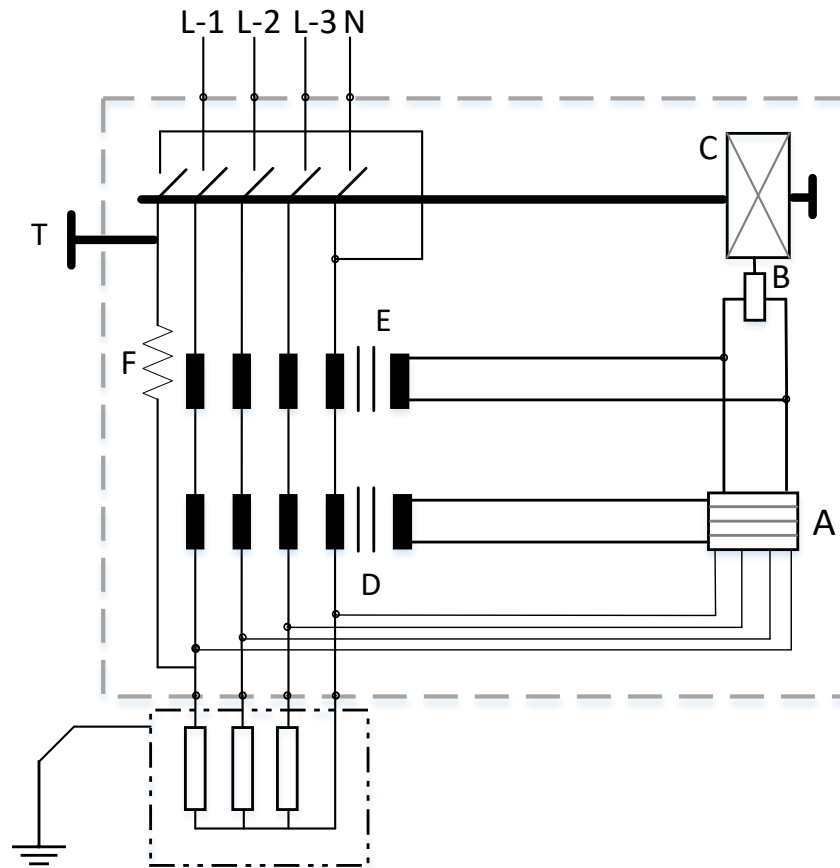

Figure 8: Modern two – iron core transformer RCD for AC residual current, smooth and pulsating DC earth fault residual currents; A – relay dedicated for smooth DC, B – relay, C – switching equipment, D – current transformer (for smooth DC), E – current transformer (for AC and pulsating DC), F – current limiting resistor for testing circuit.

2.2.3 Built-in testing circuit

Built-in test circuit of the RCD is introduced specifically for such devices which are not in operation for a quite lengthy time span and there is a great probability of malfunction or ‘insensitivity’ of the device. In such conditions, the residual current device needs to be tripped a few times to ensure its reliability during real problem [34]. Mostly, this problem occurs due to armature being stuck in closed position for months or years. To overcome this issue, manufacturers have presented a ‘test’ button on the exterior of residual current devices and it is mostly colored differently or labelled to indicate its real purpose. In this way, tripping of the device is initiated and it’s generally recommended to repeat this phenomenon after 6 months.

In the earlier RCDs, construction of this built-in testing circuit was quite simple and it had its own separate winding on the current transformer but it had adverse effects on the power losses because of excessive heat dissipation. Some examples of early testing circuits are presented in [26]. However, modernized RCDs operated without any additional winding. Instead, by pressing the test button of RCD, there is a short-circuit between the phase wire and the neutral wire situated on parallel sides of the summation current transformer. This phenomenon leads to the unbalancing of current transformer's potential, thereby triggering the tripping circuit. Standard [2] suggests that upon pressing the test button, RCD should trip regardless of the direction of current flow inside the circuitry of the residual current device. Apart from this, in order to protect the resistor connected along with the testing circuit, there is a mechanism that disconnects the testing circuit in the event of RCD tripping. The value of current injection in the case of test button being pressed is always greater than rated residual current of the certain device, usually it is 2.5 times of $I_{\Delta n}$. This testing phenomenon just ensures the mechanical reliability of the residual current device and it's not a guarantee that RCD will trip during the real exposure of fault or not. The nominal range of voltage for the testing circuit is around (0.85–1.10) in relative units. Figure 4 and Figure 8 explains the connections of the testing circuit.

2.3 Types and characteristics of residual current device

Residual current devices can be categorized into number of types depending upon the place of installation and operational characteristics. However, some are explained in this section that have a direct impact on the tripping of the RCD. The most important selection criteria should refer to the fault waveforms expected in the objective circuit.

2.3.1 Types with respect to operational characteristics

Table 2 explains the types of RCDs with respect to their detection capability of certain waveforms. The most commonly used type of RCD is AC-type because of its easy availability and being economically affordable, but AC-type is incapable of detecting mixed-frequency earth-fault currents, smooth direct current, or pulsating direct current. It is only designed to detect pure sinusoidal residual current waveform. To counter this issue, A-type RCD is usually recommended, A-type's capability to detect the aforementioned nature of residual current is better than that of AC type. Such currents are quite common in today's power network because of a lot of electronic equipment's induction in electrical systems. If correct selection of the type is not done, the RCD may not be able to ensure electric shock and fire safety [31], [35], [36], [37], [38], [39], [40], [41].

Table 2: Types of RCDs with respect to operational characteristics.

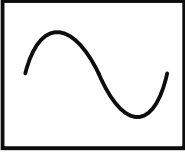
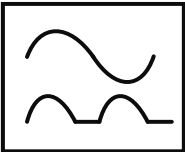
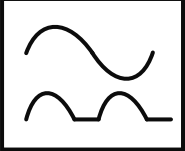
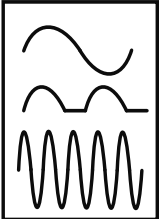
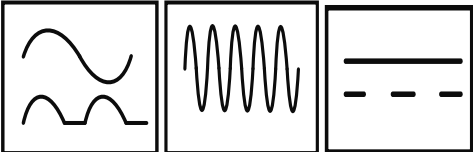
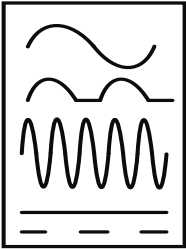
Alphabetical and graphical expression	Residual current waveform shape eligible to be detected
 or AC	<ul style="list-style-type: none"> - Sinusoidal alternating current (50/60 Hz)
 or A	<ul style="list-style-type: none"> - Sinusoidal alternating current (50/60 Hz) – same as AC-type In addition, <ul style="list-style-type: none"> - direct current (pulsating) - direct currents (pulsating) with smooth component not surpassing 6 mA
F  or 	<ul style="list-style-type: none"> - Same as A-type RCD, In addition, <ul style="list-style-type: none"> - pulsating direct currents with smooth component not surpassing 10 mA, - alternating residual currents with harmonic component fed from single phase source
B  or 	<ul style="list-style-type: none"> - Same as for type F, In addition, <ul style="list-style-type: none"> - sinusoidal alternating currents with frequency up to 1000 Hz, - alternating currents superimposed with 0.4 times (of rated current) of smooth direct current - smooth direct currents - pulsating direct current superimposed with 0.4 times (of rated current) of smooth direct current or 10 mA, (the highest value will be applicable) - direct residual currents while being in connection with circuits that include rectifiers. However, the circuits are limited such as: <ul style="list-style-type: none"> - two-pulse bridge converters for line-line connections - six-pulse bridge converters and three-pulse star connections

However, one thing that needs to be emphasized here, even A-type RCD isn't enough to ensure protection against electric shock, especially when there is an involvement of residual current composed of high-frequency earth-fault components or a major presence of DC superimposition. For this type of residual current, usually F-type RCD is recommended where there is a probability of high-frequency earth-fault current. Again, F-type RCD doesn't provide protection when smooth DC is involved. Then comes the most advanced type of RCD and the most expensive one too, B-type RCD. In addition to having the characteristics of F-type RCD, B-type RCD can support the detection of smooth direct current as well [2], [42], [43], [44].

2.3.2 Rated residual operating current

Another important decisive factor for the installation of RCDs is their rated residual operating current $I_{\Delta n}$. This is the permissible current value upon which the device should trip/operate under certain circumstances. The recommended level, according to [2], [44], of rated residual current is as follows:

6 mA – 10 mA – 30 mA – 100 mA – 200 mA – 300 mA – 500 mA – 1 A – 2 A – 3 A – 5 A – 10 A – 20 A – 30 A.

The most common value found in the daily life circuits is 30 mA. However, the value of the rated residual current should be chosen very wisely. It should be the lowest (possible) but not so low as to cause nuisance tripping and unwanted shutdowns, for example, in the case of leakage current. The higher the value, lower will be the sensitivity of the device and vice versa. High value devices, such as 10 A or 20 A are not to be used domestically, rather preferred for industrial circuits.

2.3.3 Rated frequency

In most cases, the rated frequency of the residual current devices is 50/60 Hz. For Poland, the rated frequency is 50 Hz for all kinds of devices. However, in certain cases, residual current devices with rated frequency of 400 Hz are recommended, for example, in aircraft industry. It was also noted that, if the frequency of the circuit is raised, the tripping current also increases (in kHz) and sometimes goes beyond the permissible range. The same is true when the frequency drops below the range (5 Hz or 10 Hz), which also affects the tripping circuit negatively. Many studies have proven this theory [45], [46], [47].

2.3.4 Rated voltage and its connection with number of poles

Rated voltage of RCD is needed to be either equal to the nominal voltage of the circuit (230 V in Poland) or higher than the nominal voltage level. But it shouldn't be higher than 20% of the

nominal value. Moreover, the testing circuit (TEST-push button) should also comply with this requirement. Table 3 explains the rated value for voltage and connection with poles.

Table 3: Types of RCD and their voltage ratings with respect to number of poles [2], [48].

RCD type	Source circuit description	Voltage ratings
4-pole	3 phase-4 wire system (230/400 V)	400 V
3-pole with three/four current passages	3 phase-3 wire or 4-wire system (230/400 V, 400 V)	400 V
2-pole	1-phase: phase-neutral, phase-phase, phase-earthed conductor	230 V
	1-phase: phase-phase (single phase), phase-phase (3-wire)	400 V
	3-phase: 4-wire system (230/400 V phase-neutral and 230 V phase-phase)	230 V
1-pole with two current passages	1-phase: phase-neutral, phase-earthed conductor	230 V

2.3.5 RCDs with delayed tripping

Under certain circumstances, there is a need for delayed tripping of the RCD. Such as in order to avoid nuisance tripping when there is a presence of a leakage transient currents specifically in the circuits with power electronic equipment and also in the case of underground cables. To counter such issues, two types of RCDs with delayed tripping are available on the market. Table 4 explains the symbols and the capacity to resist transients.

1. Short delay:

With delay time of 10 ms and marked with letter G. A good example of this type of RCD is B and F-type devices that have the tendency to resist inrush or transient residual currents for 10 ms.

2. Delay:

With the delay time of 40 ms and marked with letter S. These RCDs are mostly used in distribution circuits.

Figure 9 presents time-current characteristics and a brief comparison between normal and delayed tripping residual current devices.



Table 4: Symbols and inrush current capacity [49], [50].

Symbol on RCD	Explanation
G , KV, HI or VSK	RCD with short delay and can resist the transient residual current up to 3 kA up to 10 ms.
S	RCD with more delay and can resist the transient residual current up to 5 kA up to 40 ms.

2.4 Permissible limits defined in standards

Residual current device installation and erection depend on multiple factors, the decisive values are compared with state-of-art standards which are usually formulated after extensive research and investigation. The most commonly cited and used standard is IEC/HD 60364, which is devoted to low-voltage electrical fittings. Some important recommendations made by this standard can be applied while opting for a residual current device in certain installations and environments. However, this topic states some of the most important ones that are linked to the author's research. Table 5 presents some defined limits in the aforementioned HD/IEC standard.

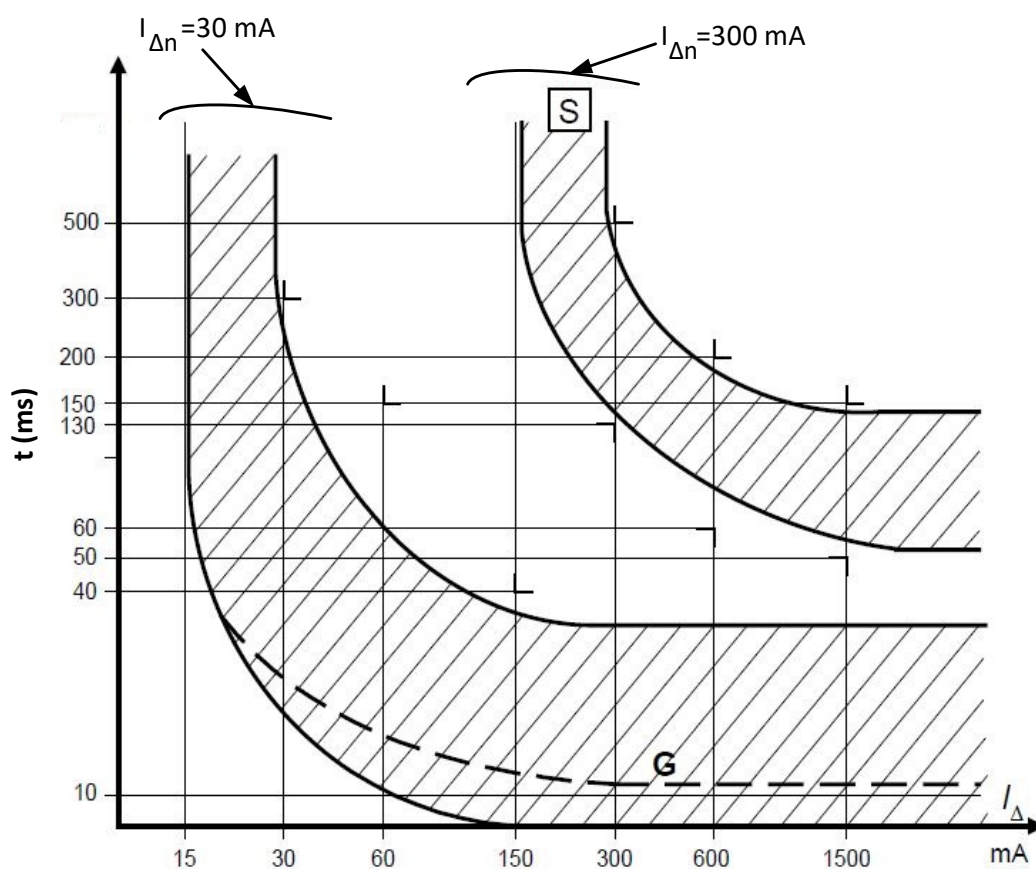

Figure 9: Time – current characteristics for two types of RCDs; without delay RCD or short delay (with symbol G): $I_{\Delta n} = 30$ mA; RCD with delayed tripping (with symbol S): $I_{\Delta n} = 300$ mA [51].

Table 5: Limits for rated residual operating current explained in IEC/HD standard.

Standard	Explanation of limits
HD 60364-4-41:2017 [1]	<p>This sub-clause states that RCD with rated residual operating current of 30 mA should be installed to fulfill extra safety requirement in following circuits:</p> <ul style="list-style-type: none"> A. All socket-outlets (AC power-plug), up to 32 A of rated current, meant to be generally used by an ordinary individual B. Portable AC appliances with rated current up to 32 A that also have outdoor applications.
	<p>The sub-clause states that additional safety must be ensured by using an RCD with a maximum tripping current of 30 mA at the end of circuits containing lighting load (luminaries) in individual household premises.</p>
IEC 60364-5-53:2015 [52]	<p>The clause states that an RCD with a maximum residual current of 300 mA must be installed with circuits carrying a fire risk. It emphasize the installation of the device near circuit's source (origin).</p>
HD 60364-7-701:2007 [53]	<p>All circuits of places containing a shower or bath should be protected by one or more RCD with rating not exceeding 30 mA.</p>
HD 60364-7-710:2012 [54]	<p>Sub-clause explains that for group 1* & group 2** medical locations, A-type or B-type RCDs are to be used depending upon the residual current's waveform.</p>
	<p><u>TN system</u></p> <p>The clause explain that group 1 medical locations/circuits having rated current up to 32 A, must be protected by residual current devices of rating up to 30 mA,</p> <p>for group 2** locations, RCDs with rating not exceeding 30 mA, are limited to certain circuits such as:</p> <ul style="list-style-type: none"> A. operating tables supply B. X-rays C. for equipment with power rating more than 5 kVA.
	<p><u>TT system</u></p> <p>For group 1* & group 2** medical location/circuits, the regulations for installation of RCDs are same as TN system.</p>
HD 60364-7-712:2016 [54]	<p>The sub-clause states that PV circuit needs to be protection with a B-type RCD except certain conditions, such as:</p> <ul style="list-style-type: none"> A. inverter exhibits a complete isolation between DC and AC parts, B. transformer exhibits a complete isolation between DC and AC parts, C. recommended by the manufacturer that there is no requirement of B-type RCD installation.
HD 60364-7-722:2018 [55]	<p>All parts of electric vehicle supply has to be protected by at least A-type RCD with rated residual current not exceeding 30 mA.</p>
	<p>The sub-clause states that a circuit installed with vehicle charger recommended by EN 62196, in such case protection against DC earth fault current will be provided by:</p> <ul style="list-style-type: none"> A. F-type RCD and RDC-DD (residual direct current detection device), B. A-type RCD and RDC-DD (residual direct current detection device), C. B-type RCD.

*Group 1: location where objective equipment is meant to be involved with individual's body externally.

**Group 2: location where objective equipment is meant to be involved in life-saving treatments such as operating table and intracardiac procedures etc.

2.5 Electric shock protection

2.5.1 Time constraint

To ensure electric shock protection, as per standard IEC 61140 [13], hazardous conductive parts of electrical network must not be accessible and accessible live parts must not be hazardous. According to aforementioned statement, all electrical installations must fulfill this obligation. In the case of fault (current path to ground), the standard could usually be followed by one of the following procedures:

1. automatic disconnection of supply,
2. double or reinforced insulation,
3. electrical separation for the supply of an item of current-using equipment.

In order to ensure the automated disconnection of the supply from the faulty circuit and provide protection against electric shock, usually RCDs are recommended [30], [56], [57]. But this recommendation has further conditions that need to be fulfilled to ensure individual's safety. The most important one is operating time of RCD as per standard HD 60364-4-41. The time limits defined in the aforementioned standard are briefly explained in Table 6. This time limit explained in Table 6 can only be implemented on certain circuits, such as:

1. the rated current of current-using equipment circuit (final circuit) must not exceed 32 A,
2. the rated current of socket-outlet circuit must not exceed 63 A.

Table 7 explains the maximum tripping current needed in a permissible time and is stated in standard IEC 61008-1:2010 [2] regarding RCDs presence as protection devices. The time limit in table 7 is designated to specific range of voltage level, $120 < V \leq 230$.

Table 6: Time of isolation stated by standard HD 60364-4-41 [1].

Low-voltage earthing system	$120 < V \leq 230$		$230 < V \leq 400$		$V > 400$	
	AC	DC	AC	DC	AC	DC
TT	0.2 s	0.4 s	0.07 s	0.2 s	0.04 s	0.1 s
TN	0.4 s	1 s	0.2 s	0.4 s	0.1 s	0.1 s



Table 7: RCD’s tripping current in connection with permissible time.

Permissible time	Maximum current upon which RCD isolates the circuit					
	Without or short delay			With delay (with S symbol)		
	B	A	AC	B	A	AC
5 s	$2 \times I_{\Delta n}$	$2 \times I_{\Delta n}$	$I_{\Delta n}$	$2 \times I_{\Delta n}$	$1.4 \times I_{\Delta n}$	$I_{\Delta n}$
1 s	$2 \times I_{\Delta n}$	$2 \times I_{\Delta n}$	$I_{\Delta n}$	$2 \times I_{\Delta n}$	$1.4 \times I_{\Delta n}$	$I_{\Delta n}$
0.4 s	$2 \times I_{\Delta n}$	$2 \times I_{\Delta n}$	$I_{\Delta n}$	$4 \times I_{\Delta n}$	$2.8 \times I_{\Delta n}$	$2 \times I_{\Delta n}$
0.2 s	$4 \times I_{\Delta n}$	$4 \times I_{\Delta n}$	$2 \times I_{\Delta n}$	$4 \times I_{\Delta n}$	$2.8 \times I_{\Delta n}$	$2 \times I_{\Delta n}$

2.5.2 Electric shock protection in TN system

TN system is the most favorable earthing technique for smooth operation of residual current devices. TN system means that the transformer’s neutral has a direct connection with earth, moreover, frame is also connected to neutral point. That dedicated earth protection usually installed is made up of a metallic component. Because of such metallic path, a high value of earth fault current is usually attained and hence easier for RCDs to act positively during fault scenario. As far as the further classification of TN system is concerned, RCDs can only be utilized in the case of TN-S. In TN system, the relationship between loop impedance and tripping current can be characterized as:

$$I_{(tripping)} \times Z_{(source)} \leq V_{(nominal)} \tag{2.6}$$

where in equation (2.6),

$I_{(tripping)}$ – tripping current with constraint of time,

$Z_{(source)}$ – earth fault loop impedance,

$V_{(nominal)}$ – nominal voltage (line to ground).

For TN-C system, there is no possibility for the recognition of residual current. All of the earth fault current is diverted to PE (protective earthing) and N (neutral) conductors. All the generated residual current passes through the PEN conductor which is a joint of PE and N conductors. Hence, almost no current travels through the RCD to create appropriate amount of flux necessary for initiation of RCD’s tripping. Moreover, to ensure the fair tripping and reliability of connected RCD, the method of connection is quite important. For example, an unintended connection of PE conductor with N conductor divides the earth fault current path into two parts. It eventually has a negative effect on the sensitivity of RCD [57], [58], [59].

2.5.3 Electric shock protection in TT system

TT means that the electrical system's neutral has a direct connection with local earthing conductor and unlike TN system, in TT the frame has a connection with earth. In this system, the fault current has to pass through earth conductor and real earth. This configuration suggests that the fault current's path may possess a high impedance, resulting in the delay of traditional overcurrent protection mechanisms, like fuses or circuit-breakers, from promptly identifying and ceasing earth faults. RCDs are essential for providing protection in this situation. TT's system safety protocol can be ensured by fulfilling the following:

$$I_{(\text{tripping})} \times R_{(A)} \leq 50V \quad (2.7)$$

where in equation (2.7),

$R_{(A)}$ – sum of the resistance of the earth electrode and the protective conductor,

$I_{(\text{tripping})}$ – tripping current with a constraint of time.

RCDs provide personal protection independently of the earth loop impedance, making them beneficial in TT systems with potentially high impedance. RCDs in TT systems may trip frequently (nuisance tripping) due to transient earth faults or electrical noise. Hence, it's quite important while opting for a proper type of RCD with appropriate sensitivity and employing efficient circuit design can help mitigate this issue in TT system configuration. In most cases, comparatively low sensitivity RCDs are proposed to mitigate the issue of unwanted tripping. It can be achieved either by using 500 mA RCD or those with a certain delay such as tripping up to 1 s. [60], [61].

2.5.4 Electric shock protection in IT system

The IT earthing system has slight challenges when it comes to installing residual current devices, unlike TT and TN systems. This system is characterized by the electrical installation being either isolated from the earth or having a connection to the earth through a high impedance. Furthermore, the fault current in IT system is of a capacitive nature. This system is frequently used in environments where continuous power supply is essential, including hospitals, industrial facilities, and certain naval applications. IT system protection surety can be fulfilled by the following relation:

$$R_{(A)} \times I_{(\text{fault})} \leq 50 V \quad (2.8)$$

where in equation (2.8),

$R_{(A)}$ – sum of the resistance of the earth electrode and the protective conductor,

$I_{(\text{fault})}$ – refers to first fault's earth fault current.

This IT system configuration prevents the initial grounding fault from producing a current of significant intensity to activate the tripping of residual current device, hence preventing any



interruption to the power supply. However, this advantage comes with an increased risk of secondary fault causing a serious short-circuit, potentially leading to equipment damage or electric shock if not promptly addressed. RCDs must be carefully selected for their sensitivity to accurately identify possible earth faults in an IT system without causing unnecessary tripping or endangering the system's real purpose, unless the IT system is designed in such a way to counter fire/explosion threat.

2.5.5 Effects of electric shock on human body

In particular cases, additional or backup protection is necessary for high-powered devices like drill machines and places that have a higher probability of electric shock, such as outdoor electrical switches and connections, where rainwater can be problematic. To counter these hazards, highly sensitive RCDs are to be connected as additional protection along with primary RCDs connected with main circuitry boards. According to report [62], the disconnection times or the sensitivity of the RCD are derived from a few tests. The standard IEC TS 60479 [63] explains the effects of current passing through a human body (from left hand to feet). The whole scenario has been divided into four zones:

- Zone-1,
- Zone-2,
- Zone-3,
- Zone-4.

The explanation has been given in Figure 10 which depicts all zones. In zone-1, no human reaction is usually expected as the amount of current is too low to be hazardous. However, in zone-2, it might be possible that a slight reaction is observed such as, muscular contraction, but no hazardous electric physiological reaction is expected. Such reactions are expected in zone-3 where severe muscular contractions can occur along with difficulty breathing. Moreover, this amount of current can cause severe disturbances in heart rate. Finally, zone-4, can be extremely hazardous for humans and can cause severe burns and heart rate irregularity which can eventually results in cardiac arrest. The zone-4 is further subdivided into sections in which probability of ventricular fibrillation increases simultaneously with each section which is 5% for zone-4A that goes up to more than 50% in section zone-4C. It is important to note that human exposure to hazardous electric shocks can be more fatal when the exposure time is increased. This is one of the many reasons that the application of RCD with $I_{\Delta n} = 30 \text{ mA}$ is very important and emphasized in standards as well. These RCDs are taken as additional protection and considered extremely important to avoid and save humans from serious electric shock effects while having a direct contact. Direct contact may include contact with a live

conductor, in this case, as there is no insulation failure so circuit-breaker won't be able to detect such a minute amount of current; say 30 mA. However, above 30 mA it can be extremely fatal for a human body and only properly selected RCD can prove useful in such cases.

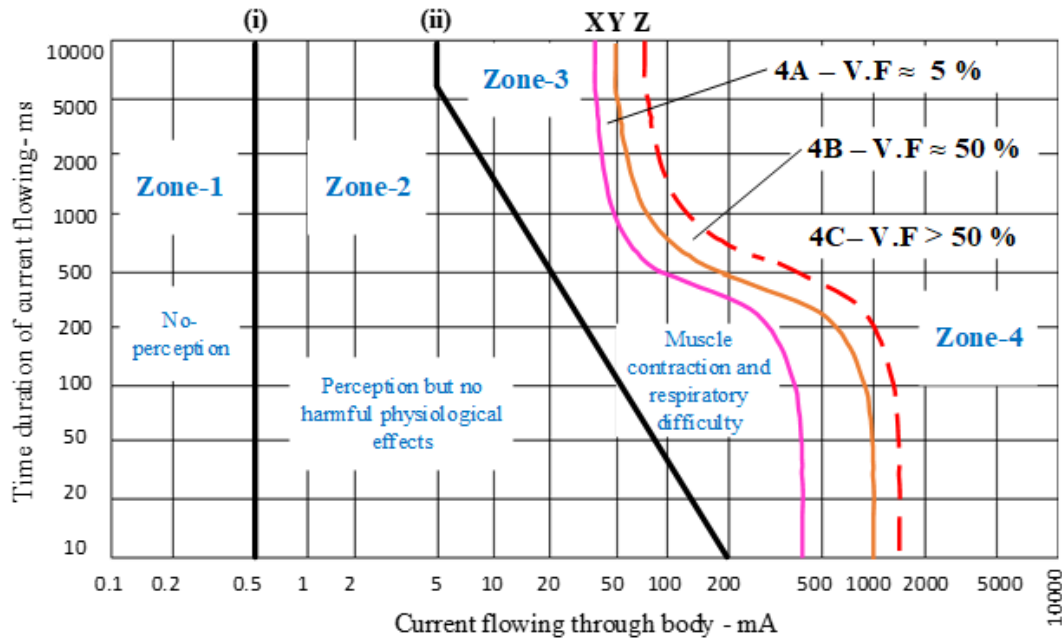

Figure 10: Time – current characteristics for effects of AC current (15-100) Hz on humans; V.F – ventricular fibrillation; based on [62].

2.6 Fire protection

Electrical fires can occur due to insulation problems and presence of leakage current in the circuit. It can also occur due to overheating from overloaded or inadequate connections and most important is arcing produced by damaged wires or equipment. Residual current devices are designed to detect and prevent abnormalities in the electrical current flow, offering an effective way to reduce the risk of fires caused by electrical faults [7], [45], [64].

In order to prevent such accidents, following measures can be adopted to ensure fire protection:

- Insulation degradation can lead to electrical fires by causing earth faults that may not generate enough current to activate a typical circuit-breaker. RCDs can detect these faults early and disconnect the power supply before temperature of the installations reaches a dangerous level.
- RCDs primarily detect earth leakage currents but can also help mitigate the effects of arc faults resulting from damaged cables or weak connections producing intense electrical arcs. A residual current device can interrupt the circuit upon detecting an imbalance, especially in situations where an arc fault leads to leakage currents.

2.6.1 Fire protection from leakage current

Leakage currents in electrical systems can produce thermal energy (heat) that can create a major safety hazards, including the risk of fire. Thermal power is generated when leakage currents flow through resistive materials, this may lead to the heating of equipment or conductors due to electrical resistance. Minor leakage currents in electrical systems can generate enough heat to damage the insulation, melt conductors, or trigger flammable materials if not timely managed and rectified. This heat being produced by the leakage current can be mathematically described as follows:

$$P_{(\text{thermal})} = V_{(\text{nominal})} \times I_{(\text{leakage})} \quad (2.9)$$

where:

$P_{(\text{thermal})}$ – thermal power (heat) produced due to the current passing through resistive channel,

$V_{(\text{nominal})}$ – it can be dedicated as nominal voltage (line to ground),

$I_{(\text{leakage})}$ – leakage current of the circuit.

RCDs may detect quite low value leakage currents, enabling them to respond to potentially hazardous leakages, thereby preventing fires by detecting and stopping circuit leakage current before it can generate sufficient thermal power to ignite materials or damage equipment. Table 8 shows the maximum thermal power values possible in circuits with RCDs of certain rated residual operating currents.

Table 8: Power (thermal) generated by leakage current.

Line to ground voltage of network	RCD's rated residual current	Power (thermal)
230 V	30 mA	7 W
	100 mA	23 W
	300 mA	69 W
	500 mA	115 W
400 V	30 mA	12 W
	100 mA	40 W
	300 mA	120 W
	500 mA	200 W

Standard HD 60364-4-42:2011 (Sub-clause 422.3.9) [65] presents the highest amount of residual operational current that can be used in 230/400 V low-voltage networks. Final circuits and current-using equipment in hazardous (prone to fire) regions must be protected against insulation faults according to the following specifications:

- RCDs with an $I_{\Delta n}$ of 300 mA or lower are required to be inducted in TN and TT systems. However, 30 mA or lower can be placed in situations where resistive faults, like overhead heating with heating film elements, may pose a fire risk.
- Insulation monitoring devices (IMDs) or residual current monitors (RCMs) equipped with an audible and visual alert system must be inducted in IT systems to monitor insulation or residual current in the final circuits. However, for an alternative, if RCD needs to be installed, it can be on the same provisions as for TN and TT system.

The provisions of standards, in order to ensure fire protection, hence claim that the RCD with 300 mA (or less) of rated residual current needs to be inducted at the source of the circuit. According to table 8, 300 mA value lies against 69 W of thermal power, hence 69 W is the maximum permissible thermal power in a circuit with nominal voltage of 230 V. However, RCDs may not always effectively provide protection against fire in all the cases, there are certain scenarios where RCD may not identify some types of insulation failures, despite real fire hazards. This is the worst-case scenario when the insulation-to-earth in each phase is in a deteriorated state. In such cases, the resultant value is often near zero or too low to be detected by the RCD.

2.6.2 Fire protection from arcing

Electrical arcing is a significant fire hazard in electrical systems. Arcing is the occurrence of an electric current passing through a vacuum between conductors or from a conductor to the ground. This can happen due to damaged insulation, weak connections, or when conductive materials are near electrical conductors. An arc's high temperature can easily ignite nearby flammable objects, leading to flames. Standard IEC 62606:2013 [66], states following types of arc faults:

- parallel arcing— a parallel arc phenomenon usually occurs between two different conductors as the name suggests such as between two phase conductors. Insulation failure can result in the occurrence of such an arc [67],
- earth arcing—such arc can happen when current travels from a live conductor towards the earth. This arc unintentionally creates an unintentional current passage towards

ground and could result in the heat dissipation in significant amount. That heat can further result in a fire hazard [68],

- series arcing— series arc occurs when there is an arcing phenomenon happening in the single conductor of the network. The reasons may include, broken wire, or could also be cracked conductor inside a cable. Weak or loose connections can also result in this type of arc. If there is no timely interruption, electrical current continues to flow through the arc, generating significant amounts of heat [69].

In these aforementioned circumstances (except series arcing), the fault current is usually high enough to be detected by the miniature circuit-breaker (MCB). Also, during occurrence of earth fault arcing, the fault current often surpasses the value of load current and hence any overcurrent diagnosing mechanism can provide protection in such cases, specifically RCD can detect the earth arcing phenomenon.

However, the case of series arc faults is quite different from the rest of the aforementioned events. In the case of series arcing, (as mentioned before) the arc fault is present on a single conductor and rest of circuit remains unaffected by series arcing. This incident can certainly happen in the case of damage to the conductor during construction work or excessive pressing/bending of the objective conductor. The worst thing about series faults is that arc fault current is usually equivalent to the load current of the circuit. Hence, undetectable by any overcurrent protection device such as MCB or also by the RCD because there is no residual current in this case. The solution to the series arcing issue has been proposed by the standard IEC 62606:2013 [66] in the form of AFDD (arc fault detection device). In the absence of AFDD, the continued usage of damaged of cables/conductors may cause further deterioration of the insulation and the arcing (series) may cross the insulation of the equipment to the surrounding flammable equipment [70], [71], [72].

2.7 Sinusoidal and non-sinusoidal residual currents

Sinusoidal residual current is an alternating current that deviates from minimum (zero) to maximum (peak) and again from maximum (peak) to minimum (zero) and maintains the desired balanced flow between the live and neutral conductors in an electrical system, this phenomenon is also known as ‘zero crossing’. In an ideal condition, if there is some outflow of current from the circuit, this current signifies a leakage or fault scenario, where current deviates from the designated circuit path, either passing through an individual, the ground, or a malfunctioning equipment. This current was supposed to follow its dedicated path entirely through the neutral conductor. The term "sinusoidal" stresses the importance of leakage

current which exhibits a nominal, wave-like pattern in AC systems, fluctuating consistently above and below the neutral point in a continuous rotation.

The detection of sinusoidal residual current is relatively easier and ensured as compared to non-sinusoidal residual current, specifically when the purpose of detection is solely linked to the tripping of the RCD. Whenever the scenario of fault arises, the balance between the line and neutral current will be disturbed. RCDs must be selected as per the potential waveform shapes of the residual current and also according to the equipment used in the circuit. This is because the reliable operation of an RCD depends on how well the transformation of residual current is carried out by the current transducer [73], [17], [74], [75], [76], [77]. If RCDs are not carefully selected for the specific circuit, the device may not be able to detect the fault current. For example, table 2, explains the criteria for RCD's selection with respect to the tentative waveform, if a rectifier or a frequency converter has been installed in a circuit, a simple AC-type relay may not be able to initiate the tripping for such residual current waveform. This is because the current transducer inside the AC-type RCD lacks the properties to detect and transform the residual current other than 50 Hz pure sinusoidal. This topic reviews the non-sinusoidal residual current and its impact on RCDs.

2.7.1 Rectified residual current waveform

Unidirectional waveforms of earth fault current are anticipated in both residential and commercial electrical installations due to the extensive use of electronic devices that involve rectifiers. The residual current that is most difficult to detect by an RCD is the one with smooth (DC) residual current waveform. Example residual current waveforms are explained in Chapter 3, where it can be observed that such waveforms (smooth) for DC earth fault current are no longer in the domain of A-type RCD or AC type RCD. Although A-type RCDs have the properties to detect DC components with a smoothed part with maximum 6 mA value but the explained results in aforementioned Chapter 3 present a strange and different behavior. Rather, these kinds of waveforms maybe detectable to some extent only by B-type RCDs and that too conditionally. A series of tests have been performed to verify the behavior of market-available RCDs, including all types (A, AC, B, F) of 30 mA as rated residual operating current ($I_{\Delta n}$). All the testing and results have been explained in this dissertation in the upcoming chapter 3 [78].

2.7.2 Distorted residual current waveform (harmonics)

Unwanted currents known as distorted or harmonic residual currents may develop in electrical systems when nonlinear equipment and variable speed drives (VSD) are attached to the network. These VSDs may contain a multi-layered electronic circuit that includes inverter,

rectifiers and DC components. Due to the introduction of such circuits in the electrical system, normal sinusoidal waveform of the network is disrupted. In faulty cases, even the earth fault current is made up of such distorted waveforms also known as harmonics. Moreover, the equipment whose operation is dependent on the phenomenon of pulse width modulation (PWM), may also inject harmonics or interharmonics in the system, that is, the multiple of fundamental frequency (50/60 Hz). The RMS value of harmonic and fundamental component can be calculated using the following expression:

$$I_{\text{RMS}} = \sqrt{I_1^2 + \sum_{n=2}^{\infty} I_n^2} \quad (2.10)$$

where in equation (2.10),

I_{RMS} – root mean square (RMS) value of current,

I_1 – amplitude of fundamental harmonic component,

I_n – amplitude of n^{th} harmonic component.

Apart from VSDs, the devices responsible for the generation of harmonics in our daily lives, are computer power supplies, LED lights, and other electronic equipment that do not utilize the power in a continuous pattern but rather in short, high-intensity pulses. An example of harmonics is given in an upcoming chapter 3.

The ability of RCDs to identify residual current based on harmonics is mainly dependent on the type of RCD installed in the circuit. Moreover, it is dependent on the amount and sequence of harmonic components involved/imposed on the residual current waveform.

The main function of AC-type RCD is to respond to the residual currents of sinusoidal AC, this type of RCD may not be able to detect residual currents with significant harmonic components. A-type RCDs have the capability to detect both sinusoidal AC residual currents and pulsating DC (up to an extent) residual currents. Compared to AC-type, A-type is more suitable but still tripping is not ensured even with A-type [79].

Both F-type and B-type RCDs are meant to be installed in electrical networks prone to high-frequency harmonics as well as where multi-frequency harmonics are expected [80], [81]. Both of these RCDs (as per standards) should be enough to counter residual currents of high-frequency and residual current composed of harmonics or interharmonics. Yet the operation of both RCDs is not ensured and this has been verified after a dozen tests performed in the laboratory of Faculty of Electrical and Control Engineering at Gdansk University of Technology. All of the test results are explained in the upcoming chapter 3 of this dissertation.

3 TESTING OF PRE-EXISTING RESIDUAL CURRENT DEVICES

3.1 Normative and broader scope testing

In order to verify the behaviour of RCDs, type testing is used for the verification process of RCDs. This is the way to ensure their compliance to the international standards, reliability, safety and trustworthiness in reducing electric shock and fire hazards. The main purpose of these tests is to check whether manufactured RCDs meet the requirements of IEC standards as well as possible non-standard conditions occurring in modern electrical systems. If they do not meet, the product should not be placed on the market, especially in modern electrical systems. This process is a prerequisite for the manufacturers before RCDs are marketed and installed in any electrical network.

RCDs have to be exposed to a series of testing procedures to assess their electrical as well as mechanical functioning. For this, the standards are stated in IEC 61008-1 [2] for RCDs without integral overcurrent protection (RCCBs) for household and similar cases and IEC 61009-1 [43] for RCDs with overcurrent protection (RCBOs). Moreover, for special cases, such as F-type and B-type RCDs, IEC 62423 states some additional testing requirements apart from the basic ones. Some of the most important type test are [1]:

- operational performance tests,
- mechanical durability tests,
- temperature tests,
- electrical tests (tripping characteristics),
- environmental tests.

However, among the aforementioned, this dissertation is focused on the testing mechanisms associated with electrical safety and isolation in the case of fault. This generally involves tripping verification of RCDs which is recommended by standard IEC 61008-1 and IEC 61009-1 as well. The test is usually focused on the proper tripping of the objective RCD when exposed to certain types of residual currents. It is explained in pervious chapter 2.5.1, the most commonly used method to ensure electric shock protection is automatic disconnection of source/supply. According to standard HD 60364-4-41:2017, the protective device must cut off the supply within the allotted time period in order to avoid lethal electric shock in the case of an insulation-to-earth failure. Conclusively, in this dissertation, the same method is chosen to ensure and verify the behavior of RCDs by automatic disconnection of supply.

To meet the obligation, RCDs are exposed to following tests that have been performed in the laboratory of Faculty of Electrical and Control Engineering:

- A. exposure to high-frequency suddenly applied residual current (up to 50 kHz) starting from nominal, articles [47] and [82] also present the results,
- B. exposure to suddenly applied mixed-frequency component—two frequency component—three frequency component, results published in [47] and [82],
- C. exposure to suddenly applied smooth DC component, articles [37] and [38] have been published on the said topic,
- D. exposure to slowly rising residual current from DC (0 Hz) to AC (50 kHz) [83].

The aforementioned tests have been executed and the results have been published, the references (citations) have been added in the aforementioned text (points A, B, C and D). In order not to leave any ambiguity and to be sure about the behavior of the certain type (AC, A, B and F), more than 20 RCDs of different types have been tested are produced by 7 different manufacturers. The results presented in this dissertation, are the most appropriate ones.

3.2 Response to pure sinusoidal high-frequency sudden applied residual current

Based on the observations and characteristics of real-world practical circuits that have excessive integration of power electronic converters, it is possible that the frequency of the earth fault current is much higher than 1000 Hz. As explained in [47], there is a big probability that pulse width modulation may trigger the frequency of earth fault current up to 30 kHz if the source frequency drops to 10 Hz due to any unforeseen circumstance. In this scenario, earth fault current may contain multiples of PWM frequency that can reach up to 20 kHz. The worst-case scenario will be the one with lowest motor speed with fundamental frequency of 1 Hz and there is a presence of high PWM frequency, say 6.6 kHz. In such case, the multiples of PWM frequency in earth fault current can reach up to approximately 47 kHz and this has been proven in the article [39]. Hence, all types of RCDs must be tested and their behavior has to be verified under the residual current composed of high-frequency starting from nominal (50 Hz) and going up gradually up to the frequency of (500, 1000, 2000, 5000, 10000, 20000, 50000) Hz. It is to be noted here, that the residual current of aforementioned frequencies is of pure sinusoidal nature and will be suddenly applied. This residual current has fixed values in relation to the rated residual current value of the RCD i.e., 30 mA ($I_{\Delta n}$), 60 mA ($2I_{\Delta n}$), 150 mA ($5I_{\Delta n}$), 240 mA ($8I_{\Delta n}$), 300 mA ($10I_{\Delta n}$), 450 mA ($15I_{\Delta n}$) [84].

3.2.1 Laboratory test bench

Due to the aforementioned reasons, the operation of RCD has to be verified by exposing them to very high-frequency in the lab. For this purpose, the test bench in the laboratory has been exhibited in Figure 11.

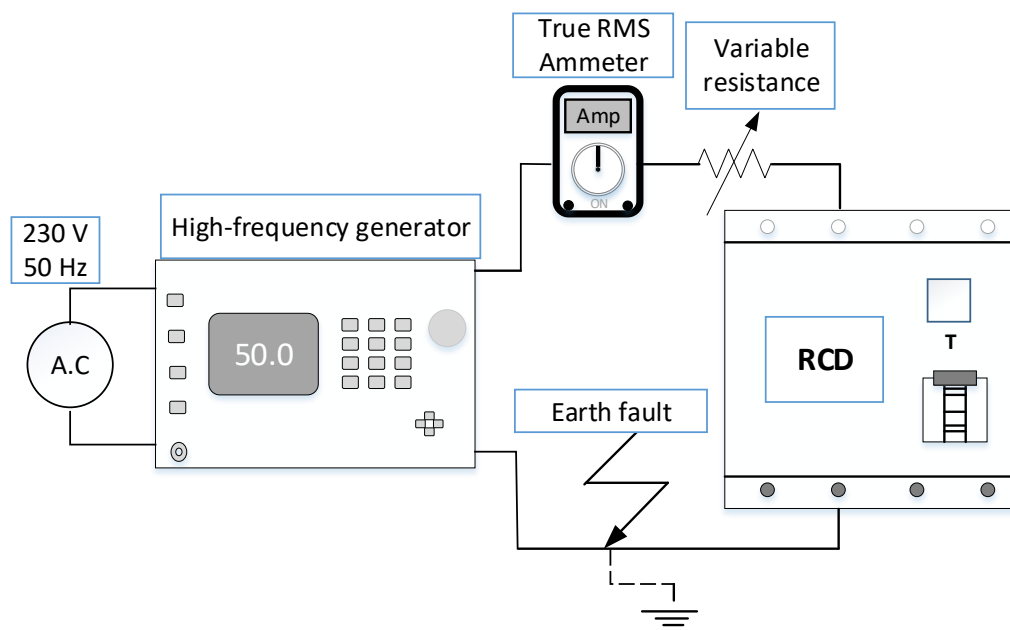

Figure 11: High-frequency laboratory test bench for RCD testing.

The following are the parts of the laboratory stand used for high-frequency testing:

- a source of 230 V, 50 Hz that powers up the high-frequency generator which is responsible for producing a residual current waveform (up to 50000 Hz),
- additionally, there is an ammeter, used to measure the real RMS value of current,
- a variable resistance, used in the circuit to attain the required residual current and to limit the chance of equipment's burning out.

3.2.2 List of tested RCDs for suddenly applied high-frequency test

Selected RCDs and their allocated codes for the aforementioned test are presented in Table 9.

Table 9: List of tested RCDs.

Type of RCD	Manufacturer	Code used in dissertation
AC-type	Mr_1	RCD_AC1
AC-type	Mr_2	RCD_AC2
AC-type	Mr_3	RCD_AC3
AC-type	Mr_3	RCD_AC4
AC-type	Mr_4	RCD_AC5
A-type	Mr_3	RCD_A1
A-type	Mr_2	RCD_A2
A-type	Mr_3	RCD_A3
A-type	Mr_5	RCD_A4
A-type	Mr_1	RCD_A5
B-type	Mr_6	RCD_B1
B-type	Mr_4	RCD_B2
F-type	Mr_7	RCD_F1
F-type	Mr_4	RCD_F2

3.2.3 Test results

- AC-type

Looking at Figure 12, the analysis of results can be done. The results obtained from AC-type RCDs of five different manufacturers conclude that AC-type RCDs from different manufacturers have different sensitivities, although of same type and characteristics. Attained results were quite disappointing and even alarming, worst results were recorded for RCD_AC4 (Figure 12D), no tripping was observed at such a low-frequency of 500 Hz and high level of residual current ($5I_{\Delta n}$). The tripping in this case (Figure 12D) was only noted with the maximum provided residual current equal to 15 times of $I_{\Delta n}$. The residual current is 15 times higher than the rated one, i.e., $30 \text{ mA} \times 15 = 450 \text{ mA}$. Slightly improved behavior was seen in the case of RCD_AC1 (Figure 12A), where tripping was recorded at higher frequencies such as up to 5 kHz but the residual current for 500 Hz to 5 kHz was higher than the rated 30 mA. Regrettably, no tripping was observed for 10 kHz and higher frequencies in any of the 5 tested RCD even for the highest provided residual current of $15I_{\Delta n}$ (450 mA). The unsatisfactory behavior of the AC type RCDs to the high-frequency tests concluded that this type (AC) of RCD is not suitable for circuits exposed to high-frequency residual currents. Specifically, even domestic circuits may be prone to such a high-frequency of residual current due to abundant use of power electronic equipment such as laptop chargers and mobile adapters. Hence, even for such basic circuits, AC-type RCD is not recommended as it won't be able to provide the ensured electric shock protection as can be seen from the tripping results of Figure 12.

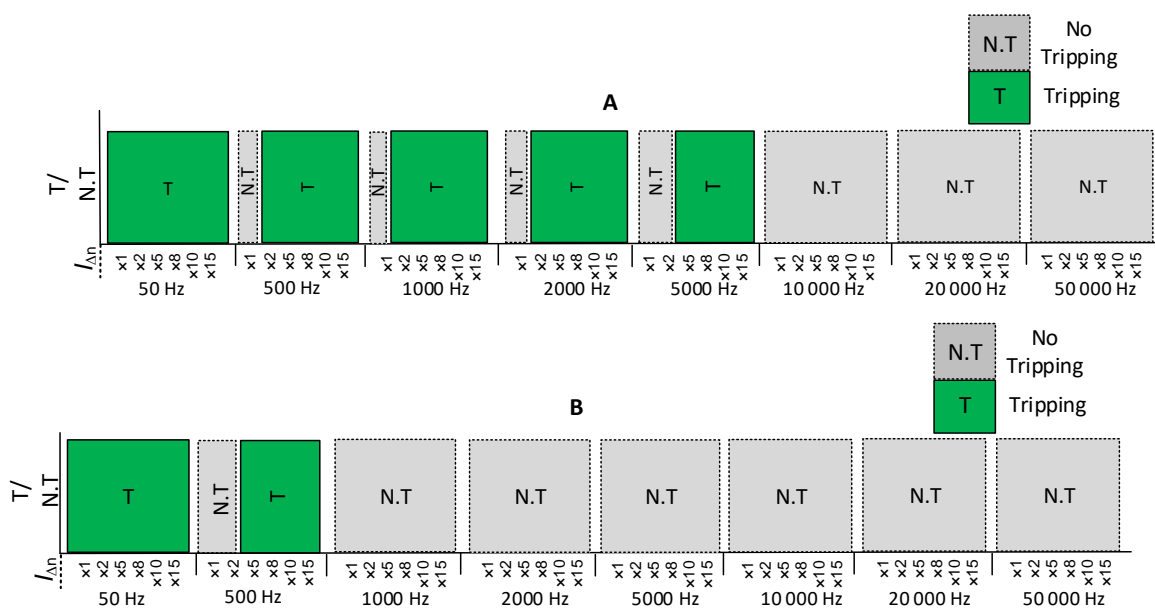

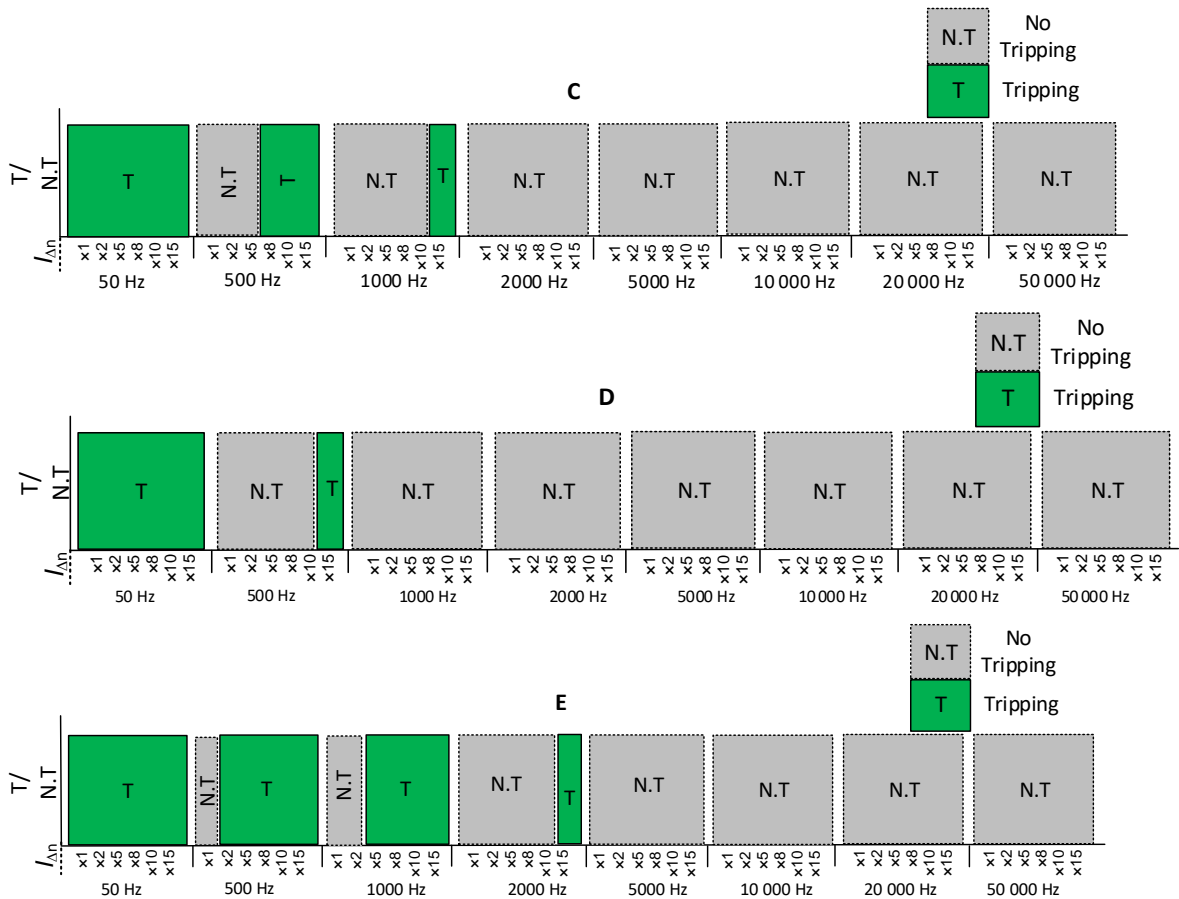

Figure 12: Test results of AC-type (30 mA) RCDs – residual current with pure sinusoidal waveform from 50 Hz up to 50000 Hz: A) RCD_AC1, B) RCD_AC2, C) RCD_AC3, D) RCD_AC4, and E) RCD_AC5.

- A-type

Looking at Figure 13, the results obtained after rigorous testing of A-type RCDs from 5 different manufacturers conclude that similar to AC-type RCDs, A-type RCDs from different manufacturers have different sensitivities, although of same type and characteristics. Just like previous results, these ones are also not very promising. All five A-type RCDs tripped normally within certain range of $(0.5-1.0)I_{\Delta n}$ at the nominal frequency of 50 Hz. Afterwards, it can be seen in Figure 13A, that RCD_A1 didn't trip at 500 Hz of frequency even with the maximum value of residual current equal to 15 times of $I_{\Delta n}$. So no reaction was observed for the rest of frequencies i.e., (500, 1000, 2000, 5000, 10000, 20000 and 50000) Hz. Almost similar outcome was seen in the case of Figure 13B and Figure 13E for RCD_A2 and RCD_A5, where both aforementioned RCDs along with nominal frequency tripped at 500 Hz at highest available residual current slot of $15I_{\Delta n}$ and depicted no tripping at other higher level frequency stages. Comparatively better results were recorded for RCD_A3 (Figure 13C) and RCD_A4 (Figure 13D). In both of these cases, RCD_A3 only tripped at 1000 Hz on 10 times of residual current provided ($10I_{\Delta n}$) but there was no reaction after 1000 Hz and RCD_A4 tripped on 2000 Hz but only in the case of highest residual current slot ($15I_{\Delta n}$) and beyond the

TESTING OF PRE-EXISTING RESIDUAL CURRENT DEVICES

frequency level of 2000 Hz, again, no reaction was observed. From the test results of Figure 13, it can be said that A-type RCD that is most commonly used RCD worldwide, is not enough to provide electric shock protection in the modern times. Under certain circumstances, A-type RCD may not be able to diagnose the high-frequency (pure sinusoidal) waveform. There is a great probability that this type of RCD may not prove effective in providing ensured electric shock protection to any individual prone to electrocution.

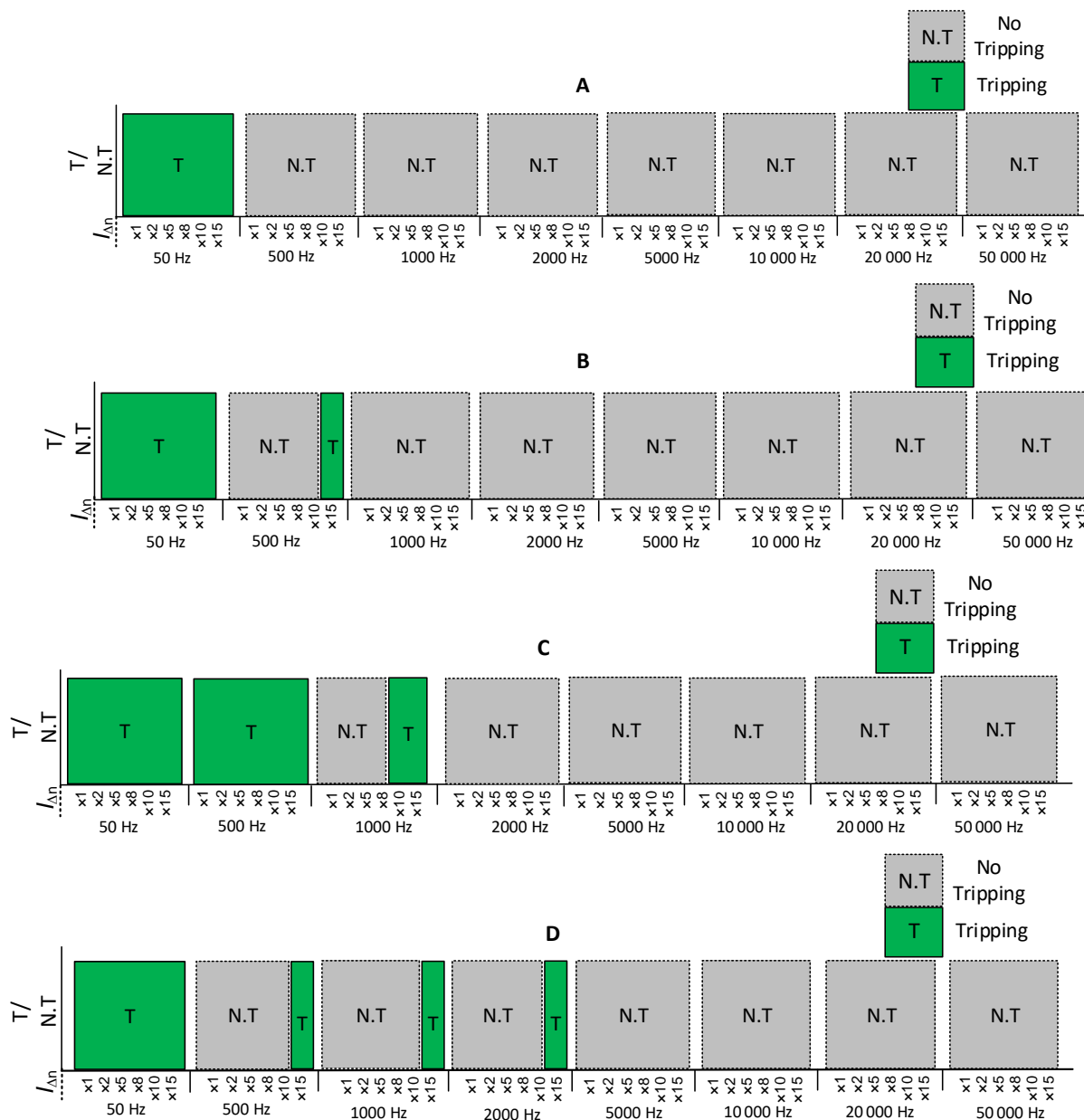

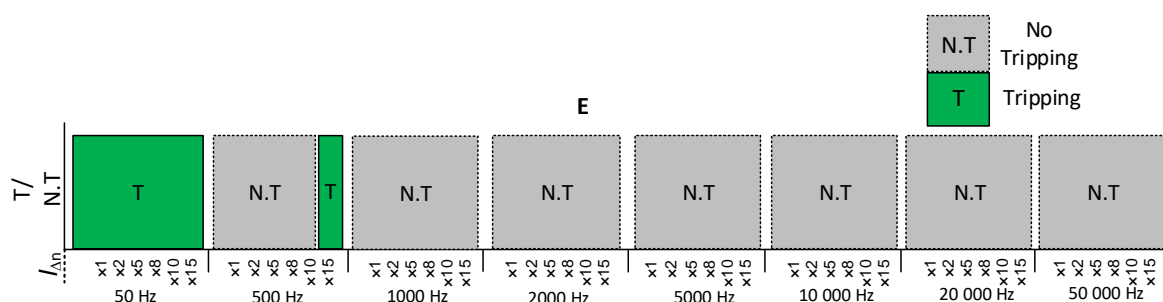

Figure 13: Test results of A-type (30 mA) RCDs – residual current with pure sinusoidal waveform from 50 Hz up to 50000 Hz: A) RCD_A1, B) RCD_A2, C) RCD_A3, D) RCD_A4, and E) RCD_A5.

- B-type

B-type RCDs are composed of a special system that needs an auxiliary voltage to fully perform its designated functions. Many renowned manufacturers such as ABB, ETI and Doepke have claimed that B-type RCD needs an auxiliary supply (AC) of minimum 50 V in order to ensure the protection with B-type RCD installed [45]. Keeping this in mind, B-type RCDs have been tested in both ways, i.e., in the presence of auxiliary supply and in its absence as well. Figure 14 and Figure 15 exhibits the recorded test results of RCD_B1 and RCD_B2 respectively, where, Figure 14A and Figure 15A represent the results of B-type RCDs including auxiliary supply and Figure 14B and Figure 15B exhibit the results of tested B-type RCDs while excluding auxiliary supply.

Although, being the advanced type of RCD, B-type RCDs didn't perform well in the case of higher frequencies. In the case when auxiliary supply was included, both RCDs, RCD_B1 (Figure 14A) and RCD_B2 (Figure 15A) didn't trip until $2I_{\Delta n}$ of rated value at 500 Hz, instead, reacted at $5I_{\Delta n}$ which is troublesome. Again for 1000 Hz, RCD_B1 (Figure 14A) showed no reaction until $2I_{\Delta n}$ and tripped at $5I_{\Delta n}$. For RCD_B2 (Figure 15A), no reaction was observed even until $5I_{\Delta n}$ for 1000 Hz of frequency. The worst case was observed in the case where no auxiliary supply was attached. Both RCDs tripped on nominal frequency (50 Hz) and after this frequency level, no satisfactory results were attained. It is visible in Figure 14B (RCD_B1), where RCD tripped only at 500 Hz at highest residual current of $15I_{\Delta n}$ and apart from this, RCD_B1 failed to show tripping at any higher frequency levels. The case of RCD_B2 (Figure 14B) was although not satisfactory but slightly better in comparison to RCD_B1, as it tripped successfully on 500 Hz and 1000 Hz at $8I_{\Delta n}$ and $10I_{\Delta n}$. RCD_B2 failed to trip at all other higher frequency levels. Despite the advanced design, high-frequency testing results of B-type RCDs were quite alarming and unsatisfactory.

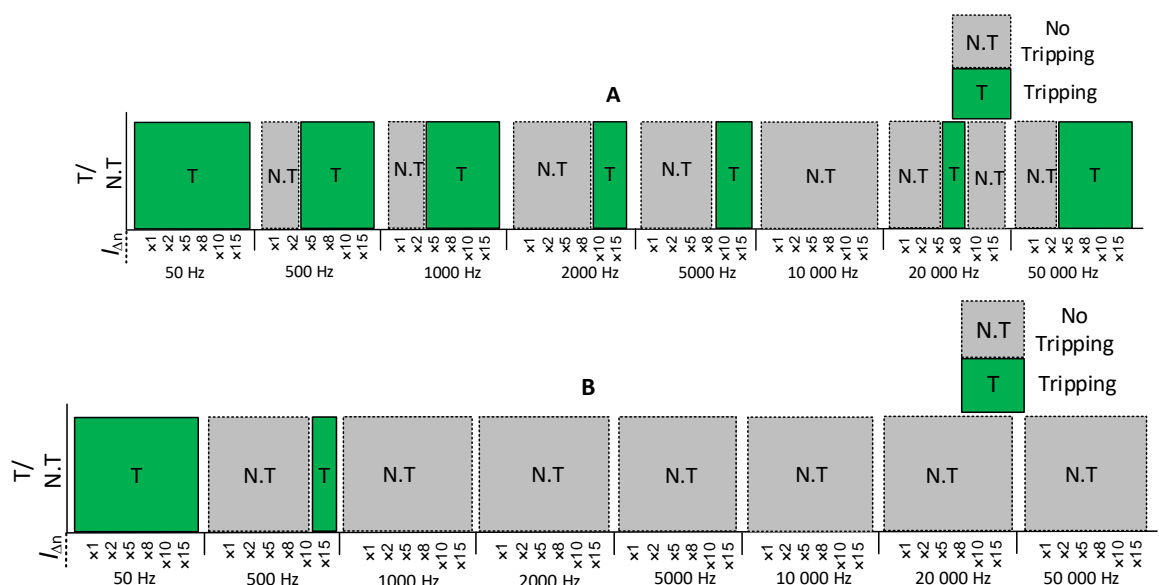

Figure 14: Test results of B-type (30 mA) RCD (RCD_B1) – residual current with pure sinusoidal waveform from 50 Hz up to 50000 Hz: A) with auxiliary supply, B) without auxiliary supply.

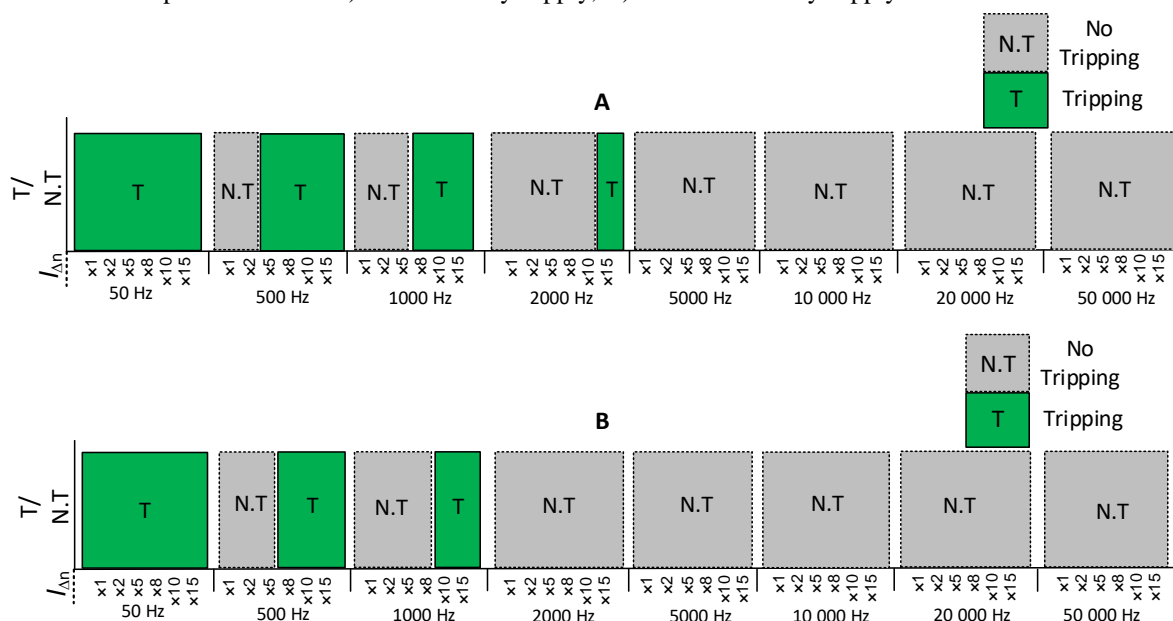

Figure 15: Test results of B-type (30 mA) RCD (RCD_B2) – residual current with pure sinusoidal waveform from 50 Hz up to 50000 Hz: A) with auxiliary supply, B) without auxiliary supply.

- F-type

The recorded test results of F-type RCDs are shown in Figure 16. Once again, the outcomes are not very promising. RCD_F1 (Figure 16A) only triggered for the nominal frequency (50 Hz), despite the fact that F-type RCDs are meant to operate efficiently at higher frequencies. When testing at higher frequencies, this RCD (RCD_F1) only responded when value equivalent to 15 times of $I_{\Delta n}$ was attained at 1000 Hz. It failed to trip at 500 Hz when the residual current value was 5 times higher and showed positive response only at $8I_{\Delta n}$. For the rest of higher frequencies, no tripping was observed in the case of RCD_F1 even for 15 times higher residual current provided to the RCD ($15I_{\Delta n}$). For the RCD_F2 (Figure 16B),

results were slightly better than RCD_F1, exhibited the same behavior at nominal frequency of 50 Hz; but initially, at 500 Hz it did not respond to residual current levels of $I_{\Delta n}$ or $2I_{\Delta n}$. On the other hand, for the frequency level of 1000 Hz, RCD_F2 only tripped at 8 times the rated residual current ($I_{\Delta n}$) and above. For 2000 Hz, it tripped only for the highest available residual current of $15I_{\Delta n}$ and above this frequency level, RCD_F2 did not trip at any value of $I_{\Delta n}$ and showed negative findings for the higher frequencies (5000, 10000, 20000, and 50000) Hz as depicted in Figure 16B.

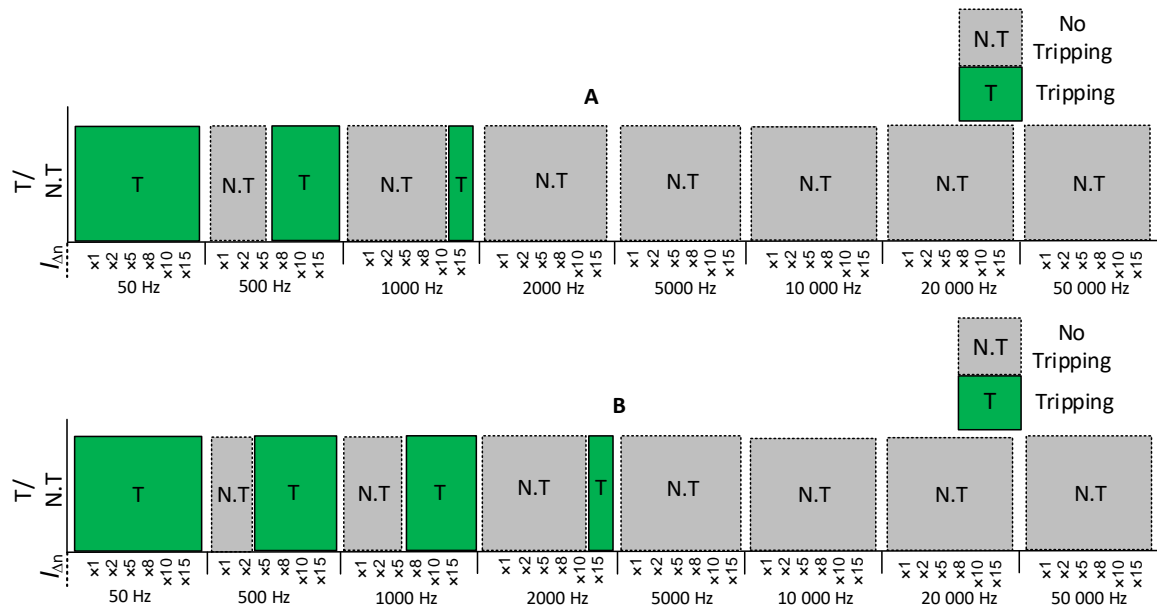

Figure 16: Test results of F-type (30 mA) RCDs – residual current with pure sinusoidal waveform from 50 Hz up to 50000 Hz: A) RCD_F1 B) RCD_F2.

3.3 Response to suddenly applied mixed-frequency components

This part of the laboratory test can be further broken down into two subdivisions:

- Two-frequency mixed waveform test,
- Three-frequency mixed waveform test.

For the two-frequency mixed waveform test, RCD’s tripping was verified in the presence of residual current composed of one high-frequency component (500 Hz) and one fundamental frequency (50 Hz). However, in order to provide a more thorough analysis of the RCD sensitivity problem, the percentage content of the low-frequency part (50 Hz) and the high-frequency part was progressively varied. An important factor to mention that the laboratory generator, regardless of the testing current values, 30 mA ($I_{\Delta n}$), 60 mA ($2I_{\Delta n}$), 150 mA ($5I_{\Delta n}$), 240 mA ($8I_{\Delta n}$), 300 mA ($10I_{\Delta n}$), 450 mA ($15I_{\Delta n}$), maintains a constant ratio of these frequency components for a preset content of the aforementioned components. The normative range of the tripping threshold for the sinusoidal waveform (50 Hz) is $(0.5–1.0)I_{\Delta n}$, however for mixed-frequency waveforms, it is $(0.5–1.4)I_{\Delta n}$ [2], [44], [48].

For the second part of testing, aforementioned mechanism was repeated but in the presence of three frequencies i.e., 50 Hz (nominal frequency) and two high-frequency components. In this case, the 50 Hz component among the three, represents the fundamental frequency of the network. The second frequency component is 150 Hz, which represents the frequency (in faulty cases) of neutral point i.e., earth to neutral voltage of the converter. Third frequency component (500/ 1000/ 2000) Hz is referring towards the converter’s behavior of switching frequency based on pulse width modulation (PWM). For the tests including high-frequency part, one of the two components is kept constant at the level of 150 Hz and the other high-frequency component is fixed at different levels such as: (500, 1000 and 2000) Hz sequentially to test the RCDs.

3.3.1 Sample waveforms

Table 10 and Table 11 present the sample waveforms that were used to test the behavior of RCDs. These waveforms were recorded with the help of devoted software. The waveforms have been denoted by a specific title in order to ease the graphic explanation of the waveforms during the representation of tripping results e.g., mixed-frequency (MF – 1A) presents the two frequency module of 90% of 50 Hz and 10% of 500 Hz and MF – 1B presents three frequency module i.e., 50% of 50 Hz, 25% of 150 Hz and 25% of 500 Hz.

Table 10: Sample waveforms for mixed-frequency tests based on two components; MF – mixed-frequency.

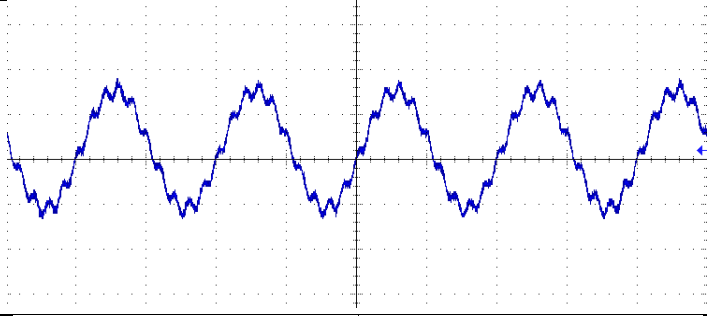
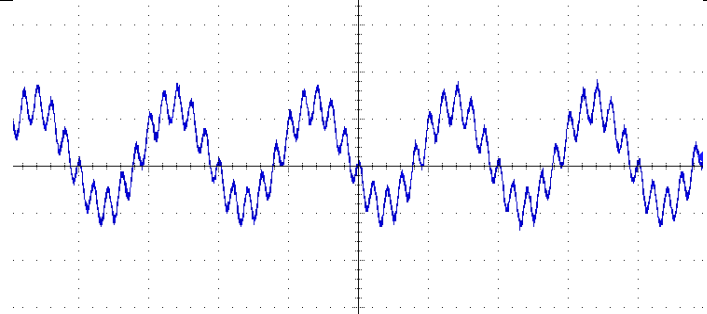
Two frequency contents/percentages	Sample of waveform generated for RCD verification
<p>MF – 1A:</p> <ol style="list-style-type: none"> 1. 90% of 50 Hz 2. 10% of 500 Hz 	
<p>MF – 2A:</p> <ol style="list-style-type: none"> 1. 75% of 50 Hz 2. 25% of 500 Hz 	

TESTING OF PRE-EXISTING RESIDUAL CURRENT DEVICES

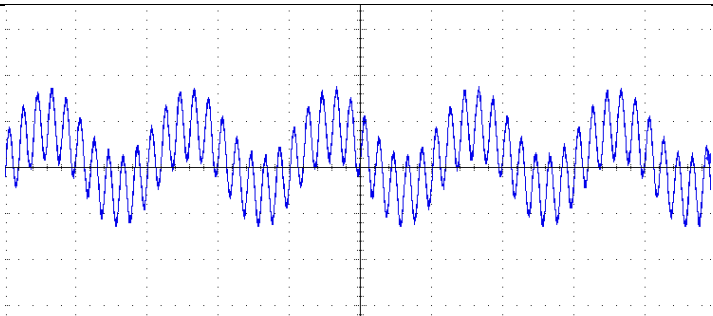
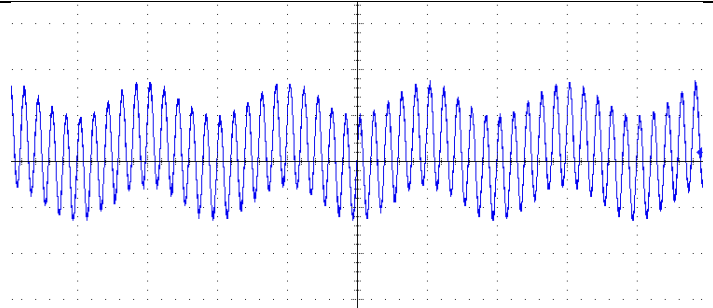
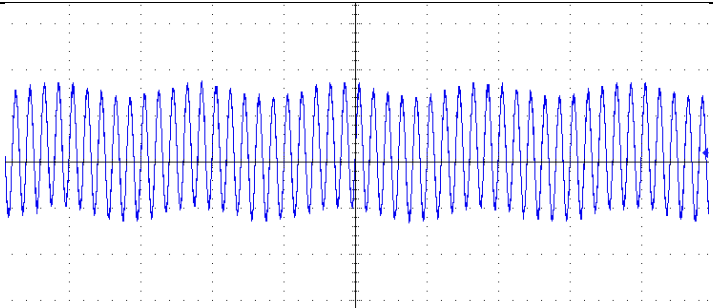
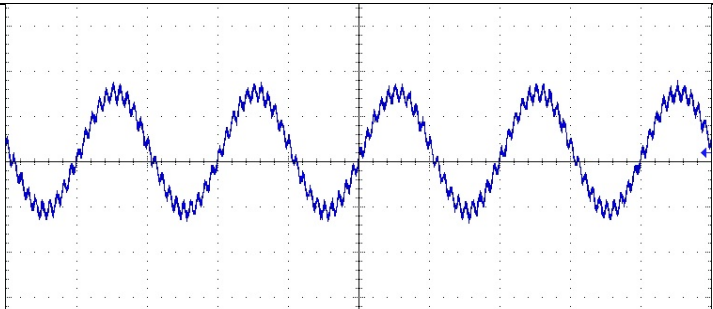
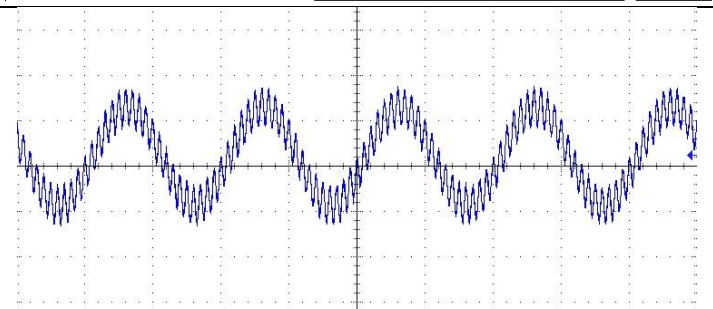
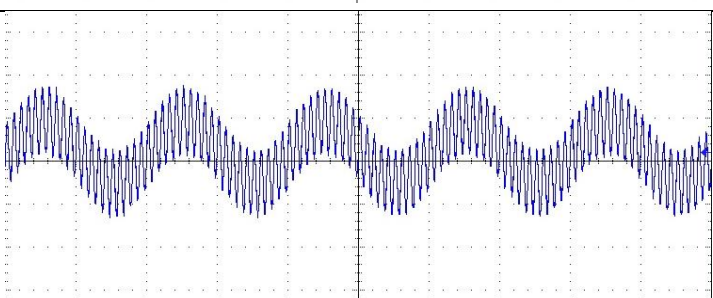
<p style="text-align: center;">MF – 3A:</p> <ol style="list-style-type: none"> 1. 50% of 50 Hz 2. 50% of 500 Hz 	
<p style="text-align: center;">MF – 4A:</p> <ol style="list-style-type: none"> 1. 25% of 50 Hz 2. 75% of 500 Hz 	
<p style="text-align: center;">MF – 5A:</p> <ol style="list-style-type: none"> 1. 10% of 50 Hz 2. 90% of 500 Hz 	
<p style="text-align: center;">MF – 6A:</p> <ol style="list-style-type: none"> 1. 90% of 50 Hz 2. 10% of 1000 Hz 	
<p style="text-align: center;">MF – 7A:</p> <ol style="list-style-type: none"> 1. 75% of 50 Hz 2. 25% of 1000 Hz 	
<p style="text-align: center;">MF – 8A:</p> <ol style="list-style-type: none"> 1. 50% of 50 Hz 2. 50% of 1000 Hz 	

TESTING OF PRE-EXISTING RESIDUAL CURRENT DEVICES

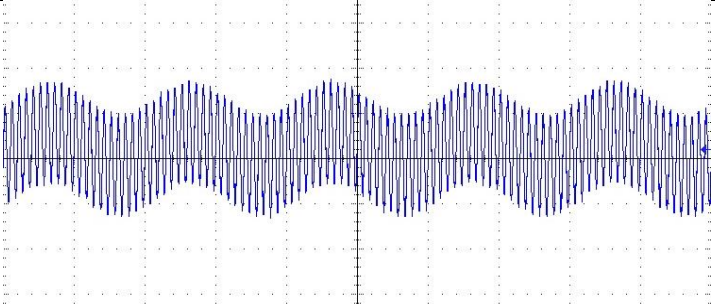
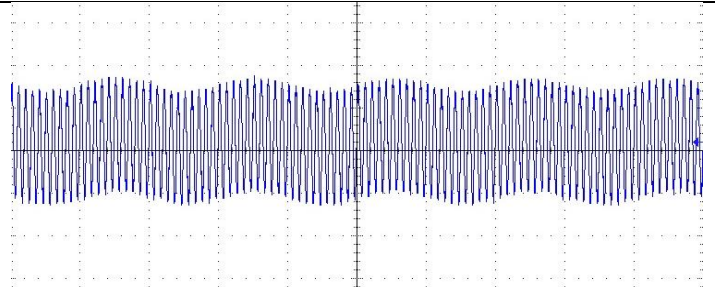
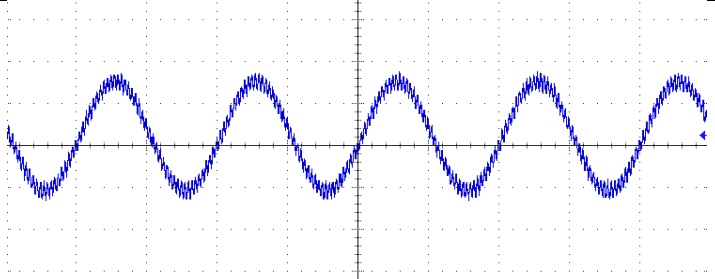
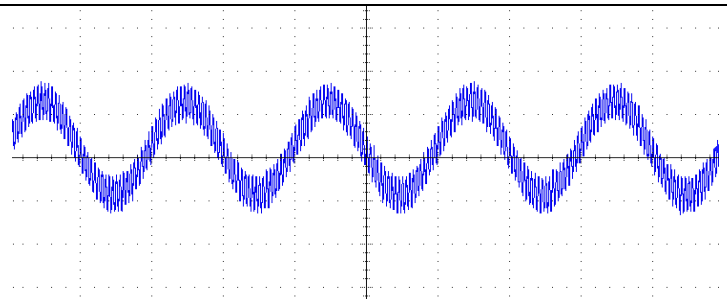
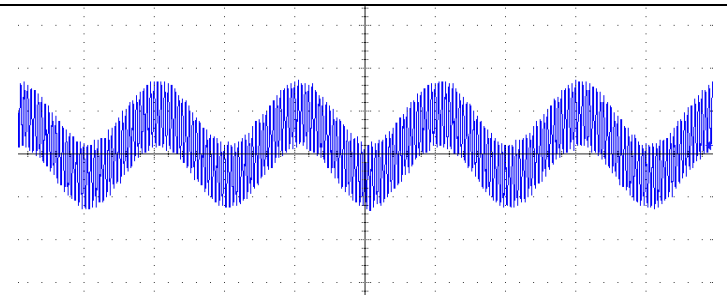
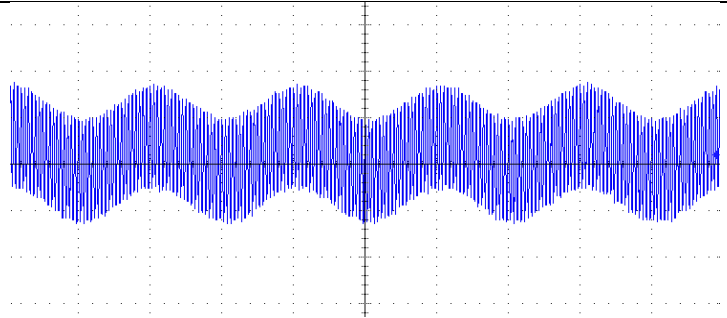
<p style="text-align: center;">MF – 9A:</p> <ol style="list-style-type: none"> 1. 25% of 50 Hz 2. 75% of 1000 Hz 	
<p style="text-align: center;">MF – 10A:</p> <ol style="list-style-type: none"> 1. 10% of 50 Hz 2. 90% of 1000 Hz 	
<p style="text-align: center;">MF – 11A:</p> <ol style="list-style-type: none"> 1. 90% of 50 Hz 2. 10% of 2000 Hz 	
<p style="text-align: center;">MF – 12A:</p> <ol style="list-style-type: none"> 1. 75% of 50 Hz 2. 25% of 2000 Hz 	
<p style="text-align: center;">MF – 13A:</p> <ol style="list-style-type: none"> 1. 50% of 50 Hz 2. 50% of 2000 Hz 	
<p style="text-align: center;">MF – 14A:</p> <ol style="list-style-type: none"> 1. 25% of 50 Hz 2. 75% of 2000 Hz 	

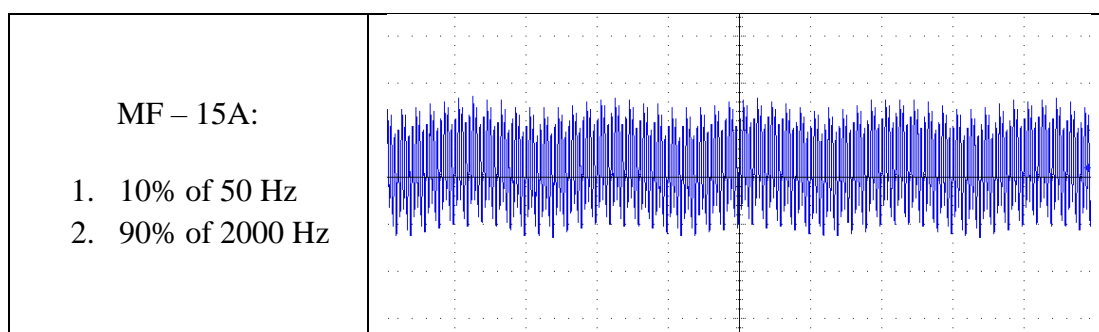
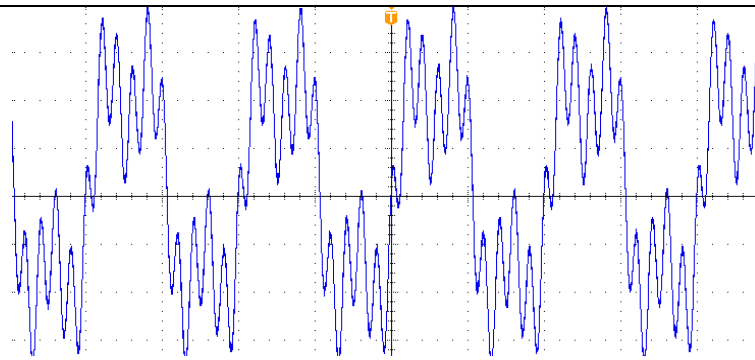
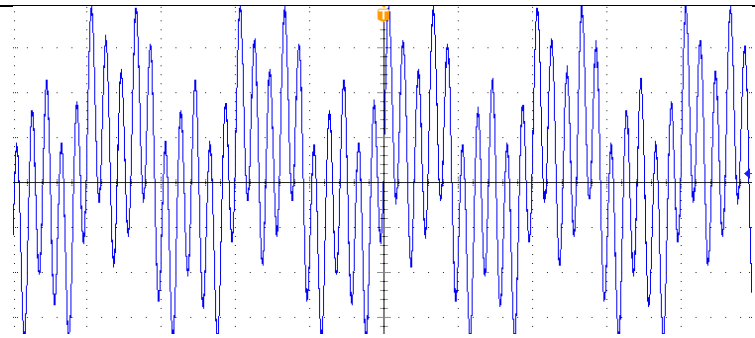
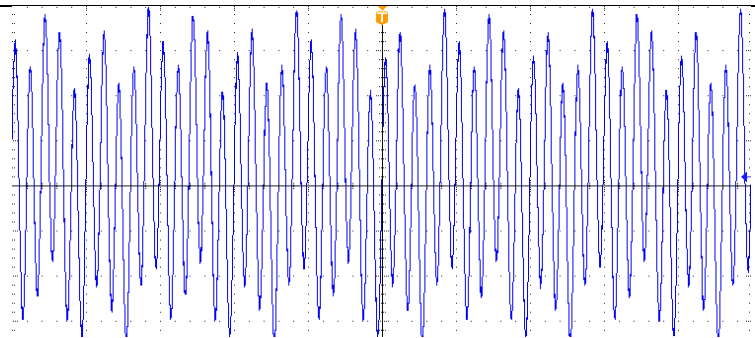
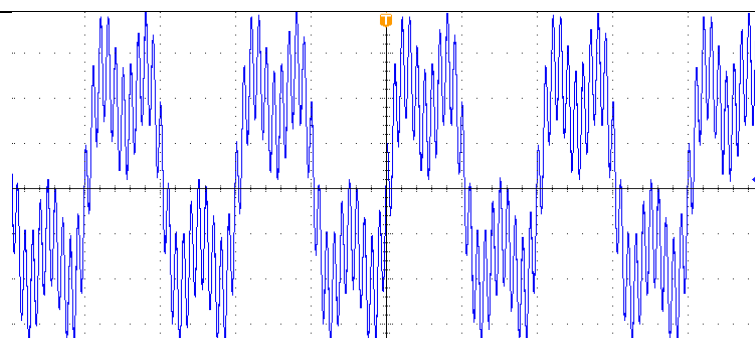
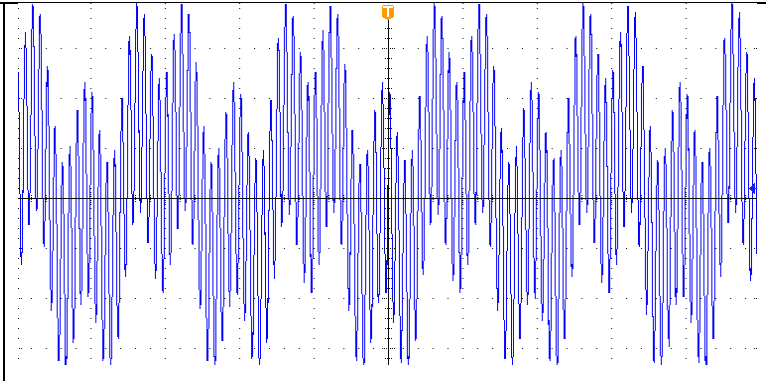
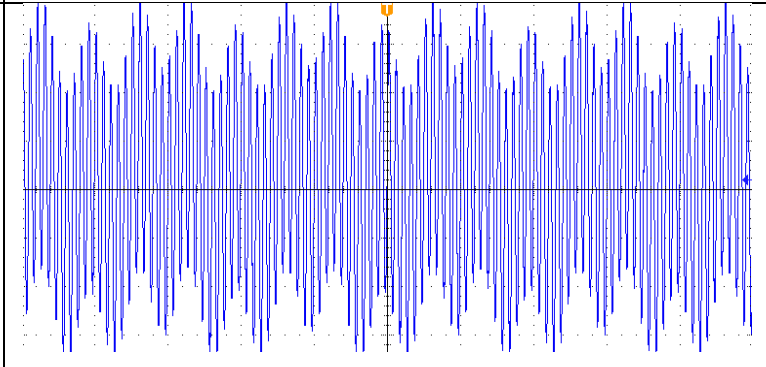
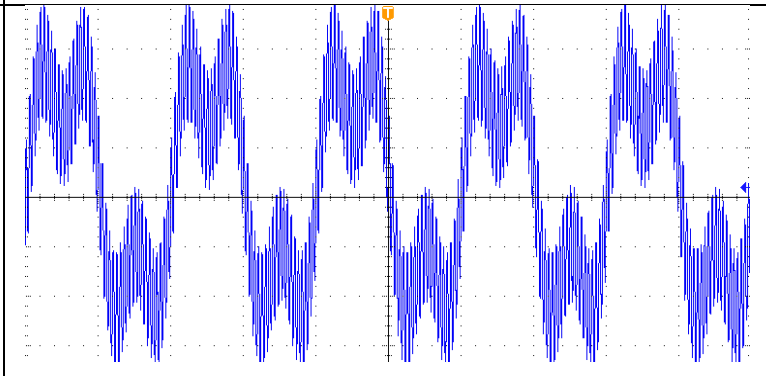
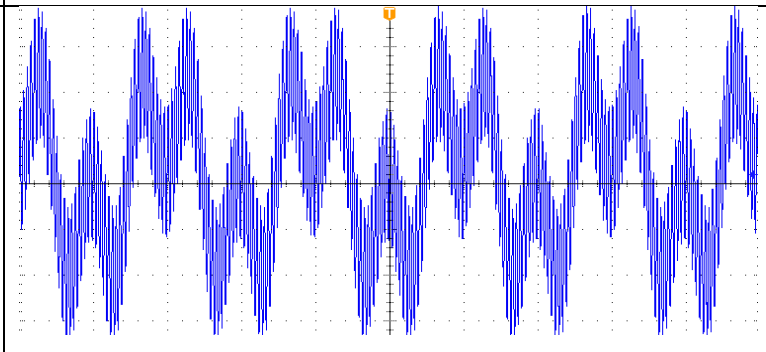
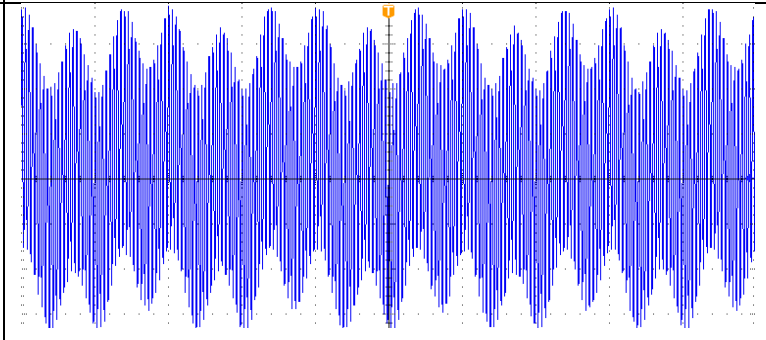

Table 11: Sample waveforms for mixed-frequency tests based on three components; MF – mixed-frequency.

Three frequency contents/percentages	Sample of waveform generated for RCD verification
<p>MF – 1B:</p> <ol style="list-style-type: none"> 1. 50% of 50 Hz 2. 25% of 150 Hz 3. 25% of 500 Hz 	
<p>MF – 2B:</p> <ol style="list-style-type: none"> 1. 25% of 50 Hz 2. 25% of 150 Hz 3. 50% of 500 Hz 	
<p>MF – 3B:</p> <ol style="list-style-type: none"> 1. 5% of 50 Hz 2. 25% of 150 Hz 3. 70% of 500 Hz 	
<p>MF – 4B:</p> <ol style="list-style-type: none"> 1. 50% of 50 Hz 2. 25% of 150 Hz 3. 25% of 1000 Hz 	

TESTING OF PRE-EXISTING RESIDUAL CURRENT DEVICES

<p>MF – 5B:</p> <ol style="list-style-type: none"> 1. 25% of 50 Hz 2. 25% of 150 Hz 3. 50% of 1000 Hz 	
<p>MF – 6B:</p> <ol style="list-style-type: none"> 1. 5% of 50 Hz 2. 25% of 150 Hz 3. 70% of 1000 Hz 	
<p>MF – 7B:</p> <ol style="list-style-type: none"> 1. 50% of 50 Hz 2. 25% of 150 Hz 3. 25% of 2000 Hz 	
<p>MF – 8B:</p> <ol style="list-style-type: none"> 1. 25% of 50 Hz 2. 25% of 150 Hz 3. 50% of 2000 Hz 	
<p>MF – 9B:</p> <ol style="list-style-type: none"> 1. 5% of 50 Hz 2. 25% of 150 Hz 3. 70% of 2000 Hz 	

3.3.2 List of tested RCDs

Selected RCDs and their allocated codes for mixed-frequency tests are presented in Table 12.

Table 12: List of RCDs tested under mixed-frequency waveforms.

Type of RCD	Manufacturer	Code used in dissertation
AC-type	Mr_2	RCD_AC2
AC-type	Mr_3	RCD_AC3
AC-type	Mr_4	RCD_AC5
A-type	Mr_3	RCD_A1
A-type	Mr_2	RCD_A2
A-type	Mr_1	RCD_A5
B-type	Mr_6	RCD_B1
B-type	Mr_4	RCD_B2
F-type	Mr_7	RCD_F1
F-type	Mr_4	RCD_F2

3.3.3 Laboratory test bench

Figure 17 presents the test equipment used to verify the behavior of RCDs mentioned in Table 12. The test bench is quite similar to high-frequency test bench except there is an addition of a dedicated software handled through a computer system. The software was used to define the percentage contents of the frequency as explained and mentioned in Table 10 and Table 11.

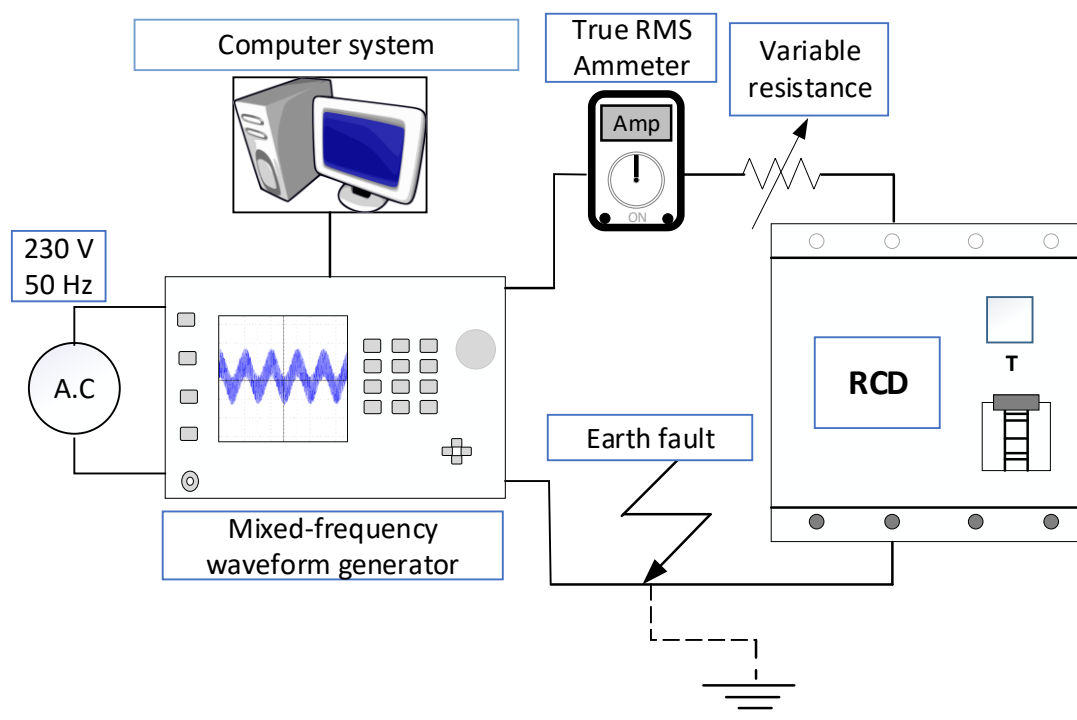

Figure 17: Mixed-frequency test–laboratory stand for RCD testing.

Looking at Figure 17, the test bench contains:

- an AC source of 230 V, 50 Hz that energizes the generator which is responsible to generate mixed-frequency waveforms,
- a computer system, basically a software that maintains the frequency content of each component in the case of mixed-frequency waveform tests,
- an ammeter, to measure the current in the circuit,
- a variable resistance, to limit the current in the circuit.

3.3.4 Test results

The test results have been further subdivided into different categories for a better understanding.

I. Mixed-frequency tests based on two frequency components

- AC type

Figure 18, 19 and 20 explains the recorded results of AC-type RCDs (RCD_AC1, RCD_AC2, RCD_AC3 respectively) when exposed to mixed-frequency waveforms composed of two frequency components as explained in Table 10. It can be clearly observed from these results that as soon as the ratio of second frequency component gets bigger, it effects the tripping phenomena of the RCD. In Figure 18, it can be seen that there was no issue with tripping of RCD_AC5 until the ratio reached up to 25% (50 Hz) and 75% (other frequency component). In Figure 19, RCD_AC2, presents the similar behavior but no tripping could be observed for 10% (50 Hz) and 90 % (1000 and 2000) Hz even for the peak value of applied residual current i.e., $15I_{\Delta n}$ which is 450 mA. In Figure 20, the problem of tripping can be observed even on lower ratio i.e., 50% (50 Hz) and 50 % (1000 and 2000) Hz, when RCD_AC3 couldn't trip at 30 mA ($I_{\Delta n}$). Hence, the problem of tripping appeared even in comparatively favorable conditions as well.

- A-type

Figure 21, 22 and 23 explain the results obtained when three A-type RCDs, RCD_A1, RCD_A3 and RCD_A6, respectively, were tested using the same testing bench as presented in Figure 17. For A-type RCDs, (1000 and 2000) Hz frequency levels have shown the major problem, where no tripping was observed even for the peak value of supplied residual current equal to 15 times the rated current ($15I_{\Delta n}$). RCD_A1 has shown the worst case, where no tripping was observed even with 50 Hz (10%) and 500 Hz (90%), similar result was achieved for higher frequency components, such as for the case 75% of frequency components of (1000 and 2000) Hz and same for 90% of frequency components of (1000 and 2000) Hz. However,



comparatively better behavior was observed for RCD_A6 (Figure 23), where tripping was observed, although at higher residual current level such as $2I_{\Delta n}$ or $5I_{\Delta n}$, but somehow showed positive results as compared to RCD_A1 (Figure 21) and RCD_A3 (Figure 22).

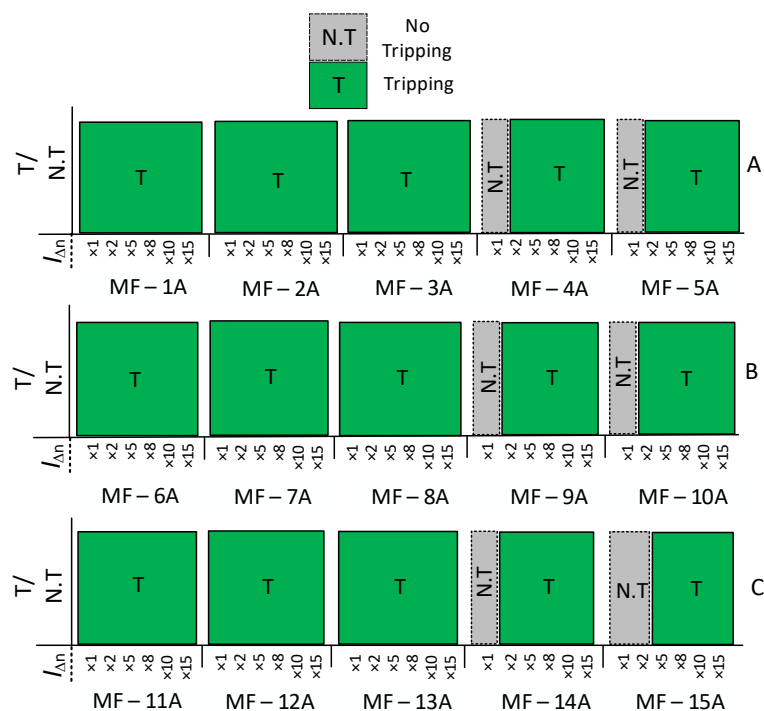

Figure 18: Test results of the AC-type (30 mA) RCD (RCD_AC5) for the mixed-frequency waveforms composed of two components: nominal frequency (50 Hz) and second component with higher frequency level of: A) 500 Hz B) 1000 Hz C) 2000 Hz; MF – mixed-frequency waveform according to Table 10.

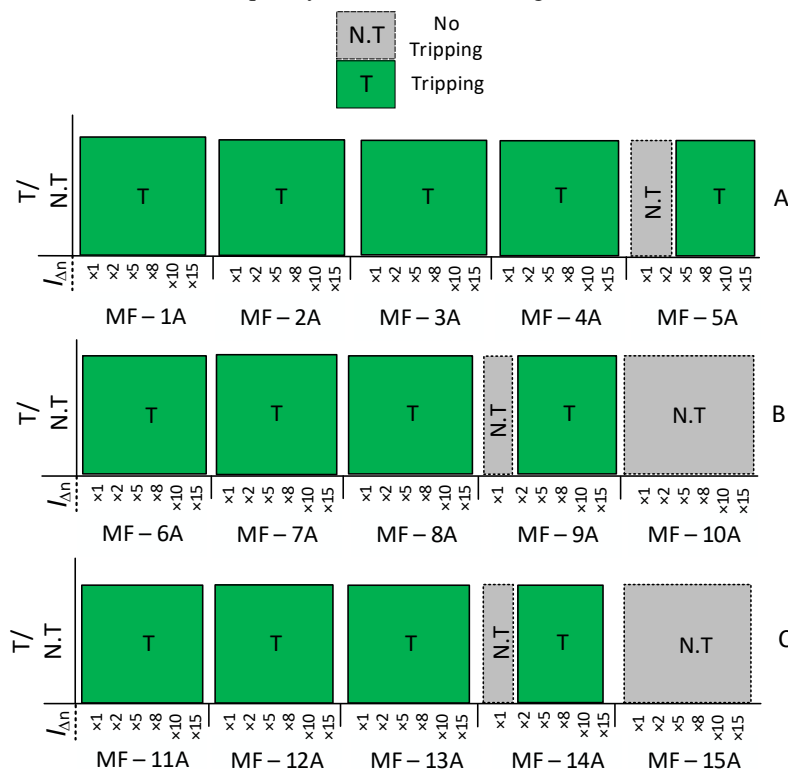

Figure 19: Test results of the AC-type (30 mA) RCD (RCD_AC2) for the mixed-frequency waveforms composed of two components: nominal frequency (50 Hz) and second component with higher frequency level of: A) 500 Hz B) 1000 Hz C) 2000 Hz; MF – mixed-frequency waveform according to Table 10.

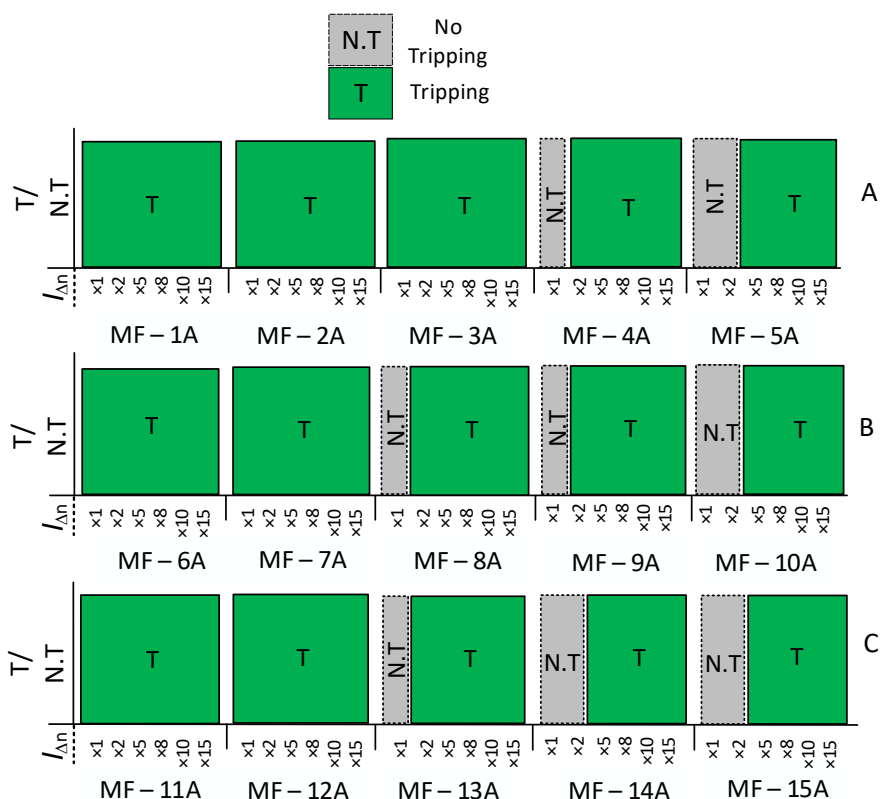

Figure 20: Test results of the AC-type (30 mA) RCD (RCD_AC3) for the mixed-frequency waveforms composed of two components: nominal frequency (50 Hz) and second component with higher frequency level of: A) 500 Hz B) 1000 Hz C) 2000 Hz; MF – mixed-frequency waveform according to Table 10.

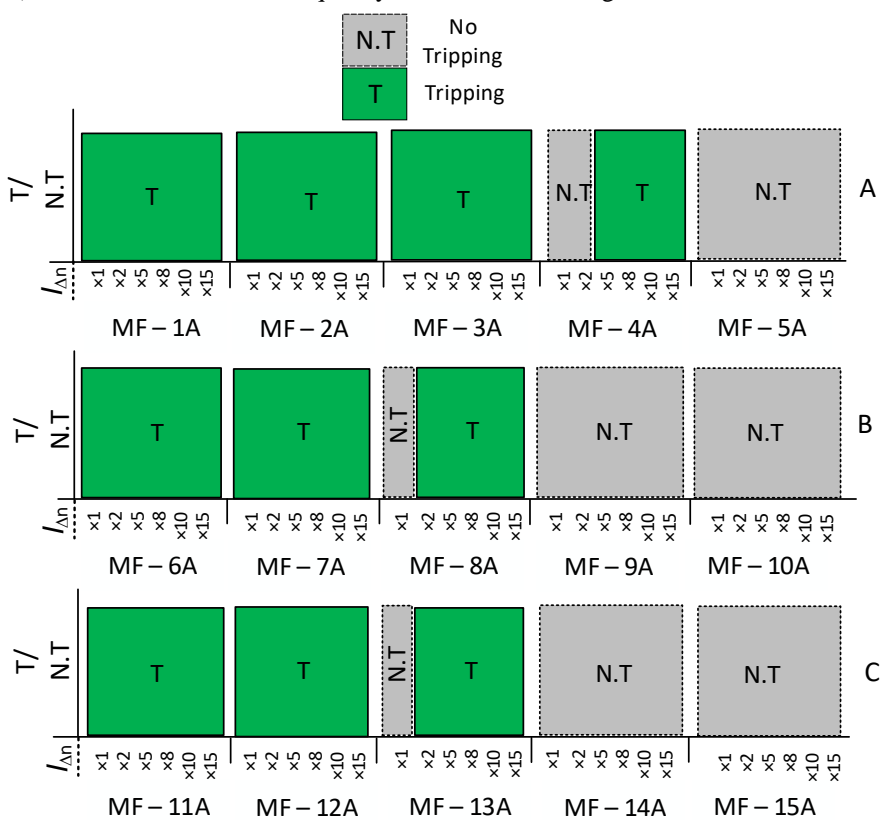

Figure 21: Test results of the A-type (30 mA) RCD (RCD_A1) for the mixed-frequency waveforms composed of two components: nominal frequency (50 Hz) and second component with higher frequency level of: A) 500 Hz B) 1000 Hz C) 2000 Hz; MF – mixed-frequency waveform according to Table 10.

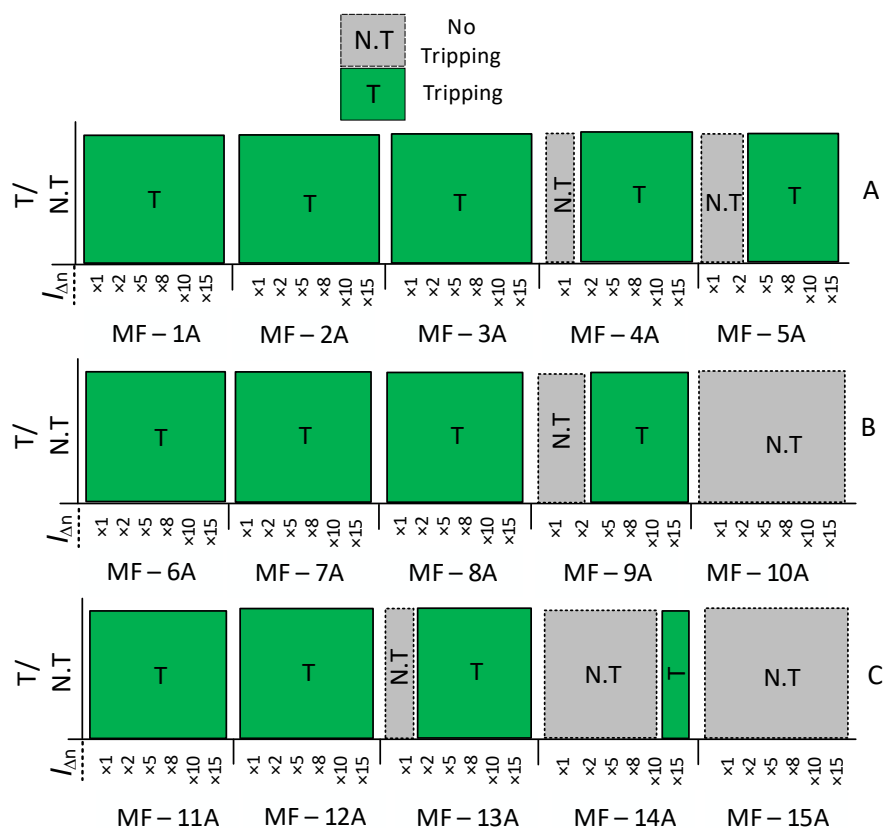

Figure 22: Test results of the A-type (30 mA) RCD (RCD_A3) for the mixed-frequency waveforms composed of two components: nominal frequency (50 Hz) and second component with higher frequency level of: A) 500 Hz B) 1000 Hz C) 2000 Hz; MF – mixed-frequency waveform according to Table 10.

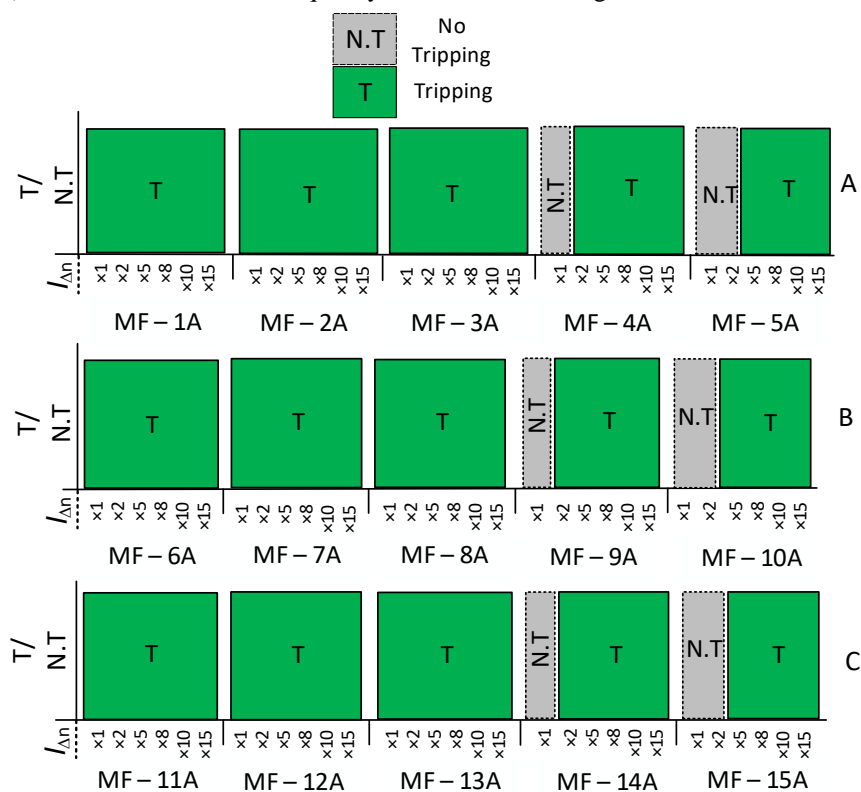

Figure 23: Test results of the A-type (30 mA) RCD (RCD_A6) for the mixed-frequency waveforms composed of two components: nominal frequency (50 Hz) and second component with higher frequency level of: A) 500 Hz B) 1000 Hz C) 2000 Hz; MF – mixed-frequency waveform according to Table 10.

- B-type

Figure 24 and Figure 25 present the B-type RCDs tripping results after providing them with the residual current composed of two mixed-frequency components. Figure 24 presents the test results of RCD_B1 and Figure 25 presents the results attained after the testing of RCD_B2. B-type RCD being the modernized and advanced type of RCD should be good enough in unexpected conditions such as high-frequency or mixed-frequency exposures. For the better verification of the behavior B-type RCDs have been tested both in the presence of auxiliary supply and also in absence of it (without auxiliary supply). For RCD_B1, clear difference can be observed in Figure 24, where in Figure 24 (i), the tripping behavior of the RCD_B1 is ideal until the ratio of both frequencies is 50% (50% nominal frequency component and 50% high-frequency component). As soon as the module of 25% – 75% is approached i.e., 25% nominal frequency and 75% high-frequency component, the problem is clearly visible, no tripping was observed for the rated residual current level $I_{\Delta n}$ (30 mA). The second part of the test (without auxiliary supply) showed quite unsatisfactory results, where for the 10% – 90% module (10% nominal and 90% high-frequency component), all three frequencies 500 Hz, 1000 Hz and 2000 Hz, no tripping was observed until $5I_{\Delta n}$ (150 mA) which is quite unusual for a B-type RCD. For RCD_B2 (Figure 25), behavior was even worse as compared to the RCD_B1, a problem in tripping can be observed in Figure 25 (i) (with auxiliary supply) even at the 50% – 50% module i.e., 50% nominal part and 50% high-frequency part, and it continued to the next frequency modules as well. Similar behavior was observed where no auxiliary was provided in Figure 25 (ii), it is rather surprising because the B-type RCDs are supposed to perform well in the presence of auxiliary supply, here for RCD_B2, no improvement can be seen among both test types i.e., with and without auxiliary supply.

- F-type

Figure 26 and Figure 27 present the results of RCD_F1 and RCD_F2 respectively. Both, aforementioned, F-type RCDs have shown almost similar test results. Both RCDs performed ideally and reacted to the mixed-frequency component until the ratio of 50% – 50%, i.e., 50% nominal frequency content and 50% high-frequency content. However, as soon as the ratio reached 25% – 75% i.e., 25% nominal frequency content and 75% high-frequency content, the RCDs failed to respond to the rated residual current of 30 mA and tripping current went up to $2I_{\Delta n}$ for the aforementioned case and $5I_{\Delta n}$ for the case of 10% – 90% i.e., 10% nominal frequency content and 90% high-frequency content. Both RCDs (RCD_F1 and RCD_F2) in

Figure 26 and Figure 27, respectively, have surprisingly shown the same behavior during the tests.

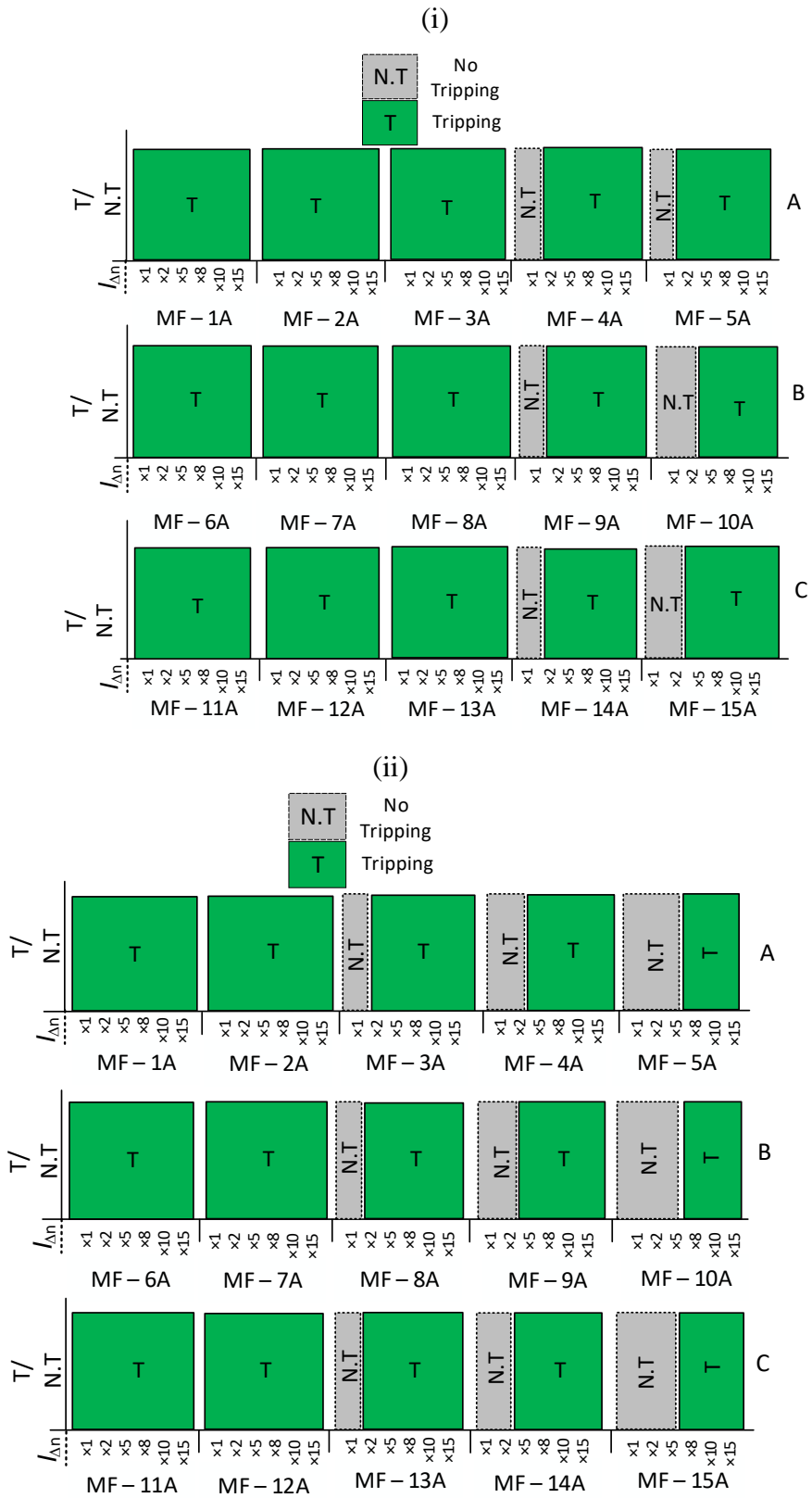

Figure 24: Test results of the B-type (30 mA) RCD (RCD_B1) – (i) with auxiliary supply, (ii) without auxiliary supply – for the mixed-frequency waveforms composed of two components: nominal frequency (50 Hz) and second component with higher frequency level: A) 500 Hz B) 1000 Hz C) 2000 Hz; MF – mixed-frequency waveform according to Table 10.

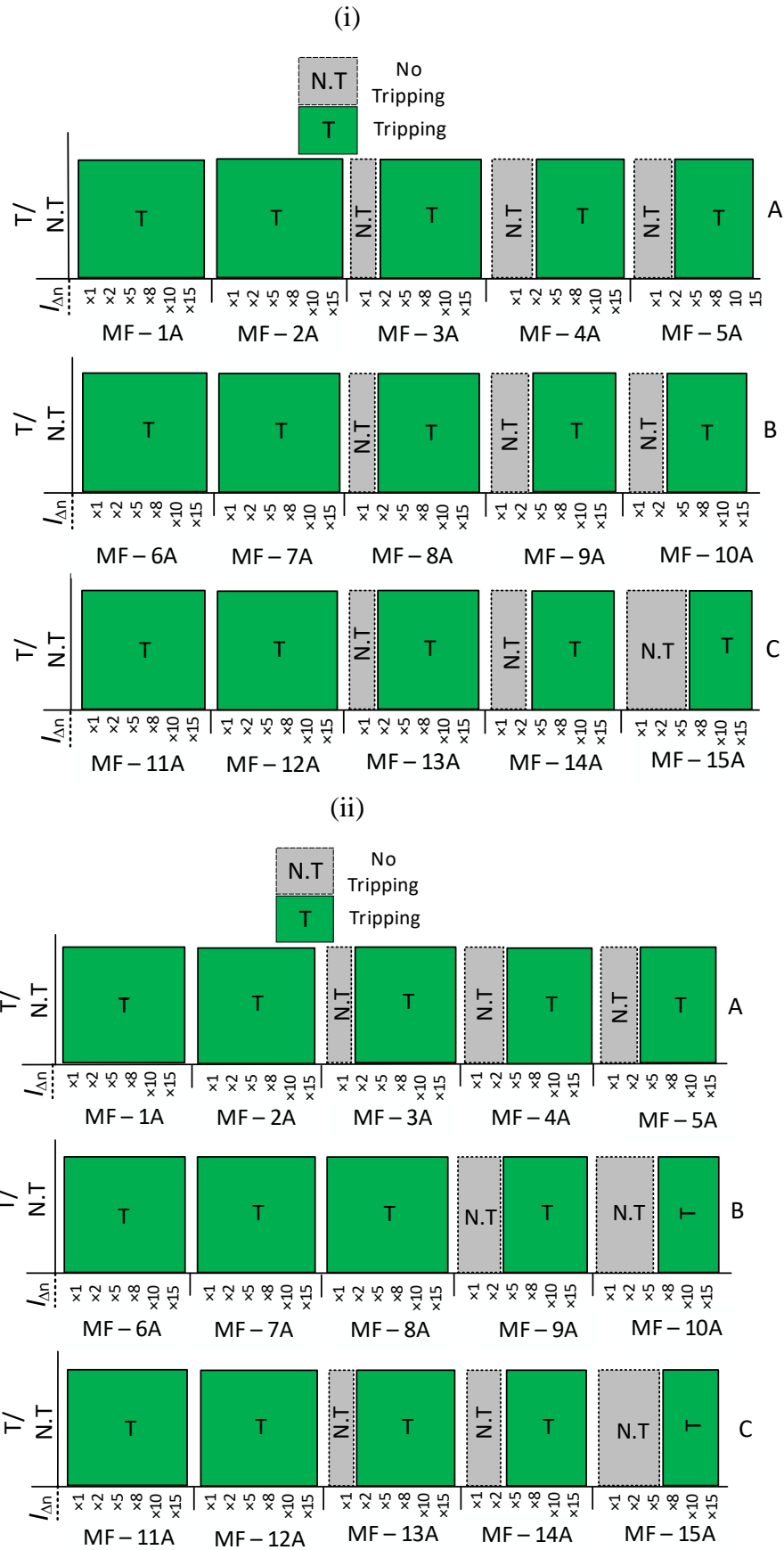

Figure 25: Test results of the B-type (30 mA) RCD (RCD_B2) – (i) with auxiliary supply, (ii) without auxiliary supply – for the mixed-frequency waveforms composed of two components: nominal frequency (50 Hz) and second component with higher frequency level: A) 500 Hz B) 1000 Hz C) 2000 Hz; MF – mixed-frequency waveform according to Table 10.

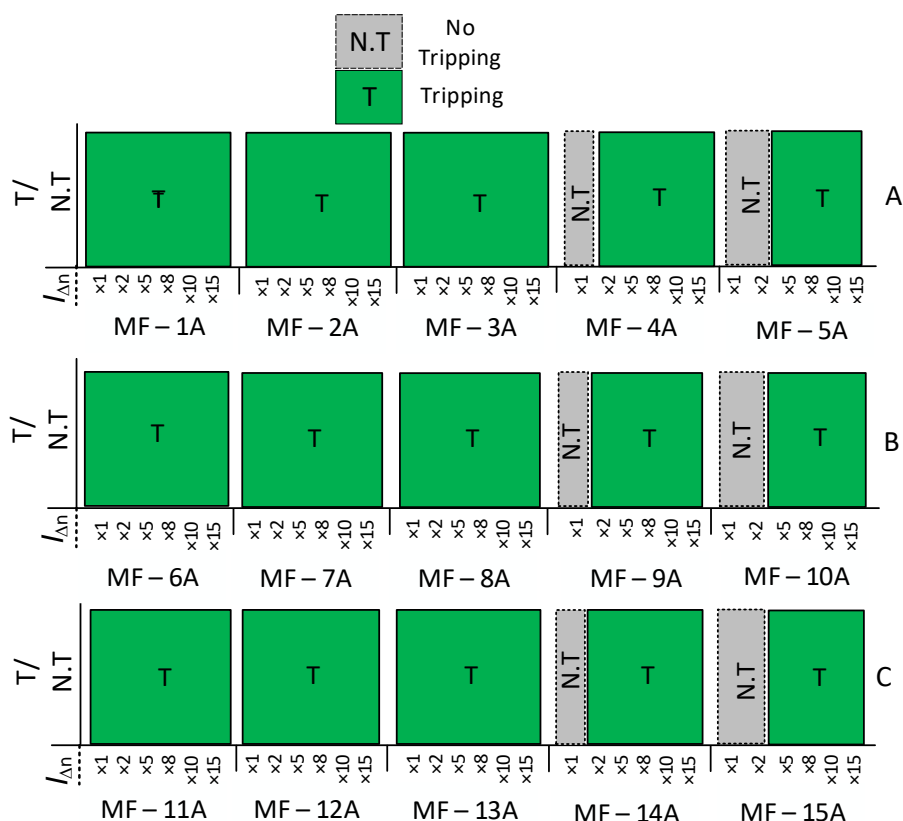

Figure 26: Test results of the F-type (30 mA) RCD (RCD_F1) for the mixed-frequency waveforms composed of two components: nominal frequency (50 Hz) and second component with higher frequency level of: A) 500 Hz B) 1000 Hz C) 2000 Hz; MF – mixed-frequency waveform according to Table 10.

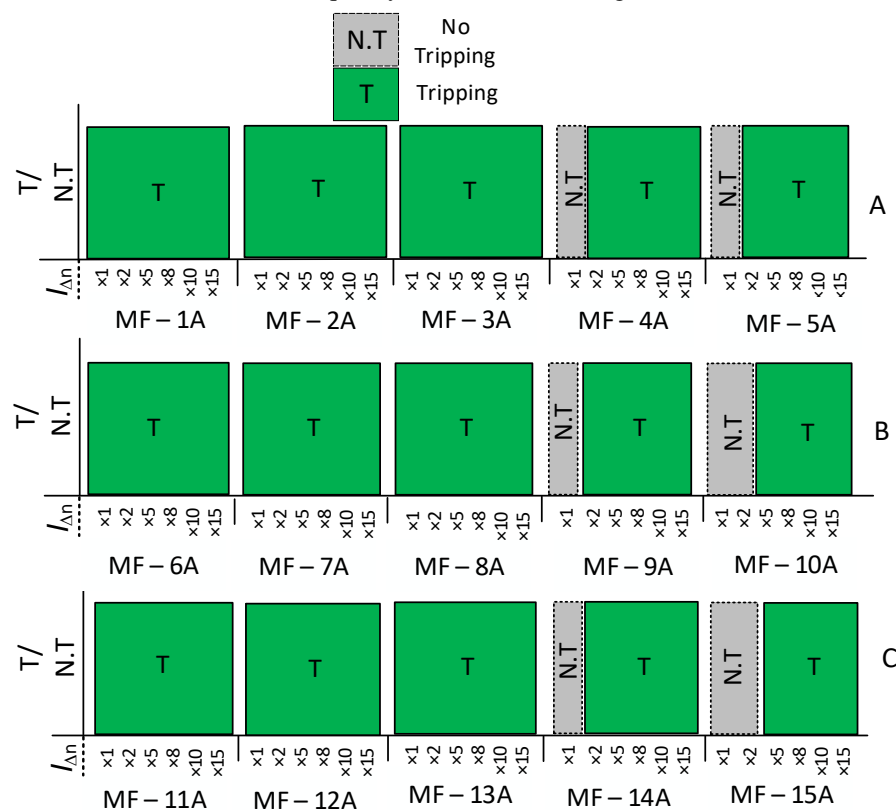

Figure 27: Test results of the F-type (30 mA) RCD (RCD_F2) for the mixed-frequency waveforms composed of two components: nominal frequency (50 Hz) and second component with higher frequency level of: A) 500 Hz B) 1000 Hz C) 2000 Hz; MF – mixed-frequency waveform according to Table 10.

II. Mixed-frequency tests based on three frequency components

- AC type

Figure 28, 29 and 30 explain the recorded results of AC-type RCDs (RCD_AC1, RCD_AC2, RCD_AC3 respectively) when exposed to mixed-frequency waveforms composed of three frequency components, waveforms are explained in Table 11. The mechanism of opting for three frequencies has been explained in section 3.3. It can be clearly observed from these results that as soon as the ratio of higher frequency components reaches a higher level, the behavior of RCD gets negatively affected. Among all the tested frequency levels, the second frequency component (150 Hz) is kept constant and nominal one (50 Hz) and the highest frequency components (500/ 1000/ 2000) Hz is varied sequentially, keeping the overall percentage equal to 100. In Figure 28A, it can be seen that there was no issue in tripping of RCD_AC2 until the ratio reaches up to 5% (50 Hz) and 70% (highest frequency component – 500 Hz). During all three frequency tests, the issue mainly arises when the ratio of higher frequency component gets bigger. The worst result was recorded (Figure 28C), where no tripping could be attained even at many times of rated residual current i.e., $10I_{\Delta n}$ for the case of 5% (50 Hz), 25% (150 Hz) and 70% (2000 Hz). In Figure 29A, B and C, the problem begins even at the ratio of 25% (50 Hz), 25% (150 Hz) and 50% (2000 Hz) where RCD_AC3 didn't trip at $I_{\Delta n}$. In Figure 30, tripping results of RCD_A5 are presented, results are similar to aforementioned cases, no tripping was recorded as soon as the ratio is 25% (50 Hz), 25% (150 Hz) and 50% (1000/ 2000) Hz and also beyond this ratio percentage, RCD_A5 remained intact (untripped) at $I_{\Delta n}$, which is rated residual current.

- A-type

Figure 31, 32 and 33 explain the results obtained after testing of three A-type RCDs, RCD_A1, RCD_A3 and RCD_A6 respectively. These tests were carried out using the same testing bench as presented in Figure 17. For A-type RCDs, the problem starts appearing as soon as the ratio level of 50 Hz – 25%, 150 Hz – 25% and 50% of (500 /1000 /2000) Hz is supplied to the RCD. Figure 31 (RCD_A1) exhibited the worst results among all three tested RCDs. It can be seen in Figure 31B and Figure 31C that for the last ratio i.e., 5% (50 Hz), 25% (150 Hz) and 70% (1000/ 2000) Hz, RCD_A1 didn't trip even at the maximum value of 15 times the $I_{\Delta n}$. Almost same behavior is shown by RCD_A3 in Figure 32. No tripping was observed for the 5% (50 Hz), 25% (150 Hz) and 70% (1000/ 2000) Hz in Figure 32B and Figure 32C. However, RCD_A6 in Figure 33 showed better results in comparison to the other two A-type RCDs. But still, during the tests of highest frequency ratio (for high-frequency component), can be seen

in Figure 33B and Figure 33C, the tripping starts only from a very high rated residual current i.e., $5I_{\Delta n}$ which is equal to 150 mA of residual current.

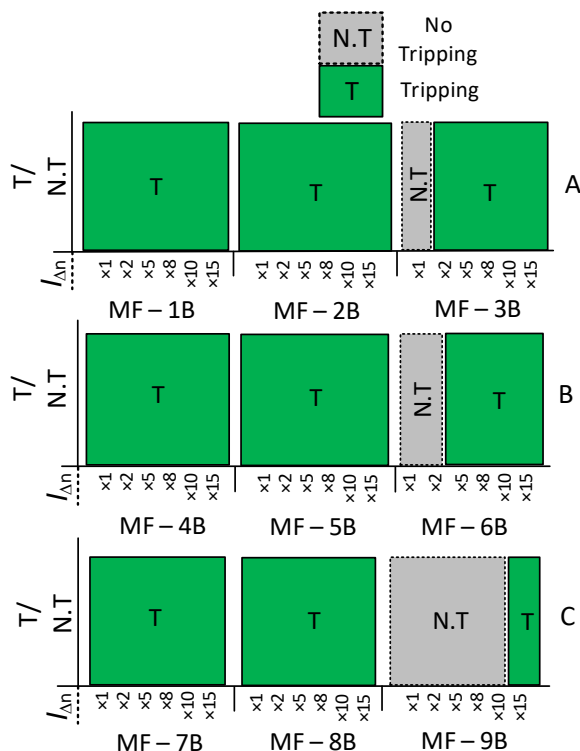

Figure 28: Test results of the AC-type (30 mA) RCD (RCD_AC2) for the following mixed-frequency waveforms composed of three components including 50 Hz, 150 Hz and third higher frequency component of: A) 500 Hz B) 1000 Hz C) 2000 Hz; MF – mixed-frequency waveform according to Table 11.

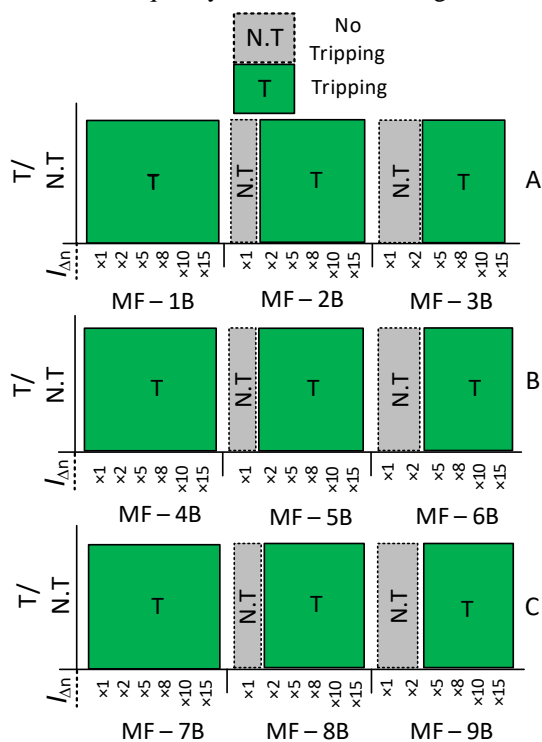

Figure 29: Test results of the AC-type (30 mA) RCD (RCD_AC3) for the following mixed-frequency waveforms composed of three including 50 Hz, 150 Hz and third higher frequency component of: A) 500 Hz B) 1000 Hz C) 2000 Hz; MF – mixed-frequency waveform according to Table 11.

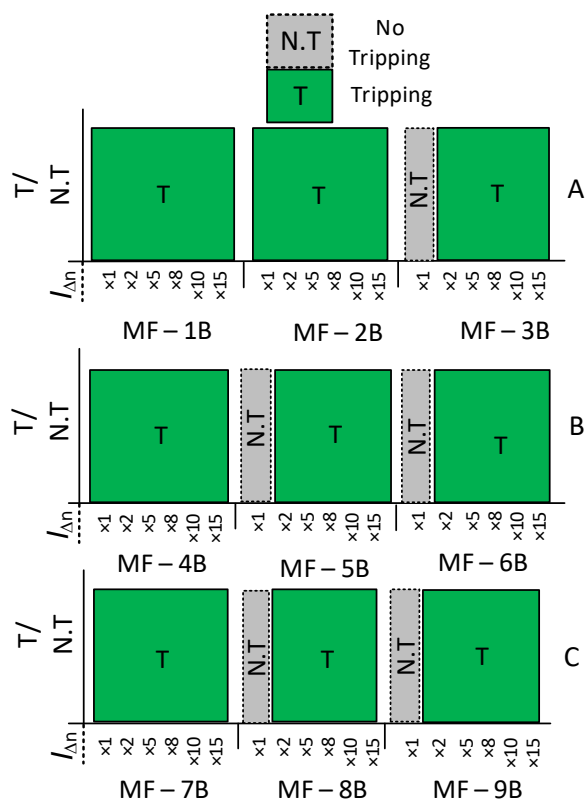

Figure 30: Test results of the AC-type (30 mA) RCD (RCD_AC5) for the following mixed-frequency waveforms composed of three components including 50 Hz, 150 Hz and third higher frequency component of: A) 500 Hz B) 1000 Hz C) 2000 Hz; MF – mixed-frequency waveform according to Table 11.

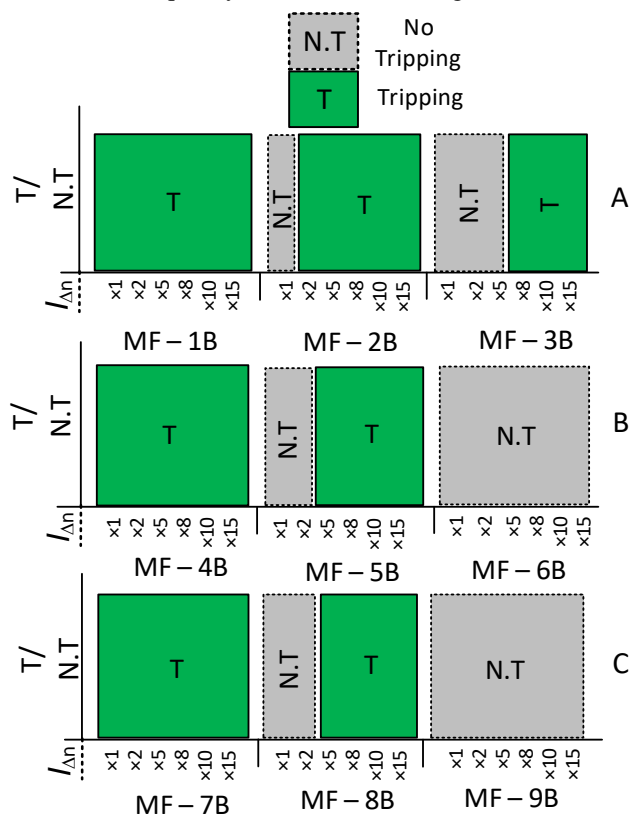

Figure 31: Test results of the A-type (30 mA) RCD (RCD_A1) for the following mixed-frequency waveforms composed of three including 50 Hz, 150 Hz and third higher frequency component of: A) 500 Hz B) 1000 Hz C) 2000 Hz; MF – mixed-frequency waveform according to Table 11.

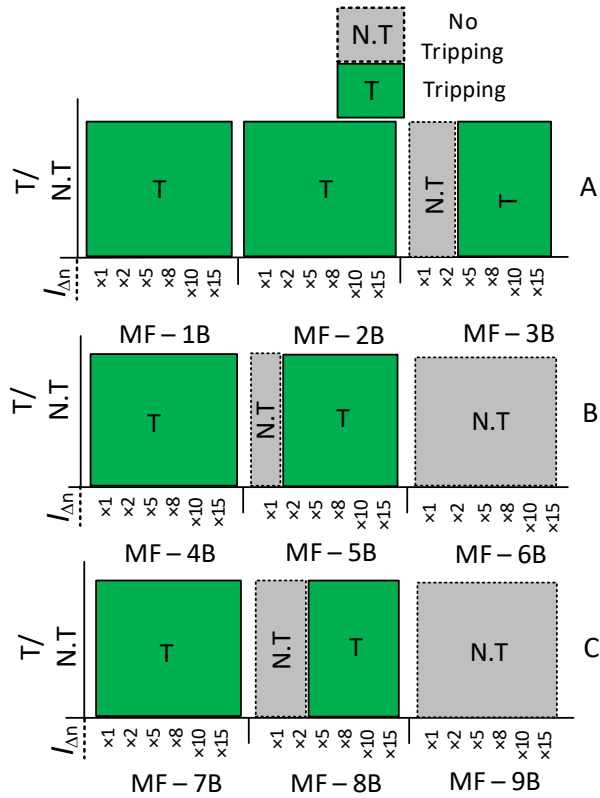

Figure 32: Test results of the A-type (30 mA) RCD (RCD_A3) for the following mixed-frequency waveforms composed of three components including 50 Hz, 150 Hz and third higher frequency component of: A) 500 Hz B) 1000 Hz C) 2000 Hz; MF – mixed-frequency waveform according to Table 11.

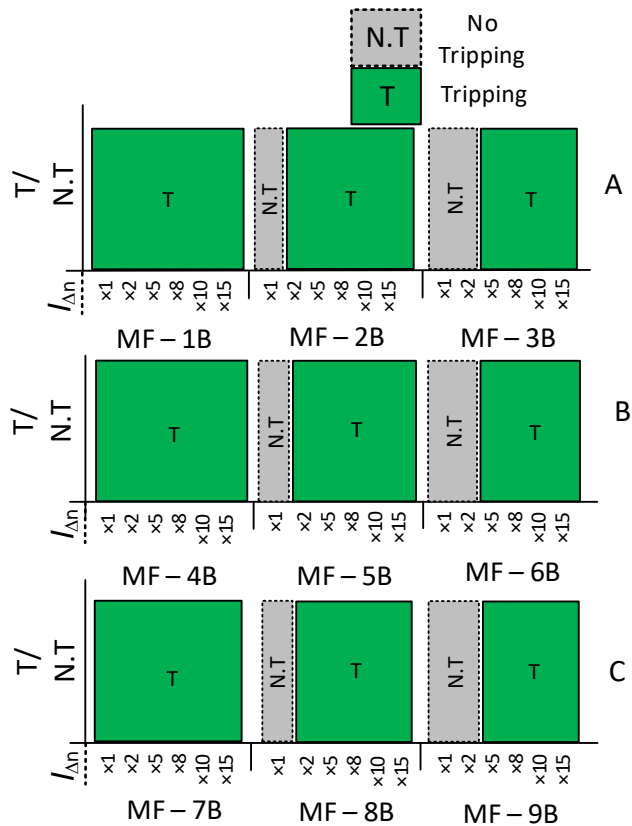

Figure 33: Test results of the A-type (30 mA) RCD (RCD_A6) for the following mixed-frequency waveforms composed of three components including 50 Hz, 150 Hz and third higher frequency component of: A) 500 Hz B) 1000 Hz C) 2000 Hz; MF – mixed-frequency waveform according to Table 11.

- B-type

Figure 34 and Figure 35 present the B-type RCDs tripping results of RCD_B1 and RCD_B2 with auxiliary supply and in the absence of auxiliary voltage as well. Figure 34 presents the test results of RCD_B1 and Figure 35 presents the results attained after the testing of RCD_B2. The case of with and without auxiliary voltage was performed to verify the behavior of B-type RCD in a detailed manner. For RCD_B1, a slight difference was noted in Figure 34, while comparing Figure 34 (i) and Figure 34 (ii), the tripping behavior of the RCD_B1 is ideal until the ratio of 50% (50 Hz), 25% (150 Hz) and 25% (500/ 1000/ 2000) Hz is supplied to the RCD. As soon as the ratio level of 25% (50 Hz), 25% (150 Hz) and 50% (500/ 1000/ 2000) Hz is approached, the problem of the tripping of B-type RCD starts appearing. It is visible in Figure 34 (i) and Figure 34 (ii) that RCD didn't even react to twice the rated value of residual current ($2I_{\Delta n}$) for the ratio of 5% (50 Hz), 25% (150 Hz) and 70% (1000 Hz/ 2000 Hz) and behavior was similar for both cases, with auxiliary supply and without auxiliary supply. The same reaction was noted in the case of RCD_B2 in Figure 35 (i) and Figure 35 (ii), where RCD behaved unsatisfactorily for the ratio levels of 25% (50 Hz), 25% (150 Hz) and 50% (500/ 1000/ 2000) Hz. This was observed in both cases, i.e., with auxiliary supply and without auxiliary supply. Hence, no improvement was recorded even with the proper auxiliary supply in the behavior of both B-type RCDs.

- F-type

Figure 36 and Figure 37 present the results of RCD_F1 and RCD_F2 respectively for the testing under the influence of three frequency components. Similar to previous tests performed for the other types of RCDs, the results of F-type also get problematic once the frequency ratio of 25% (50 Hz), 25% (150 Hz) and 50% (500/ 1000/ 2000) Hz is selected for the testing mechanism. Beyond this point, both RCDs i.e., RCD_F1 and RCD_F2 behaved abnormally and didn't trip at $I_{\Delta n}$ (30 mA). Instead, it exhibited tripping at 60 mA of residual current which is basically the point of $2I_{\Delta n}$ in the explained Figures. However, the worst case is yet to be discussed for the F-type RCD, in Figure 36, RCD-F1 failed to trip even at $2I_{\Delta n}$ and tripping current was raised to $5I_{\Delta n}$ (150 mA) for the frequency ratio of 5% (50 Hz), 25% (150 Hz) and 70% (500/ 1000/ 2000) Hz.



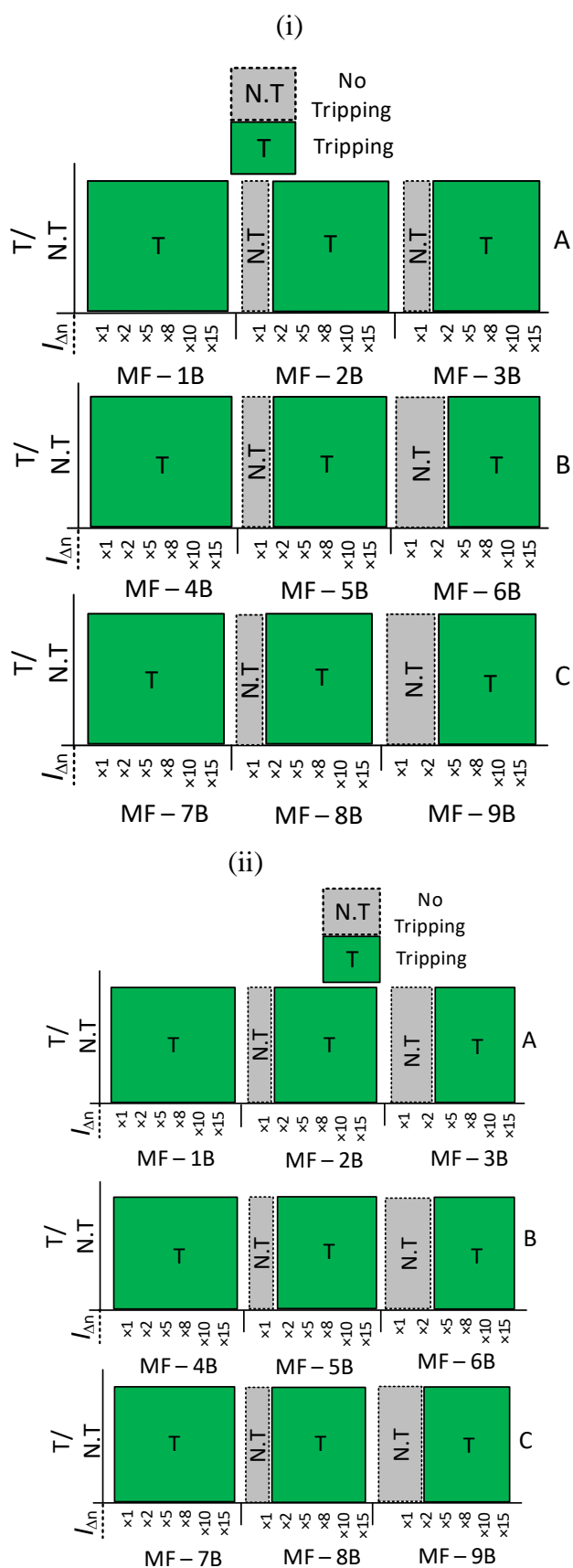

Figure 34: Test results of the B-type (30 mA) RCD (RCD_B1) – (i) with auxiliary supply, (ii) without auxiliary supply – for the following mixed-frequency waveforms composed of three components including 50 Hz, 150 Hz and third higher frequency component of: A) 500 Hz B) 1000 Hz C) 2000 Hz; MF – mixed-frequency waveform according to Table 11.

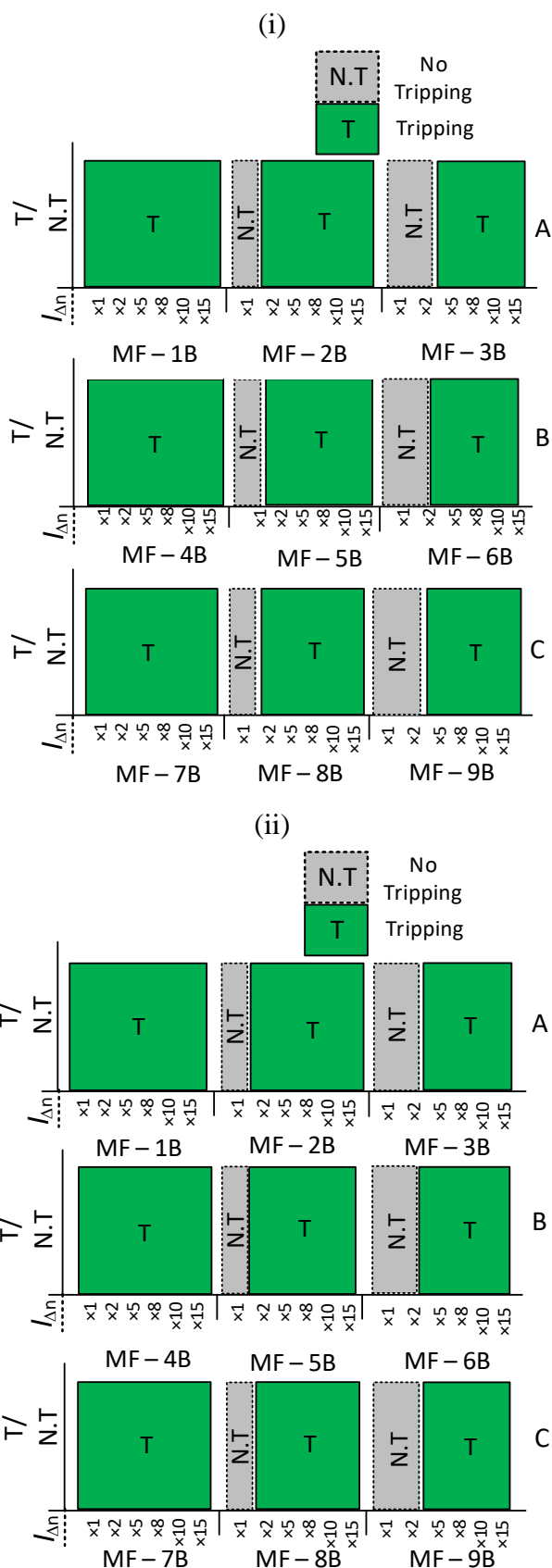

Figure 35: Test results of the B-type (30 mA) RCD (RCD_B2) – (i) with auxiliary supply, (ii) without auxiliary supply – for the following mixed-frequency waveforms composed of three components including 50 Hz, 150 Hz and third higher frequency component of: A) 500 Hz B) 1000 Hz C) 2000 Hz; MF – mixed-frequency waveform according to Table 11.

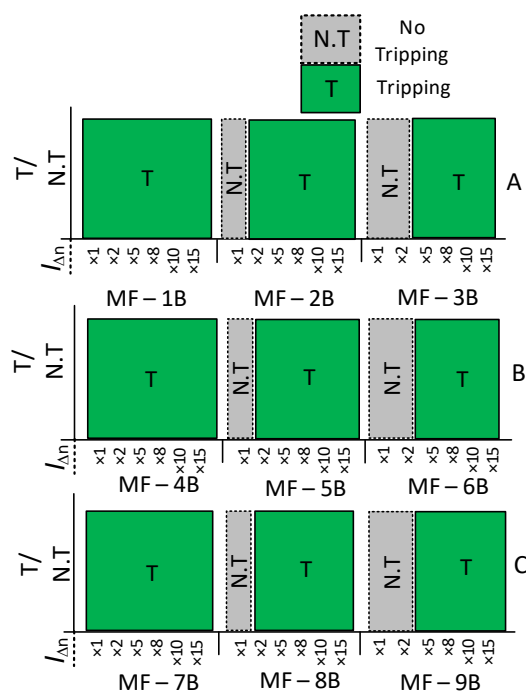

Figure 36: Tripping results of the F-type (30 mA) RCD (RCD_F1) for the following mixed-frequency waveforms composed of three components including 50 Hz, 150 Hz and third higher frequency component of: A) 500 Hz B) 1000 Hz C) 2000 Hz; MF – mixed-frequency waveform according to Table 11.

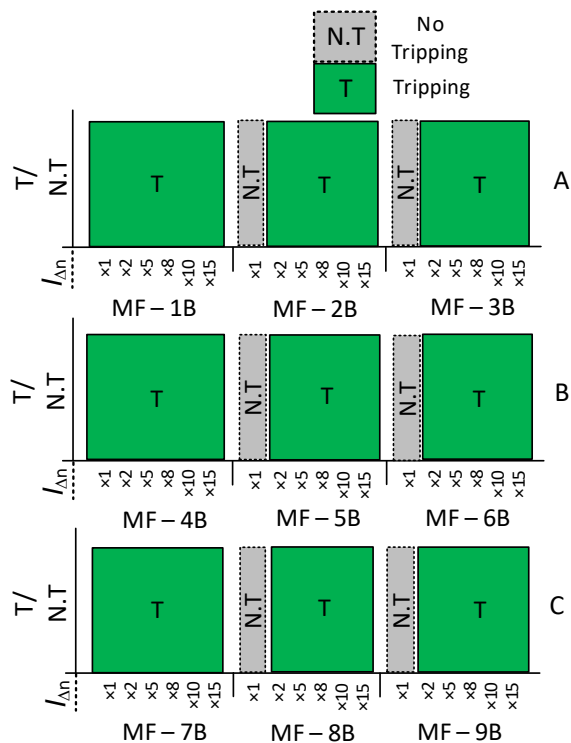

Figure 37: Tripping results of the F-type (30 mA) RCD (RCD_F2) for the following mixed-frequency waveforms composed of three components including 50 Hz, 150 Hz and third higher frequency component of: A) 500 Hz B) 1000 Hz C) 2000 Hz; MF – mixed-frequency waveform according to Table 11.

3.4 Response to suddenly applied DC residual current

The presence of DC residual current is another quite important topic to be discussed and validated. Nowadays, with increasing number of renewables, battery storage energy, electric

vehicles, it is almost inevitable to avoid the presence of DC residual current in the low-voltage power system. The behavior of RCDs have not been verified properly for DC residual currents specifically when DC microgrids are involved. It is quite understandable and explained well in earlier chapters that in the latest design of the RCD available on the market, the current transformer is not quite sensitive to the DC (non-pulsating) waveforms. It is crucial to synchronize the RCD to the anticipated waveform of the expected residual current as the earth fault current is detected using an iron core current transformer of the RCD. A direct current with very little pulsation, like that from a bridge diode rectifier or a battery-based DC power source, i.e., a battery energy storage unit, is the hardest to detect by the installed and available RCDs because the iron core's magnetic induction varies less than it does for a sinusoidal residual current. In that scenario, the secondary current transformer cannot be relied upon to provide the proper voltage required to initiate the tripping of the RCD. The behavior of RCDs has been verified with the testing of DC residual currents and results are exhibited in this dissertation. In the test, RCDs of all types have been verified by exposing them to pure DC residual current (suddenly applied), the values/steps of the residual current are as follows: (15, 20, 30, 60, 90, 150, 300) mA. Each value has been verified multiple times in total three attempts with a few seconds gap to ensure the correct verification of waveforms. However, B-type RCDs are tested differently in order to ensure the role of auxiliary supply in their tripping nature.

3.4.1 List of tested RCDs.

Selected RCDs and their allocated codes for tests of DC residual current (suddenly applied) are presented in Table 13.

Table 13: List of tested RCDs for (suddenly applied) DC residual current.

Type of RCD	Manufacturer	Code used in dissertation
AC-type	Mr_2	RCD_AC2
AC-type	Mr_4	RCD_AC5
A-type	Mr_3	RCD_A1
A-type	Mr_1	RCD_A5
B-type	Mr_6	RCD_B1
B-type	Mr_4	RCD_B2
F-type	Mr_7	RCD_F1
F-type	Mr_4	RCD_F2

3.4.2 Laboratory test bench

Figure 38 explains the test bench used to perform DC residual current tests contains:

- DC generator to get the pure DC residual current,
- an ammeter that supports DC calculations to measure the current in the circuit,
- a variable resistance, to control the current in the circuit,
- for only B-type RCD – auxiliary voltage supply i.e., AC, DC or without auxiliary – tested with L-L connections and L-N connections as well,
- RCD – meant to be tested.

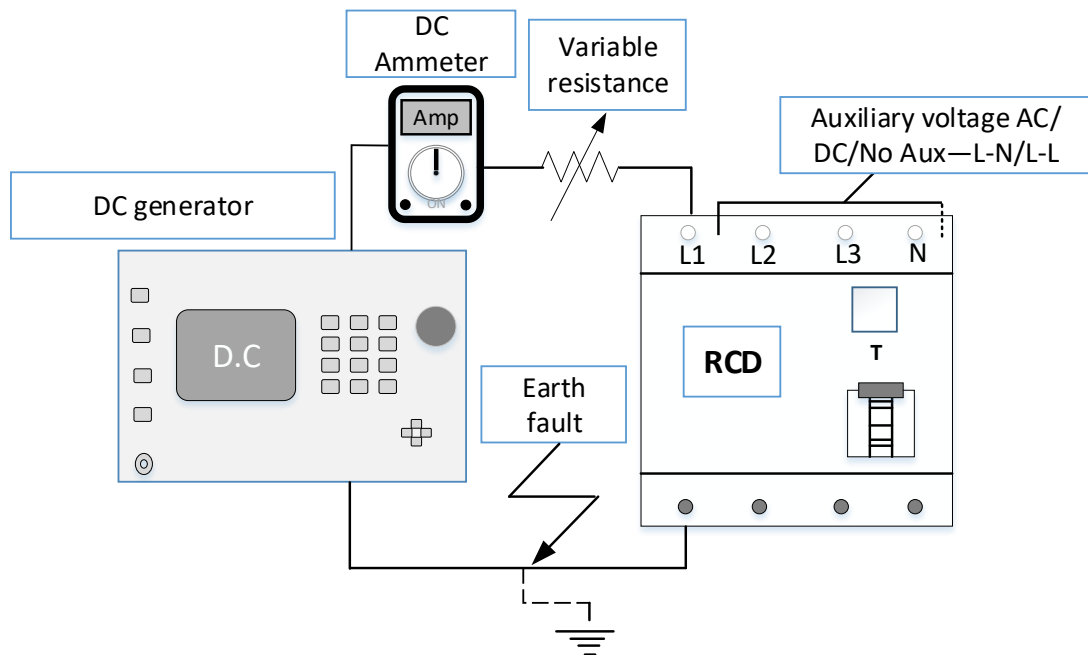

Figure 38: Suddenly applied pure DC residual current test – laboratory stand for RCD testing.

3.4.3 Test results

- AC type

Figure 39A and Figure 39B explain the results obtained after testing the AC type RCDs (RCD_AC2 and RCD_AC5) against suddenly applied pure DC residual current. The annotation in the aforementioned Figures explains the context of ‘tripping’ and ‘no tripping’ which are represented in the Figure 39 as different colors. The results of AC-type RCDs were quite discouraging and unfavorable. RCDs were tested with both (+) and (-) polarities of DC residual current. It is visible in Figure 39 that both RCDs failed to produce required results regardless of the polarity supplied during the tests. However, in some cases, such as in the cases of 150 mA and 300 mA, RCD_AC2 tripped just for first attempt positively. Again, the current levels of 150 mA and 300 mA are equal to five times the rated residual current ($5I_{\Delta n}$) and ten times ($10I_{\Delta n}$), respectively. For the case of RCD_AC5 (Figure 39B), results were again unfavorable and it only managed to show tripping on the negative polarity of 300 mA ($10I_{\Delta n}$), and it only happened for the second (II) and third (III) attempts.

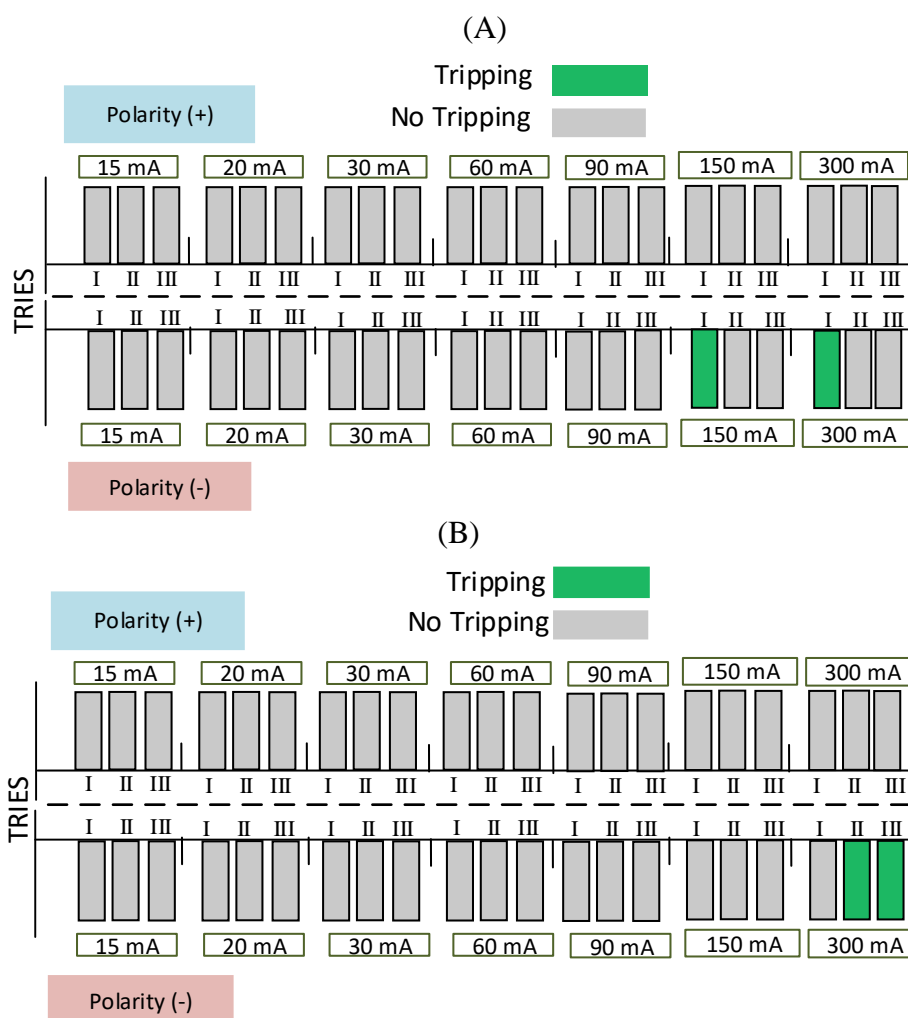

Figure 39: Tripping results of the AC-type (30 mA) RCDs for the pure DC residual current (sudden applied): (A) RCD_AC2, (B) RCD_AC5.

- A-type

Figure 40A and Figure 40B present the tripping results of RCD_A1 and RCD_A6, respectively, after exposing both aforementioned RCDs to the pure DC residual current (suddenly applied). The results obtained after the testing of A-type RCDs are slightly better in comparison to the AC-type as explained in Figure 38. For the RCD_A1 (Figure 40A), no tripping was recorded at the rated residual current value (30 mA). Polarity of the DC residual current supplied to the RCD didn't have any influence on the tripping of both A-type RCDs. The first tripping for RCD_A1 can be observed at 60 mA of residual current for both negative and positive polarities. However, the worst behavior among A-type was observed for RCD_A6 in Figure 40B, where RCD_A6 didn't react to any current until 90 mA, for both polarities and even three attempts for each value of DC residual current. RCD_A6 tripping at 150 mA of DC residual current and above. The results of A-type RCDs (Figure 40) are somehow better than those of AC-type (Figure 39) but still not good enough to be relied upon.

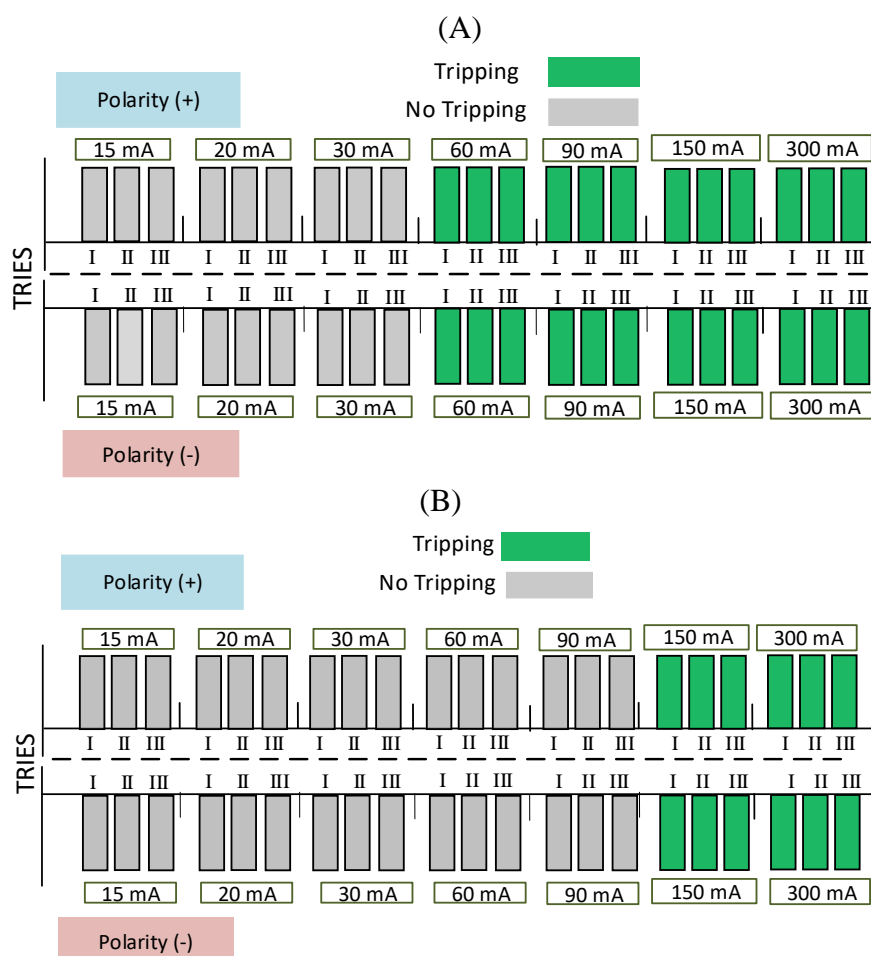

Figure 40: Tripping results of the A-type (30 mA) RCD for the pure DC residual current (sudden applied): (A) RCD_A1, (B) RCD_A6.

- B-type

For B-type RCDs, as mentioned before in this dissertation that it is obligatory to supply B-type RCDs with an auxiliary supply. According to manufacturer, it is necessary to have auxiliary supply in order to detect DC residual current and the auxiliary supply must be connected at least between two poles, either L-N or L-L. The tests explained in Figure 41 have three different scenarios:

1. With AC auxiliary (230 V), when the RCD is installed along with a rectifier, only this way, it is possible to get AC auxiliary for an RCD supposed to protect DC circuits,
2. With DC auxiliary (230 V), when RCD is installed with DC circuits where only DC is available as an auxiliary supply,
3. No auxiliary, the scenario when the auxiliary supply has been cut-off due to any defect.

The tests performed according to aforementioned criteria have been presented in Figure 41A and Figure 41B of two B-type RCDs (RCD_B1 and RCD_B2) respectively. RCD_B1 (Figure 41A) started reacting towards the applied DC residual current at 30 mA, only in the case of AC auxiliary supply of 230 V. However, for DC auxiliary supply, the behavior of RCD_B1 was different. It tripped at 30 mA of residual current value but only where the connections of

auxiliary supply were from L-N, for L-L connection, RCD_B1 didn't trip even for 60 mA of DC residual current. Although, from 90 mA and beyond, RCD_B1 tripped normally. Similar reaction of RCD_B1 was noted for 'no auxiliary supply' scenario. The reaction of RCD_B2, was different rather positive just when there was an auxiliary supply (both AC and DC). It tripped from the 30 mA of residual current and behaved positively after that. However, in the absence of auxiliary supply, RCD_B2 behaved worst and not a single tripping could be recorded even at the highest provided DC residual current of 300 mA. Hence, it is evident that auxiliary supply plays an important role in detecting the DC residual current and the auxiliary supply should be supplied while including the neutral conductor of the RCD.

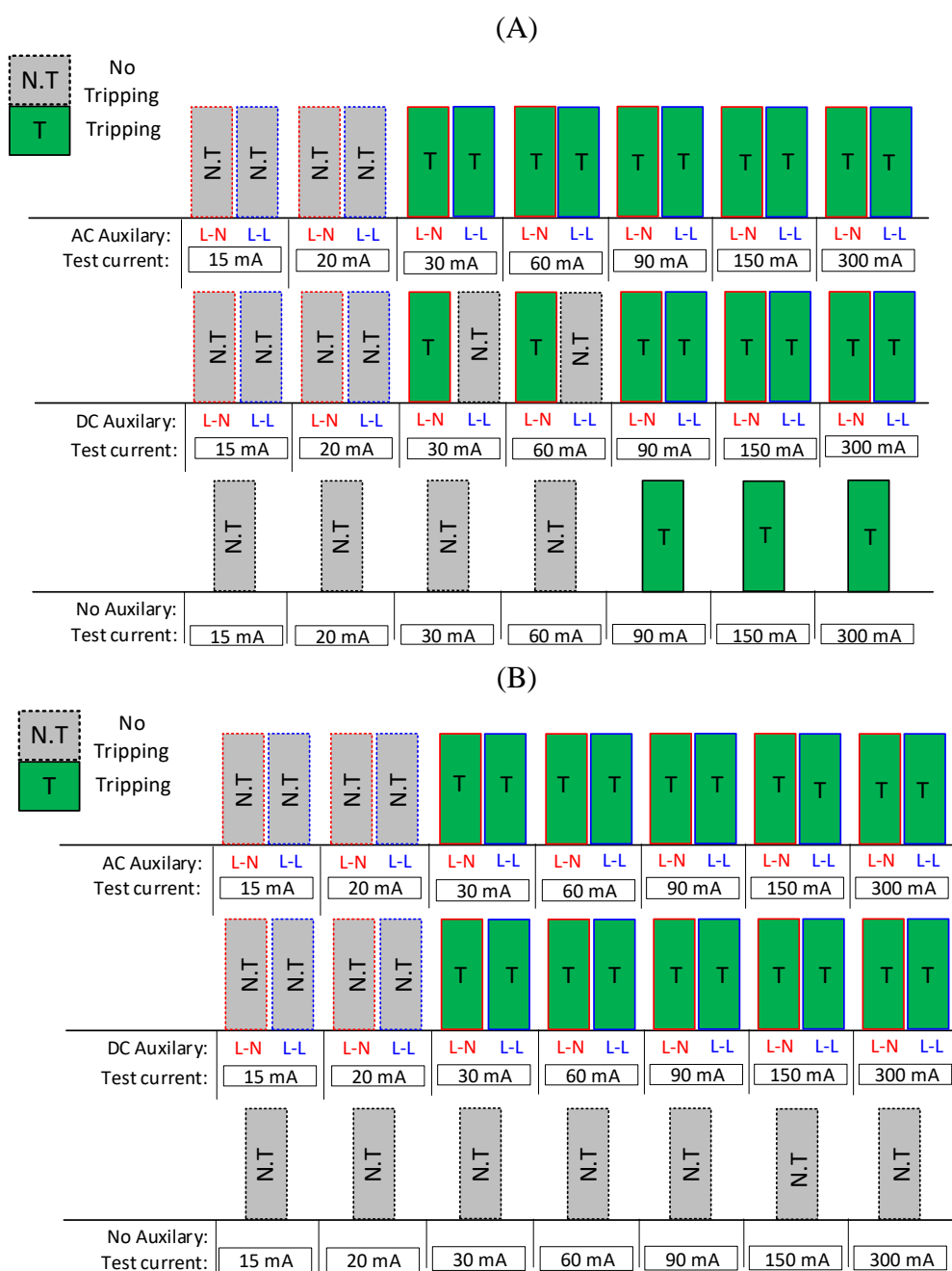

Figure 41: Tripping results of the B-type (30 mA) RCD for the pure DC residual current (sudden applied): (A) RCD_B1, (B) RCD_B2.

- F-type

The results of F-type RCDs, RCD_F1 and RCD_F2, are presented in Figure 42A and Figure 42B, respectively. The obtained results were quite unexpected that none of the two tested RCDs of F-type were able to react/trip on the supplied DC residual current. Although, F-type RCDs are made with one of the latest techniques and circuit designs, which are available for low-voltage power system protection. Still, no tripping could be initiated for any value of DC residual current, even as high as 300 mA and three attempts for each value of current. Even polarity had no positive influence on the tripping of the F-type RCDs.

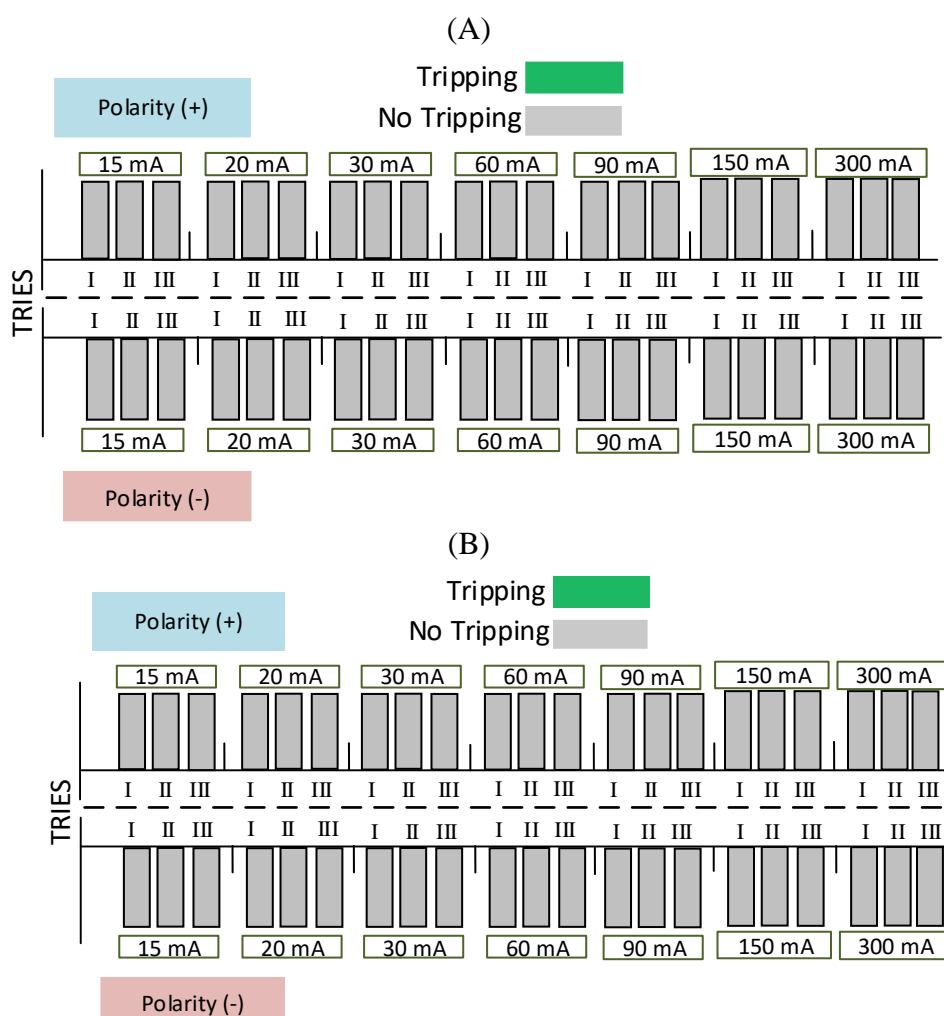

Figure 42: Tripping results of the F-type (30 mA) RCD for the pure DC residual current (sudden applied): (A) RCD_F1, (B) RCD_F2.

3.5 Response to slowly rising residual current— from DC (0 Hz) to 50 kHz

In these tests, the selected RCDs were supplied with a residual current via a mixed-frequency generator and it was gradually increased to record the exact value of tripping point. The supplied residual current (slowly rising) was started from 1 mA and eventually raised to 1 A. That means, each RCD was tested for the residual current value over 30 times bigger than the rated one. These tests have been divided into two subcategories:

- First category– starting from the 0 Hz (DC) and going step-wise to the frequency level of 45 Hz, which a near to nominal (50 Hz). Selected frequency levels were: (0 – 1 – 2 – 3 – 4 – 5 – 10 – 15 – 20 – 25 – 30 – 40 – 45) Hz.
- Second category– starting from 50 Hz to high-frequency levels. Selected frequency levels were: (50 – 100 – 250 – 500 – 750 – 1000 – 2000 – 5000 – 7500 – 10000 – 15000 – 20000 – 25000 – 30000 – 40000 – 50000) Hz.

Existing literature lacks sufficient attention to the responsiveness of residual current devices and their behavioral verification via different tests for tripping under direct currents in installations that use direct current sources. However, the presence of DC circuits is becoming inevitable because of the increased installation of photovoltaic (PV) and electric vehicle (EV) installations. The study done in [85] highlights notable theoretical concerns with the functioning of RCDs in PV systems and covers the scope of DC earth faults. The waveform shapes can be both unidirectional and irregular, which might be a challenge for less advanced RCDs, specifically A-type RCDs, commonly employed in different low-voltage installations. The study [86] also addresses the problem of insufficient sensitivity of A-type RCDs in DC residual currents. If the anticipated DC component value exceeds 6 mA, majority of existing RCDs on the market would fail to provide an ensured electric shock protection. In such cases, either a dedicated RCD should be installed, which is designed to encounter DC residual currents or the standards and practices of existing design must be changed to provide reliable protection in low-voltage power system. High-frequency levels are again being tested in this chapter (similar to previous one) with one change, i.e., slowly increasing residual current instead of suddenly applied. This is performed in order to test the behavior and tripping threshold of the RCDs on a broader level.

3.5.1 List of tested RCDs

Following RCDs have been selected for the tests:

Table 14: List of selected RCDs for slowly rising residual current tests.

Type of RCD	Manufacturer	Code used in dissertation
AC-type	Mr_1	RCD_AC1
AC-type	Mr_3	RCD_AC4
A-type	Mr_3	RCD_A1
A-type	Mr_2	RCD_A2
B-type	Mr_6	RCD_B1
B-type	Mr_4	RCD_B2
F-type	Mr_7	RCD_F1
F-type	Mr_4	RCD_F2

3.5.2 Test bench

Figure 43 explains the test bench used to perform slowly rising residual current tests contains:

- a generator to get the residual current starting from DC (0 Hz) to 50 kHz,
- an ammeter that supports both AC and DC calculations to measure the current in the circuit,
- a variable resistance, to limit the current in the circuit in order to gradually raise the residual current,
- a computer, to attain the high-frequency waveforms via dedicated software,
- an oscilloscope, in order to measure the residual operating current – verification of the values attained via ammeter,
- RCD, meant to be tested.

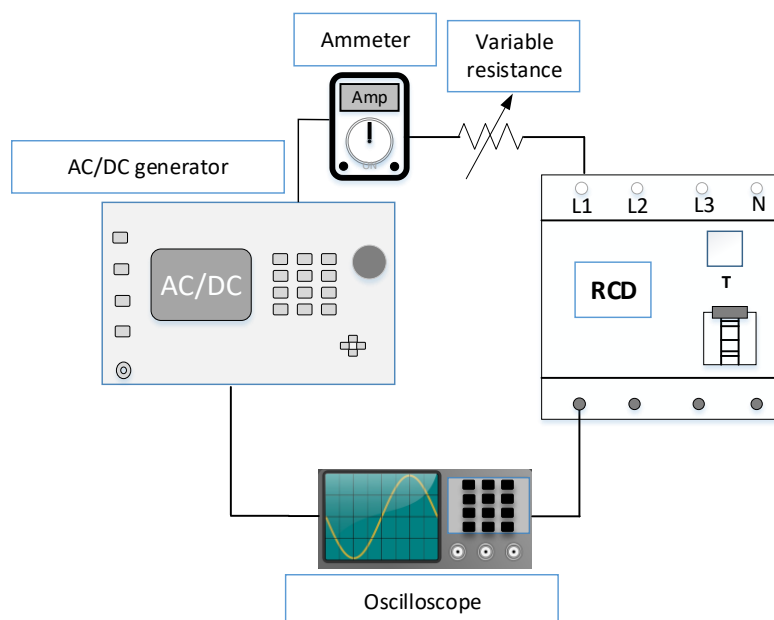

Figure 43: Slowly rising residual current test–laboratory stand for RCD testing.

3.5.3 Test results

- AC type

Figure 44 and Figure 45 explain and present the test results obtained after exposing the 30 mA AC-type RCD, RCD_AC1 and RCD_AC4 respectively. As explained before, the tests have been subdivided into two categories, hence into two Figures here as Figure 44A and Figure 45A explain the test results from DC to 45 Hz and Figure 44B and Figure 45B present the results obtained from 50 Hz to 50 kHz. For the initial test category, both RCDs, RCD_AC1 and RCD_AC4 (Figure 44A and Figure 45A), didn't perform well especially when they were exposed to DC residual current (0 Hz) and also to the low-frequency levels. The tripping current was gradually increased to 1000 mA for DC (0 Hz) case, but no reaction was observed. Even at 1 Hz (Figure 44A and Figure 45A) the tripping current was 3 to 5 times higher than

the rated one. Moreover, for the former part of test, Figure 44B and Figure 45B, the behavior of both RCDs (RCD_AC1 and RCD_AC4) was only suitable until 250 Hz frequency level. As soon as 500 Hz is selected, RCD_AC1 at least reacted to the residual current but after crossing the permissible range of $(0.5-1.0)I_{\Delta n}$. However, RCD_AC4 in Figure 45B showed no tripping at all even at a very high residual current of 1000 mA (1 A). The behavior of both RCDs proves that AC-type RCDs can't be relied upon for the safety of low-voltage power system from an electric shock.

- A-type

Figure 46 and Figure 47 present the results of A-type RCDs, RCD_A1 and RCD_A3, respectively. Similar to previously mentioned AC-type tests, these test results are also presented in two parts i.e., Figure 46A and Figure 47A explain the results starting from DC to 45 Hz and Figure 46B and Figure 47B depict the test results of frequency levels starting from 50 Hz to 50 kHz. Yet again, even A-type RCDs didn't perform satisfactorily in these tests and no tripping could be attained for both RCDs for DC residual current (Figure 46A and Figure 47A). Both RCDs showed tripping at very low-frequency levels such as 1 Hz, 2 Hz, 3 Hz and 4 Hz but the tripping level was achieved outside of permissible range of residual current. For former part of test, Figure 46B and Figure 47B, as soon as the frequency level of 500 Hz is selected, either the tripping current was many times higher than the nominal one or the RCD didn't trip at all even at 1000 mA of residual current. Hence, even A-type RCDs didn't perform well in the aforementioned testing mechanism, which is the most commonly used type of RCD.

(A)

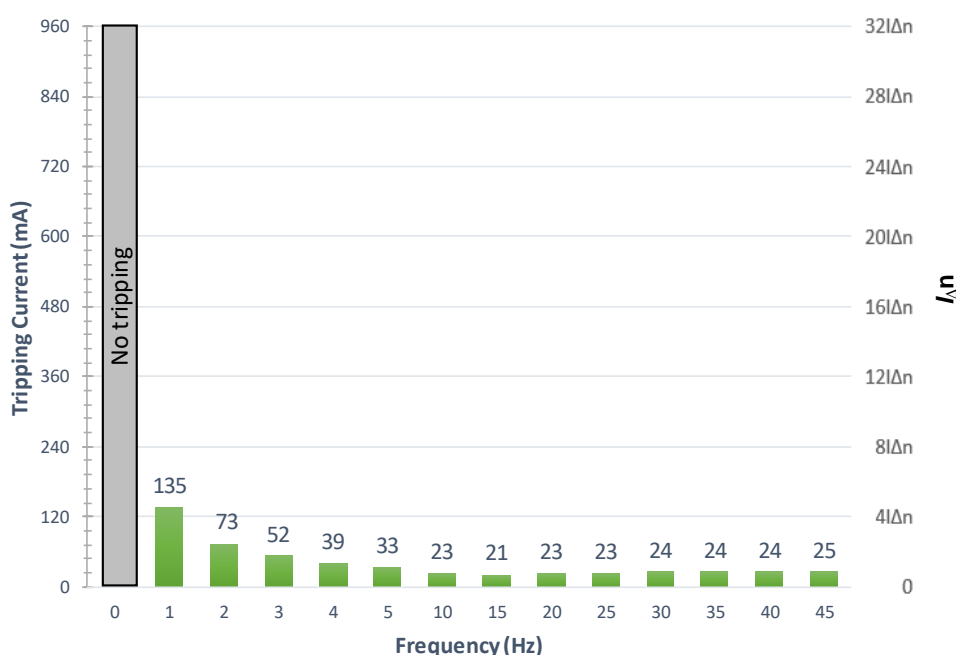

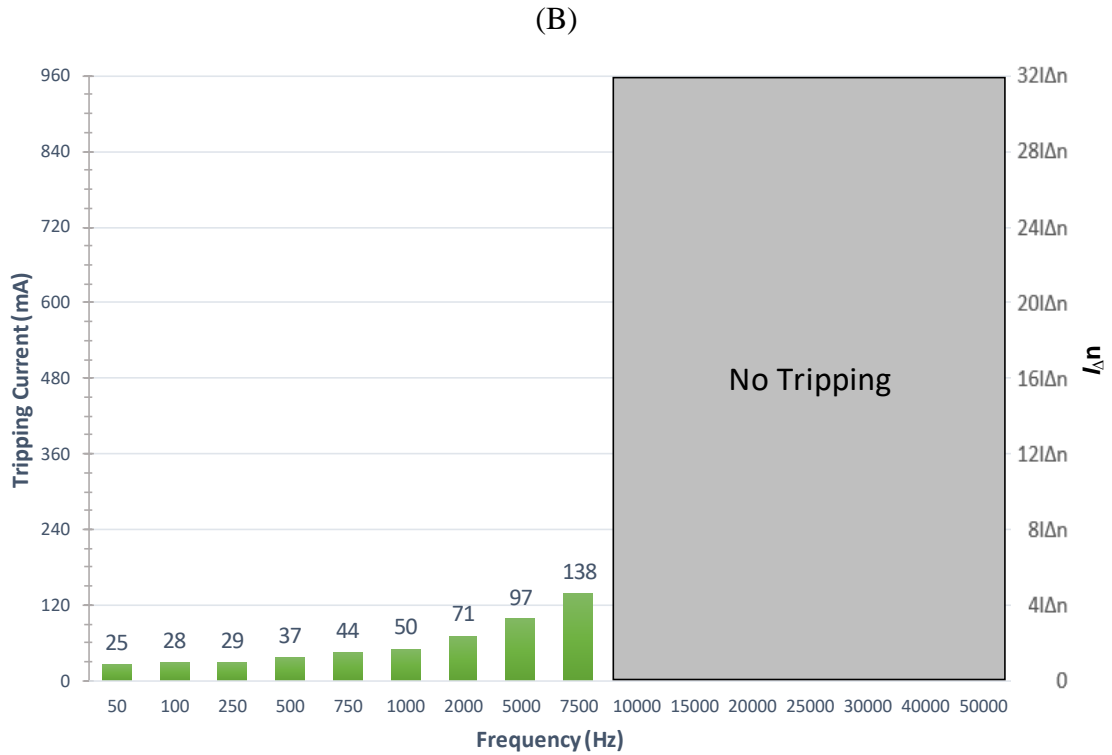
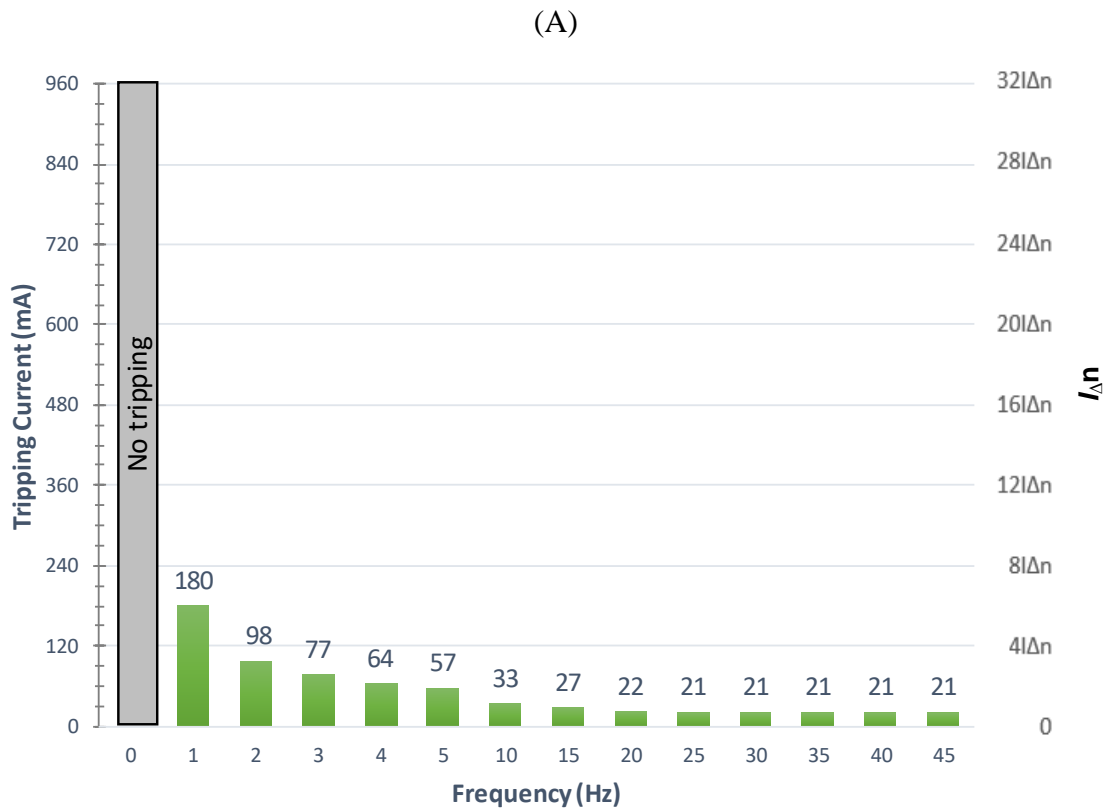

Figure 44: Tripping results of AC-type (30 mA) RCD (RCD_AC1) for the following slowly rising residual currents: (A) test results from DC (0 Hz) to AC 45 Hz, (B) test results from 50 Hz to 50000 Hz.



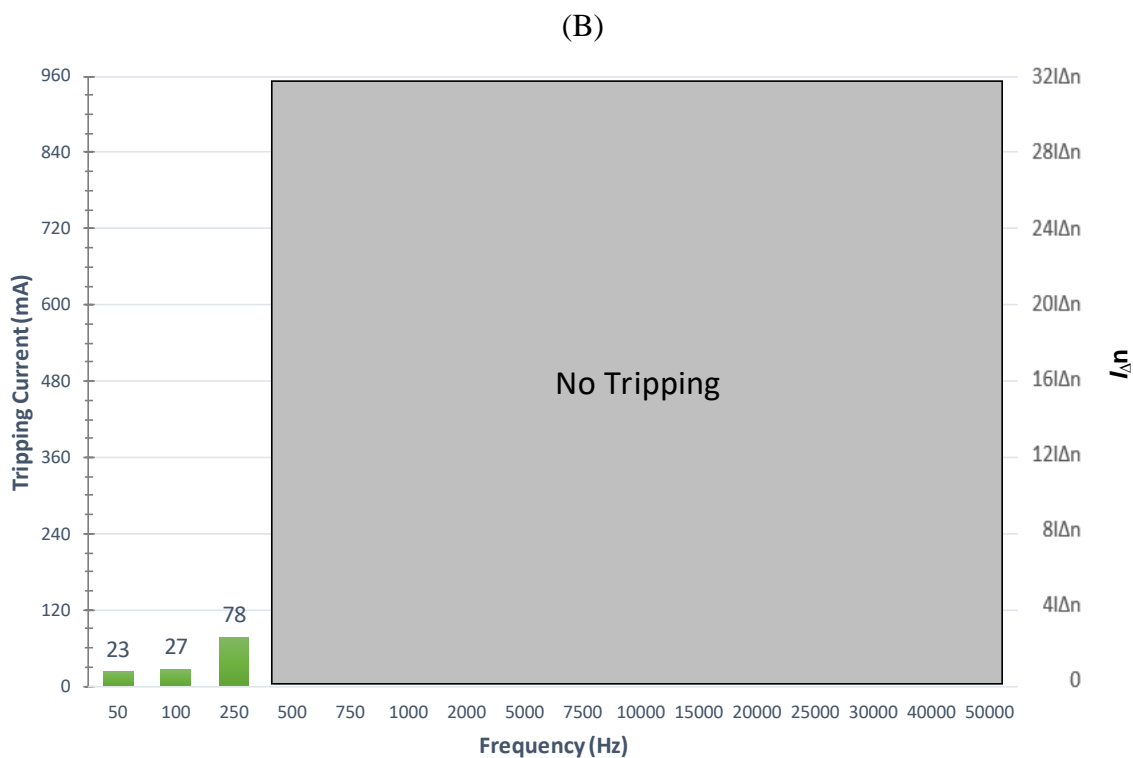
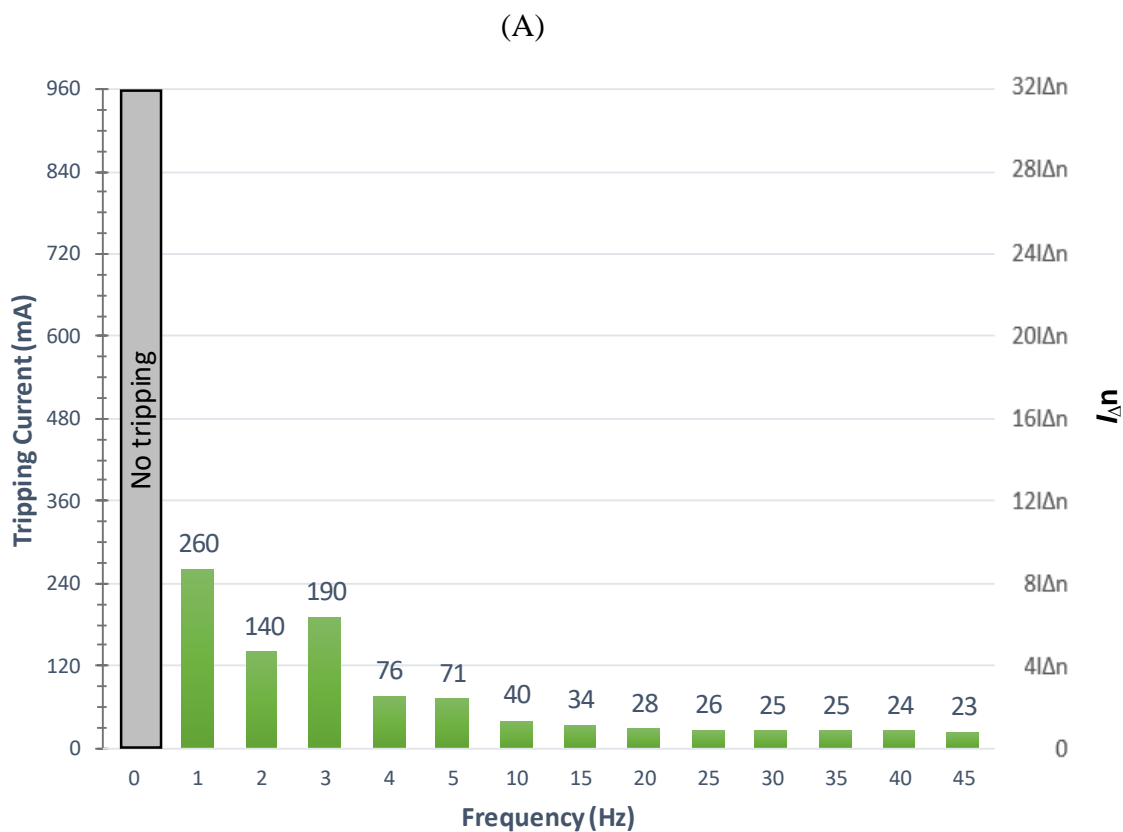

Figure 45: Tripping results of AC-type (30 mA) RCD (RCD_AC4) for the following slowly rising residual currents: (A) test results from DC (0 Hz) to AC 45 Hz, (B) test results from 50 Hz to 50000 Hz.



(B)

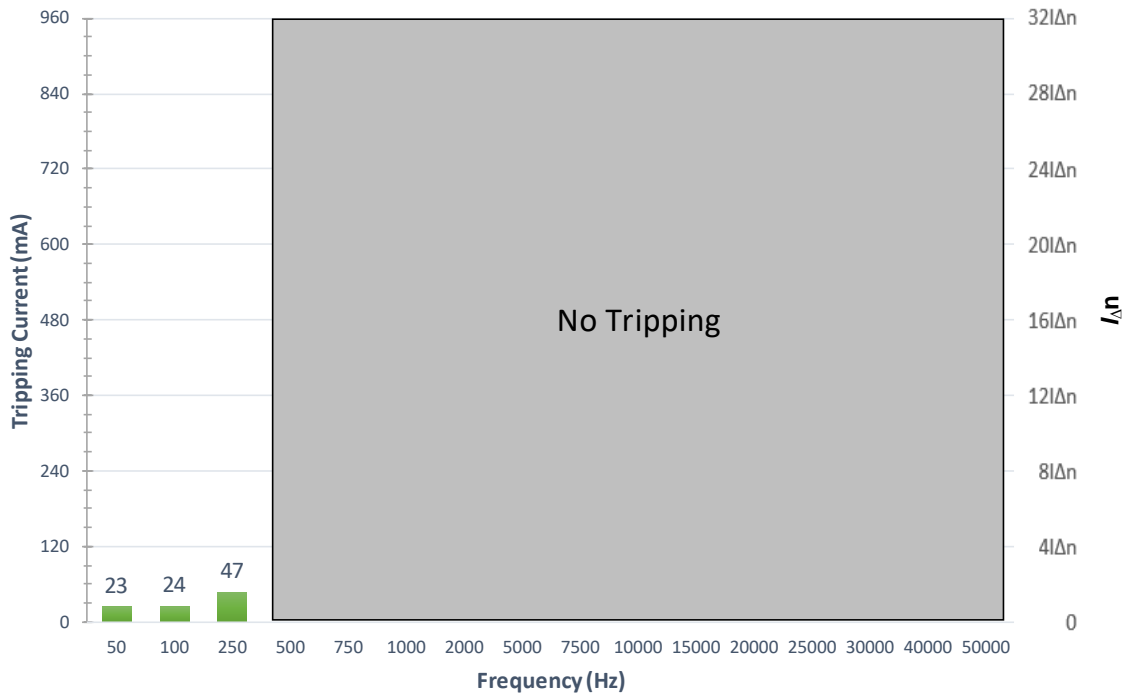
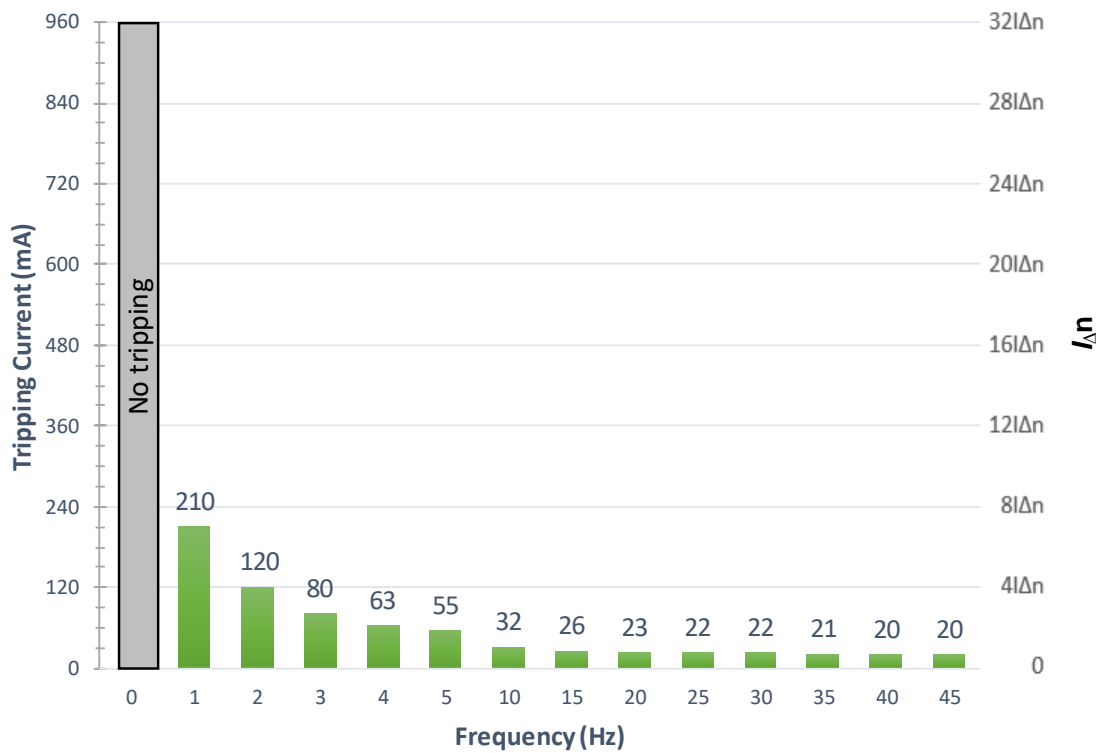

Figure 46: Tripping results of A-type (30 mA) RCD (RCD_A1) for the following slowly rising residual currents: (A) test results from DC (0 Hz) to AC 45 Hz, (B) test results from 50 Hz to 50000 Hz.

(A)



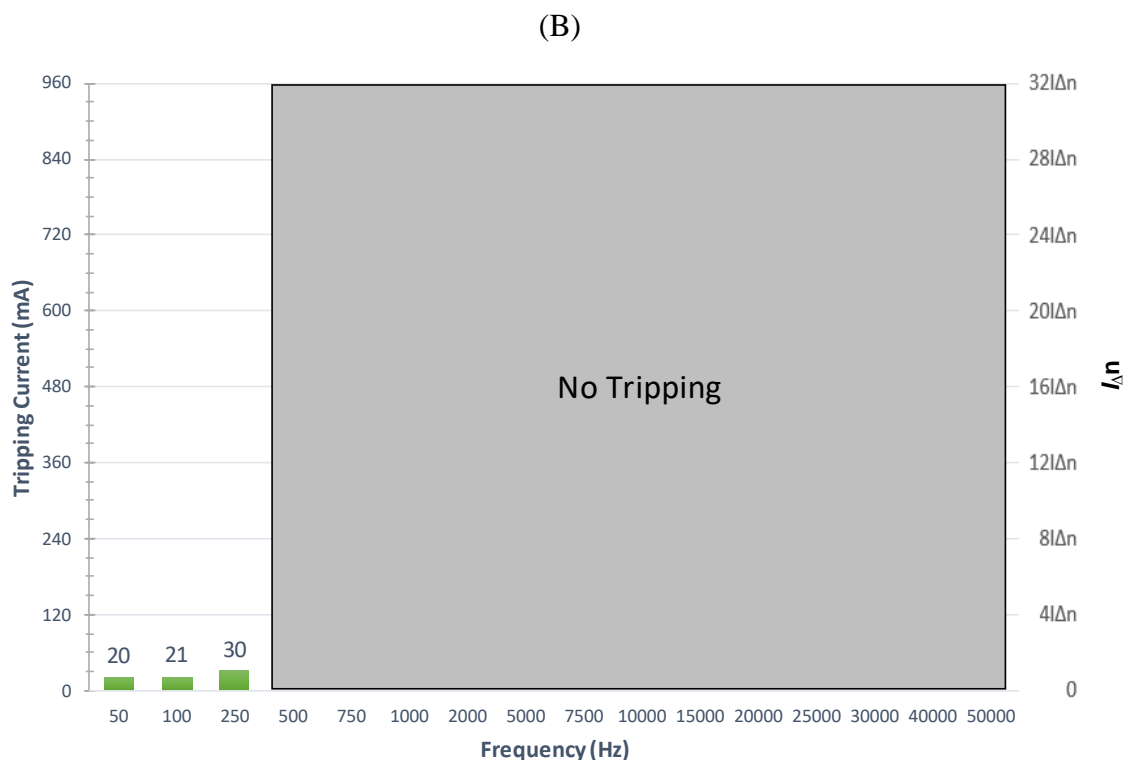

Figure 47: Tripping results of A-type (30 mA) RCD (RCD_A3) for the following slowly rising residual currents: (A) test results from DC (0 Hz) to AC 45 Hz, (B) test results from 50 Hz to 50000 Hz.

- B-type

The recorded test results of B-type RCDs (RCD_B1 and RCD_B2) are explained and presented in the Figure 48, Figure 49, Figure 50 and Figure 51. Being the most advanced type of RCD, B-type RCDs depicted a very interesting behavior during the testing mechanism. Figure 48 and Figure 49 explain the test results of RCD_B1. In Figure 48A, DC and low-frequency test results are drawn while including AC auxiliary supply of 230 V. Even in this case (auxiliary supply included), RCD_B1 failed to trip within permissible limits, $(0.5-1.0)I_{\Delta n}$, when DC residual current was supplied to it, instead it tripped carrying the residual current of almost 10 times bigger value (378 mA) than the rated one. However, from 1 Hz frequency and onwards, the behavior of RCD_B1 was positive. In Figure 48B, the recorded test results were carried out without auxiliary supply and are quite concerning. No tripping could be initiated on pure DC residual current and even no reaction was observed for AC residual current of 1 Hz frequency. This unsatisfactory behavior was observed until the frequency level of 15 Hz (Figure 48B). Almost same behavior was observed for RCD_B2 (Figure 50A), for low-frequency and DC residual current tests, the test results of RCD_B2 were quite positive when tests were carried out while including auxiliary supply. Yet again, the behavior of RCD_B2 is quite negative for the similar test while the auxiliary supply was absent (Figure 50B).

For the former part of the tests, RCD_B1 test results presented in Figure 49A are meant for high-frequency response verification, starting from 50 Hz (nominal frequency) while including auxiliary supply, and the tripping value shoots out of permissible range at 250 Hz and above. Also, from the frequency level of 20 kHz onwards, no reaction was observed. Worst was yet to be observed in Figure 49B, similar tests were repeated without including auxiliary supply and the RCD_B1 didn't trip at all from 500 Hz and above, the important point is that for each frequency the residual current was gradually raised to 1 A. For the RCD_B2, Figure 50A presents the test results in the presence of auxiliary supply, similar to the RCD_B1, results were not promising and RCD_B2 behaved negatively to the supplied residual currents even while including the auxiliary supply. It seemed that auxiliary supply didn't have any positive affect on RCD_B2 and it can be seen by comparing both results i.e., with and without auxiliary for RCD_B2 in the Figure 51A and Figure 51B. From all the aforementioned results, it seems that B-type RCDs from different manufacturers have different reactions to the same residual current waveforms. One important point is that both RCDs can only perform well (up to an extent) in cases when auxiliary supply was included.

- F-type

Figure 52 and Figure 53 depict the test results recorded using the F-type RCDs, RCD_F1 and RCD_F2, respectively. F-type is one of the most modernized types of RCD in terms of its design and ability to react to residual currents. As presented in Figure 52A and Figure 53A, the results obtained for low-frequency and DC were not up to the par and no reaction was recorded for DC earth fault current or for AC 1 Hz frequency level for both RCDs (RCD_F1 and RCD_F2). Moreover, up to the frequency level of 30 Hz, the tripping current achieved was out of the permissible range for RCD_F1. The results of RCD_F2 (Figure 53A) were the worst and for the low frequencies the tripping current jumped to quite a high value i.e., 870 mA which is almost 28 times higher than nominal. For high-frequency part of test, results are presented in Figure 52B and Figure 53B. Similar to previous types of RCDs tests and contrary to the hopes, reaction was almost similar (negative). From 250 Hz and above, the tripping current was outside the permissible range. Moreover, from the frequency level of 5000 Hz to 7500 Hz, RCD_F1 and RCD_F2 stopped tripping at all, although, both exposed to the residual current value of 1000 mA. Hence, even the latest design of RCDs, i.e., F-type, isn't good enough to be relied upon for electric shock protection in low voltage power systems.

TESTING OF PRE-EXISTING RESIDUAL CURRENT DEVICES

(A)

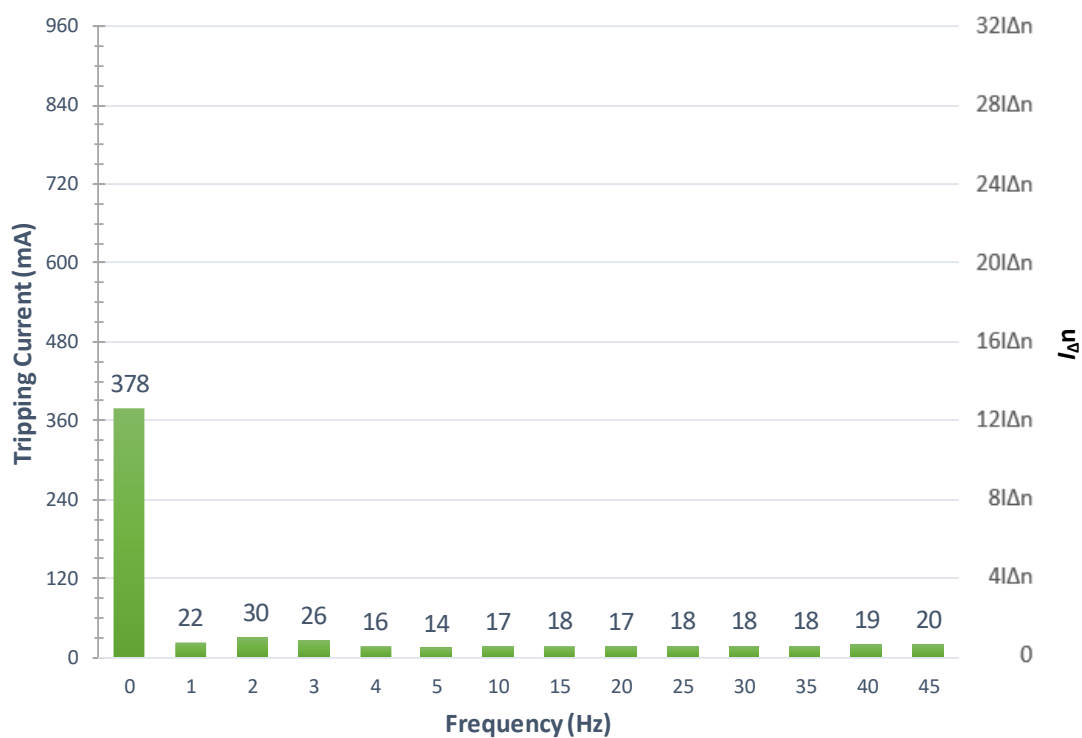

(B)

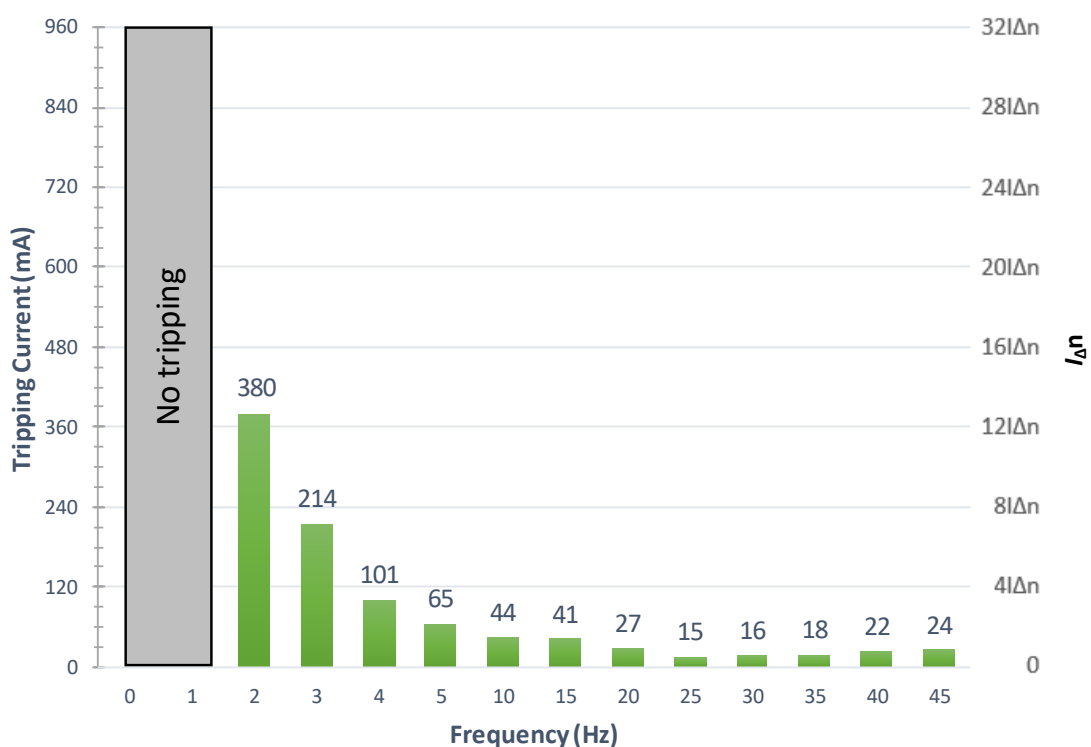

Figure 48: Test results of B-type (30 mA) RCD (RCD_B1) for slowly applied residual current from DC (0 Hz) to AC 45 Hz: (A) test results with AC (230V) auxiliary supply, (B) test results without AC (230V) auxiliary supply.



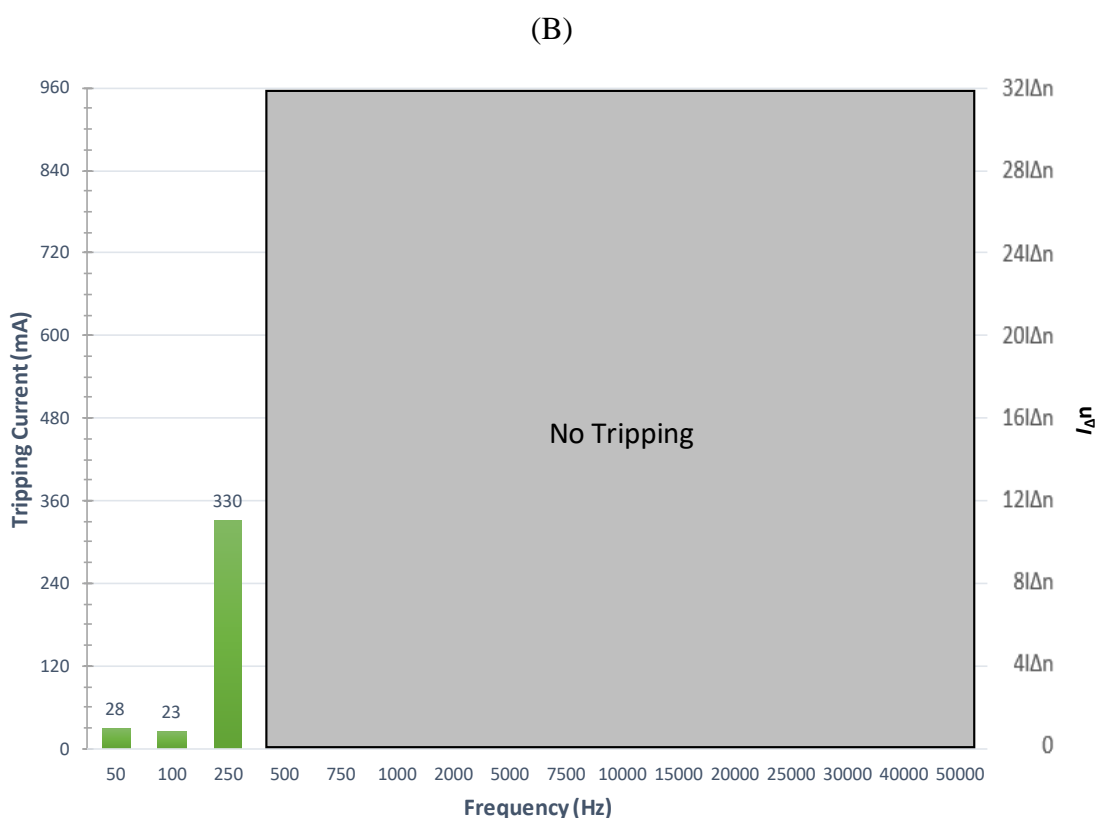
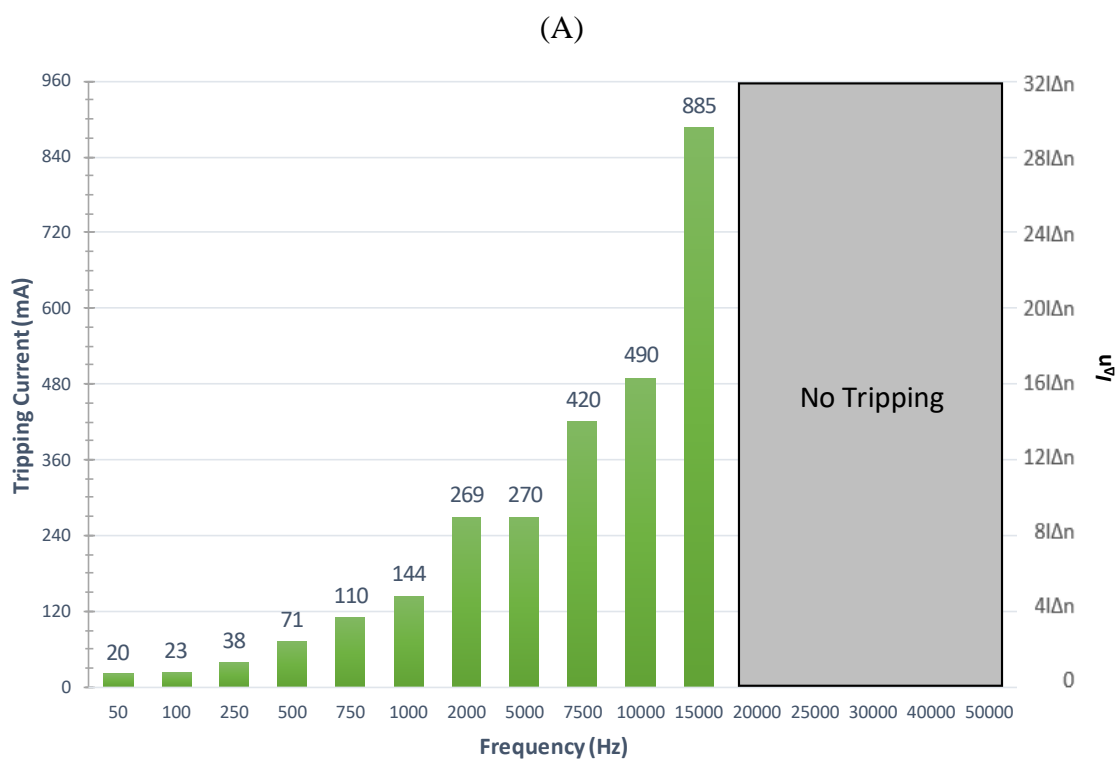

Figure 49: Test results of B-type (30 mA) RCD (RCD_B1) for slowly applied residual current from frequency 50 Hz to 50000 Hz: (A) test results with AC (230V) auxiliary supply, (B) test results without AC (230V) auxiliary supply.



TESTING OF PRE-EXISTING RESIDUAL CURRENT DEVICES

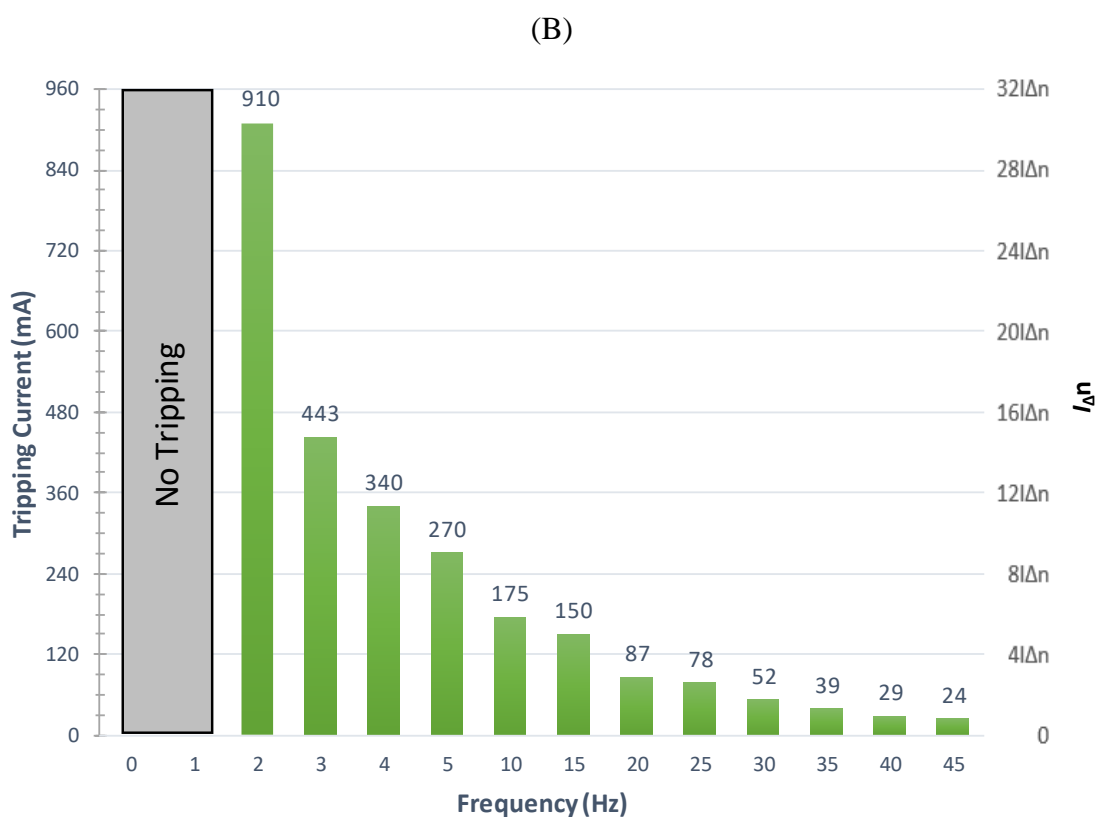
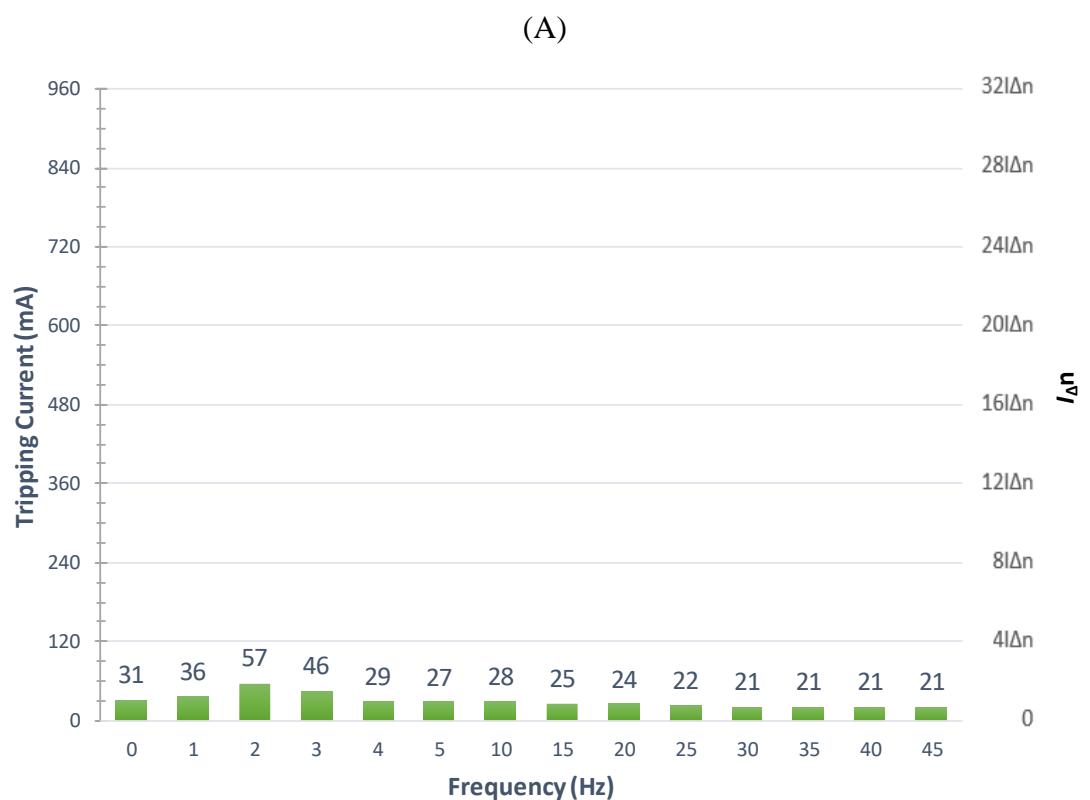

Figure 50: Test results of B-type (30 mA) RCD (RCD_B2) for slowly applied residual current from DC (0 Hz) to AC 45 Hz: (A) test results with AC (230V) auxiliary supply, (B) test results without AC (230V) auxiliary supply.



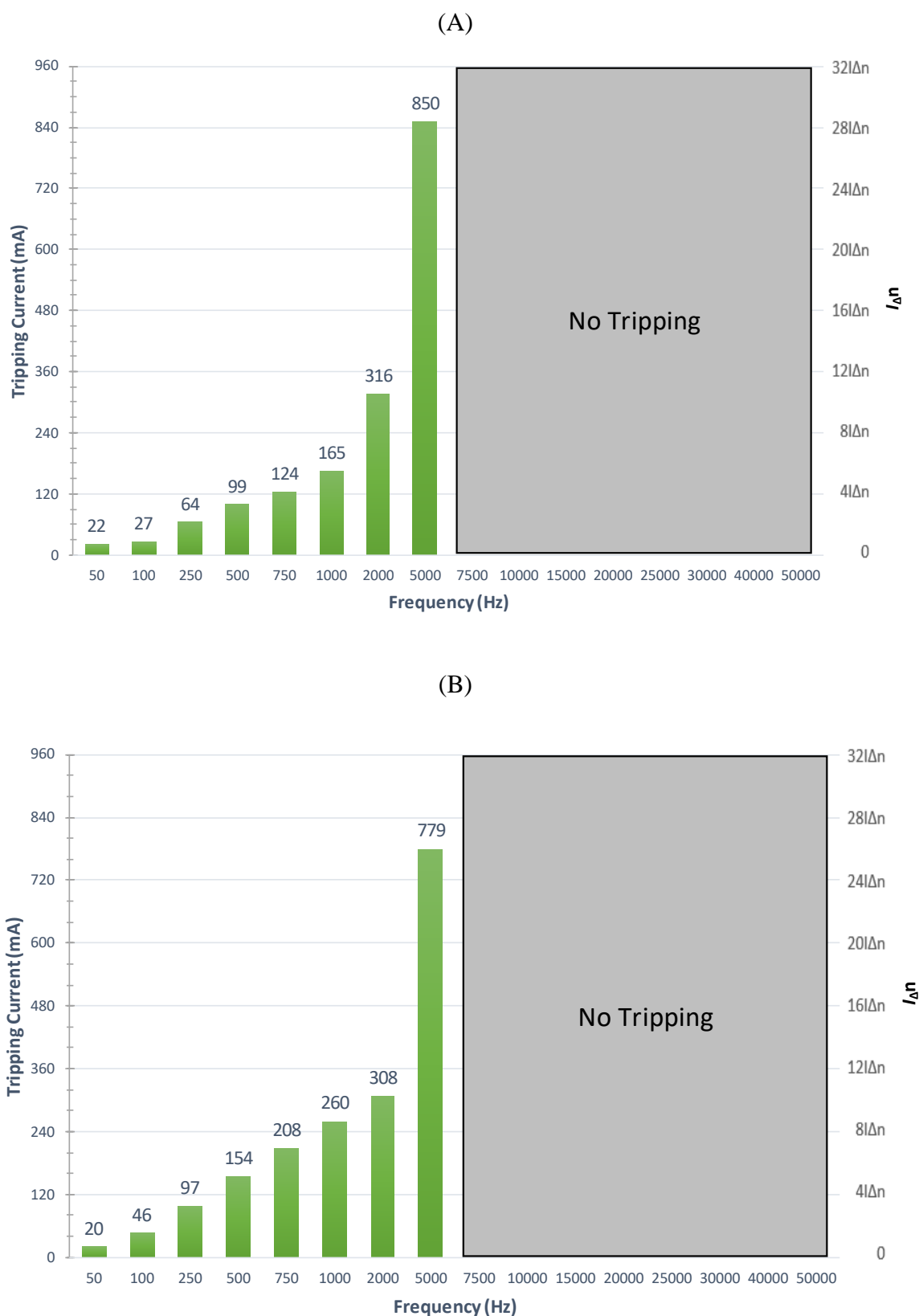

Figure 51: Test results of B-type (30 mA) RCD (RCD_B2) for slowly applied residual current from frequency 50 Hz to 50000 Hz: (A) test results with AC (230V) auxiliary supply, (B) test results without AC (230V) auxiliary supply.



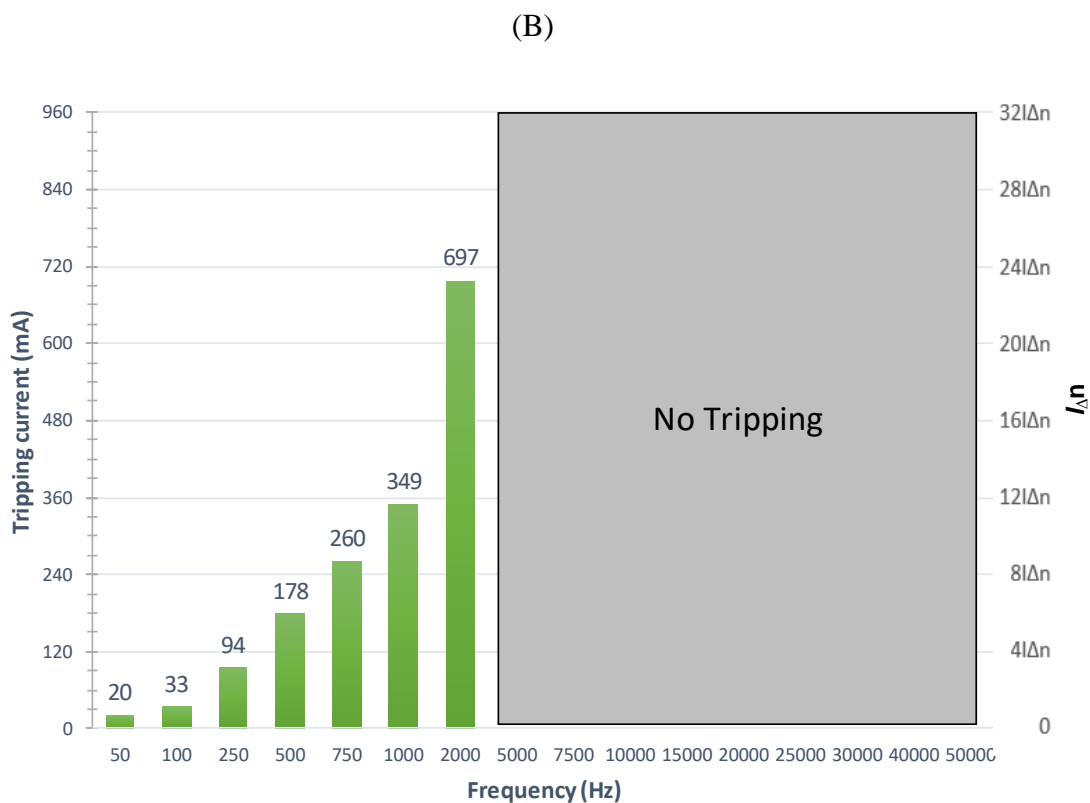
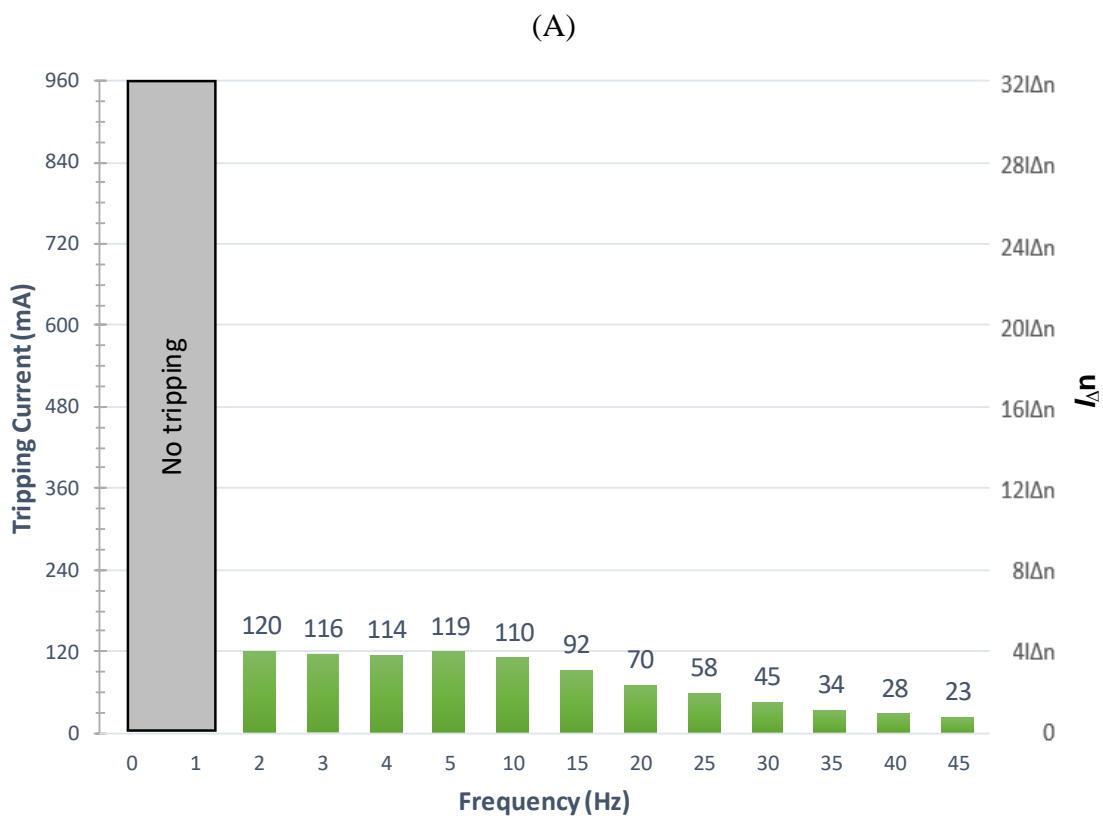

Figure 52: Test results of F-type (30 mA) RCD (RCD_F1) for the following slowly rising residual currents: (A) test results from DC (0 Hz) to AC 45 Hz, (B) test results from 50 Hz to 50000 Hz.



TESTING OF PRE-EXISTING RESIDUAL CURRENT DEVICES

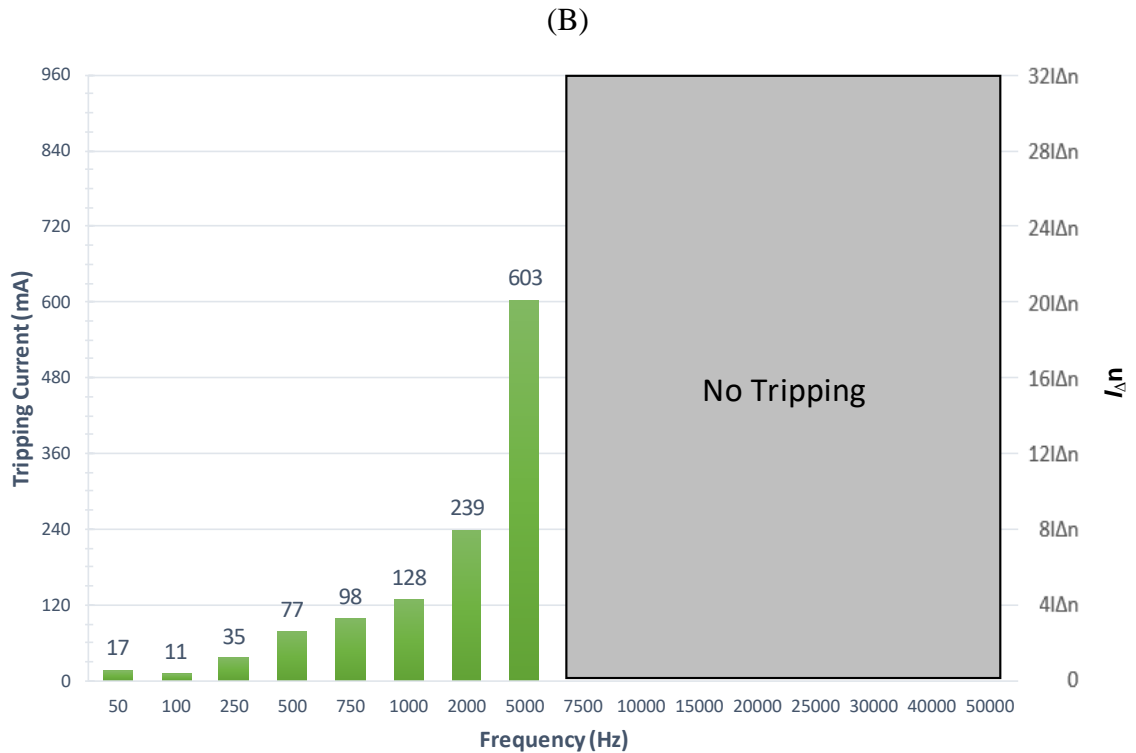
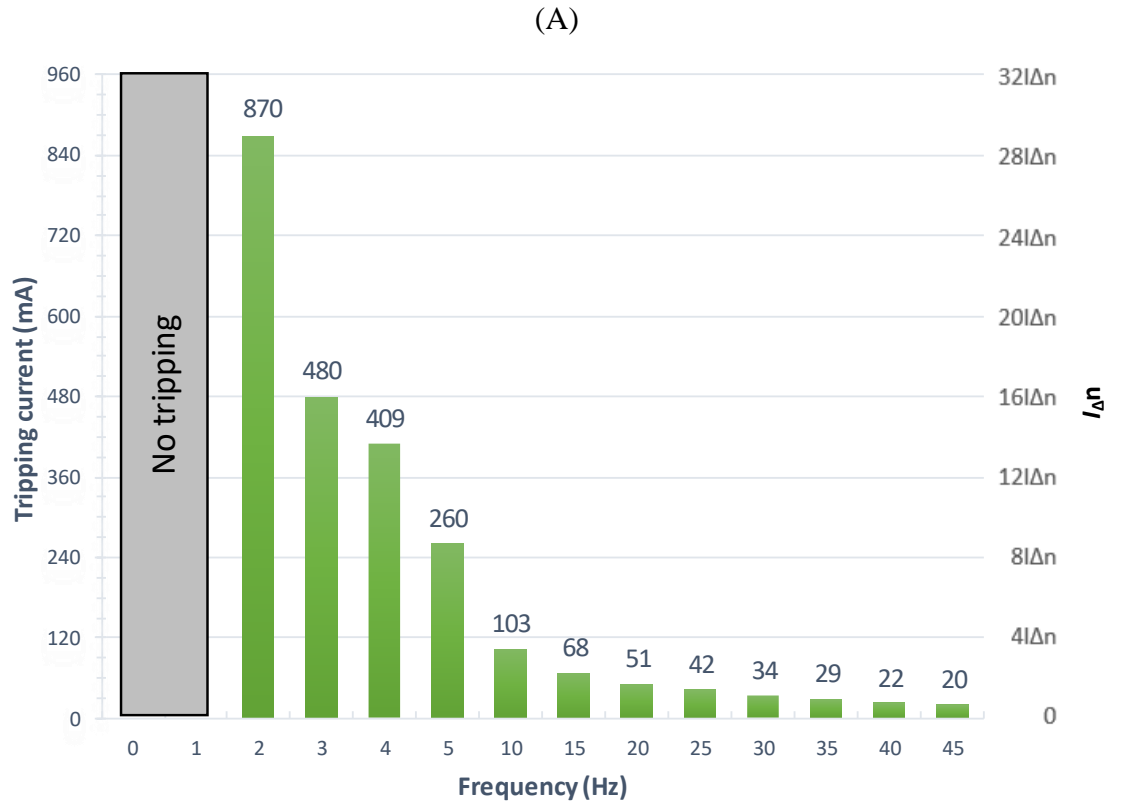

Figure 53: Test results of F-type (30 mA) RCD (RCD_F2) for the following slowly rising residual currents: (A) test results from DC (0 Hz) to AC 45 Hz, (B) test results from 50 Hz to 50000 Hz.

4 NEWLY DESIGNED RCD

4.1 Concept and design

The author of this work has performed extensive testing on other types of RCD (AC, A, B and F) and highlighted one of the most important concerns about electric safety in low-voltage power systems, i.e., the lack of tripping or tripping at very high values of residual current which is unsafe for an individual. In order to resolve the aforementioned issue, the author has proposed a new design of the RCD as presented in Figure 54. The aim of this new design is to provide effective protection against electric shock in abnormal conditions, most importantly with distorted earth fault current circuits and at very low frequencies, including DC residual current. Moreover, the primary goal of this new design is to overcome all the tripping issues that occurred in the previous chapter (Chapter 3) with various types of RCDs (A, AC, B, and F). For example:

- in the presence of a very high-frequency residual current,
- in the presence of exposure to mixed-frequency components, such as two frequency or residual current composed of three frequency components,
- in the presence of pure DC and residual currents based on very low frequencies (1 Hz, 2 Hz, 3 Hz etc.),
- and in the absence of an auxiliary supply for a relatively long time in the power network.

This newly designed RCD is capable of providing protection within the permissible range for rated residual current of 300 mA i.e., 150–300 mA of residual current satisfying the condition of $(0.5-1.0)I_{\Delta n}$. The choice of such a current $I_{\Delta n}$ is dictated by the relatively easy exemplary construction. Of course, it is possible to obtain other values of the rated residual operating current $I_{\Delta n}$ by adapting the design parameters of this protection (current transformer type, number of turns, relay type, etc.).

4.2 Equipment description

Figure 54 explains the newly designed RCD. It is designed with the help of a few electronic elements and an advanced current transformer responsible for maintaining the quality of the signal during transformation towards the secondary side, even at lowest and higher frequency values. Moreover, the test bench used to perform the testing of the newly designed RCD has been presented in Figure 55. It is the real image of the laboratory setup of the laboratory at Gdansk University of Technology.

The symbols used in Figure 54 are briefly explained in the caption of the said figure, however, a detailed description of the components used in the new design is as follows:

- C.B: circuit-breaker, responsible to isolate the source,
- RL: relay used in the design, typically an electromechanical relay that is used inside most of the pre-existing RCDs,
- BR: a bridge rectifier, responsible for the rectification of the output waveform from the latest current transformer; due to this solution, the secondary circuit (relay) gets independent of the frequency,
- VRS: variable resistance (optional), to have a controlled current in order to get the required value or not to damage due to overcurrent,
- CR: a step-down converter/adaptor, responsible to convert AC 230 V to DC 5 V,
- BY: a Li-ion cell battery with a capacity of 3400 mAh, responsible to provide a backup supply to the current transformer,
- SS: a specialised electronic circuit responsible for the charging surveillance of the battery and to cut-off the charging when not needed,
- BB: a boost converter, responsible to boost DC-DC voltage from approximately 5 V to 15 V, the output will be symmetrical of +15 V and -15 V, this is the voltage necessary for the performance of proposed current transformer,
- C.T: a current transformer or linear current transducer, responsible to carry out the transformation of the primary waveform (residual current) towards secondary side efficiently within the frequency band gap of 0 Hz (DC) to 200 kHz,
- PE: protective earthing,
- RCD: residual current device.

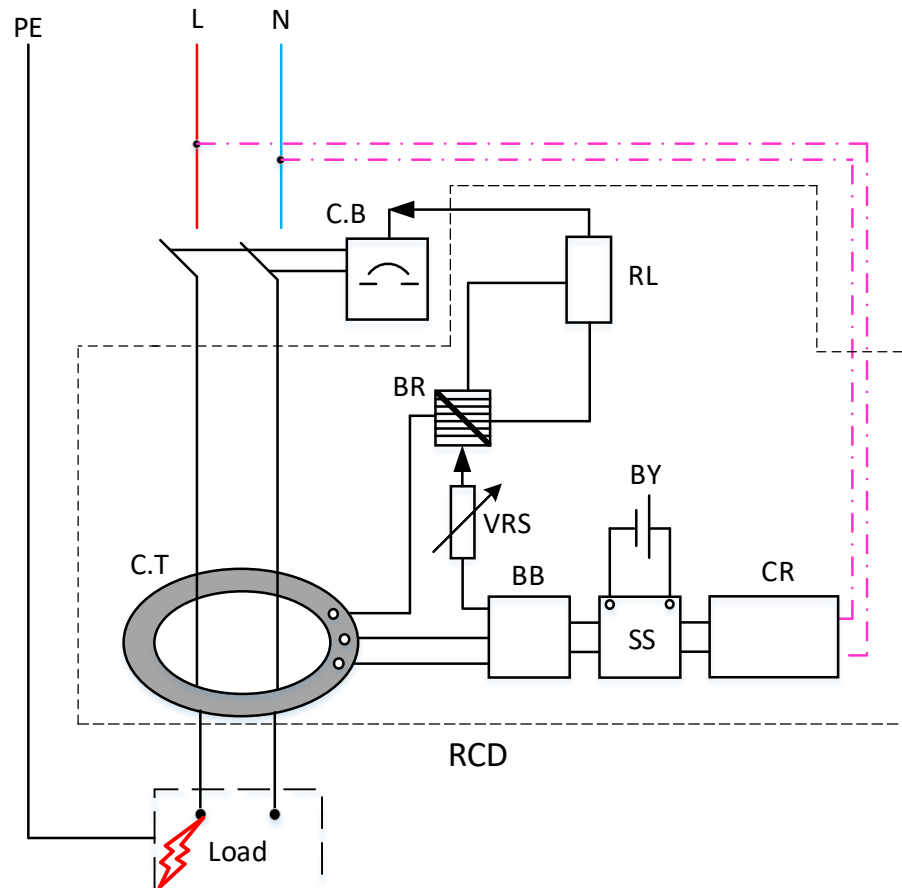

Figure 54: Newly proposed RCD invented in the laboratory of Gdansk University of Technology; C.B– circuit-breaker responsible for isolation of source, RL– relay, BR– bridge rectifier, VRS– variable resistor (optional), CR– adapter, BY– cell battery for backup, SS– circuit responsible for battery charging surveillance, BB– boost converter circuit, C.T– special current transformer, PE– protective earthing, RCD– residual current device.

4.3 Working

The newly designed RCD is capable of detecting and initiating the tripping mechanism while being exposed to distorted earth fault currents and to the DC residual currents as well. The supply of 230 V is connected to an adapter (CR) that steps-down and converts the AC 230 V to DC 5 V. This was done to perform the charging function of the backup battery (BY). The backup battery is an essential element of the proposed RCD, as the current transducer's efficiency is dependent on the auxiliary supply voltage of 12 V to 15 V. In the extreme or worst cases, if the auxiliary supply voltage cuts off during the faulty scenario, there is a battery backup to ensure the electric shock protection in the presence of newly proposed RCD. For B-type RCDs, the most advanced type of RCD, didn't perform well with the applied residual currents as explained in Chapter 3. However, the performance of B-type RCD gets worst in the absence of auxiliary supply voltage. In order to overcome this concern, a battery is proposed. The author of this work checked the time-span for the battery backup and it can be said without any doubt that it is more than three hours (180 minutes-which can be extended further). However, this battery provides a nominal output voltage equal to 3.7 V and as per the



properties of the current transducer (C.T), 12 V to 15 V are required as an auxiliary supply. So, to overcome this, a DC-DC boost converter (BB) with symmetrical supply (+15 V, -15 V) was installed to ensure the availability of the required auxiliary supply to the C.T. Once the C.T is supplied with the uninterrupted auxiliary supply of ± 15 V, it can perform its designated functions. There is a bridge rectifier (BR) circuit, that allows only forward biasing and is installed between the relay (RL) and C.T, the purpose of this BR is to rectify the receiving signal and change it to a unidirectional waveform to attain a good quality signal necessary to perform the tripping of the relay (RL). An example waveform in Figure 56 explains the transformation mechanism of C.T during the operation of newly designed RCD. To verify the behaviour of this newly designed RCD, it was exposed to the rigorous testing phenomena, that was used to verify the behaviour of all types of RCDs (AC, A, B and F) as explained in the Chapter 3 of this dissertation.

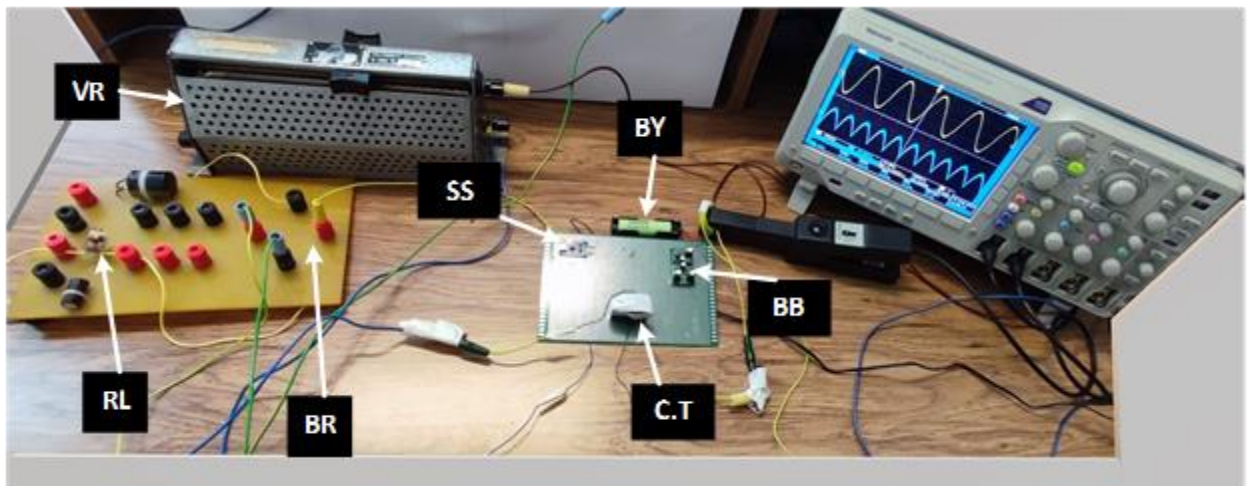

Figure 55: A lab photo of newly designed RCD.

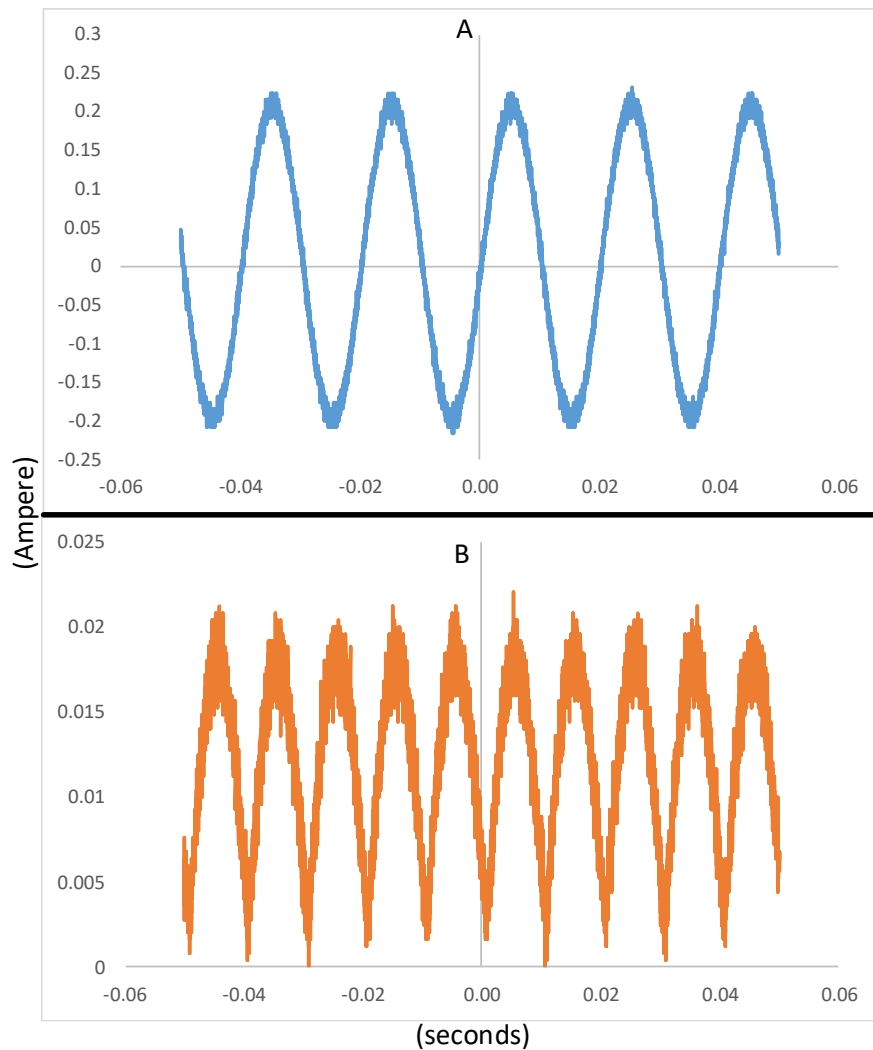

Figure 56: Oscillogram waveform recorded during testing of newly designed RCD: A – recorded waveform of primary operation (sample of earth fault current) of C.T, B – recorded waveform supplied to the relay (RL) (shows the unidirectional/rectified waveform).

4.4 Test results

Similar to the previously performed tests, the newly designed RCD was exposed to the following tests:

- suddenly applied residual current starting from 0 Hz (DC) and going up to AC 40 kHz, the frequency mentioned here is referring to the pure sinusoidal residual currents,
- suddenly applied residual current composed of mixed-frequency components, this is further extended to two mixed-frequency tests and three mixed-frequency tests,
- slowly applied residual current starting from 0 Hz (DC) and going up to 30 kHz (first category) / 40 kHz (second category)/ 50 kHz (extended test).

4.4.1 Response to suddenly applied pure DC and very high-frequency

Figure 57 presents the test results of pure sinusoidal suddenly applied residual current, except for DC (0 Hz), where waveform was not sinusoidal. The tested frequencies were as follows:

- Starting from frequency (0 (DC) – 1 – 2 – 3 – 4 – 5 – 10 – 25 – 50 – 150 – 300 – 500 – 1000 – 2000 – 5000 – 8000 – 10000 – 14000 – 18000 – 22000 – 25000 – 30000 – 35000 – 40000) Hz.

The test results came up as positive, new RCD was tested and results shown in Figure 57 have maximum 5 times the rated residual operating value ($I_{\Delta n}$). The aim is to attain tripping within the range of $(0.5-1.0)I_{\Delta n}$ and it is not necessary to increase the applied residual current further once the RCD has shown a positive response (tripping) initially on rated residual current of $I_{\Delta n}$. Fortunately, upon all the frequency stages, the new RCD tripped on the lowest provided rated residual operating current, i.e., $I_{\Delta n}$. The suddenly applied residual current holds the most importance among all types of tests as it represents a real-life scenario. For instance, when an individual comes into contact with a live conductor and begins to receive an electric shock, their body experiences a fixed and sudden amount of current that travels towards the earth, thereby, the body becoming a path for the current. To save an individual from an electric shock, it is necessary to verify the behavior of the RCD by exposing them to a series of frequency tests based on suddenly applied scenario. The most important factor here, is that all the above-mentioned tests have been carried-out without any external auxiliary supply and the whole RCD circuit was powered by an internal battery system (SS and BY). Hence, the newly designed RCD has the capability to perform positively against very low and very high frequencies even in the absence of auxiliary supply (external) of the power supply network.

4.4.2 Response to mixed-frequency residual currents

Figure 58 and Figure 59 explain the test results recorded for residual current composed of the two mixed-frequency components and three mixed-frequency components, respectively. Once again, the results were recorded when the newly designed RCD had no externally provided auxiliary supply. All the tests were carried out with the help of battery (BY) of the RCD and all the results came out positive. Considering the tests explained in Figure 58, it is evidently clear that the newly proposed design has performed well and positively for the two mixed-frequency component waveforms, which are basically not purely sinusoidal current shapes. For this test, the chosen frequency components are 50 Hz and one higher frequency component (1000 Hz/ 2000 Hz). The ratios were changed simultaneously, as explained in the Chapter 3. For all the ratios, even the highest one, 50 Hz (10%) and 2000 Hz (90%), the results came out positive and newly designed RCD tripped successfully. Similar behaviour of the new RCD was observed and recorded in the case of residual current composed of three-frequency components in Figure 59. The results of tripping were positive even for the most complex ratio of 50 Hz (5%), 150 Hz (25%) and 2000 Hz (70%). It once again proves that new RCD is

capable for providing electric shock protection and fire protection even in worst case scenarios of mixed-frequency tests.

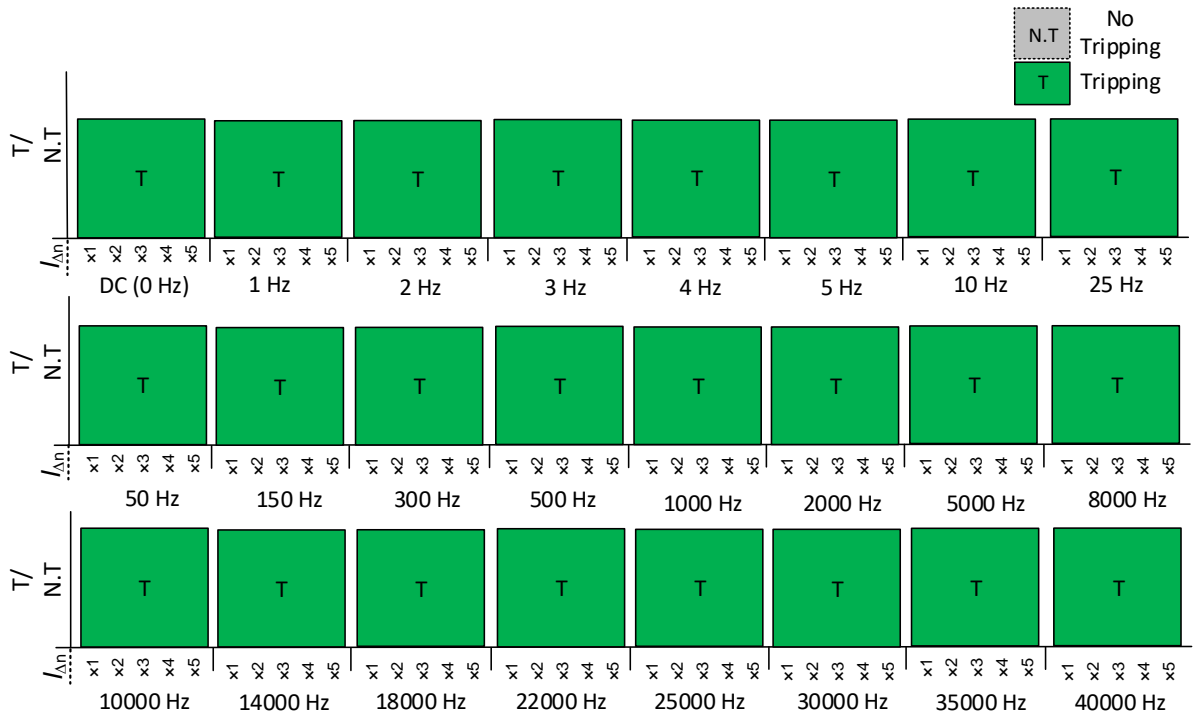

Figure 57: Suddenly applied residual current – Tripping results of newly designed RCD – residual current starting from DC (0 Hz) up to 40000 Hz.

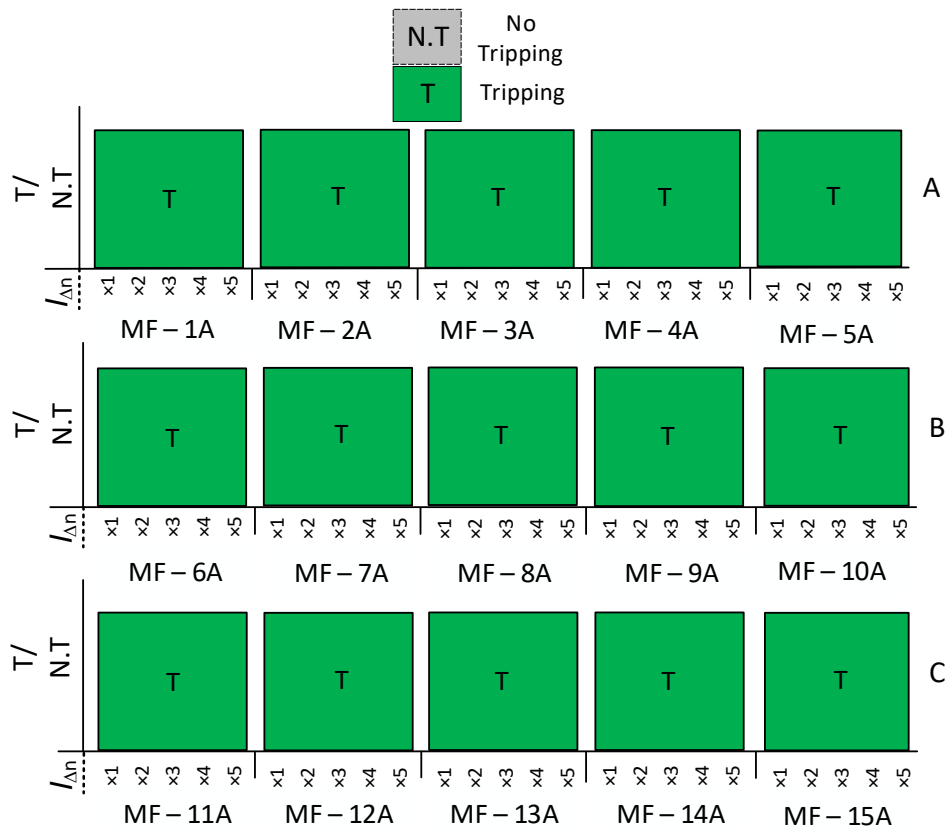

Figure 58: Tripping results of the newly designed RCD – for the mixed-frequency waveforms composed of two components: fundamental frequency (50 Hz) and high-frequency component: A) 500 Hz, B) 1000 Hz, C) 2000 Hz; MF – mixed-frequency waveform according to Table 10.

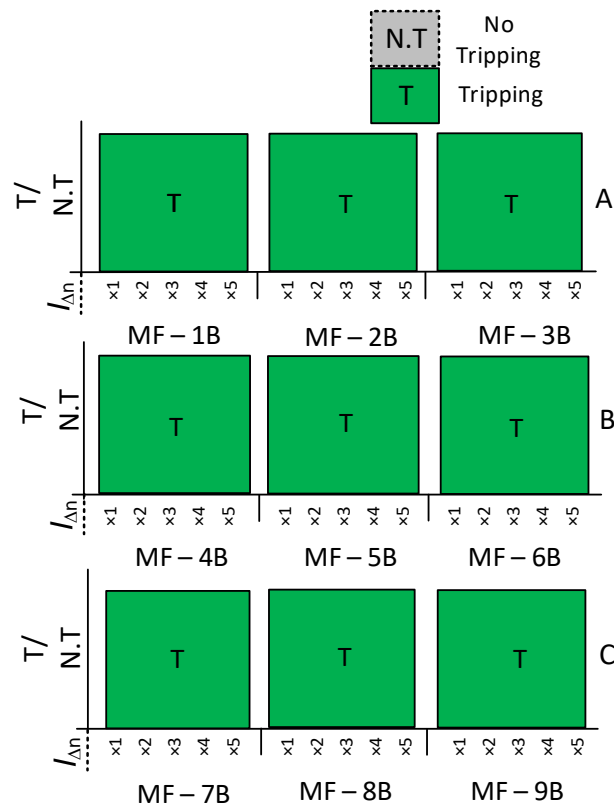

Figure 59: Tripping results of the newly designed RCD for the following mixed-frequency waveforms composed of three components including 50 Hz, 150 Hz and third higher frequency component of: A) 500 Hz B) 1000 Hz C) 2000 Hz; MF – mixed-frequency waveform according to Table 11.

4.4.3 Response to slowly rising residual current

In this test, the author of the study has proposed new RCD with behavioral flexibility that can be observed in the slowly rising residual current tests. The new design can have two different categories subject to the needs of consumer and the requirements of the circuit. Both categories of RCDs have been tested in the lab as follows:

- First category – starting from 0 Hz (DC) and going step-wise to the frequency level of 30000 Hz. Selected frequency levels were: (0 – 1 – 2 – 3 – 4 – 5 – 10 – 50 – 300 – 500 – 1000 – 2000 – 5000 – 10000 – 14000 – 18000 – 22000 – 25000 – 30000) Hz. This scheme specifically targets tentative consumers seeking electric shock protection in circuits with the hazards of DC residual currents or very low frequencies. The proposed RCD will provide protection starting from DC (0 Hz) and up to 30000 Hz of frequency,
- Second category (after a minor change in the structure of RCD) – starting from 50 Hz to high-frequency level of 40000 Hz. Selected frequency levels were: (50 – 150 – 300 – 500 – 1000 – 2000 – 5000 – 8000 – 10000 – 14000 – 18000 – 22000 – 25000 – 30000 – 35000 – 40000) Hz. This scheme, however, focuses on the electric circuits which are prone to residual currents of very high-frequency. Hence, the proposed RCD

will provide electric shock protection starting at 50 Hz, which is the nominal frequency, and going up to 40000 Hz.

As mentioned above, the results of both categories have been presented in Figure 60A and Figure 60B, based on slowly rising residual current. Figure 60A explains the test results from DC (0 Hz) up to AC 30000 Hz and Figure 60B presents the results in steps from 50 Hz to 40000 Hz. The tests based on slowly rising currents are usually the toughest ones to get accurate readings of the tripping current. To perform this test, readings and results were verified with the help of an oscilloscope to get accurate RMS values of the operating residual current. In all the test results, the tripping value was within the limits defined by the standards (highlighted with a red colour line). Even for DC (0 Hz) in Figure 60A, it is visible that RCD tripped within permissible range of rated residual current i.e., $(0.5-1.0)I_{\Delta n}$, which is a good sign for electric shock protection. The author of this study has also performed the test results for 45000 Hz and 50000 Hz (extended tests) and the obtained tripping results were only 10–20% above the rated value $I_{\Delta n}$. The most important factor for this test as well, is that all slowly rising residual current tests were carried out without any auxiliary supply. Instead, the tests were carried out with the help of the battery power (SS and BY) included in the new design.

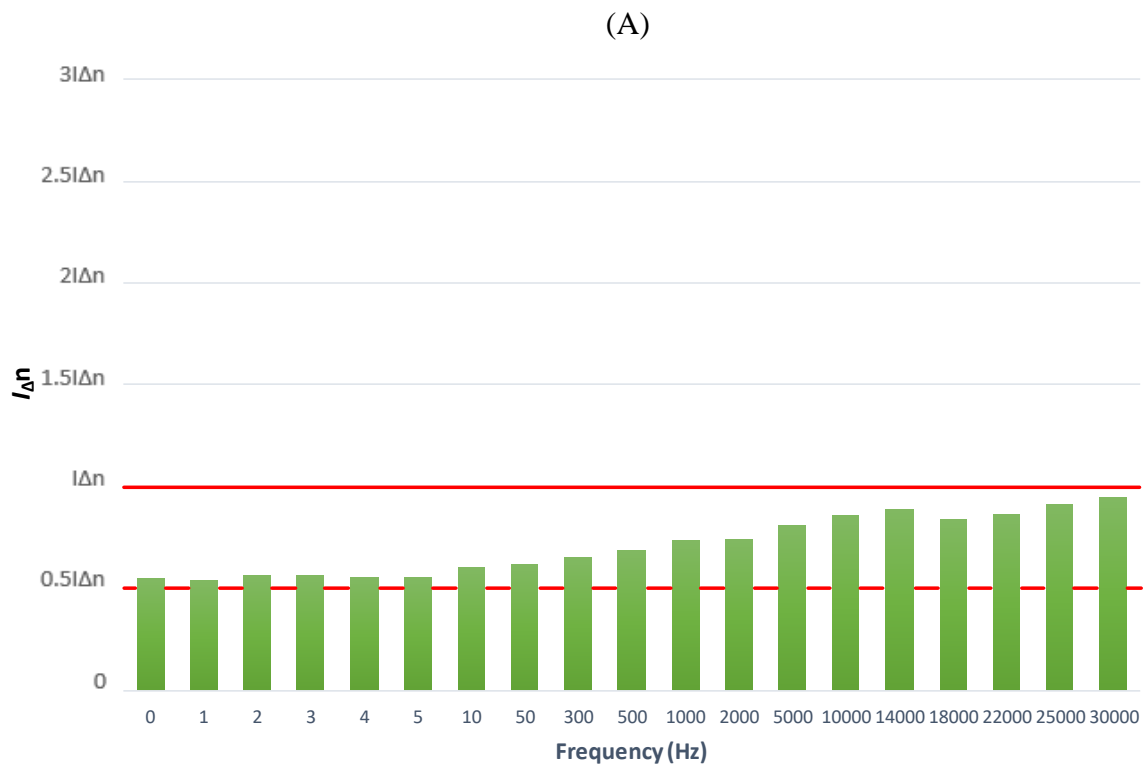

(B)

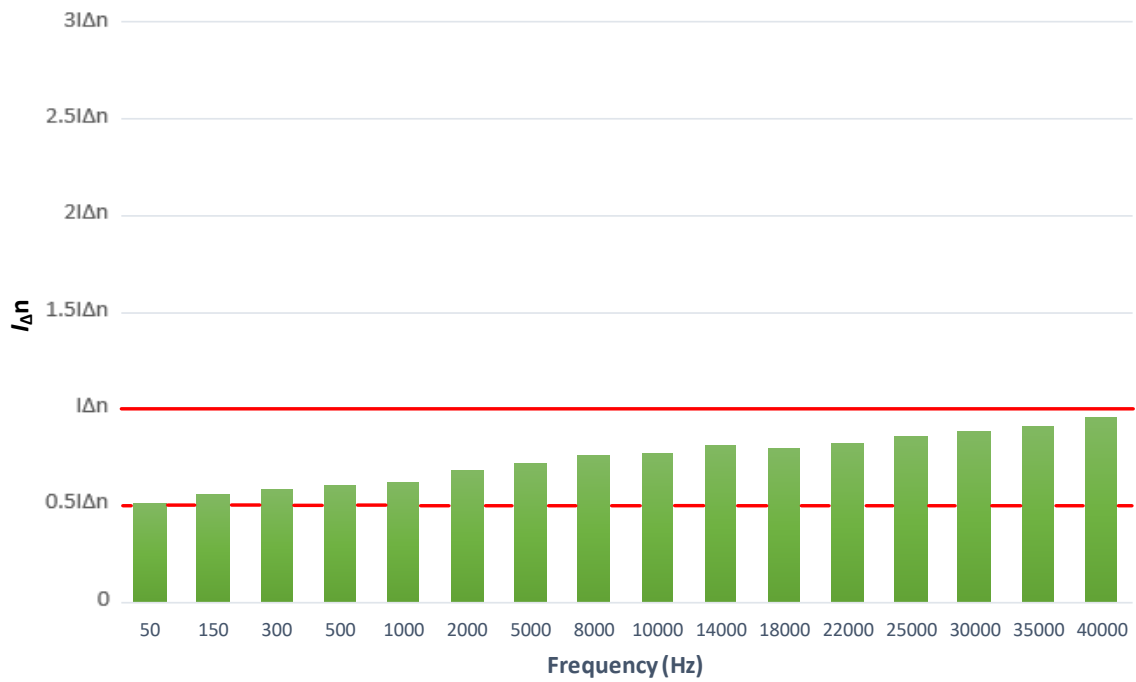

Figure 60: Test results of newly designed RCD for the following slowly rising residual currents: (A) test results from 0 Hz (DC) to AC 30000 Hz (first category construction), (B) test results from 50 Hz to 40000 Hz (second category construction).

5 SUMMARY AND CONCLUSION

The need to execute this research was felt due to rapidly increased use of power electronic converters, laptop and mobile adapters, electric vehicles and other battery storage systems and renewable energy resources that primarily work on the basis of DC networking. The safety from electric shock protection is enforced by many international standards and regulations, many of them have been mentioned and discussed previously in this dissertation. Those regulations obligate the use of residual current device (RCD) in a low-voltage power system to ensure the individual's safety. However, all the aforementioned equipment, also known as modernisation of electrical systems, has made the operation of RCD quite doubtful due to the presence of distorted earth fault currents. Such earth fault currents may result into residual currents which are not sinusoidal and are not suitable to be detected by any existing type and design of RCD. This is proven by a series of tests as explained in Chapter 3 of this dissertation, where most commonly used types of RCD (AC, A, B and F) are thoroughly tested and behaviour is examined quite minutely as per standards and permissible limits. Majority of the tests have presented negative results and shown unsatisfactory behaviour which is, for sure, not enough to ensure human life safety in case of electric shock.

To resolve the aforementioned problems, the author of this dissertation has presented a novel idea and design for the RCD that has been proven to be more effective against 'abnormal' residual currents and it is claimed by the author that the newly proposed design has the capability to supersede the existing/old design of the RCD. The new design then went through the rigorous testing mechanism, the same as pre-existing RCDs were exposed to, in Chapter 4 and results were up to the mark, positive and well within the permissible range of rated residual operating current $(0.5-1.0)I_{\Delta n}$. The new RCD has proven itself worthy against high-frequency testing, low-frequency tests, mixed-frequency tests and DC residual current as well. It was exposed to such residual currents multiple times and each time the RCD has shown tripping positively within permissible ranges defined by standards.

Again, the most important advantage of this new design is that it not only covers the detection of residual currents within a wide range of frequencies, but also provides protection without any external auxiliary supply as needed for the efficient operation of B-type RCD. That is why, B-type RCD tests in Chapter 3 were carried out in the absence of auxiliary supply to highlight the alarming situation. This can be extremely problematic for one of the most advanced types of RCD (B-type), if during faulty scenario the auxiliary supply voltage is

disconnected. The results of B-type RCD in Chapter 3 were quite unsatisfactory, especially for the case of ‘without auxiliary supply’. Contrary to that, in order to provide a solution, this new design can perform its designated function efficiently even in case of faulty condition when the supply cuts-off and no auxiliary supply is provided to the protection equipment in order to perform its dedicated function.

Hence, it can be claimed that this new design is more beneficial and efficient than the existing ones. It can provide electric shock protection in the presence of very low-frequency (even smooth DC), mixed-frequency components and is also suitable for very high-frequency. Hence, the statement of thesis mentioned in Chapter 1, topic 1.3, is assumed to be correct and came out as positive. Moreover, the new design has been submitted as a patent application number P.446907 [63] to the Patent office of Republic of Poland.

In a synthetic description, the most important achievements of the author of the doctoral dissertation include:

- broad recognition of the current state of knowledge about the operation of RCDs in modern power systems,
- conducting extensive laboratory tests to examine the operation and response of generally available RCDs in the case of earth fault/residual current waveforms that may appear in modern electrical systems,
- indication of deficiencies in the operation of these RCDs, which may result in ineffective protection against electric shock or fire,
- construction of a new RCD that works also in extreme situations when other RCDs may not work properly, especially in the absence of auxiliary supply,
- conducting positive experimental verification of the proposed RCD.

6 FUTURE WORK

Tentative future study might focus on some potential topics or aim to improve and enhance the capabilities of existing 300 mA design of RCD. Initially, the possibility for increasing the tripping sensitivity (rated residual operating current 30 mA or 100 mA), in order to achieve lower current detection will be explored. This will help broaden the operating range, particularly for environments that has the requirement of highly sensitive electrical safety/protection. Additionally, the second aim is to optimize the proposed design to support a wider range of frequencies (higher than 40 kHz), more efficiently. That may involve incorporating new and more advanced components, resulting in a better response time and reliability. Finally, rigorous out-of-lab testing (field test) in the presence of various faulty scenarios would be helpful in presenting the practical behavior and performance of the new design and may highlight further areas for refinement and optimization.

LIST OF TABLES

Table 1: Current transformer composition material used for the RCD type AC and type A [33].....	16
Table 2: Types of RCDs with respect to operational characteristics.	20
Table 3: Types of RCD and their voltage ratings with respect to number of poles [2], [48].	22
Table 4: Symbols and inrush current capacity [49], [50].....	23
Table 5: Limits for rated residual operating current explained in IEC/HD standard.....	24
Table 6: Time of isolation stated by standard HD 60364-4-41 [1].....	25
Table 7: RCD's tripping current in connection with permissible time.....	26
Table 8: Power (thermal) generated by leakage current.	30
Table 9: List of tested RCDs.....	37
Table 10: Sample waveforms for mixed-frequency tests based on two components; MF – mixed-frequency.	44
Table 11: Sample waveforms for mixed-frequency tests based on three components; MF – mixed-frequency.	47
Table 12: List of RCDs tested under mixed-frequency waveforms.	49
Table 13: List of tested RCDs for (suddenly applied) DC residual current.....	66
Table 14: List of selected RCDs for slowly rising residual current tests.....	72



LIST OF FIGURES

Figure 1: P. Schnell's design of residual current device; A – current transformer (C.T), B – primary side of C.T, C – secondary side of C.T, D – relay, and E – switching tool. [14]....	9
Figure 2: Early model of residual current device; voltage-dependent RCD with a diode bridge and overcurrent release mechanism on secondary circuit of current transformer; $I(p)$ – transformer's primary current, $I(sec)$ – transformer's secondary current, A – relay, B – overcurrent release device, C – switching equipment, D – current transformer.....	10
Figure 3: RCD model with impulse triggering circuit; $I(p)$ – primary current of transformer, $I(p)$ – transformer's primary current, $I(sec)$ – transformer's secondary current, A – diode, B – charge storage equipment, C – electronic switching equipment, D – current transformer, E – relay, F – switching equipment.....	11
Figure 4: Modern day design of residual current device; $I(p)$ – transformer's primary current, $I(sec)$ – transformer's secondary current, T – test button. A – matching electronic circuit, B – relay, C – switching equipment, D – current transformer, E – current limiting resistor for testing circuit.....	12
Figure 5: Structure of polarized electromechanical relay; 1: The stage of electromechanical relay before tripping, 2: The stage of relay after tripping; A – spring, B – moveable armature, C – yoke, D – permanent magnet, E – coil of current transformer.	14
Figure 6: Structure of non-polarized electromechanical relay; 1: The stage of electromechanical relay before tripping, 2: The stage of relay after tripping; A – spring, B – moveable armature, C – trigger coil, D – flux produced by coil's winding, E – permanent magnet, F – flux produced by permanent magnet, G – yoke.	15
Figure 7: Internal circuitry of a current transformer of a residual current device; V – secondary voltage of current transformer; V – secondary voltage of current transformer..	17
Figure 8: Modern two – iron core transformer RCD for AC residual current, smooth and pulsating DC earth fault residual currents; A – relay dedicated for smooth DC, B – relay, C – switching equipment, D – current transformer (for smooth DC), E – current transformer (for AC and pulsating DC), F – current limiting resistor for testing circuit.	18
Figure 9: Time – current characteristics for two types of RCDs; without delay RCD or short delay (with symbol G): $I_{\Delta n} = 30 \text{ mA}$; RCD with delayed tripping (with symbol S): $I_{\Delta n} = 300 \text{ mA}$ [51].....	23
Figure 10: Time – current characteristics for effects of AC current (15-100) Hz on humans; V.F – ventricular fibrillation; based on [62].	29
Figure 11: High-frequency laboratory test bench for RCD testing.....	37
Figure 12: Test results of AC-type (30 mA) RCDs – residual current with pure sinusoidal waveform from 50 Hz up to 50000 Hz: A) RCD_AC1, B) RCD_AC2, C) RCD_AC3, D) RCD_AC4, and E) RCD_AC5.	39
Figure 13: Test results of A-type (30 mA) RCDs – residual current with pure sinusoidal waveform from 50 Hz up to 50000 Hz: A) RCD_A1, B) RCD_A2, C) RCD_A3, D) RCD_A4, and E) RCD_A5.....	41
Figure 14: Test results of B-type (30 mA) RCD (RCD_B1) – residual current with pure sinusoidal waveform from 50 Hz up to 50000 Hz: A) with auxiliary supply, B) without auxiliary supply.....	42

Figure 15: Test results of B-type (30 mA) RCD (RCD_B2) – residual current with pure sinusoidal waveform from 50 Hz up to 50000 Hz: A) with auxiliary supply, B) without auxiliary supply.....	42
Figure 16: Test results of F-type (30 mA) RCDs – residual current with pure sinusoidal waveform from 50 Hz up to 50000 Hz: A) RCD_F1 B) RCD_F2.....	43
Figure 17: Mixed-frequency test–laboratory stand for RCD testing.	49
Figure 18: Test results of the AC-type (30 mA) RCD (RCD_AC5) for the mixed-frequency waveforms composed of two components: nominal frequency (50 Hz) and second component with higher frequency level of: A) 500 Hz B) 1000 Hz C) 2000 Hz; MF – mixed-frequency waveform according to Table 10.	51
Figure 19: Test results of the AC-type (30 mA) RCD (RCD_AC2) for the mixed-frequency waveforms composed of two components: nominal frequency (50 Hz) and second component with higher frequency level of: A) 500 Hz B) 1000 Hz C) 2000 Hz; MF – mixed-frequency waveform according to Table 10.	51
Figure 20: Test results of the AC-type (30 mA) RCD (RCD_AC3) for the mixed-frequency waveforms composed of two components: nominal frequency (50 Hz) and second component with higher frequency level of: A) 500 Hz B) 1000 Hz C) 2000 Hz; MF – mixed-frequency waveform according to Table 10.	52
Figure 21: Test results of the A-type (30 mA) RCD (RCD_A1) for the mixed-frequency waveforms composed of two components: nominal frequency (50 Hz) and second component with higher frequency level of: A) 500 Hz B) 1000 Hz C) 2000 Hz; MF – mixed-frequency waveform according to Table 10.	52
Figure 22: Test results of the A-type (30 mA) RCD (RCD_A3) for the mixed-frequency waveforms composed of two components: nominal frequency (50 Hz) and second component with higher frequency level of: A) 500 Hz B) 1000 Hz C) 2000 Hz; MF – mixed-frequency waveform according to Table 10.	53
Figure 23: Test results of the A-type (30 mA) RCD (RCD_A6) for the mixed-frequency waveforms composed of two components: nominal frequency (50 Hz) and second component with higher frequency level of: A) 500 Hz B) 1000 Hz C) 2000 Hz; MF – mixed-frequency waveform according to Table 10.	53
Figure 24: Test results of the B-type (30 mA) RCD (RCD_B1) – (i) with auxiliary supply, (ii) without auxiliary supply – for the mixed-frequency waveforms composed of two components: nominal frequency (50 Hz) and second component with higher frequency level: A) 500 Hz B) 1000 Hz C) 2000 Hz; MF – mixed-frequency waveform according to Table 10.....	55
Figure 25: Test results of the B-type (30 mA) RCD (RCD_B2) – (i) with auxiliary supply, (ii) without auxiliary supply – for the mixed-frequency waveforms composed of two components: nominal frequency (50 Hz) and second component with higher frequency level: A) 500 Hz B) 1000 Hz C) 2000 Hz; MF – mixed-frequency waveform according to Table 10.....	56
Figure 26: Test results of the F-type (30 mA) RCD (RCD_F1) for the mixed-frequency waveforms composed of two components: nominal frequency (50 Hz) and second component with higher frequency level of: A) 500 Hz B) 1000 Hz C) 2000 Hz; MF – mixed-frequency waveform according to Table 10.	57

Figure 27: Test results of the F-type (30 mA) RCD (RCD_F2) for the mixed-frequency waveforms composed of two components: nominal frequency (50 Hz) and second component with higher frequency level of: A) 500 Hz B) 1000 Hz C) 2000 Hz; MF – mixed-frequency waveform according to Table 10.	57
Figure 28: Test results of the AC-type (30 mA) RCD (RCD_AC2) for the following mixed-frequency waveforms composed of three components including 50 Hz, 150 Hz and third higher frequency component of: A) 500 Hz B) 1000 Hz C) 2000 Hz; MF – mixed-frequency waveform according to Table 11.	59
Figure 29: Test results of the AC-type (30 mA) RCD (RCD_AC3) for the following mixed-frequency waveforms composed of three including 50 Hz, 150 Hz and third higher frequency component of: A) 500 Hz B) 1000 Hz C) 2000 Hz; MF – mixed-frequency waveform according to Table 11.....	59
Figure 30: Test results of the AC-type (30 mA) RCD (RCD_AC5) for the following mixed-frequency waveforms composed of three components including 50 Hz, 150 Hz and third higher frequency component of: A) 500 Hz B) 1000 Hz C) 2000 Hz; MF – mixed-frequency waveform according to Table 11.	60
Figure 31: Test results of the A-type (30 mA) RCD (RCD_A1) for the following mixed-frequency waveforms composed of three including 50 Hz, 150 Hz and third higher frequency component of: A) 500 Hz B) 1000 Hz C) 2000 Hz; MF – mixed-frequency waveform according to Table 11.....	60
Figure 32: Test results of the A-type (30 mA) RCD (RCD_A3) for the following mixed-frequency waveforms composed of three components including 50 Hz, 150 Hz and third higher frequency component of: A) 500 Hz B) 1000 Hz C) 2000 Hz; MF – mixed-frequency waveform according to Table 11.	61
Figure 33: Test results of the A-type (30 mA) RCD (RCD_A6) for the following mixed-frequency waveforms composed of three components including 50 Hz, 150 Hz and third higher frequency component of: A) 500 Hz B) 1000 Hz C) 2000 Hz; MF – mixed-frequency waveform according to Table 11.	61
Figure 34: Test results of the B-type (30 mA) RCD (RCD_B1) – (i) with auxiliary supply, (ii) without auxiliary supply – for the following mixed-frequency waveforms composed of three components including 50 Hz, 150 Hz and third higher frequency component of: A) 500 Hz B) 1000 Hz C) 2000 Hz; MF – mixed-frequency waveform according to Table 11.	63
Figure 35: Test results of the B-type (30 mA) RCD (RCD_B2) – (i) with auxiliary supply, (ii) without auxiliary supply – for the following mixed-frequency waveforms composed of three components including 50 Hz, 150 Hz and third higher frequency component of: A) 500 Hz B) 1000 Hz C) 2000 Hz; MF – mixed-frequency waveform according to Table 11.	64
Figure 36: Tripping results of the F-type (30 mA) RCD (RCD_F1) for the following mixed-frequency waveforms composed of three components including 50 Hz, 150 Hz and third higher frequency component of: A) 500 Hz B) 1000 Hz C) 2000 Hz; MF – mixed-frequency waveform according to Table 11.	65
Figure 37: Tripping results of the F-type (30 mA) RCD (RCD_F2) for the following mixed-frequency waveforms composed of three components including 50 Hz, 150 Hz and third higher frequency component of: A) 500 Hz B) 1000 Hz C) 2000 Hz; MF – mixed-frequency waveform according to Table 11.	65



Figure 38: Suddenly applied pure DC residual current test – laboratory stand for RCD testing.	67
Figure 39: Tripping results of the AC-type (30 mA) RCDs for the pure DC residual current (sudden applied): (A) RCD_AC2, (B) RCD_AC5.	68
Figure 40: Tripping results of the A-type (30 mA) RCD for the pure DC residual current (sudden applied): (A) RCD_A1, (B) RCD_A6.	69
Figure 41: Tripping results of the B-type (30 mA) RCD for the pure DC residual current (sudden applied): (A) RCD_B1, (B) RCD_B2.	70
Figure 42: Tripping results of the F-type (30 mA) RCD for the pure DC residual current (sudden applied): (A) RCD_F1, (B) RCD_F2.	71
Figure 43: Slowly rising residual current test–laboratory stand for RCD testing.	73
Figure 44: Tripping results of AC-type (30 mA) RCD (RCD_AC1) for the following slowly rising residual currents: (A) test results from DC (0 Hz) to AC 45 Hz, (B) test results from 50 Hz to 50000 Hz.	75
Figure 45: Tripping results of AC-type (30 mA) RCD (RCD_AC4) for the following slowly rising residual currents: (A) test results from DC (0 Hz) to AC 45 Hz, (B) test results from 50 Hz to 50000 Hz.	76
Figure 46: Tripping results of A-type (30 mA) RCD (RCD_A1) for the following slowly rising residual currents: (A) test results from DC (0 Hz) to AC 45 Hz, (B) test results from 50 Hz to 50000 Hz.	77
Figure 47: Tripping results of A-type (30 mA) RCD (RCD_A3) for the following slowly rising residual currents: (A) test results from DC (0 Hz) to AC 45 Hz, (B) test results from 50 Hz to 50000 Hz.	78
Figure 48: Test results of B-type (30 mA) RCD (RCD_B1) for slowly applied residual current from DC (0 Hz) to AC 45 Hz: (A) test results with AC (230V) auxiliary supply, (B) test results without AC (230V) auxiliary supply.	80
Figure 49: Test results of B-type (30 mA) RCD (RCD_B1) for slowly applied residual current from frequency 50 Hz to 50000 Hz: (A) test results with AC (230V) auxiliary supply, (B) test results without AC (230V) auxiliary supply.	81
Figure 50: Test results of B-type (30 mA) RCD (RCD_B2) for slowly applied residual current from DC (0 Hz) to AC 45 Hz: (A) test results with AC (230V) auxiliary supply, (B) test results without AC (230V) auxiliary supply.	82
Figure 51: Test results of B-type (30 mA) RCD (RCD_B2) for slowly applied residual current from frequency 50 Hz to 50000 Hz: (A) test results with AC (230V) auxiliary supply, (B) test results without AC (230V) auxiliary supply.	83
Figure 52: Test results of F-type (30 mA) RCD (RCD_F1) for the following slowly rising residual currents: (A) test results from DC (0 Hz) to AC 45 Hz, (B) test results from 50 Hz to 50000 Hz.	84
Figure 53: Test results of F-type (30 mA) RCD (RCD_F2) for the following slowly rising residual currents: (A) test results from DC (0 Hz) to AC 45 Hz, (B) test results from 50 Hz to 50000 Hz.	85
Figure 54: Newly proposed RCD invented in the laboratory of Gdansk University of Technology; C.B– circuit- breaker responsible for isolation of source, RL– relay, BR– bridge	

rectifier, VRS– variable resistor (optional), CR– adapter, BY– cell battery for backup, SS– circuit responsible for battery charging surveillance, BB– boost converter circuit, C.T– special current transformer, PE– protective earthing, RCD– residual current device.	88
Figure 55: A lab photo of newly designed RCD.....	89
Figure 56: Oscillogram waveform recorded during testing of newly designed RCD: A – recorded waveform of primary operation (sample of earth fault current) of C.T, B – recorded waveform supplied to the relay (RL) (shows the unidirectional/rectified waveform).....	90
Figure 57: Suddenly applied residual current – Tripping results of newly designed RCD – residual current starting from DC (0 Hz) up to 40000 Hz.	92
Figure 58: Tripping results of the newly designed RCD – for the mixed-frequency waveforms composed of two components: fundamental frequency (50 Hz) and high-frequency component: A) 500 Hz, B) 1000 Hz, C) 2000 Hz; MF – mixed-frequency waveform according to Table 10.	92
Figure 59: Tripping results of the newly designed RCD for the following mixed-frequency waveforms composed of three components including 50 Hz, 150 Hz and third higher frequency component of: A) 500 Hz B) 1000 Hz C) 2000 Hz; MF – mixed-frequency waveform according to Table 11.	93
Figure 60: Test results of newly designed RCD for the following slowly rising residual currents: (A) test results from 0 Hz (DC) to AC 30000 Hz (first category construction), (B) test results from 50 Hz to 40000 Hz (second category construction).	95



REFERENCES

- [1] International Electrotechnical Commission, ‘HD 60364-4-41:2017. Low-Voltage Electrical Installations—Part 4-41: Protection for Safety—Protection Against Electric Shock’, 2017.
- [2] International Electrotechnical Commission (IEC), ‘IEC 61008-1:2010 Residual current operated circuit-breakers without integral overcurrent protection for household and similar uses (RCCBs) - Part 1: General rules’, 2010.
- [3] ABB, ‘Protection against earth faults with Residual Current Devices’, 2015, accessed on 15 April 2024, [Online]. Available: <https://library.e.abb.com/public/9f0e99de3bc740288bc41ab95667f72f/RCD%20Technical%20Guide%20EN.pdf>.
- [4] H. Andrei, P. C. Andrei, L. M. Constantinescu, R. Beloiu, E. Cazacu, and M. Stanculescu, ‘Electrical power systems’, *Power Syst.*, pp. 3–47, 2017, doi: 10.1007/978-3-319-51118-4_1.
- [5] R. Andersson, ‘Electric Power Quality in Low Voltage Grid Office Buildings and Rural Substation’, 2015, accessed on 15 April 2024, [Online]. Available: <http://www.diva-portal.org/smash/get/diva2:818167/FULLTEXT01>
- [6] International Electrotechnical Commission, ‘Protection against electric shock – Common aspects for installation and equipment’, *61010-1* © *Iec2001*, vol. 2003, p. 13, 2003.
- [7] P. Devadas, R. Abeth, S. Singh, A. Siluvairajan, and R. Singh, ‘Study of RCD on Industrial Commercial and Residential Electrical Safety-A Hazard Awareness’, in *IOP Conference Series: Materials Science and Engineering*, India, Sweden and Denmark, 2020. doi: 10.1088/1757-899X/906/1/012018.
- [8] X. Zeng, K. K. Li, and W. L. Chan, ‘Wavelet analysis based protection for high impedance ground fault in supply systems’, in *PowerCon 2002 - International Conference on Power System Technology, Proceedings*, Kunming, China, 2002, pp. 275–279. doi: 10.1109/ICPST.2002.1053548.
- [9] K. K. Li, W. L. Chan, Z. Xiangjun, and Y. Xianggen, ‘Novel methods for high-impedance ground-fault protection in low-voltage supply systems’, *Electr. Power Components Syst.*, vol. 31, no. 12, pp. 1133–1150, 2003, doi: 10.1080/15325000390248774.
- [10] Rheinisch-Westfälische Elektrizitätswerke AG, ‘Schutzschaltung zur Sicherung von Menschen und Tieren gegen Schäden durch Berührung eines spannungsführenden Leiters eines Niederspannungsnetzes’, 552678, 1928.
- [11] G. Biegelmeier, *Wirkungen Des Elektrischen Stroms Auf Menschen Und Nutztiere: Lehrbuch Der Elektropathologie*. Berlin: VDE-Verlag, 1986.
- [12] S. Laxminarayan and J. G. Webster, ‘The bravest biomedical engineer: Dr. gottfried biegelmeier’, *IEEE Eng. Med. Biol.*, vol. 22, no. 1, p. 12, 2003, doi: 10.1109/MEMB.2003.1191443.
- [13] International Electrotechnical Commission (IEC), ‘IEC 61140:2016. Protection against electric shock - Common aspects for installation and equipment’, 2016.
- [14] P. Schnell, ‘Differentialschutzschaltung und Lebens-und Brandgefahren in Dreh-und Wechselstromanlagen. ETZ Bd, 64, 119.’, 1943.
- [15] Ward, P. Demystifying RCDs©. Western Automation: Research & Development, 2011, accessed on 30 April 2024, www.westernautomation.com.
- [16] N. Kumi, B. J. Abiodun, C. Boonthum, and K. Pinsuwan, ‘Study of RCD on Industrial Commercial and Residential Electrical Safety – A Hazard Awareness Study of RCD

- on Industrial Commercial and Residential Electrical Safety – A Hazard Awareness’, 2020, doi: 10.1088/1757-899X/906/1/012018.
- [17] X. Luo, Y. Du, X. H. Wang, and M. L. Chen, ‘Tripping characteristics of residual current devices under nonsinusoidal currents’, *IEEE Trans. Ind. Appl.*, vol. 47, no. 3, pp. 1515–1521, 2011, doi: 10.1109/TIA.2011.2125939.
- [18] S. Czapp, *Residual Current Devices: Selection, Operation, and Testing*. Elsevier – Academic Press, 2022, ISBN 978-0-323-89783-9, doi: 10.1016/C2020-0-02927-0.
- [19] S. Czapp and E. Musiał, *Wyłaczniki ochronne różnicowoprądowe – Część I*, no. 56. Bełchatowie: Centralny Ośrodek Szkolenia i Wydawnictw, Zakład Wydawniczy INPE w Bełchatowie, 2016.
- [20] M. Koprivšek, ‘Development Trend of Residual Current Circuit Breakers’, 2018, accessed on 30 April 2024, [Online]. Available: http://www.etigroup.eu//images/userfiles/en-GB/documents/media/Development_Trend_of_Residual_Current_Circuit_Breakers.pdf.
- [21] S. Czapp, ‘Time-Current Tripping Characteristics of RCDs for Sinusoidal Testing Current’, in *International Conference on Information and Digital Technologies*, Zilina, Slovakia: IEEE, 2021, pp. 38–43. doi: 10.1109/IDT52577.2021.9497574.
- [22] Y. Shopov, S. Filipova-Petrakieva, and B. Boychev, ‘Investigation of residual current devices in high frequencies’, in *10th Electrical Engineering Faculty Conference, BULEF*, Sozopol, Bulgaria: IEEE, 2018, pp. 1–3. doi: 10.1109/BULEF.2018.8646945.
- [23] E. Wu *et al.*, ‘Development of a Range of Modified Multifunctional Residual Current Systems and Their Industrial Implementation’, in *IOP Conference Series: Materials Science and Engineering, 10th-12th November*, Orel, Russian Federation, 2021. doi: 10.1088/1757-899X/1211/1/012020.
- [24] J. Gu and J. Wang, ‘Design of a Type B Residual Current Device for Fault Leakage Current Detection’, *IEEE Ind. Appl. Soc. Annu. Meet.*, pp. 1–6, 2021, doi: 10.1109/IAS48185.2021.9677446.
- [25] L. B. Zhornyak and V. M. Snigirov, *Electromechanical devices of automation. The textbook*. Zaporizhia National Technical University - Zaporizhzhia: ZPNU, 2020, ISBN 978-617-529-295-2.
- [26] A. V. C. Warrington, *Protective relays: their theory and practice Volume one. Springer Science & Business Media.*, Volume one. Springer Science & Business Media, 2012.
- [27] M. T. Glinkowski and J. Esztergalyos, ‘Transient modeling of electromechanical relays’, *IEEE Trans. Power Deliv.*, vol. 11, no. 2, pp. 771–782, 1996.
- [28] X. Zeliang, M. Yingzong, D. Feng, Z. Yue, and M. Anheuser, ‘Type B RCD with a simplified magnetic modulation / demodulation method’, in *IEEE 6th International Power Electronics and Motion Control Conference, 17-20 May*, Wuhan, China: IEEE, 2009, pp. 769–772. doi: 10.1109/IPEMC.2009.5157488.
- [29] S. Czapp, ‘Elimination of the Negative Effect of Earth Fault Current Higher Frequency on Tripping of Residual Current Devices’, vol. 91, no. 3, pp. 85–88, 2009, accessed on 25 April 2024, [Online]. Available: <https://eejournal.ktu.lt/index.php/elt/article/view/10610>
- [30] P. Czaja, ‘Influence of the Design of a Residual Current Device on Its Break Time’, *Energies*, vol. 15, no. 23, 2022, doi: 10.3390/en15239054.
- [31] S. Czapp, ‘The impact of DC earth fault current shape on tripping of residual current devices’, *Elektron. ir Elektrotehnika*, vol. 4, no. 4, pp. 9–12, 2008.
- [32] R. Meisel and R. Georg. ‘Residual-current circuit breaker.’, U.S. Patent no. 9,136,074 B2. 2015, U.S. Patent and Trademark Office.
- [33] H. Hattendorf, ‘VDM, Weichmagnetische Werkstoffe auf Ni-Fe-Basis, Report Nr.

- 27', 2014, accessed on 20 May 2024, [Online]. Available: https://www.vdm-metals.com/fileadmin/user_upload/Downloads/Brochures/VDM_Report_27_Weich_magnetische_Werkstoffe.pdf
- [34] Sonel S.A., 'Operating manual RCD testing adapter', 2023, accessed on 5 May 2024, [Online]. Available: https://cdn.sonel.com/Erp/TWR-1_1J%20insobs%20v1.02%20GB.pdf.
- [35] S. Czapp and J. Guzinski, 'Electric shock hazard in circuits with variable-speed drives', *Bull. Polish Acad. Sci. Tech. Sci.*, vol. 66, no. 3, pp. 361–372, 2018, doi: 10.24425/123443.
- [36] S. Czapp, K. Dobrzynski, J. Klucznik, and Z. Lubosny, 'Low-frequency tripping characteristics of residual current devices', in *17th IEEE International Conference on Environment and Electrical Engineering and 2017 1st IEEE Industrial and Commercial Power Systems Europe (EEEIC / I and CPS Europe)*, Milan, Italy, 2017, pp. 7–10. doi: 10.1109/EEEIC.2017.7977445.
- [37] S. Czapp, 'The effect of earth fault current harmonics on tripping of residual current devices', in *ISNCC 2008: 9th Conference-Seminar, Proceedings of the International School on Nonsinusoidal Currents and Compensation*, Lagow, Poland, 2008, pp. 1–6. doi: 10.1109/ISNCC.2008.4627489.
- [38] S. Czapp, 'The effect of PWM frequency on the effectiveness of protection against electric shock using residual current devices', *Prz. Elektrotechniczny*, vol. 87, no. 1, pp. 24–27, 2011.
- [39] S. Czapp, K. Dobrzynski, J. Klucznik, Z. Lubosny, and R. Kowalak, 'Improving sensitivity of residual current transformers to high frequency earth fault currents', *Arch. Electr. Eng.*, vol. 66, no. 3, pp. 485–494, 2017, doi: 10.1515/AEE-2017-0036.
- [40] S. Czapp and S. Szultka, 'Tripping limitations of residual current devices in photovoltaic installations', in *Proceedings of the 2017 18th International Scientific Conference on Electric Power Engineering (EPE)*, Kouty nad Desnou, Czech Republic: IEEE, 2017, pp. 1–5. doi: 10.1109/EPE.2017.7967273.
- [41] T. Tran-Quoc *et al.*, 'Transformerless Inverters and RCD: What's the Problem?', in *25th European Photovoltaic Solar Energy Conference and Exhibition / 5th World Conference on Photovoltaic Energy Conversion*, Valencia, Spain, 2010, pp. 6–10.
- [42] F. Freschi, 'High-frequency behavior of residual current devices', *IEEE Trans. Power Deliv.*, vol. 27, no. 3, pp. 1629–1635, 2012, doi: 10.1109/TPWRD.2012.2191423.
- [43] International Electrotechnical Commission (IEC), 'IEC 61009-1, Residual current operated circuit-breakers with integral overcurrent protection for household and similar uses (RCBOs)- Part 1: General rules', 2012.
- [44] International Electrotechnical Commission (IEC), 'IEC 60755:2017, General safety requirements for residual current operated protective devices', 2017
- [45] S. Czapp, **H. Tariq**, S. Szultka, A. Szultka, E. Zaitseva, and V. Levashenko, 'Electrical safety in low-voltage DC microgrids with B-type residual current devices', *Eksploat. i Niezawodn.*, vol. 24, no. 2, pp. 346–358, 2022, doi: 10.17531/ein.2022.2.16.
- [46] S. Czapp, **H. Tariq**, and S. Cieslik, 'Behavior of Residual Current Devices at Earth Fault Currents with DC Component', *Sensors*, vol. 22, no. 21, 2022, doi: 10.3390/s22218382.
- [47] S. Czapp and **H. Tariq**, 'Behavior of residual current devices at frequencies up to 50 kHz', *Energies*, vol. 14, no. 6, 2021, doi: 10.3390/en14061785.
- [48] International Electrotechnical Commission (IEC), 'IEC 62423: 2009, Type F and type B residual current operated circuit-breakers with and without integral overcurrent protection for household and similar uses.', 2009.

- [49] P. V. Brennan, 'Residual current device with high immunity to nuisance tripping', *IEE Proceedings, Part G Circuits, Devices Syst.*, vol. 140, no. 2, pp. 140–144, 1993, doi: 10.1049/ip-g-2.1993.0022.
- [50] S. Yang and Y. C. Chau, 'Calibration of Residual Current Device (RCD) Testers', *NCSLI Meas.*, vol. 12, no. 4, pp. 28–37, 2018, doi: 10.1080/19315775.2020.1713028.
- [51] E. Musiał and S. Czapp, 'Wyłączniki ochronne różnicowoprądowe', *Przegląd i charakterystyka współczesnych Konstr.*, vol. 109, pp. 3–44, 2008.
- [52] International Electrotechnical Commission (IEC), 'IEC 60364-5-53: 2015, Selection and erection of electrical equipment – Devices for protection for safety, isolation, switching, control and monitoring', 2015.
- [53] International Electrotechnical Commission (IEC), 'HD 60364-7-701:2007 Low-voltage electrical installations-Part 7-701: Requirements for special installations or locations-Locations containing a bath or shower.', 2007.
- [54] International Electrotechnical Commission (IEC), 'HD 60364-7-710:2012, Low-voltage electrical installations - Part 7-710: Requirements for special installations or locations - Medical locations.', 2012.
- [55] International Electrotechnical Commission (IEC), 'IEC 60364-7-722:2018, Requirements for special installations or locations - Supplies for electric vehicles.', 2018.
- [56] M. Z. Abdullah and R. Ariffin, 'Power quality analysis of residual current device [RCD] nuisance tripping at commercial buildings', *ISIEA 2013 - 2013 IEEE Symp. Ind. Electron. Appl.*, pp. 122–125, 2013, doi: 10.1109/ISIEA.2013.6738980.
- [57] P. Xie, Z. Fang, J. Hu, J. Yang, and G. Zhu, 'Tripping Characteristics of Residual Current Devices under Different Working Conditions', in *2019 IEEE 3rd Conference on Energy Internet and Energy System Integration (EI2)*, Changsha, China: IEEE, 2019, pp. 2765–2769. doi: 10.1109/EI247390.2019.9062090.
- [58] J. Wang, Z. Xie, S. Chen, and X. Li, 'Simulation of Residual Current in Low Voltage DC Systems', in *IEEE 66th Holm Conference on Electrical Contacts (HLM)*, San Antonio, TX, USA: IEEE, 2021, pp. 81–88. doi: 10.1109/HLM51431.2021.9671160.
- [59] M. Mitolo, 'Shock hazard in the presence of protective residual-current devices', *IEEE Trans. Ind. Appl.*, vol. 46, no. 4, pp. 1552–1557, 2010, doi: 10.1109/TIA.2010.2051068.
- [60] S. Yasui, T. Kano, N. Triruttanapiruk, and T. Tsuchida, 'Lightning Surge Overvoltage Protection for Low-Voltage Equipment Placed Outdoors in TT System', *IEEE Trans. Electromagn. Compat.*, vol. 65, no. 3, pp. 831–838, 2023, doi: 10.1109/TEMC.2023.3251311.
- [61] L. K. Wah, 'Foundation Earthing System – Its Application', *Journal of the Institution of Engineers*, Malaysia, vol. 83, no. 1, pp. 7–12, 2023.
- [62] International Electrotechnical Commission (IEC), 60479-1 - Effects of current on human beings and livestock. 2016.
- [63] S. Czapp and **H. Tariq**, 'Układ wyłącznika różnicowoprądowego'. Zgłoszenie patentowe nr P.446907 z dnia 30.11.2023, Patent Office of Republic of Poland.
- [64] H. Mafi, R. Yared, and L. Bentabet, 'Smart Residual Current Circuit Breaker with Overcurrent protection', in *IEEE 2nd International Conference on Renewable Energy and Power Engineering (REPE)*, Toronto, ON, Canada: IEEE, 2019, pp. 6–9. doi: 10.1109/REPE48501.2019.9025151.
- [65] International Electrotechnical Commission (IEC), 'HD 60364-4-42:2011, Low voltage electrical installations - Part 4-42: Protection for safety - Protection against the effects of thermal action', 2013.
- [66] International Electrotechnical Commission (IEC), 'IEC 62606:2013, General

- requirements for arc fault detection devices.’, 2013.
- [67] J. Johnson, A. Meares, and A. Fresquez, (2013). *Series and parallel arc-fault circuit interrupter tests*. (Technical Report), accessed on 10 May 2024, [Online]. Available: <https://doi.org/10.2172/1092992>.
- [68] D. Sweeting, ‘Arcing faults in electrical equipment’, *IEEE Trans. Ind. Appl.*, vol. 47, no. 1, pp. 387–397, 2011, doi: 10.1109/TIA.2010.2091476.
- [69] M. Atharparvez and K. R. Purandare, ‘Series Arc Fault Detection Using Novel Signal Processing Technique’, in *2018 IEEE Holm Conference on Electrical Contacts*, Albuquerque, NM, USA: IEEE, 2018, pp. 335–339. doi: 10.1109/HOLM.2018.8611761.
- [70] C. Vasile, V. D’Orchymont, J. Meunier-Carns, J. F. Rey, and H. Raisigel, ‘Arcing persistency measurement for IEC62606 arc-fault detection device certification’, in *2019 IEEE Symposium on Product Compliance Engineering (SPCE Austin)*, Austin, TX, USA, 2019. doi: 10.1109/SPCE47297.2019.8950836.
- [71] S. Czapp, ‘Application of RCD and AFDD in low-voltage electrical installations for protection against fire’, *Prz. Elektrotechniczny*, vol. 95, no. 11, pp. 12–16, 2019, doi: 10.15199/48.2019.11.04.
- [72] C. E. Restrepo, ‘Arc fault detection and discrimination methods’, in *Electrical Contacts - 2007 Proceedings of the 53rd IEEE Holm Conference on Electrical Contacts*, Pittsburgh, PA, USA, 2007, pp. 115–122. doi: 10.1109/HOLM.2007.4318203.
- [73] P. Czaja, ‘Examination of the impact of design of a residual current protective device on the release frequency range’, in *Progress in Applied Electrical Engineering (PAEE)*, Koscielisko, Poland, 2017, pp. 7–11. doi: 10.1109/PAEE.2017.8009009.
- [74] T. Wieland, M. Aigner, E. Schmutzler, J. Pasker, and L. Fickert, ‘Influences on safety issues for inverter supplied grid structures’, in *Electric Power Quality and Supply Reliability*, Tartu, Estonia, 2012, pp. 101–106. doi: 10.1109/PQ.2012.6256211.
- [75] Y. Han, C. Ding, and X. Shou, ‘Design & implementation of an A-type residual current circuit breaker IC’, in *IEEE International Symposium on Industrial Electronics*, Hangzhou, China, 2012, pp. 280–285. doi: 10.1109/ISIE.2012.6237098.
- [76] Y. Wang, K. Li, C. Liu, Z. Guo, F. Niu, and X. Zhang, ‘Study on modeling and simulation of AC/DC sensitive residual current transformer’, in *1st International Conference on Electric Power Equipment - Switching Technology, ICEPE2011 - Proceedings*, Xi’an, China: IEEE, 2011, pp. 692–696. doi: 10.1109/ICEPE-ST.2011.6122913.
- [77] A. M. Featherstone and A. S. Sastrosubroto, ‘An examination of RCD performance during system disturbances (and other relays)’, in *IEE Colloquium on Safeguarding Industrial Plant During Power System Disturbances*, London, UK, 1989, pp. 3–8.
- [78] International Electrotechnical Commission (IEC), ‘IEC60364-5-52: 2009 Low voltage electrical installation-Part 5-52: Selection and erection of electrical equipment-Wiring systems’, 2009.
- [79] A. Baggini, *Handbook of Power Quality*. Wiley eBooks, 2008. ISBN 978-0-470-75424-5, doi: 10.1002/9780470754245.
- [80] T. Gruhn, J. Glenney, and M. Savostianik, ‘Type B Ground-Fault Protection on Adjustable Frequency Drives’, *IEEE Trans. Ind. Appl.*, vol. 54, no. 1, pp. 934–939, 2018, doi: 10.1109/TIA.2017.2758342.
- [81] R. K. Panda and J. Veeramalla, ‘Behavior modeling of a type B RCD’, in *1st IEEE International Conference on Power Electronics, Intelligent Control and Energy Systems (ICPEICES)*, Delhi, India: IEEE, 2017, pp. 1–6. doi: 10.1109/ICPEICES.2016.7853100.

- [82] **H. Tariq** and S. Czapp, ‘Tripping of F-type RCDs for High-Frequency Residual Currents’, in *International Conference on Information and Digital Technologies (IDT)*, Zilina, Slovakia: IEEE, 2021, pp. 277–281. doi: 10.1109/IDT52577.2021.9497590.
- [83] **H. Tariq**, S. Czapp, and V. Levashenko, ‘RCDs Tripping in the Range from DC to AC 50 kHz for Slowly Rising Residual Current’, in *International Conference on Information and Digital Technologies (IDT)*, Zilina, Slovakia: IEEE, 2023, pp. 207–212. doi: 10.1109/IDT59031.2023.10194402.
- [84] T. M. H. Slangen, B. R. F. Lustenhouwer, V. Čuk, and J. F. G. Cobben, ‘The effects of high-frequency residual currents on the operation of residual current devices’, *Renew. Energy Power Qual. J.*, vol. 19, no. 19, pp. 67–72, 2021, doi: 10.24084/repqj19.216.
- [85] W. C. Leal, ‘A control system for battery current sharing in DC microgrids with DC bus voltage restoration’, in *14th Brazilian Power Electronics Conference, COBEP*, Juiz de Fora, Brazil, 2017, pp. 1–6. doi: 10.1109/COBEP.2017.8257423.
- [86] M. Parol, ‘Mikrosieci - przyszłościowe struktury sieci dystrybucyjnych’, *Przegląd Elektrotechniczny*, vol. 1, no. 8, pp. 3–7, 2016, doi: 10.15199/48.2016.08.01.