

# Quality Testing of Welded Joints of Wind Towers with Advanced Ultrasonic Techniques – a Case Study

## Badanie jakości złączy spawanych wież wiatrowych zaawansowanymi technikami ultradźwiękowymi – studium przypadku

**Abstract:** The application of advanced quality control tests for welds is essential for enhancing competitiveness in the welded construction industry. The global focus on obtaining energy from alternative sources is leading to the increased production of wind towers. Improving the method of conducting inspections is necessary as wind tower structures are subject to 100% quality control of welded joints. The article presents the comparison of tests involving a model of an actual wind tower structure and ultrasonic methods, i.e. the conventional UT technique and the advanced and automated PAUT technique. An important element of the tests was the development of the instrumentation enabling the more accurate recording of the process.

**Key words:** wind towers, non-destructive tests, ultrasonic test, UT, PAUT, Phased Array, non-conformities/welding defects

**Streszczenie:** Zastosowanie zaawansowanych badań kontroli jakości spoin jest istotne dla podniesienia konkurencyjności w branży konstrukcji spawanych. Globalne ukierunkowanie pozyskiwania energii z alternatywnych źródeł prowadzi do zwiększenia produkcji wież wiatrowych. Konstrukcje te podlegają 100 % kontroli jakości złączy spawanych i dlatego istotne jest doskonalenie sposobu przeprowadzania kontroli. W artykule przedstawiono porównanie badań przeprowadzonych na modelu rzeczywistej konstrukcji wieży wiatrowej metodami ultradźwiękowymi: konwencjonalną techniką UT oraz techniką zaawansowaną i zautomatyzowaną PAUT. Ważnym elementem badań było opracowanie oprzyrządowania umożliwiającego doskonalszą rejestrację procesu.

**Słowa kluczowe:** wieże wiatrowe, badania nieniszczące, badanie ultradźwiękowe, UT, PAUT, niezgodności/wady spawalnicze

### 1. Introduction

The objective of the article is to present selected conclusions concerned with the testing of the quality of welded joints obtained during the fabrication of wind towers, illustrated with an example of one of the experiments performed within a project implemented at Baltic Operator Sp. z o. o. (BO) and co-financed by the National Centre for Research and Development<sup>1</sup>. The project aimed to improve the production process in terms of testing the quality of welded joints and took into account the specific nature of all BO product groups, including wind towers. The project involved the identification of problems for each product group and the development of prototype solutions and

procedures aimed at implementing and commercialising the UT/PA system for large-sized steel structures. The UT/PA system features mobile testing stations and a stationary analytical station designed for advanced ultrasonic tests involving the use of the PAUT (Phased Array) technique along with a network platform for the digital recording, analysis, sharing and monitoring of welded joint-related quality diagnostics processes at BO.

In cases of wind towers, the specific nature of the product is subject to continuous tests and globally performed design-related experiments, with particular emphasis given to safe production and operation. Although the second decade of the 21st century sees design/structural aspects perfected as the global compendium of knowledge, safety aspects remain crucial (including the specific nature of non-destructive test objects, i.e., among other things, wind towers). Both aspects are closely related and, for this reason, must be addressed to properly justify conclusions drawn from exemplary experiments. All problems are „hot” as they are located at the heart of activities related to global climate and energy policies, requiring a holistic

<sup>1</sup> R&D project entitled Development and Implementation of a Model Expert System based on an Advanced UT/Phased-Array (UT/PA) for the Monitoring of the Production Process and the Diagnostics of Large-Sized Off-Shore and On-Shore Welded Structures for the Maritime Industry Implemented in the Years 2020-2023 (in collaboration with the AGH University of Science and Technology and the Institute of Fundamental Technological Research of the Polish Academy of Sciences) and with the Period of Implementation by 2028.

mgr inż. Alicja Bera, dr inż. Ryszard Pyszko – Gdańsk University of Technology, Faculty of Mechanical Engineering and Ship Technology, Poland

mgr inż. Zbigniew Górski, dr Jolanta Sala, inż. Arkadiusz Szczurek – Baltic Operator Sp. z o.o.

Corresponding Author: alibera@pg.edu.pl

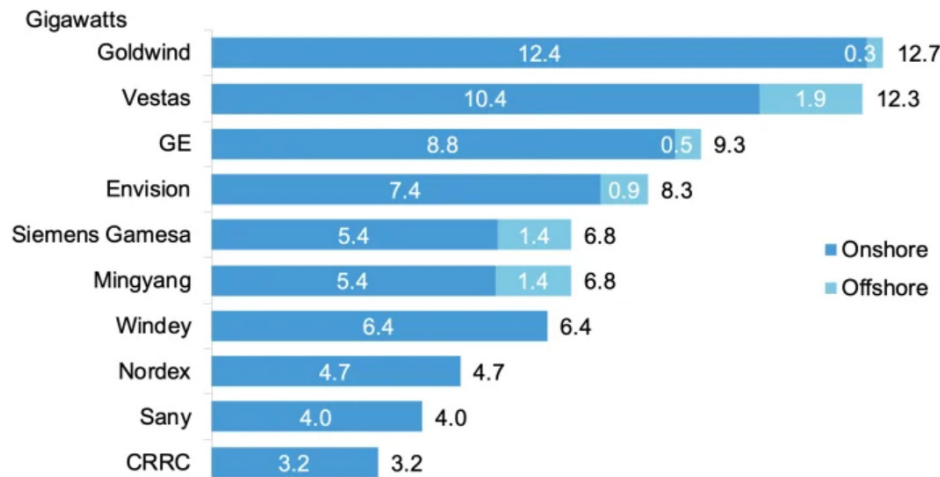

Fig. 1. World's 10 largest producers of wind farms in 2022 (source: BNEF) [1]

approach from scientific, business and political perspectives. The article constitutes only a small, yet important fragment of current socio-economic activity. Undoubtedly, quality-related requirements for welded joints are connected primarily with materials, welding processes and operating conditions. In turn, the level of the ultrasonic testing of welds may be subject to an agreement between the manufacturer and the ordering party, yet it results from related normative regulations. The article highlights one of the methods enabling the 3D imaging of test welds using two methods, i.e. the conventional UT technique and the advanced PAUT technique, aimed at analysing and comparing results.

### 2. Production of wind towers in Poland

Baltic Operator (BO) is Poland's leading producer of wind towers and one of the leading producers of wind towers in the world. The purchasers of wind towers manufactured by BO are global wind farm producers including Vestas, Siemens, GE, Nordex, etc. (Fig. 1).

Offshore wind power generation development plans assume a sharp increase in power generated from onshore wind turbine systems (up to 14 GW by 2030) [2]. Equally important are plans related to the installation of offshore wind turbines in the Polish economic zone in the Baltic Sea, assumed to amount to approximately 5.9 GW by 2030. [2]. Seeing prospects for an increase in the number of orders, BO is carrying out developmental works aimed at ensuring larger deliveries of wind towers [3, 4]. Meeting the above-named requirements involves, among other things, an increase in the length of welds to be tested in tower structures, which are to be higher and have a larger diameter than previously. The solution to the problem will involve an increase in the number of employees examining welds or the development and implementation of superior weld diagnostics.

### 3. Typical structure of on-shore wind towers

Wind towers can have various structures, e.g. tubular or lattice ones, or be made of concrete blocks. The research work focuses on tubular tower structures made of metallic materials and whose structural aspects are addressed

in numerous publications, including [5–10]. Typical tubular structures of onshore wind towers consist of sections connected using bolted flanges. Each section consists of several rolls of metal plates and two flanges [11]. The length of the section and the weight of the tower result from the technological capabilities of a given company including the production hall, manufacturing equipment, transport routes, load-bearing capacity of the quay and the depth of the water area at the quay. Wind towers having a height restricted within the range of 70 m to 90 m usually consist of three sections having a height of 18 m to 36 m and a weight of 30 t to 40 t. The shape of the tower is usually conical, with a diameter ( $\varnothing$ ) of the upper section of approx. 2500 mm and a thickness ( $g_{min}$ ) of 15 mm. The lower section can have  $\varnothing = 5000$  mm and  $g_{max} = 50$  mm. Figure 2 shows the basic correlations between the heights and thicknesses of individual sections and rolls of a wind tower. The thickness of

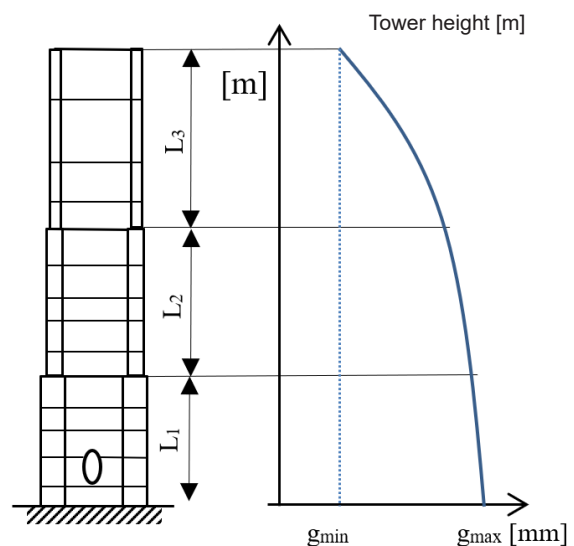

- $L_3$  – length of the third section with n-rolls
- $L_2$  – length of the second section with n-rolls
- $L_1$  – length of the first section with n-rolls
- $L_1 < L_2 < L_3$  – usually
- $\varnothing$  – frame
- $g_{min}$  – minimum roll thickness
- $g_{max}$  – maximum roll thickness
- Section flange thicknesses are not presented

Fig. 2. Height and thickness of individual sections and rolls of the wind tower

the rolls changes in a stepped manner, i.e. from the largest thicknesses at the base of the tower to smaller thicknesses at its top. BO's human and infrastructural capital enables the production of larger wind towers, having a larger number of sections with larger diameters of up to several meters and roll thicknesses of up to approximately  $g_{\max} = 120$  mm [12].

Depending on the design, a single section consists of several to between ten and twenty rolls and two flanges. Figure 3 presents the structure of the lower section of the wind tower with the frame and the designations of welds in relation to their identification in qualitative tests.

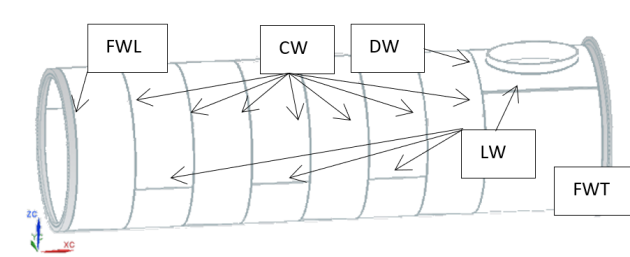

Welds:

- CW (circumferential butt welds)
- LW (longitudinal butt welds)
- FWL (circumferential butt welds between the L-type flange and the roll)
- FWT (circumferential butt welds between the T-type flange and the roll)
- DW (circumferential weld between the frame and the roll)

Fig. 3. Typical wind tower section

Each weld is made in accordance with a related welding procedure specification (WPS). The dominant weld length is that of CW, afterwards FWL and FWT, LW and, depending on the section, DW. Figure 3 presents an L-type flange used on the left side of the tower section, and a T-type flange used on the right side of the tower section. In spite of the fact that most of the welds are butt welds, they are divided into separate sub-groups, due to the necessity of identification and various testing methods.

#### 4. Improved testing of welds in wind tower structures

The typical structure of the steel section of a wind tower contains a total of approximately 150 m of welded joints, the specific nature of which has been characterised in numerous scientific publications, including [13–17]. Intensive analyses were focused on failures/breakdowns related to wind towers, including [18–22] and the development of appropriate safety standards and rules, among other things,

by the National Renewable Energy Laboratory (NREL) and the National Wind Technology Centre (NWTC) in the USA as well as in the European Union and Poland. The regulations regarding the quality of welds in offshore and onshore structures require surface tests including 100 % visual tests (VT) of external imperfections [23] and up to 100 % inspection volumetric method-based tests including ultrasonic testing (UT) respectively. In industrial practice, the most commonly used technique is conventional ultrasonic testing (UT) and/or other inspection methods, as required by BO's customers. The company unit responsible for weld quality control faces at least two major challenges (in accordance with the diagram presented in Figure 4):

1. The first challenge includes testing, detection, assessment and the selection of welding imperfections for repairs.
2. The second challenge involves the inspection of welds in wind tower sections at an appropriate time after welding (aimed to minimise the effect on the entire prefabrication process).

The NDT process is tasked with the identification of welding imperfections and their classification in accordance with the PN-EN ISO-6520 standard [24].

#### 5. Weld quality control based on UT and PAUT techniques under industrial conditions

The experimental comparative tests involved, among other things, one of the test welds made on the actual wind tower structure under industrial conditions. The weld tests involved a section having a diameter of 5 m and a thickness of 30.8 mm. The length of the test weld amounted to 15.71 m. The tests were performed using the conventional UT technique and the advanced PAUT technique [29] (terminology – pp. 51-52). The preparation and welding processes were performed in accordance with a selected welding procedure specification (WPS). For experimental purposes, the Authors selected a welding procedure which led to the formation of weld imperfections. The comparison of the test results was performed in accordance with the flowchart presented in Figure 5. The completion of the welding works and an appropriate post-weld and pre-NDT technological break were followed by the performance of visual tests (VT). The test result did not reveal any surface imperfections. The subsequent step involved the performance of tests involving the use of volumetric techniques. The performance of the aforesaid tests was followed by the preparation of NOK reports indicating the locations of we-

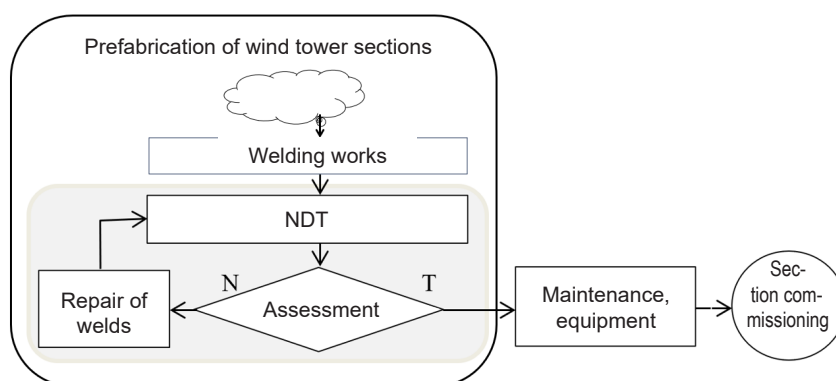

Fig. 4. Schematic diagram of the performance of non-destructive tests (NDT) in the prefabrication of wind tower sections

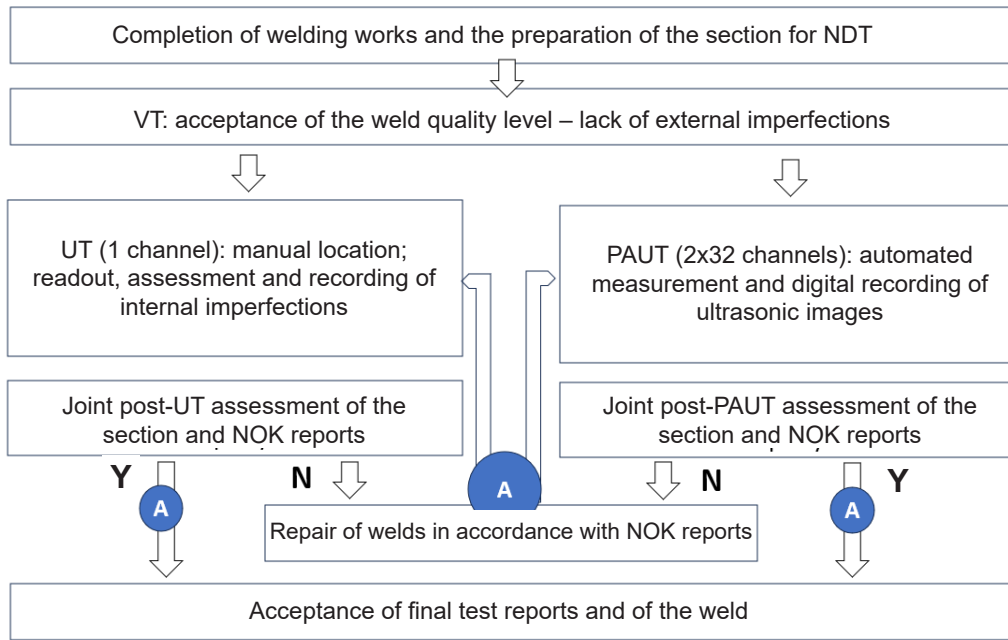

Fig. 5. Flowchart of weld test sub-processes

lding imperfections. The reports were used to compare the results of tests performed using the two techniques.

Three areas indicated with the letter „A” in the flowchart depict precise analyses, where two areas were concerned with comparisons of weld segments with positive indications (Y) as regards the quality of welding works. In turn, one key area was concerned with the comparative analysis of weld segments with negative indications (N), obtained using one or both ultrasonic techniques (NOK reports). The analysis included comparisons of diagnostic results before the repair and, in cases of discrepancies, also after the repair of imperfections.

5.1. Conventional ultrasonic tests (UT)

The performance of the ultrasonic tests (UT) involved the systematic recording (on a dedicated sheet) and the description (on the test specimen) of areas containing identified imperfections. The ultrasonic tests (UT) were performed in accordance with the PN-EN ISO 17640:2019 [25] (testing procedure) PN-EN ISO 23279:2017-11 (characteristics

of discontinuities ) [26] and PN-EN ISO 11666: 2018 [27] (acceptance criteria) standards. The tests involved the use of a single transmitting-receiving transducer with a single ultrasonic beam (1 channel). The test was preceded by the calibration of the transducer (Fig. 6).

The subsequent stage included the performance of ultrasonic tests involving the test weld; the test results were recorded in the NOK report. Ultrasonic tests tend to be difficult as the operator must simultaneously observe readouts from the measurement instrument, manually guide the transducer in an appropriate manner and continuously assess the location and classification of the signal, i.e. information about an imperfection (NOK report). The assessment not only involves the presence of an imperfection but also its size and distance from other imperfections, leading either to the acceptance of weld quality or to referring the weld for repair. The operator performing ultrasonic tests must also control manipulators and, before the test, prepare and apply the couplant onto the area near the weld.

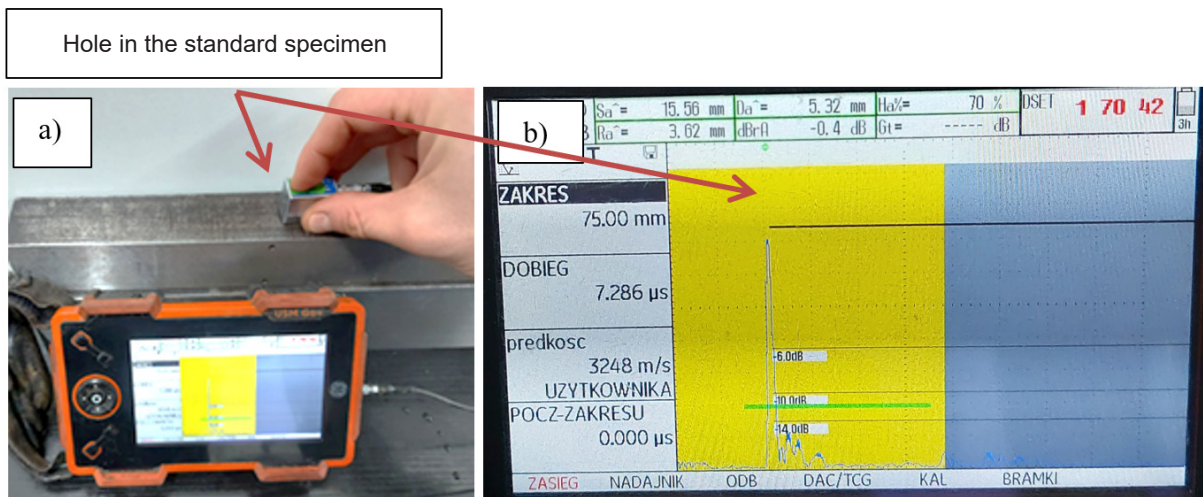

Fig. 6. Pre-test preparation: a) calibration of the UT transducer before the measurement and b) defectoscope screen

## 5.2. Advanced phased array ultrasonic tests (PAUT)

The PAUT technique, planned to be implemented within the project, is regarded as an advanced NDT method [28] [29] [30]. The PAUT technique-based assessment of the welded joint requires two stages. The first stage involves digitally and automatically recordable test imaging, whereas the second stage includes analysing the conformity of imaging results with related acceptance criteria.

The phased array ultrasonic tests (PAUT) were performed in accordance with the PN-EN ISO13588 [31] (testing procedure), PN-EN ISO 18563 (inspection, characteristics and verification of measurement equipment [32] and PN-EN ISO 19285:2017 [33] (acceptance criteria) standards. The tests were performed using an OmniScan X3 defectoscope provided with two 32-element transducers (2×32 channels). In accordance with the PN-EN ISO 13588:2019 standard [31], phased array ultrasonic tests of welds should be preceded by verification involving the use of reference specimens (Fig. 7).

The next stage involved the performance of the PAUT-based scanning of welds with a previously determined distance between the transducers and the weld symmetry

plane (see Figure 9). Before the test, it was necessary to design the appropriate arrangement of the transducers in relation to the weld axis (also referred to as scan plans) (see Fig. 8). The foregoing is essential because of the necessity of controlling the propagation of ultrasonic beams in the material and the appropriate imaging of the reflection and refraction of waves (resulting from the geometry of a given test element). The scan plans (presented in Figure 8 b) and c)) were developed using the BeamTool9 software.

Figure 9 presents an exemplary imperfection recorded during one of the experimental tests. The selected measurement technique enabled the analysis of A-scan-type signals in the form of S-scan, B-scan and C-scan. The imperfection presented in the scan is the lack of penetration (i.e. imperfection from group 4).

Table 1 presents the extension of the symbols used to identify individual measurement parameters and methods of identifying individual imperfections.

Test automation in the UT/PA system (for the CW, FWL and FWT circumferential welds) consists in the continuous and controlled rotation of the sections on manipulators with a constant and fixed position of the two transducers in relation to the circumferential weld symmetry plane

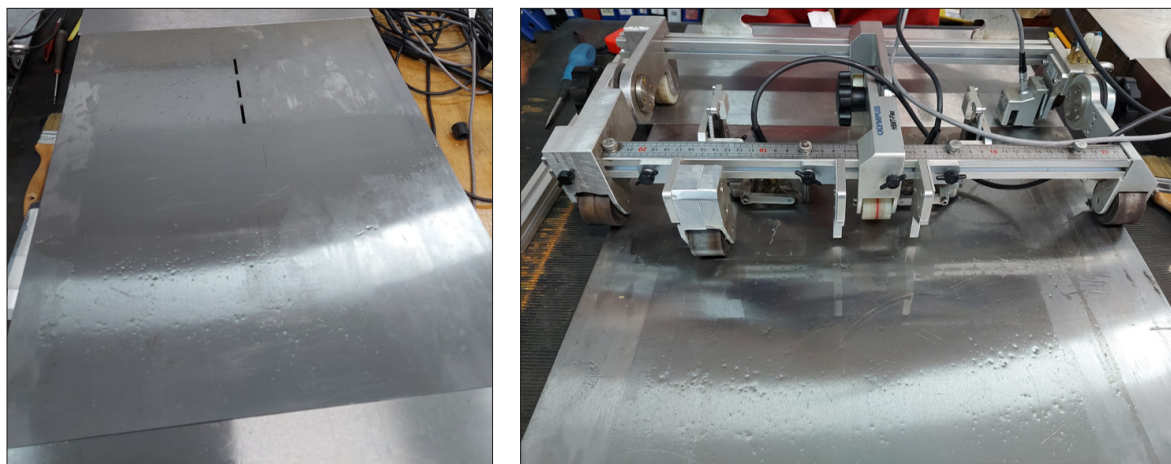

**Fig. 7.** Reference specimen with artificially made grooves of various sizes and locations and the scanner with transducers during the pre-PAUT calibration of the transducer

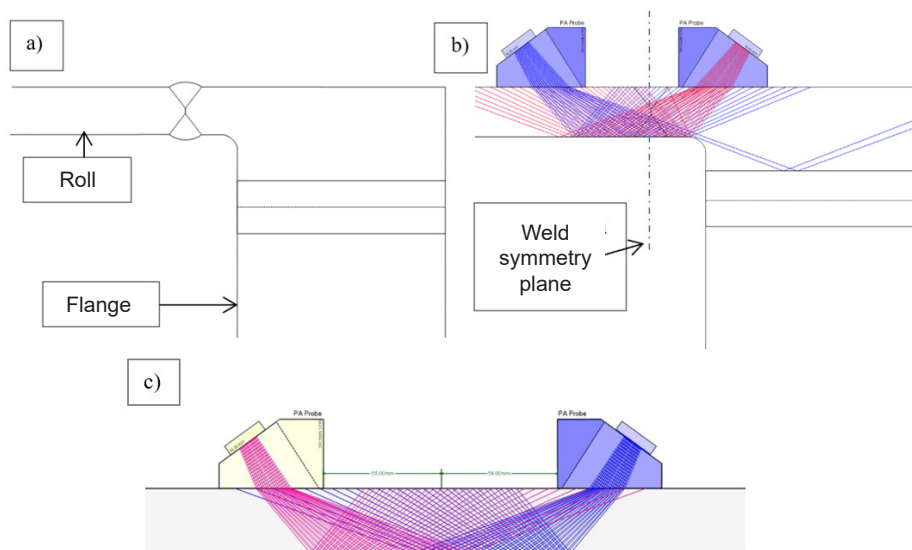

**Fig. 8.** Position of transducers: a) circumferential weld in the flange area, b) simulated phased array ultrasonic test of the circumferential weld near the flange (scan plan) and c) simulated phased array ultrasonic test of the circumferential (butt) weld (scan plan)

Indication 2 Type: Lack Of Root Fusion Rejected

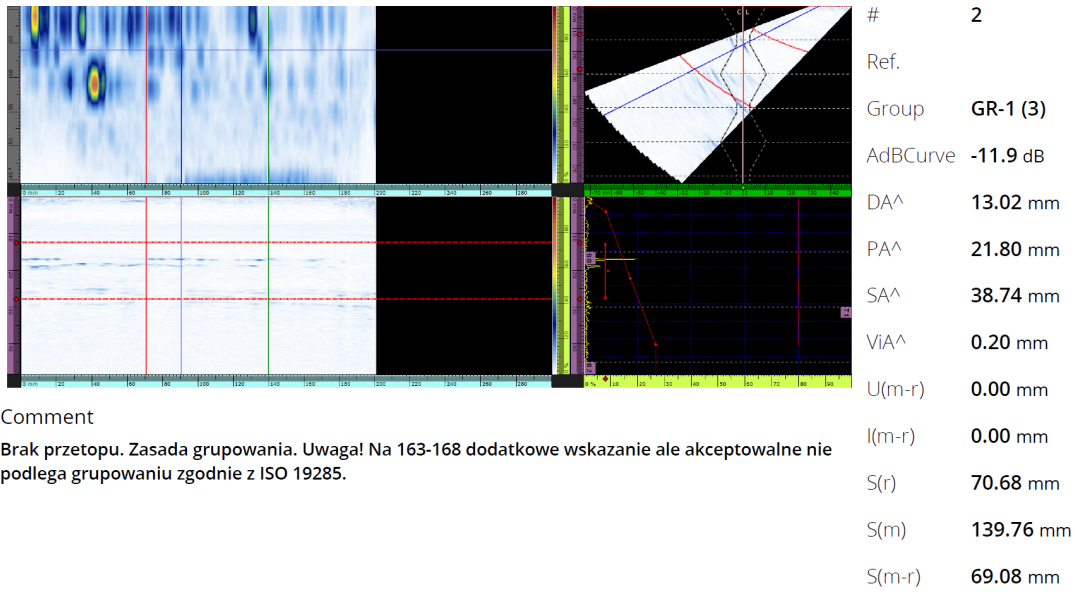

Fig. 9. Exemplary scans of the welding imperfection (A-scan, S-Scan, B-Scan and C-scan)

Table 1. Parameters of the imperfection identified by the UT/PA system in the NOK report

AdBCrve	1.9 dB	Difference between the amplitude of the signal detected in gate A and the corresponding amplitude of the selected dimensioning curve
DA^	13.02 mm	Deposition depth
PA^	21.80 mm	Distance on the surface between the front of the wave (or the transducer) and the detection indicated in gate A
SA^	38.74 mm	Path of the sound from the point of entry to the indication detected in gate A
ViA^	0.20 mm	Location in relation to the weld
S(r)	70.68 mm	The beginning of the imperfection in relation to the zero point
S(m)	139.76 mm	The end of the imperfection in relation to the zero point
S(m-r)	69.08 mm	Length of the imperfection
U(m-r)	0,0 mm	Height of the imperfection

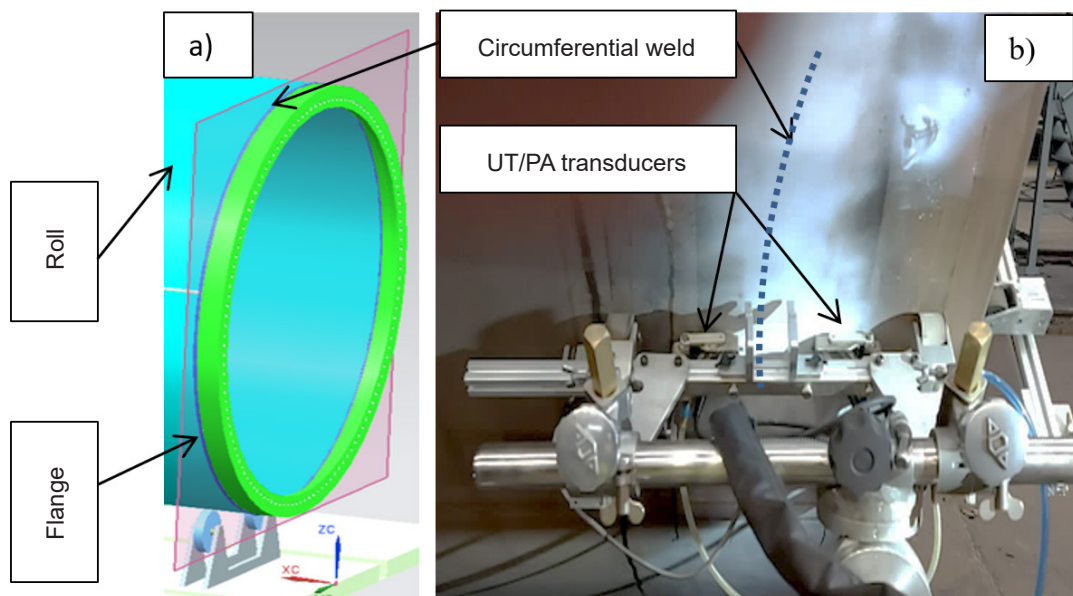
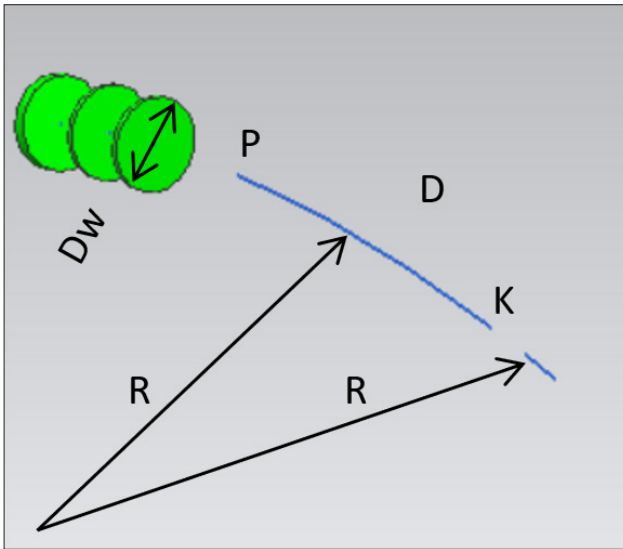

Fig. 10. View of a) circumferential test weld and b) locations of PAUT transducers

(Fig. 10). The process is accompanied by the automatic recording of encoder indications, concerning the location of the transducers around the circumference of the section in relation to the selected test starting point. The mounting of the scanner with the transducers enables significantly faster measurement registration, synchronised with a manipulator travel rate of up to 100 mm/s. The application of the above-presented solutions enables the performance of measurements by one specialist certified to level 1 [28, p. 7] and their subsequent analysis by a qualified specialist certified to at least level 2. [28, p. 7].

The tests of welds were accompanied by the constant supply of water (instead of chemical couplant solutions) under the transducers (through automatic coupling).



R – external roll radius  
 P – beginning of imperfection recording  
 K – end of imperfection recording  
 D – imperfection length – PK arc  
 Dw –  $\varnothing$  of visualisation ring

Fig. 11. Presentation of test results

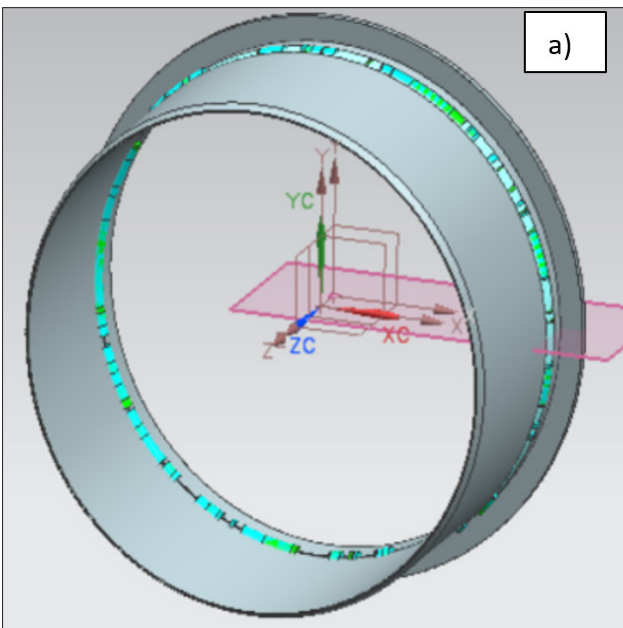

## 6. Comparison of test results

The PAUT technique provides significantly more data for analysis than those obtainable using the UT technique. For this reason, the direct comparison of both testing methods could raise doubts. To compare the results obtained using both techniques, it was necessary to assume a simplification involving the comparison of the locations of imperfections, i.e. their initial and final positions, which were subsequently plotted on the outer surface of the test section in the weld symmetry plane.

An attempt aimed at synchronising and comparing the test results was made in order to validate the UT/PA system, yet, primarily, to verify the scanning method and visuali-

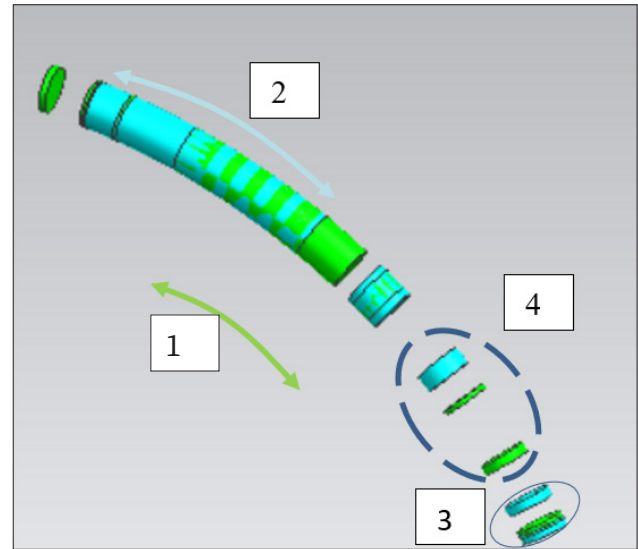

Exemplary locations of detected imperfections:

1. Overlapping imperfections
2. Varying beginning and/or end
3. Closely located imperfections
4. Other locations

Bright green colour: PAUT technique; Bright blue colour: UT technique

Fig. 12. Locations of the imperfections detected using the PAUT and UT techniques

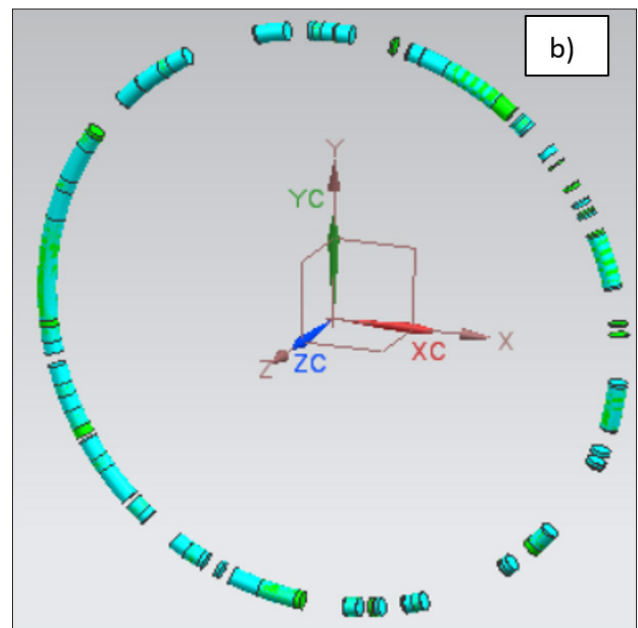

Fig. 13. Test results: a) plotted on the visualisation of the actual structure and b) presented after blanking the structure

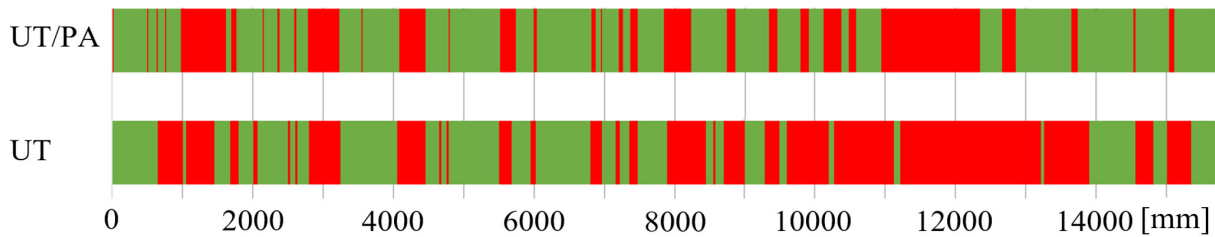

Fig. 14. Comparison of imperfections, presented in relation to the weld length

sation useful for improving and optimising the process of production. The principle of displaying results concerning locations of detected indications is presented in Figure 11.

The test results based on NOK reports were visualised through the common location of detected imperfections in a digital 3D CAD image of the weld. The reference surface was the outer surface of the roll on which the transducers were guided (Fig. 10). The locations of detected imperfections overlapped to a significant extent. It was possible to observe differences as regards the assessment of the beginning and end of imperfection locations. The so-called close locations probably resulted from transducer guiding accuracy. It was also possible to observe areas where testing techniques indicated different locations (Fig. 12).

The recorded data included the beginning and the end of the imperfection in relation to the conventional UT technique. The PAUT technique enabled the recording of the above-named parameters and other parameters including, among other things, the depth of the imperfection in relation to the reference surface. Because of the size of the element and recorded indications, the detected imperfections were marked as a cylinder having a diameter of 150 mm. The bright green colour indicates the test results obtained by means of the PAUT technique, whereas the bright blue colour indicates the test results obtained using the UT technique (Fig. 12, 13).

Figure 14 presents (in a supplementary manner) the locations of the areas where welding imperfections were located (marked red). The areas free from imperfections are marked green.

## 7. Analysis of test results

The test results obtained using both techniques were subjected to analyses and led to the formulation of the following conclusions:

- The total length of imperfections/defects recorded using the PAUT technique amounted to 5135 mm, whereas that recorded using the conventional UT technique amounted to 8335 mm. The UT technique-based measurement indicated joint defectiveness greater by 38 % (in relation to the same welded joint). The above-presented conclusion provides a direction for optimising the wind tower section prefabrication process (based on time saved as a result of eliminating excess repairs – see Fig. 4).
- The difference in the total length of recorded imperfections/defects resulted primarily from the accuracy of the location and the method of interpreting recorded results (including the combining of imperfections/defects). In the conventional UT examination, the same imperfection was interpreted as another one, close to the previous imperfection. An important advantage of the

precise longitudinal localisation of PAUT tests involving the use of the OmniScan X3 defectoscope was the encoder, whose resolution amounted to 12.00 steps/impulses per 1 mm (where the scanning resolution amounted to 1.00 mm). As can be seen, conventional ultrasonic tests are significantly less precise as regards the quality of measurements in respect of their locations.

- The acceptance levels for welding imperfections/defects concerning wind tower structures are restrictive. In cases of conventional UT techniques, specialists tend to qualify excess repairs. Owing to the stable digital recording of PAUT results, the inspector can more easily qualify non-conformities for repair and, at the same time, check later if test results were assessed correctly.
- Unlike the conventional UT technique, the PAUT method makes it possible to examine a significantly greater length of welds by one person and offers the possibility of reviewing and evaluating test results after recording. The processes of measurement and recording can be clearly separated from the subsequent analysis and interpretation of test results.
- The possibility of recording test results and archiving them in the UT/PA diagnostics system enables the re-interpretation of the results by another specialist, greatly contributing to the increased credibility of tests and analyses.
- The PAUT technique is characterised by great self-study potential as regards NDT personnel, welding engineers, welding practitioners, welders and artificial intelligence/machine learning (aimed to improve the UT/PA systems).
- The UT technique enabled the detection of imperfections from groups 1 through 4, i.e. cracks, cavities, solid inclusions, incomplete fusion and lack of penetration. The PAUT technique enabled the detection of the same imperfections, yet it offered the superior recording and interpretation of imperfections from groups 1 and 2, i.e. voids and cracks.
- The UT/PA mobile test stations were focused mainly on improving the ultrasonic recording of the quality of welded joints, and, in particular, on significantly improving the distribution of work performed by the personnel conducting tests, among other things, in accordance with [28]. The automation and robotisation-based solutions make it possible to consider aspects of easing the qualification and certification of level 1 operators as regards the UT/PA technique.

Obviously, the above-presented example of one of the validation and implementation experiments in the project was not the only one as such experiments should always accompany the implementation of a new NDT technique [30, p. 60]. Depending on the types of welds, the results of comparative analyses varied, yet in relation to the longest welded joints (i.e. CW and FW types), the results were the



same (and this study disregarded the specific nature A, B, S and C-scans) (Fig. 9).

*The above-presented tests were performed within the project entitled Development and Implementation of a Model Expert System based on an Advanced UT/Phased-Array (UT/PA) for the Monitoring of the Production Process and the Diagnostics of Large-Sized Off-Shore and On-Shore Welded Structures for the Maritime Industry Implemented in the Years 2020-2023 (in collaboration with the AGH University of Science and Technology and the Institute of Fundamental Technological Research of the Polish Academy of Sciences) and with the Period of Implementation by 2028.*

## REFERENCES

- [1] Pająk P.: Najwięksi producenci elektrowni wiatrowych. Zmiana na pozycji lidera, Gramwzielone.pl, 2023.
- [2] Rada Ministrów Rzeczypospolitej Polskiej and Ministerstwo Klimatu i Środowiska, Polityka Energetyczna Polski do 2040 r., Dziennik Urzędowy Monitor Polski, no. 22, 2021.
- [3] Bera A., Gniba R., Sala J.: Identyfikacja szans rozwoju polskiej morskiej energetyki wiatrowej, Gdańsk 2020.
- [4] Bera A., Górski Z., Pyszko R., Sala J.: Identyfikacja procesów produkcji wież wiatrowych, Gdańsk 2021.
- [5] Bazeos N., Hatzigeorgiou G.D., Hondros I.D., Karamaneas H., Karabalis D.L., Beskos D.E.: Static, seismic and stability analyses of a prototype wind turbine steel tower. *Engineering Structures*, 2002, vol. 24, no. 8, pp. 1015-1025, DOI: 10.1016/S0141-0296(02)00021-4.
- [6] Lavassas I., Nikolaidis G., Zervas P., Efthymiou E., Doudoumis I.N., Baniotopoulos C.C.: Analysis and design of the prototype of a steel 1-MW wind turbine tower. *Engineering Structures*, 2003, vol. 25, no. 8, pp. 1097-1106, DOI: 10.1016/S0141-0296(03)00059-2.
- [7] Veljkovic M., Heistermann C. i in.: High-strength tower in steel for wind turbines. Contract No RFSR-CT-2006-00031, Brussel 2006.
- [8] Nussbaumer A., Borges L., Davaine L.: *Fatigue Design of Steel and Composite Structures*. Ernst & Sohn, 2011.
- [9] Bzdawka K.: Structural analysis of a wind turbine tower-steel tubular towers of heights: 76.15 m and 105.0 m. MSc Thesis, Poznan 2011.
- [10] Lee K.S., Bang H.: A study on the prediction of lateral buckling load for wind turbine tower structures. *International Journal of Precision Engineering and Manufacturing*, 2013, vol. 13, pp. 1829-1836, DOI: 10.1007/s12541-012-0240-y.
- [11] Thanasoulas I.D., Koulatsou K.G., Gantes C.J.: Nonlinear Numerical Simulation of Bolted Ring Flanges in Wind Turbine Towers. *Proceedings of the IASS-SLTE 2014 Symposium. Shells, Membranes and Spatial Structures: Footprints*, September 2014.
- [12] Baltic Operator, Zwijarki do blachy grubej. Data dostępu: 12.04.2024 <https://gdanskshipyard.pl/products/wieze-wiatrowe/>.
- [13] Cicero S., Lacalle R., Cicero R.: Estimation of the maximum allowable lack of penetration defects in circumferential butt welds of structural tubular towers. *Engineering Structures*, 2009, vol. 31, no. 9, pp. 2123-2131, DOI: 10.1016/j.engstruct.2009.03.013.
- [14] Lotsberg I.: Stress concentrations due to misalignment at butt welds in plated structures and at girth welds in tubulars. *International Journal of Fatigue*, 2009, vol. 31, no. 8-9, pp. 1337-1345, DOI: 10.1016/j.ijfatigue.2009.03.005.
- [15] Jiang W., Fan Q., Gong J.: Optimization of welding joint between tower and bottom flange based on residual stress considerations in a wind turbine. *Energy*, 2010, vol. 35, pp. 461-467, DOI: 10.1016/j.energy.2009.10.012.
- [16] Veljkovic M., Feldmann M., Naumes J., Pak D., Rebelo C., Da Silva L.S.: Friction connection in tubular towers for a wind turbine. *Stahlbau*, 2010, vol. 79, no. 9, pp. 660-668, DOI: 10.1002/stab.201001365.
- [17] Stavridou N., Efthymiou E., Baniotopoulos C.C.: Welded connections of wind turbine towers under fatigue loading: Finite element analysis and comparative study. *American Journal of Engineering and Applied Sciences*, 2015, vol. 8, no. 4, pp. 489-503, DOI: 10.3844/ajeassp.2015.489.503.
- [18] Khatri D.: *Structural Failures of Wind Towers and Dynamic Analysis Procedures*. Los Angeles 2009.
- [19] Chou J.S., Tu W.T.: Failure analysis and risk management of a collapsed large wind turbine tower. *Engineering Failure Analysis*, 2011, vol. 18, no. 1, pp. 295-313, DOI: 10.1016/j.engfailanal.2010.09.008.
- [20] Lacalle R., Cicero S., Álvarez J.A., Cicero R., Madrazo V.: On the analysis of the causes of cracking in a wind tower. *Engineering Failure Analysis*, 2011, vol. 18, no. 7, pp. 1698-1710, DOI: 10.1016/j.engfailanal.2011.02.012.
- [21] Raftery M.: The dark side of „green”: Wind turbine accidents, injuries and fatalities raise serious safety concerns. *East County Magazine*, 2012.
- [22] Ragheb M.: *Safety of wind systems*. Wind Power Systems Course material, 2013.
- [23] Kloskowski L., Pałubicki S., Kukiełka K.: *Badania nieniszczące złączy spawanych na przykładzie wybranych elementów konstrukcyjnych siłowni wiatrowych*. *Autobusy: technika, eksploatacja, systemy transportowe*, 2015, t. 16, no. 6, pp. 113-122.
- [24] Lewandowski M., Rozbicki J., Smach H., Karwat P., Szczurek A., Sala J., Bera A.: Modelowe rozwiązania skanerów UTPA do badań spawów dla wież wiatrowych, sekcji płaskich oraz konstrukcji wielkogabarytowych on-shore/off-shore. *Badania Nieniszczące i Diagnostyka*, 2022, t. 1-4, pp. 89-92, DOI: 10.26357/BNID.2022.010.
- [25] PN-EN ISO 17640:2019-01: 2019. *Badania nieniszczące spoin - Badania ultradźwiękowe - Techniki, poziomy badania i ocena*.
- [26] PN-EN ISO 23279:2017-11: 2017. *Badania nieniszczące spoin - Badania ultradźwiękowe - Charakterystyka nieciągłości w spoinach*.
- [27] PN-EN ISO 11666:2018-04: 2018. *Badania nieniszczące spoin - Badania ultradźwiękowe - Poziomy akceptacji*.
- [28] PRS: 2021. *Przepisy - Publikacja 80/P - Badania nieniszczące*.
- [29] Śliwowski M.: *Podstawy zawansowanej technologii phased-array*. Podstawy i zastosowania, Warszawa 2021.
- [30] Śliwowski M.: *Zautomatyzowane badania systemami PA + TOFD - wdrażanie i zastosowania*. *Badania Nieniszczące i Diagnostyka*, 2022, t. 1-4, pp. 50-62. doi: 10.26357/BNID.2022.007.
- [31] PN-EN ISO 13588:2019-04: 2019. *Badania nieniszczące spoin - Badanie ultradźwiękowe - Stosowanie zautomatyzowanej techniki głowicy mozaikowej*.
- [32] PN-EN ISO 18563-2:2017-11: 2017. *Badania nieniszczące - Charakteryzowanie i weryfikacja aparatury ultradźwiękowej z głowicami wieloprzetwornikowymi - Część 2: Głowice*.
- [33] PN-EN ISO 19285:2017-11: 2017. *Badania nieniszczące spoin - Badania ultradźwiękowe techniką głowicy mozaikowej (PAUT) - Kryteria akceptacji*.