

# MODELING OF FLOW PHENOMENA ASSOCIATED WITH POLYMER INJECTION INTO A MOLD

WŁODZIMIERZ PRZYBYLSKI AND STEFAN DZIONK

*Department of Manufacturing Engineering and Automation,  
Mechanical Engineering Faculty, Gdansk University of Technology,  
Narutowicza 11/12, 80-952 Gdansk, Poland  
sdzionk@due.mech.pg.gda.pl*

(Received 11 May 2002; revised manuscript received 10 September 2002)

**Abstract:** The process of plastic injection, although of extensive industrial use, is still relatively poorly researched. In building a finite element model for the injection process, the emphasis was laid on the modeling of phenomena occurring at the polymer-mold interface. With this purpose in mind, the mesh was refined in the vicinity of mold walls. The influence of the air present in the mold during the injection process was also taken into account. As the outcome of solving the problem so formulated, a model of polymer behavior at the mold wall interface has been obtained. Numerical simulations were carried out with the aid of a FIDAP flow-modeling program, and their results were partly verified by experimental means.

**Keywords:** injection molding, surface layer, plastic

## 1. Introduction

We can define a surface defect as a defect an unintentional technological effect, situated in the surface layer of an object. There are defects visible to the naked eye, as well as little defects not so visible. In these times of great requirements regarding quality of produced parts, very much depends on the quality of the surface layer.

The surface layer is the layer of a material limited externally by the actual surface of an article containing this surface layer, and internally – by physical, and sometimes chemical features in relation to the remaining material inside of object. The surface layer of a multimolecular plastic part is constituted during its processing through factors connected with material conversion, with tool manufacturing and with processing conditions [1]. Factors connected with material conversion are first of all the properties and structure of the polymer and its fillings, flexibilizer, *etc.*, and relations between them. Factors connected with tool manufacturing include material composition of the mold, its manufacturing and the state of its surface layers. Factors connected with conditions of processing are mostly the kind and intensity of physical loads present during processing, during cementing or hardening, during cooling of an

object after its formation in the tool mold, as well as during and after extraction from the mold. While estimating the above-mentioned properties one should also take into account the time which elapsed from the moment of part production. The process of forming the surface layer begins at the start of the mold-filling process. Small chains of polymer in contact with the surface of the mold adsorb to it linking only in definite places of chain [1].

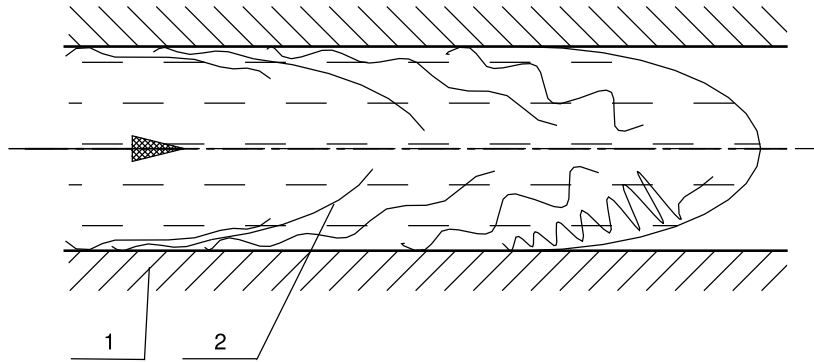

**Figure 1.** Orientation of chains of material during flow: 1 – mold wall, 2 – consecutive phases of extension and alignment of polymer chains

In motionless materials' chains of particles are found in the state of disordered entanglements (with the exception of liquid crystal polymers (LCP)).

While flowing, materials become oriented in small segments, which process is schematically represented in Figure 1. Such orientation is considered in relation to local lengthening of liquid material elements, the narrowing of the flow channel or the extension of materials while in the plastic state (*e.g.* in bottle blowing). Another phenomenon creating orientations of material elements is shear of adjoining layers of liquid materials, *e.g.* in a stream of material with a steep profile of speed [2]. These occurrences cause a highly directional layer to be formed on surface of the article, and its directionality decreases toward the core (or axis of the flowing material). As a result of the Brownian motion of particles, these orientations vanish very quickly, that is to say an unstressing process follows. For polymers, the relaxation time is several seconds (depending mostly on the temperature of the material). The material adjacent to a cold mold wall undergoes quick loss of heat during inflow, resulting in the freezing of oriented polymer chains. Thicknesses of directional layers strongly depend on the temperature of the material, the temperatures of the mold local rates of shear, the rate of stream lengthening, and the speed of material solidifying [3, 4]. Orientation of chains results in anisotropic properties in the direction of orientation: greater strength stiffness, smaller extension at tearing, smaller thermal expansibility and manufacturing contraction. This also causes tensional stresses to arise in the oriented layer, which further change the above-mentioned properties. After the material has solidified, the relaxation process is dependent on the temperature of article storage. When the element is used at room temperature, the unstressing process takes place so slowly that one can say that the above-mentioned properties do not change. When the

article is used at increased temperatures, one should take into account an accelerated occurrence of unstressing, and with this, changes in properties.

Another occurrence having influence on the quality of an article's surface is an effect known as the gramophone-record effect. It results from the fact that the free surface of flow of a material at the point of junction with the mold's wall creates an effect of waving, which is schematically represented in Figure 2. This effect is discussed in literature [5, 6].

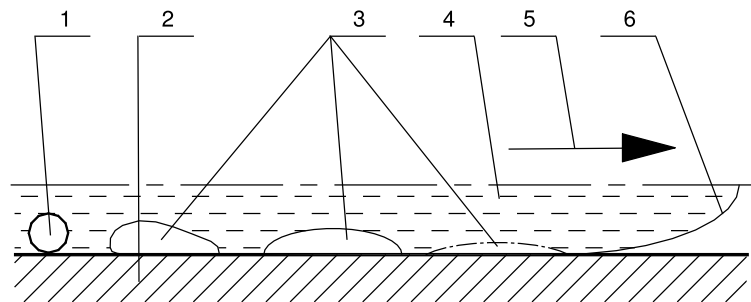
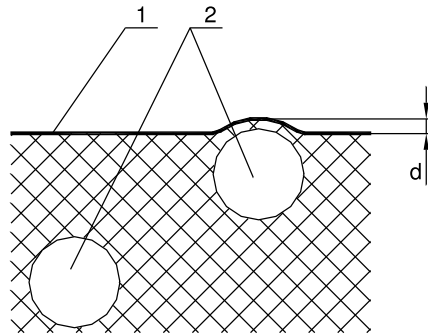

**Figure 2.** A scheme of flaw creation in the surface layer of flowing plastic: 1 – a blister of air, 2 – mold wall, 3 – consecutive phases of creation of a blister of air, 4 – liquid material, 5 – direction of flow of the liquid material, 6 – leading surface of the flowing material

Waving of the surface causes the closing of volumes (3) of air on the border of the surface of mold and plastic.

The flowing material pushes these micro volumes, changing their shape until they separate from the surface of the mold, thus creating a blister of air (1). Material in the mold flows until it fills the volume of the mold, which causes the inequalities of surface brought about by this effect to assemble in a zone at the end of the filled volume. Considering that the gramophone-record effect is caused by a cold mold being filled with a cold material, we can accept that the size of depressions occurring as a result of flow depends mostly on the viscosity of the material. The depressions can be minimized by proper choice of processing parameters, mostly by fixing the temperature of the material at a level which minimizes this effect. A problem arises, when addition of material occurs at a lower temperature, because higher temperatures of injection are unobtainable due to dye decomposition, or other fillings entering the composition of the material. In such causes, one should design the mold so that material finishes its flow in an area where defects of surface are admissible. One should also remember that the material is flowing into the mold under pressure of about 10MPa. On depressurization following the opening of the mold, the material is unloaded and residual stresses are relaxed. The entrapped air, being compressible, remains under pressure. This imprisoned air then introduces tensions in the material surrounding the blister.

These additional tensions cause deformations of the surface of a component, *e.g.* convex inequalities of surface, which are schematically represented in Figure 3. It may also happen that a blister near the surface will explode, causing destruction of the layer of material dividing it from the surface of the article. This is a source of additional defects of surface.



**Figure 3.** Influence of blisters of air on inequalities of surface of an article:  
1 – the surface of a material, 2 – blisters imprisoned in the surface layer,  
d – deformation of the surface of an article

## 2. Numerical model – theoretical basis

The constitutive equation for generalized Newtonian liquids takes the form [7, 8]:

$$\underline{T} = 2\eta(\dot{\gamma}, T)\underline{D}, \quad (1)$$

where  $\underline{T}$  is the stress tensor,  $\eta$  – the viscosity function,  $\dot{\gamma}$  – generalized shear speed,  $T$  – temperature,  $\underline{D}$  – the speed of deformation tensor.

The speed of deformation tensor is defined as:

$$\underline{D} = (\nabla \underline{v} + \nabla \underline{v}^T), \quad (2)$$

where  $\underline{D}$  is the speed of deformation tensor,  $\nabla \underline{v}$  – velocity field gradient,  $\nabla \underline{v}^T$  – transposed velocity field gradient.

Generalized shear speed is defined as:

$$\dot{\gamma} = (2\underline{D} : \underline{D})^{\frac{1}{2}}, \quad (3)$$

where  $\dot{\gamma}$  is generalized shear speed,  $\underline{D}$  – the speed of deformation tensor.

In general:

$$\eta(\dot{\gamma}, T) = F(\dot{\gamma}) \cdot H(T), \quad (4)$$

where  $\eta(\dot{\gamma}, T)$  is the viscosity function,  $F(\dot{\gamma})$  – the function of shear speed,  $H(T)$  – the function of medium temperature.

For a Newtonian liquid:

$$F(\dot{\gamma}) = \text{const.} \quad (5)$$

For a Birda-Carreau-Yasudy liquid:

$$\frac{\eta - \eta_{\infty}}{\eta_0 - \eta_{\infty}} = [1 + (\lambda \dot{\gamma})^a]^{(n-1)/2}, \quad (6)$$

where  $\eta_0$  is the viscosity constant (viscosity at zero shear speed),  $\eta_{\infty}$  – viscosity at shear speed approaching infinity,  $\lambda$  – the time constant,  $n$  – the flow exponent,  $a$  – a dimensionless parameter of transition from the Newtonian to the exponential viscosity model.

In practice, a simplified version of the above equation is often used in the original Birda-Carreau model: with the parameter  $a = 2$ , assuming that  $\eta_\infty = 0$  for molten polymers, one obtains the equation in the form:

$$F(\dot{\gamma}) = \eta_0(1 + \lambda^2 \dot{\gamma}^2)^{(n-1)/2}. \quad (7)$$

The fundamental empirical relation is the Oswald-de Waele exponential model:

$$\eta(\dot{\gamma}) = m\dot{\gamma}^{n-1}, \quad (8)$$

where  $m$  is the consistency factor [ $\text{N} \cdot \text{s}^n / \text{m}^2$ ],  $n$  – the dimensionless flow exponent.

### 3. Computer simulation

The process of injection was simulated using the FIDAP 8 program, utilizing the classical mechanics of liquids. The simulation was executed using the computers at the TASK Computer Centre in Gdansk (Poland). The modeled flow was transient, laminar, Newtonian, incompressible and two-phase (plastic-air) with gravity effects.

The finite element grid was finely meshed in the vicinity of mold walls, as shown in Figure 4. The initial phase of injection is presented in Figure 5. Cavities forming at the plastic-mold interface are marked with an “a”. Figure 6 shows the results of the simulation of the injection process at the plastic-mold interface. In phase (a), waviness

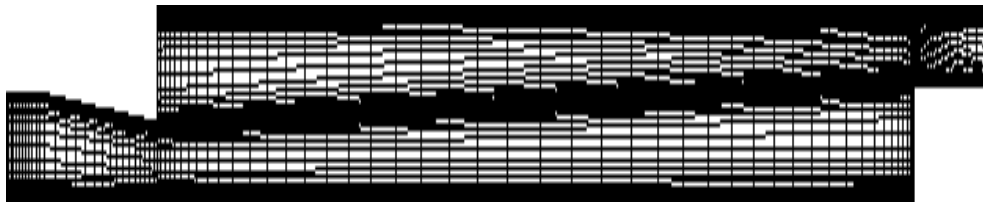

Figure 4. Schema of a mold showing the finite element grind

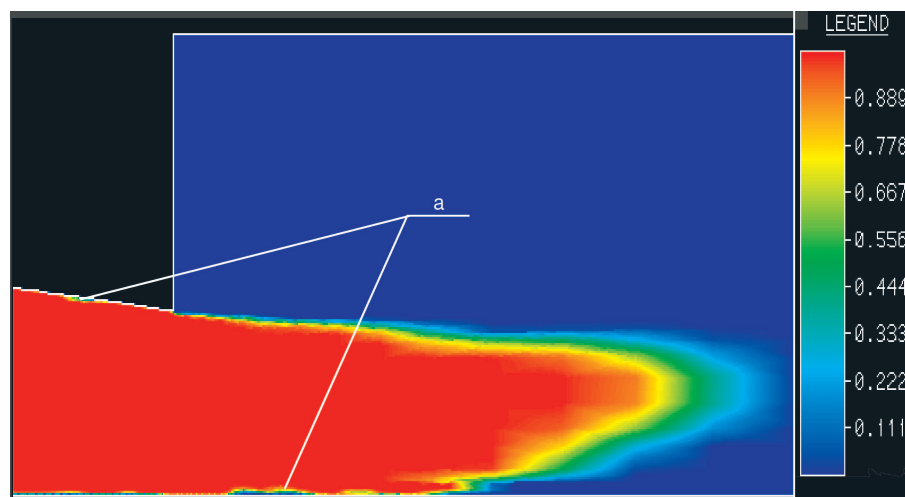
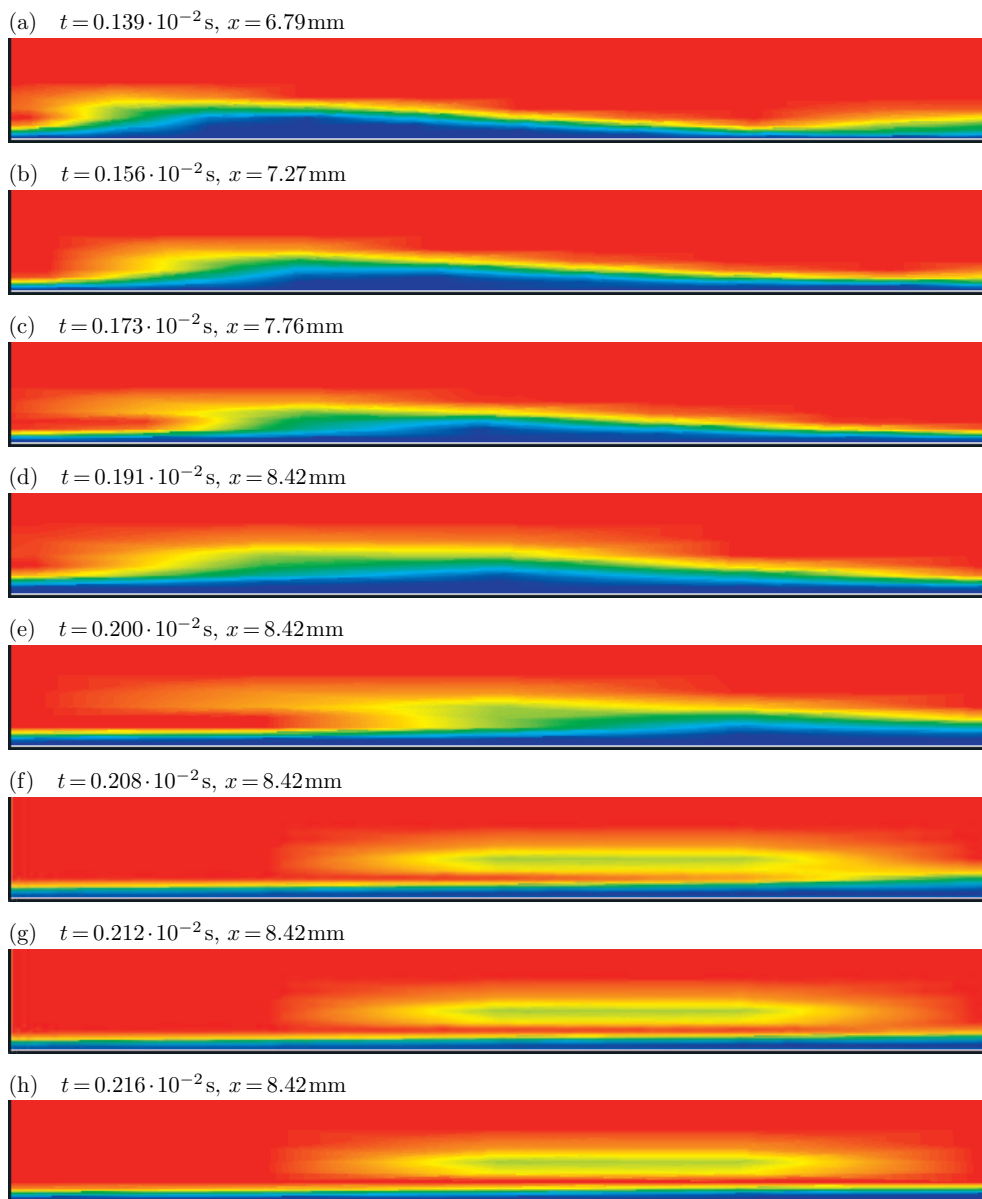

Figure 5. Computer simulation of injection at the moment  $t = 0.124 \cdot 10^{-2} \text{s}$ , red – plastic, blue – air, black – mold wall, a – developing cavities



**Figure 6.** Numerical simulation of changes taking place at the mold-plastic interface during injection: (a)–(h) consecutive phrases of injection,  $t$  – time from the start of injection,  $x$  – position of the right edge of pictured area, red – plastic, blue – air, black – mold wall

develops at the leading surface of the flow adjacent to the mold wall, which in the following phases of the injection process, shown as (b)–(h) in Figure 6, is subjected to deformation until a closed air blister is formed as discussed above. These results could be interpreted taking into account the mesh size, as indicated in Figure 7.

The blister shown in Figure 7 is elongated, which is a side effect of mesh scaling. The possibility of using a finer mesh in subsequent simulations is currently being considered.

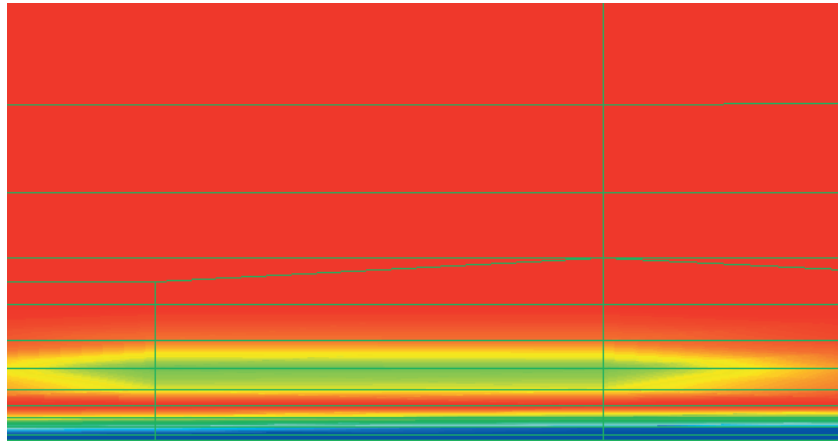

Figure 7. View of blister overlaid with finite element mesh

#### 4. Experimental research

The investigations were carried out on polyamide PA6 samples. The material used was produced by STILON SA – GORZÓW WIELKOPOLSKI under commercial name TECHNYL S-27 BL (material code 10002, lot 1571/A030B1). Samples were executed on an electronically controlled injection molding machine with the following parameters: temperatures in each plastifying zone  $T_1 = 205^\circ\text{C}$ ,  $T_2 = 215^\circ\text{C}$ ,  $T_3 = 245^\circ\text{C}$ ,  $T_d = 240^\circ\text{C}$ , pressure of injection 6 MPa, hold-down pressure 5 MPa, temperature of the mold  $40^\circ\text{C}$ . Shape of samples: rectangular prism approximately  $4 \times 10 \times 79\text{mm}$  with rounded corners of approximately 2 mm radius. Throat of nozzle was placed centrally at the 10 mm edge.

For roughness measurements [9], we have used a HOMMEL TESTER T500, class 1 according to DIN4772. The profile graph and the graphs bearing fraction of surface and roughness were executed using TURBO DATAWIN software.

#### 5. Results of research and their evaluation

On obtained samples, we have observed the characteristic pattern of surface. These structures are partly visible to the naked eye and their formation is not connected with any defect of the mold.

The surface textures were examined with a profile meter. Their characteristic feature is a regular wave of profile graph. An example profile graph is introduced in Figure 8, where direction of flow of material corresponds to the direction of the x axis. We have ascertained that for different flow conditions the key parameters of waviness (amplitude and wavelength) vary significantly. Inequalities follow an extensive concavity, which one can qualify as caving in of material. This pattern is characteristic of all the samples under investigation.

Subsequently, inequalities develop in the wave pattern, as shown in Figure 9, with the formation of extensive concavities (a) or plateaus (c) in the surface of the material at points of wave irregularity. The resulting profile is diagrammed in Figure 10. The pit-like cavities (1)–(4) alternating with plateau regions (3) are clearly

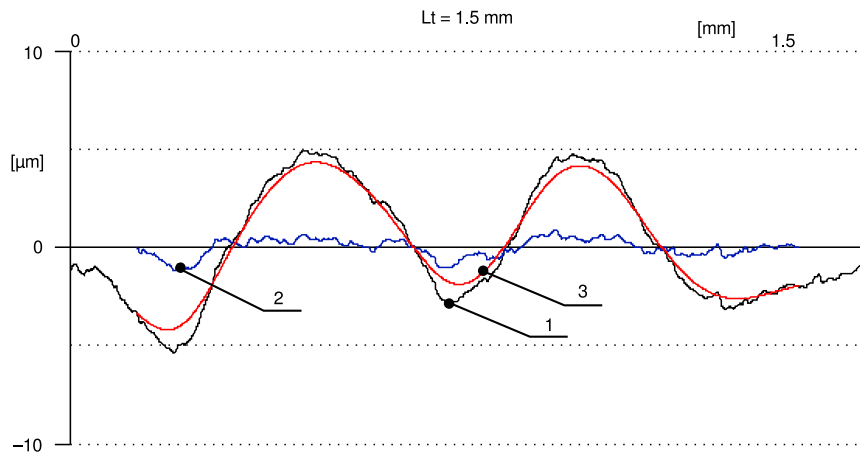

**Figure 8.** Waviness of sample surface: 1 – real profile, 2 – filtered profile of roughness, 3 – waviness of surface

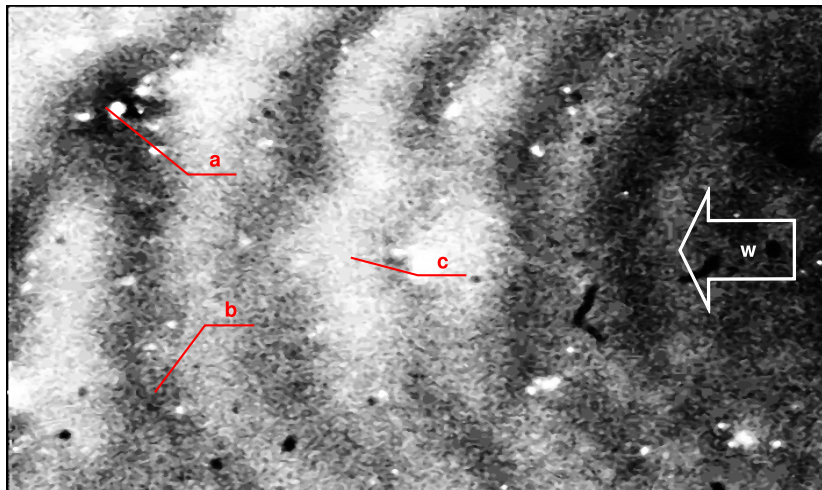

**Figure 9.** Photograph showing the breaking-up pattern of a surface: **a** – caving of a surface, **b** – wave trough, **c** – crest of wave, **w** – direction of flow of the material, magnification 250 times

visible in the graph. The pits have a tendency to close up, resulting in blister formation similar to the process seen in the numerical simulation.

This pattern occurs most often in the region where flow in the mold comes to an end.

Research is currently being continued on the influence of injection conditions on the quality of the surface layer in plastic parts.

## 6. Conclusion

On the basis of the theoretical study and experimental tests performed, the following conclusions can be formulated:

- During production of plastic elements by the method of injection molding, and in particular, when high accuracy is required, one should take under



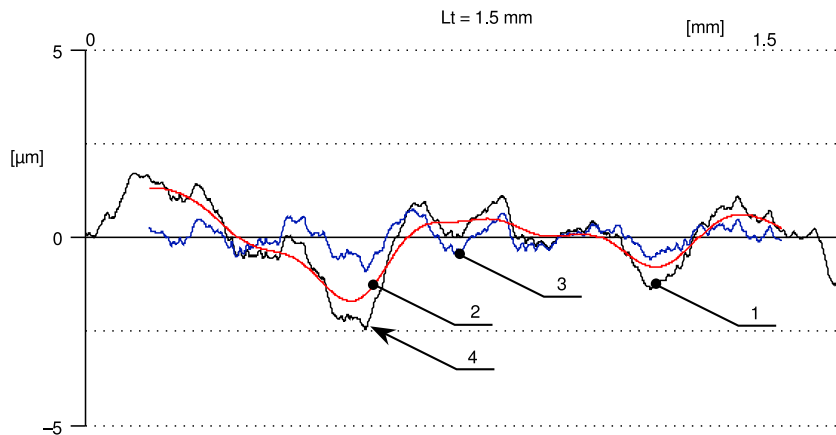

**Figure 10.** Waviness of the surface of a sample: 1 – real profile, 2 – waviness of the surface, 3 – filtered profile of roughness, 4 – caving of the surface

consideration, that the obtained surface will not be the exact image of the mold surface.

- During injection effects occur in the mold-wall zone that affect the properties of the surface layer (*e.g.* formation of defects, geometrical structure of surface) of the produced parts; these effects are present both in the experimental runs and in the numerical simulations.
- However, we can obtain the desired properties of the surface layer of plastic components by changing the technological parameters connected with manufacturing process (*e.g.* the speed of injection), enabling the reduction of flow-induced surface irregularities.
- Similar defects occur during injection molding of ceramics (*e.g.*  $\text{Al}_2\text{O}_3$ ) [6], and thus the results may have a direct impact on the quality of ceramic products.
- The idea could also be useful with respect to stabilization of injection-molded plastics.

### Acknowledgements

Calculations were carried out at the TASK Computer Center in Gdansk (Poland).

### References

- [1] Sikora R 1997 *Inżynieria Materiałowa* **4** 160 (in Polish)
- [2] Joshi Y M, Lele A K and Mashelkar R A 2000 *J. Non-Newton. Fluid Mech.* **94** (2-3) 135
- [3] Guo X, Isajev A I and Guo L 1999 *Polym. Eng. Sci.* **39** (10) 2096
- [4] Guo X, Isajev A I and Guo L 1999 *Polym. Eng. Sci.* **39** (11) 2132
- [5] Tredoux L, Satoh I and Kurosaki Y 1999 *Polym. Eng. Sci.* **39** (11) 2233
- [6] Zhang T, Evans J R G and Bevis M J 1999 *J. Ceram. Soc.* **19** 411
- [7] Bociąga E 2000 *Advances in Manufacturing Science and Technology* **24** (3) 89
- [8] Kulikov O L and Hornung K 2001 *J. Non-Newton. Fluid Mech.* **98** (2-3) 107
- [9] Gadelmawla E S, Koura M M, Maksoud T M, Elewa I M and Soliman H H 2002 *J. Mater. Process. Tech.* **123** (1) 133

