

# PHYSICAL AND NUMERICAL MODELLING OF HEAT-FLOW PROCESSES IN TANGENTIALLY PULVERIZED FUEL-FIRED BOILER

JACEK BARAŃSKI<sup>1</sup>, JAN STĄSIEK<sup>1</sup>  
AND WŁODZIMIERZ BLASIAK<sup>2</sup>

<sup>1</sup>*Gdansk University of Technology, Department of Heat Technology,  
Narutowicza 11/12, 80-952 Gdansk, Poland  
jbaransk@pg.gda.pl*

<sup>2</sup>*Royal Institute of Technology (KTH),  
Division of Energy and Furnace Technology,  
100 44 Stockholm, Sweden*

(Received 24 January 2003; revised manuscript received 13 March 2003)

**Abstract:** The paper presents results of three-dimensional physical modelling and computer simulations of fluid-flow structures, mixing and combustion processes in a 125MW tangentially fuel-fired boiler and additional fuel – natural gas. This method is commonly called the reburning process, with an emphasis on the reduction of CO, NO<sub>x</sub> and SO<sub>x</sub>. The co-firing process is realized between the main coal burners and additional fuel nozzles. To improve the mixing and combustion processes, a physical technique, the so-called acid/alkali technique, is used to optimize the placement and direction of additional air and fuel nozzles. The best result obtained from physical modelling experiments is studied using numerical simulations with the FLUENT commercial code. Numerical modelling results are then used to analyze the performance of an industrial boiler. These results, compared with measurements in a real boiler, seem to be in good agreement with each other.

**Keywords:** combustion, experimental modelling, air pollutants' reduction

## 1. Introduction

Tangentially pulverized fuel-fired boilers are widely used in power generation. The efficient use of pulverized coal is crucial for the utility industry. To achieve higher combustion efficiency, the major affecting factors, such as the particle size distribution, gas and particle temperatures, local heat release, local oxygen concentration, kinetic parameters for coal devolatilization and char oxidation, as well as coal properties, should be thoroughly investigated. However, there still remain some problems, such as pollutant emission (SO<sub>x</sub>, NO<sub>x</sub>), large amounts of combustible matter in flyash, combustion instabilities at low loads, temperature deviation of re-heaters, slagging in furnaces.

To achieve efficient combustion with low pollutant emissions, control of the flow pattern and the mixing processes inside combustion chambers is necessary. The task is difficult, mainly due to:

- large dimensions of industrial combustion chambers, and
- great differences in flow rates between the mixed streams.

The importance of mixing is particularly well seen if the following in-furnace processes are applied:

- air staging, to limit the formation of  $\text{NO}_x$  by injecting secondary air and decreasing primary air,
- fuel staging, which converts  $\text{NO}_x$  to  $\text{N}_2$  by injecting extra fuel (gas, liquid, solid) into the flue gas stream within the required “level of temperature” and stoichiometry,
- Selective Non-Catalytic Reduction (SNCR), to reduce  $\text{NO}_x$  by injecting an aqueous solution of special chemicals into the flue gas stream within the chemicals’ specific “temperature window”,
- flue gas recirculation, to improve mixing and limit the formation of  $\text{NO}_x$  by co-injection into the flue gas stream together with another media, *e.g.* reburning fuel or urea,
- dry sorbent injection, to reduce  $\text{SO}_x$  emission.

Efficiency of these processes depends on control of the mixing of turbulent jets of air, fuel and flue gases or sorbent and the main cross-flow of flue gases. Mass flow rate of the secondary mass flow of air and reburning fuel is normally much lower than the main flow of the flue gases.

## 2. Description of the boiler

The Limhamn district heating plant consists of one 125MW hot-water boiler, which delivers heat to the District Heating System of Malmö, Sweden. The boiler was built in 1985 and is equipped with the so-called Low  $\text{NO}_x$  burners for pulverized coal, as well as an overfire air system, OFA. The boiler is coal-fired, equipped with two coal burners and two oil burners placed tangentially in each corner. The oil can be used as an alternative fuel. Its internal dimensions are: height 23.6m, width 7.42m, and depth 6.78m. The walls are made of water tubes with an external diameter of 0.0603m and distance of 0.08m between the centres of two neighbouring tubes. Surface temperature is approximately 230°C. The total heat receiving surface of the walls is 840m<sup>2</sup>. During the experiments only the coal burners were used. Directly below the burners, there are secondary air ports, and the overfire air ports are located about 1.3m above the top oil burner, Figure 1.

Sulphur oxide reduction is achieved through direct injection of lime into the boiler furnace. Electrostatic precipitators reduce the emission of flyash by 99.8%.

Concentration of  $\text{NO}_x$  in the waste gas is of the order of 240ppm. Thus the emissions of both  $\text{NO}_x$ ,  $\text{SO}_x$  and particulates are low, when compared to other similar boilers in Sweden.

To meet more stringent emission standards in Sweden, an environmental project has been undertaken. Its objectives were to reduce the emissions of all three air pollutants, CO,  $\text{NO}_x$  and  $\text{SO}_x$ , using the reburning technology.

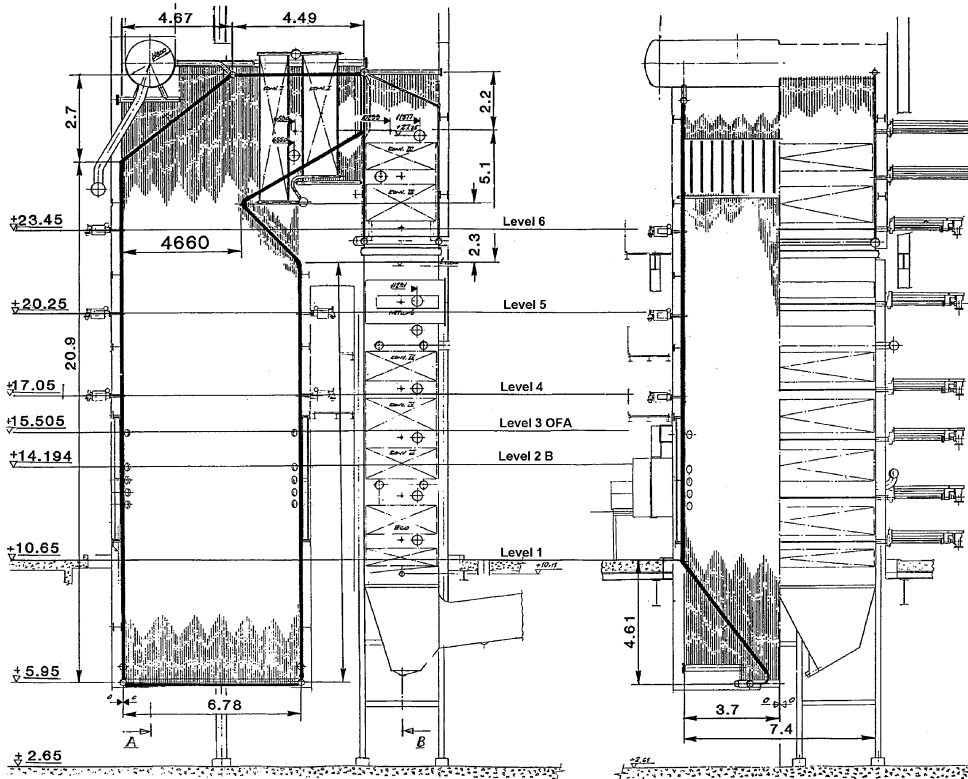

Figure 1. Layout of the 125MW hot water Limhamn district heating tangentially pulverized fuel-fired boiler, [1]

Primary in-furnace measures to reduce  $\text{NO}_x$ , such as air staging and fuel staging were studied with consideration to the boiler's geometry and operating conditions.

Before a reburning system was installed, a series of experiments in 1 : 70 and 1 : 40 scaled models of the boiler had been conducted. The models were built of perspex, and the so-called acid/alkali method was used to study the mixing of fuels and air, as well as the dimensions and optimum positions of the natural gas and additional air nozzles. Base line experiments in the boiler itself were also conducted, which consisted of an extensive mapping of the temperature distribution and the distribution of oxygen, carbon dioxide, carbon monoxide and nitrogen oxide in the boiler furnace.

The first series was a factor experiment in which the direction of the two sets of nozzles were systematically changed. The content of  $\text{NO}_x$  in the waste gas and carbon in the flyash was recorded. Moreover, the total thermal load of the boiler, the ratio between the coal and natural gas input and, finally, the stoichiometry of the main combustion zone and the reburning zone were varied, and their influence on  $\text{NO}_x$  and carbon in flyash was recorded.

The two concluding experimental series were the same as the base line experiments, *i.e.* extensive measurements of temperature and concentrations of flue gas components. The two series were run at 100% and 68% of full load.

Parallel with the boiler experiments, a new series of experiments was conducted in the perspex models. The objective of these experiments was to study the influence of the size of the reburning zone and the main combustion zone, in order to explain the results of the boiler experiments.

The burners and the air ports were directed towards two imaginary circles, concentric around the boiler, as shown in Figure 2. The burners were placed in the corners, about 12m above the bottom. The burner cabinets were 2.45m high, including two coal and two oil burners and a secondary air inlet below the burners. As mentioned above, the coal burners are Low- $\text{NO}_x$ , which means that they have a central zone with under-stoichiometric conditions and the rest of the air is introduced outside this central zone.

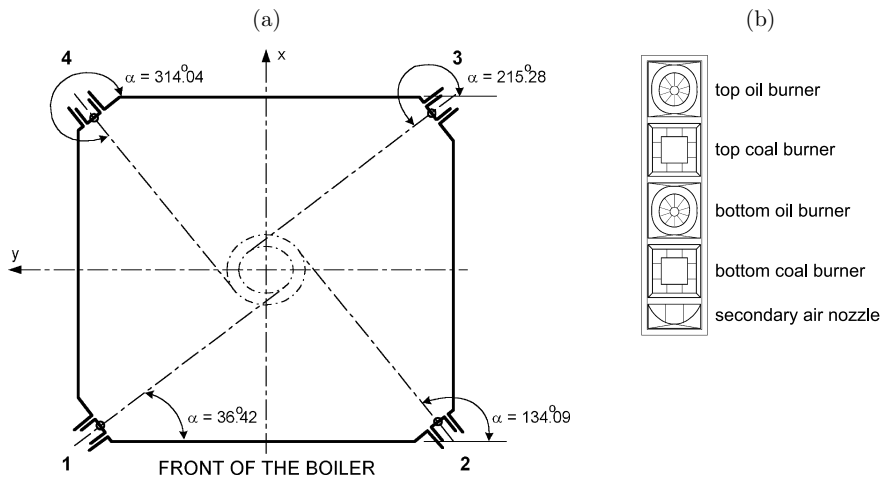

Figure 2. (a) Cross-section of the boiler, [1]; (b) arrangement of the main burners' set

The combustion air is preheated to  $160^{\circ}\text{C}$ , while transport air for coal had a temperature of about  $95^{\circ}\text{C}$ .

The air staging concept was also applied with over fire air (OFA) inlets above the burners. This arrangement created a lower zone with a deficit of oxygen and a higher zone with excess oxygen for fuel burnout.

Coal crushed to powder was used as fuel, and was transported pneumatically to the eight coal burners. Polish coal was used as fuel during these investigations.

### 3. Three-dimensional physical modelling

In an experimental study with a 3D water model, simulations of the flame shapes, as well as of combustion and the mixing processes were studied. For both air and fuel in the experimental boiler, the flows are in the turbulent regime.

The simulations were done in the following sequence: visualization of the flame shapes was achieved by the injection of phenolphthalein to the modeled fuel nozzles, and further combustion and mixing processes were visualized by injecting phenolphthalein and thymolophtalein into the simulated fuel nozzles' flow.

Two different conditions for flame shapes have been simulated and studied in the 3D water model in order to obtain information about the mixing and combustion process which occur in the real boiler.

The concentration of acid in relation to the concentration of alkali was calculated in accordance with the stoichiometric conditions used in the experimental boiler.

The model, which was built of perspex, was connected to a supply system with solutions of acid and alkali via a pump and regulation system consisting of a large number of valves and rotameters to control the volume flow rates.

The 3D water model, shown in Figure 3, was vertically placed in a steel rig and filled with water until the steady-state flow was regulated to simulate the air flow.

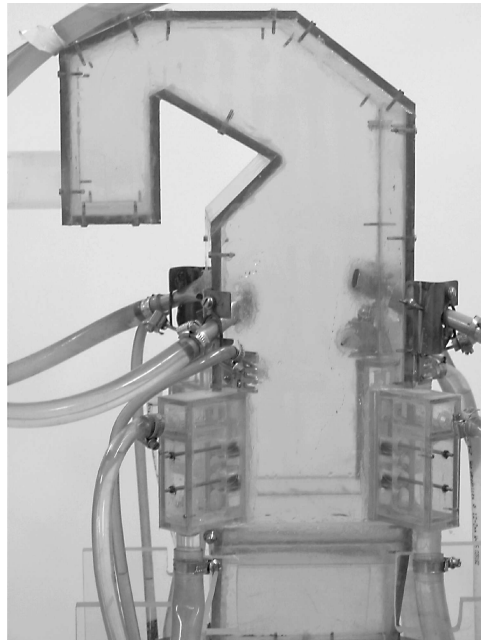

**Figure 3.** Photograph of the 3D model in 1:40 scale, [1]

Two cases, and their conditions, were specified as follows:

1. 125MW = 105MW coal and 20MW natural gas, Figure 4a;
2. 100MW = 80MW coal and 20MW natural gas, Figure 4b.

The objectives of the model experiment were to optimize the position of the UFI and AA nozzles, the ratio of reburning fuel to primary fuel and the stoichiometry in the primary and reburning zones, as well as to decide which production data should be maintained during the two consecutive experiments in the boiler.

#### 4. Numerical modelling

The code used in this work, FLUENT, is a steady state/transient, finite volume, computational fluid dynamics program that can solve three-dimensional fields of pressure, velocity, temperature, kinetic energy of turbulence, dissipation rate of

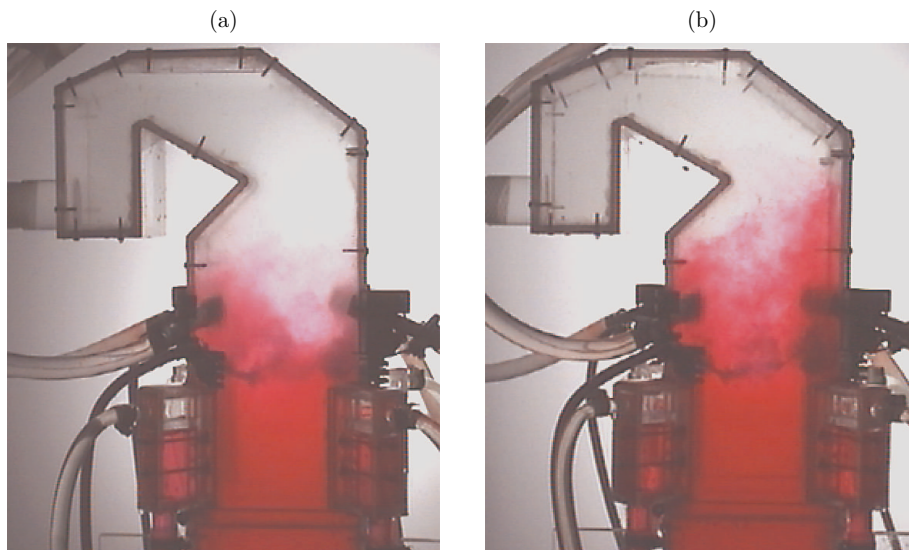

**Figure 4.** Examples of simulation of the combustion process for two cases:  
(a) 125MW; (b) 100MW, [1]

turbulence, and several chemical species. The code operates by solving the governing differential equations of flow physics by numerical means on a computational mesh and is able to predict gas velocity, temperature profile and concentration fields.

In order to simulate the interaction between flames with strong turbulent flows, the renormalization group (RNG)  $k$ - $\epsilon$  turbulence model and a 3D mesh case of whole boiler, together with all burners and nozzles, are established.

Combining the body-fitted meshing capabilities with unstructured non-orthogonal grids and arbitrary coupling between mesh blocks gives great flexibility in representing highly complex geometries. However, the geometry of the boiler is not complicated. The main problem with regard to the geometric representation of a recovery boiler is the geometry of burners, with all of their elements.

For grid generation, an unstructured finite-volume grid is used to divide the very complex geometry of the flow domain into discrete segments with high grid quality. This approach is very important to obtain a convergent and accurate solution.

The finite volume method and a first-order upwind scheme are used to convert elliptical partial differential equations into algebraic equations, which can be solved by the iteration method.

The standard Simple scheme is used for pressure-velocity coupling, while the under-relaxation method is used to control updating the computed variables during the iteration process.

One utility boiler has been chosen for study. In the first case, it operates with the conventional firing system, with a main burner level and an over-fire air level, while in the second case the boiler has additional eight nozzles, four for additional fuel supply and four for air delivery.

The furnace is  $6.78 \times 7.42 \text{ m}^2$  in cross-section. The height to the midpoint of the bull nose is 18m. Combustion air enters the unit through 24 inlets. The air supply is a combination of primary air, which is introduced mixed with pulverized coal, secondary

air, which is introduced through oil burners and below the burners' set, and over-fire air, which is introduced above the burners' arrangement. The amount of primary air controls the rate of combustion in the chamber. The amount of secondary air controls the overall combustion efficiency. Sufficient amounts of over-fire air must be added for complete oxidation of any unburnt or partially oxidized species originating in the combustion furnace.

In practice, it is difficult to achieve perfect combustion. This is particularly true in large industrial combustion chambers. Various combustion air systems are therefore used. A number of free turbulent jets, or its multiplication, always perform the mixing. This work presents the possibilities of evaluation of a new fuel-air system, called reburning. This evaluation is based on mathematical modelling using CFD and the physical models of one pulverized coal-fired boiler before and after retrofit.

The results of numerical modelling are verified by physical modelling and by in-furnace measurements of flue gas temperatures and concentrations.

To obtain information about flow field and temperature contours, a very detailed simulation was performed. It was to see, how each nozzle and burner may interact with others and with the main flow.

In conventional firing systems, air is delivered to the boiler by coal burners, oil burners, secondary air nozzles and over-fire air nozzles. Primary air transports pulverized coal through the internal parts of coal burners, while combustion air is supplied by their outer parts. The air introduced through oil burners, secondary air nozzles and over-fire air nozzles is delivered at four levels. All burners and air nozzles are located in four corners of the boiler, which referred to as a tangentially firing system, as shown in Figure 5a.

The total volume of the computational domain is about  $117.5\text{m}^3$ , and a total of 427656 tetrahedral cells have been employed to discretise the computational domain. The grid is most dense where the main burners are situated, because of their shape and complicated geometry.

A new firing system after retrofit is different from the old one. Whereas the old system had 24 air inlets and 8 fuel inlets, the new one has the number of air inlets increased to 28 and another 4 fuel inlets are added. The latter deliver natural gas to the boiler. The new air nozzles and fuel nozzles constitute the reburning system in the retrofitted boiler (see Figure 5b).

Now, while the total volume of the computational domain is still about  $117.5\text{m}^3$ , the total number of cells has increased by about 100000, to 513362 tetrahedral cells, employed to discretise the computational domain. This is because the additional nozzles are small, and it is necessary to condense the grid where these are situated.

Two cases, corresponding to the industrial boiler before and after the retrofit, respectively, have been simulated. The most important scalars, including fluid flow fields, temperature fields and chemical species concentrations are calculated.

During combustion, the solid fuel is heated and dried. There exists an interaction between the gas and solid phases, fuel pyrolysis and devolatilization, char gasification and combustion. The solid fuel and the gas fuel composition and thermal data are listed in Tables 1 and 2, respectively.

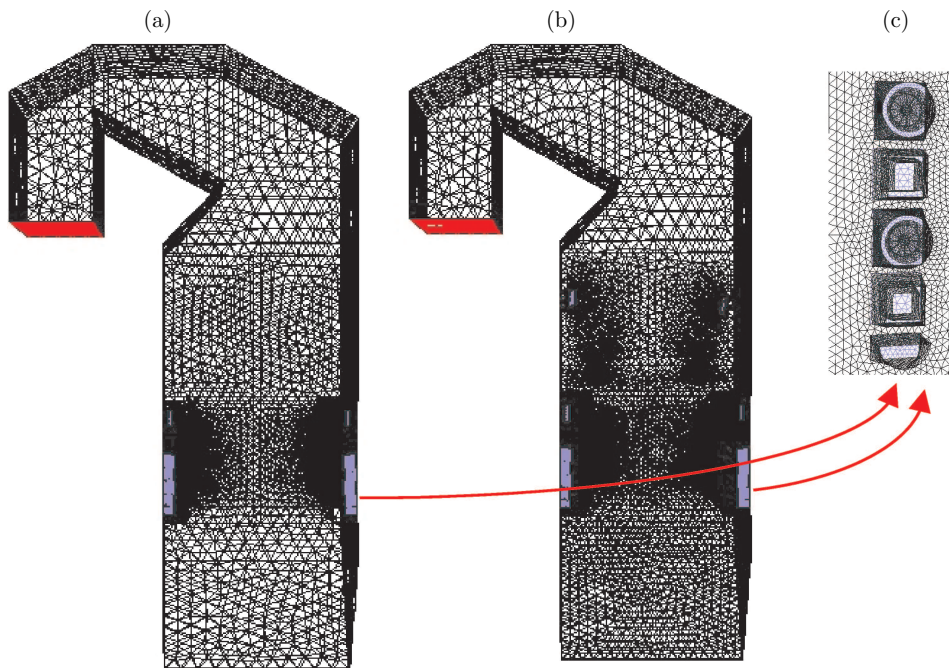

**Figure 5.** The computational domain of: (a) the conventional firing system boiler; (b) the new firing system boiler; (c) closet of main burners' set, [1]

**Table 1.** Coal composition used in numerical calculations

Elements	Coal
C	70.55%
H	4.38%
N	1.3%
O	7.36%
Inertial	9.4%
Volatile	30.5%
Water content	10%
Low heat value	29.67MJ/kg

**Table 2.** Additional reburning fuel (natural gas) composition of main species used in numerical calculations

Elements	Natural gas
CH <sub>4</sub>	91%
C <sub>2</sub> H <sub>6</sub>	4.92%
C <sub>3</sub> H <sub>8</sub>	1.83%
CO <sub>2</sub>	1.03%
N <sub>2</sub>	0.25%
Low heat value	38.85MJ/kg

Similarly, the pyrolysis and combustion reactions for High-volatile coal are assumed to be:

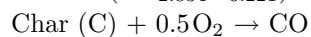
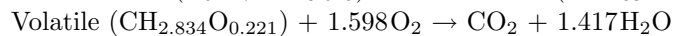
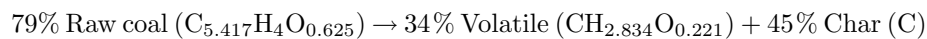

The combustion reactions for the main species of additional fuel are assumed to be:

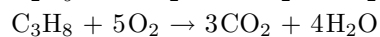
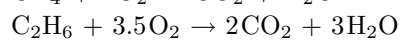
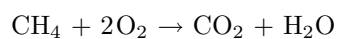



**Table 3.** Kinetic data for the finite rate reaction models:  $v_i$  – the exponents on the concentration of species  $i$ ,  $A$  – pre-exponential factor,  $E_k$  – activation energy for  $k^{\text{th}}$  reaction

Chemical reactions	$v_1$	$v_2$	$v_3$	$v_4$	$A_k$	$E_k$
$C_{1.54}H_{4.28} + 1.84O_2 \rightarrow 1.54CO + 2.14H_2O$	0.7	0.8	0	0	$5.012 \cdot 10^{11}$	$2 \cdot 10^8$
Coal Volatile + $1.598O_2 \rightarrow CO_2 + 1.417H_2O$	0.2	1.3	0	0	$2.119 \cdot 10^{11}$	$2.027 \cdot 10^8$
$CO + 0.5O_2 \rightarrow CO_2 + 0.0H_2O$	1.0	0.25	0	0.5	$2.239 \cdot 10^{12}$	$1.7 \cdot 10^8$
$CH_4 + 2O_2 \rightarrow 2CO_2 + H_2O$	0.2	1.3	0	0	$2.119 \cdot 10^{11}$	$2.027 \cdot 10^8$
$C_2H_6 + 3.5O_2 \rightarrow 2CO_2 + 3H_2O$	0.1	1.65	0	0	$6.186 \cdot 10^9$	$1.256 \cdot 10^8$
$C_3H_8 + 5O_2 \rightarrow 3CO_2 + 4H_2O$	0.1	1.65	0	0	$4.836 \cdot 10^9$	$1.256 \cdot 10^8$

The reactions and kinetic data for the finite rate reaction mode are listed in Table 3.

## 5. Results and discussions

Figure 6 gives a summary of the size of the reburning zone at various angles. The areas and the figures in the boxes give the projected surface of the reburning zone in proportion to the projected area of the total available volume.

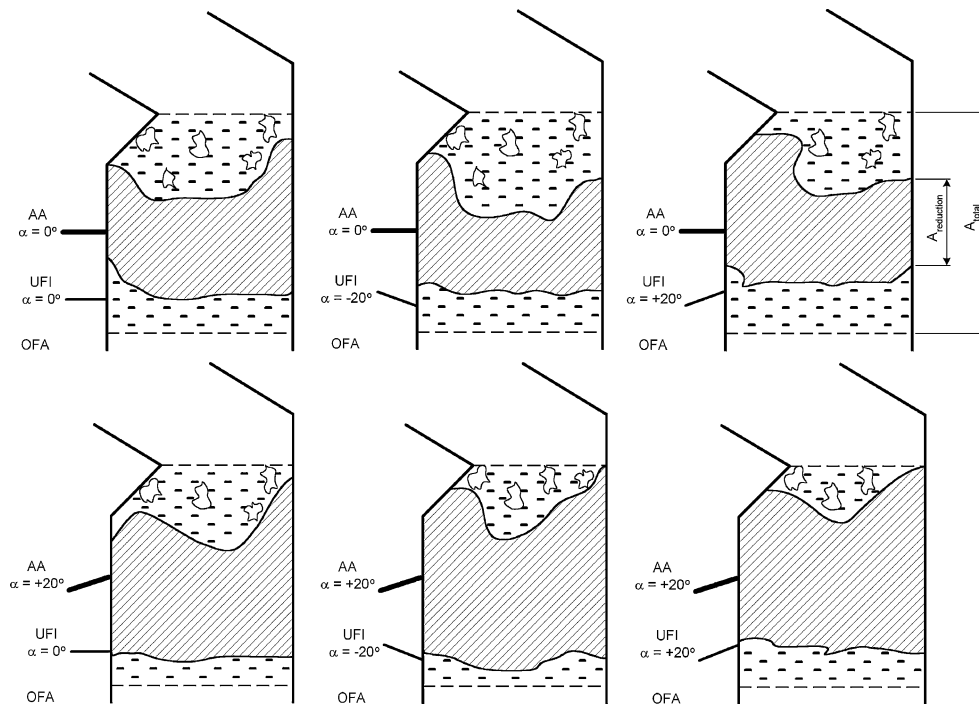

**Figure 6.** Examples of the size of the reburning zone at various angles of the additional air and fuel nozzles, [1]

The figures give a measure of the extent of the available volume that is actually used for reburning. The largest reduction zone is, of course, maintained if the natural gas nozzles are directed downwards and the additional air nozzles upwards. These,

however, reduce the primary zone (see the middle figure). This can lead to an increased concentration of unburned coal after the boiler furnace. By directing both the nozzles upwards, the reburning zone is slightly decreased, but the volume available for coal burnout increases.

Steel beams, which are part of the support construction for the boiler walls, made it impossible to put the reburning nozzles in the corners of the boiler. The model experiments, however, have proven that they could be moved a short distance towards the centre of the wall without reducing the mixing process of furnace gases. Figure 7 shows the position of the upper fuel injection nozzles and the additional air nozzles which was finally selected. The reburning equipment, UFI and AA, should be installed so that it could be tilted  $20^\circ$  from the normal direction in both the vertical and horizontal planes.

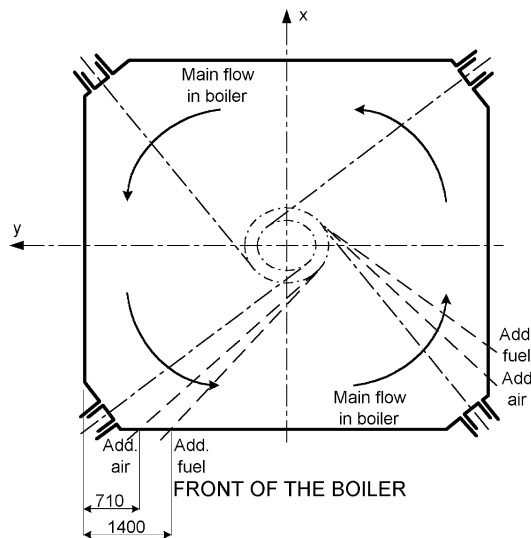

Figure 7. Position of the nozzles for natural gas and additional air in horizontal cross-section

Four different vertical directions of the UFI and AA nozzles have been tested. Obviously, a larger reduction zone maintains a lower  $\text{NO}_x$ -concentration but leads to a higher concentration of unburnt carbon in the flyash.

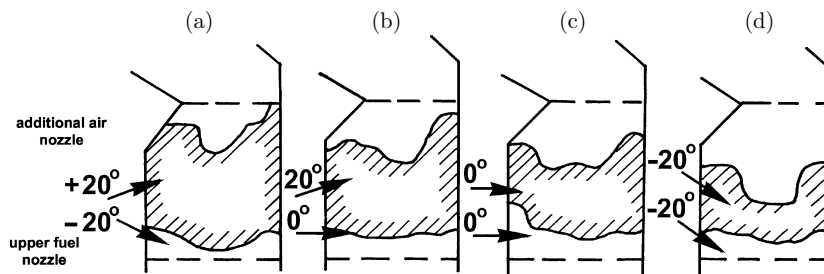

Figure 8. Tilting of the upper fuel injection (UFI) and additional air (AA) nozzles in the vertical direction: its influence on  $\text{NO}_x$  emission and unburnt C in flyash, [1];

$\text{NO}_x$  ppm: (a) 80–110, (b) 100–120, (c) 110–130, (d) 120–140;

C in flyash: (a) 15–20%, (b) > 20%, (c) 10–12%, (d) < 10.5%;

Lower  $\text{NO}_x$  concentrations in the waste gas from the boiler furnace, which are maintained for larger reduction zones, probably depend on longer residence time. The fact that the concentration of unburnt carbon decreases with decreasing size of the reduction zone indicates that the carbon has not burnt out completely at the entrance to the reduction zone. The nitrogen which is fixed in the char, passes right through the reduction zone. When additional air is injected, the coal is ignited for the second time and the fixed nitrogen can form new  $\text{NO}_x$ . In order to increase the burning time before the reduction zone, it should suffice to direct the gas nozzles upwards. In order to at the same time maintain a large enough reduction zone, also the additional air ports should be directed upwards, according to the model experiments (see Figure 8).

Experiments in the boiler and the model have shown that the area with unburnt coal in the center of the boiler, which was observed during the base line experiments, persists when the reburning equipment has been installed.

At 20MW gas injection, there was a tendency towards increased CO concentration in the waste gas (up to 60ppm, compared with the normal 5–10ppm). Experiments in the model have demonstrated that it is possible to solve this problem by directing the additional air ports upstream. Figure 9 shows that the result was the same in the boiler.

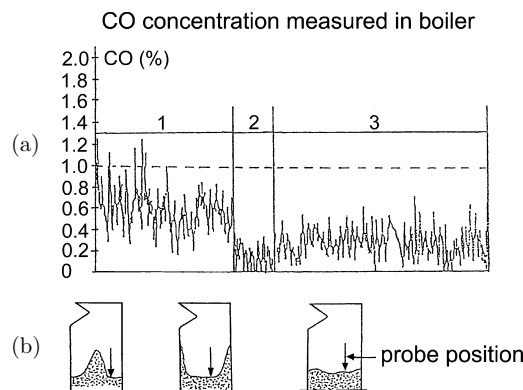

**Figure 9.** The influence of the horizontal direction of the AA ports on CO in flue gases: (a) boiler: 1 – normal position, unburnt in the center; 2 – directed  $10^\circ$  upstream, unburnt along the walls; 3 – two ports in normal positions, two ports  $10^\circ$  upstream – uniform burnout, (b) model, profile of concluded mixing, [1]

Figures 10 and 11 present the velocity flow field for two cases, before and after the modernization of the boiler. In both cases the flow in the bottom of the boiler is similar, but in the second case mixing is increased. Above the main burners' level, the flow is accelerated by the upper fuel jets, due to temperature gradients. The upper fuel flow reaches its maximum velocity of about 250m/s and influences the main flow in the combustion chamber. At the main burners' level, mixing is similar in both cases, due to similar boundary conditions.

Naturally, large eddies are created by the high-speed jets from the fuel burners and the additional fuel nozzles. In the second case, the main core of flow is moved towards the main vertical axis of boiler. In the case before retrofit, plug flow occurs above the over-fire air (OFA) nozzles, while in second case plug flow occurs above the

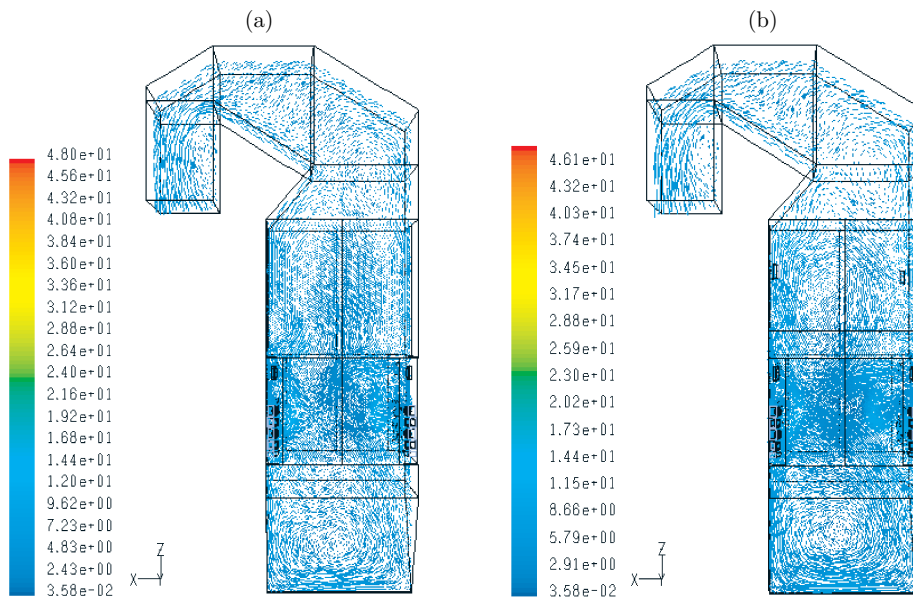

**Figure 10.** Results of the numerical modelling of flow field [m/s] in the front-rear central vertical cross-section: (a) before retrofit; (b) after retrofit

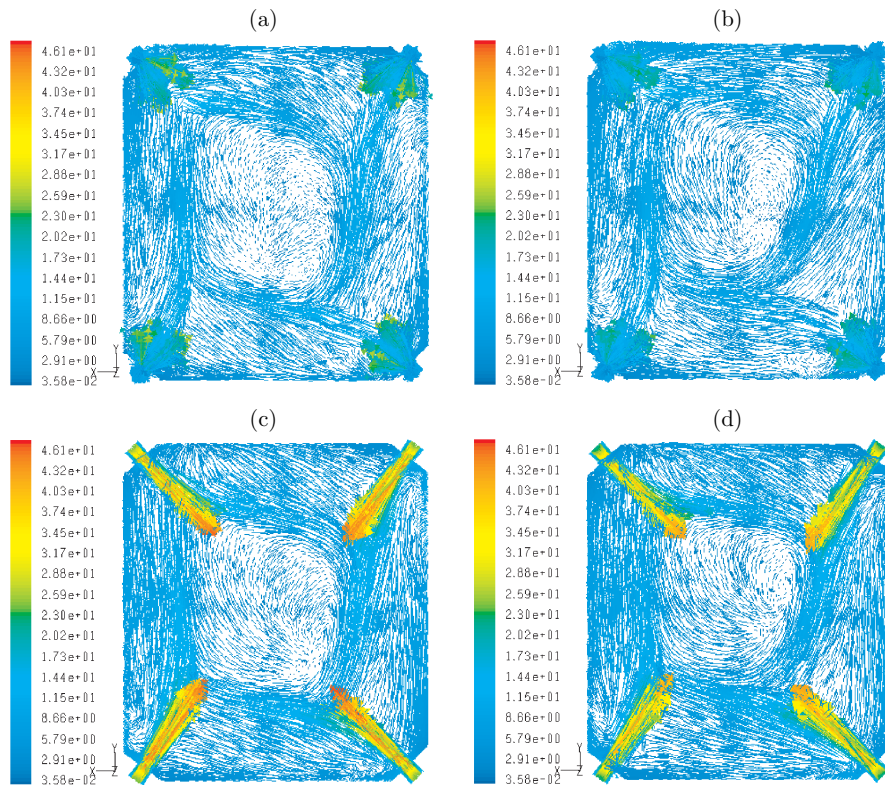

**Figure 11.** Results of the numerical modelling of flow field [m/s]: (a) at the upper oil burner's level before retrofit; (b) at the upper oil burner's level after retrofit; (c) at the upper coal burner's level before retrofit; (d) at the upper coal burner's level after retrofit

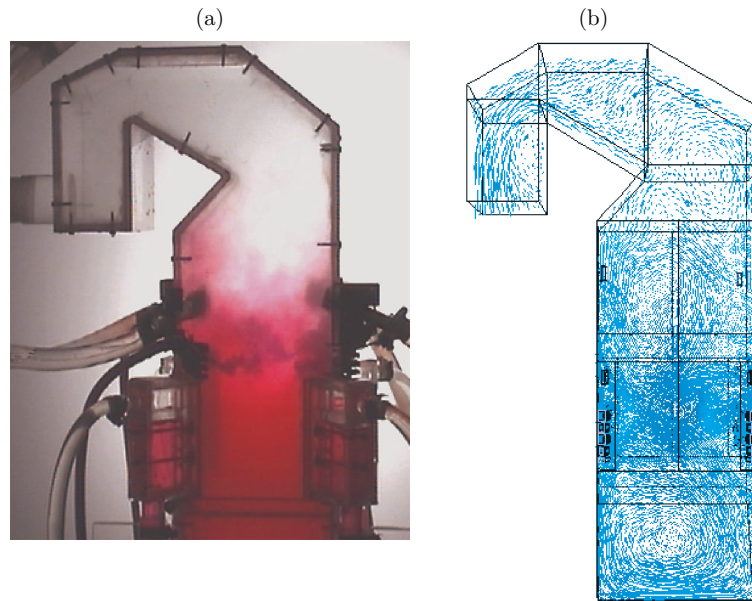

**Figure 12.** Modelling of flow fields for pulverized fuel-fired boiler: (a) 3D physical flow field and mixing process; (b) numerical flow field and mixing process

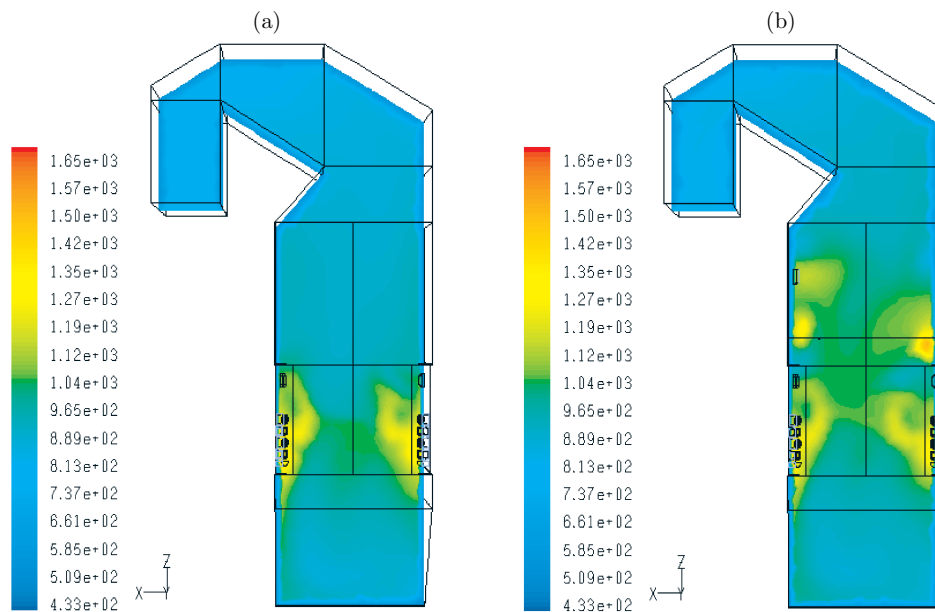

**Figure 13.** Results of the numerical modelling of contours of gas temperature [K] in the front-rear central vertical cross-section: (a) before retrofit; (b) after retrofit

additional air nozzles' level. In the upper part of the combustion chamber, the mixing process is more intensive and mixing occupies a larger volume of the combustion chamber.

Figure 12 presents compared results of fluid flow fields obtained by experimental (physical) and numerical modelling for the case after the retrofit of the boiler. It shows

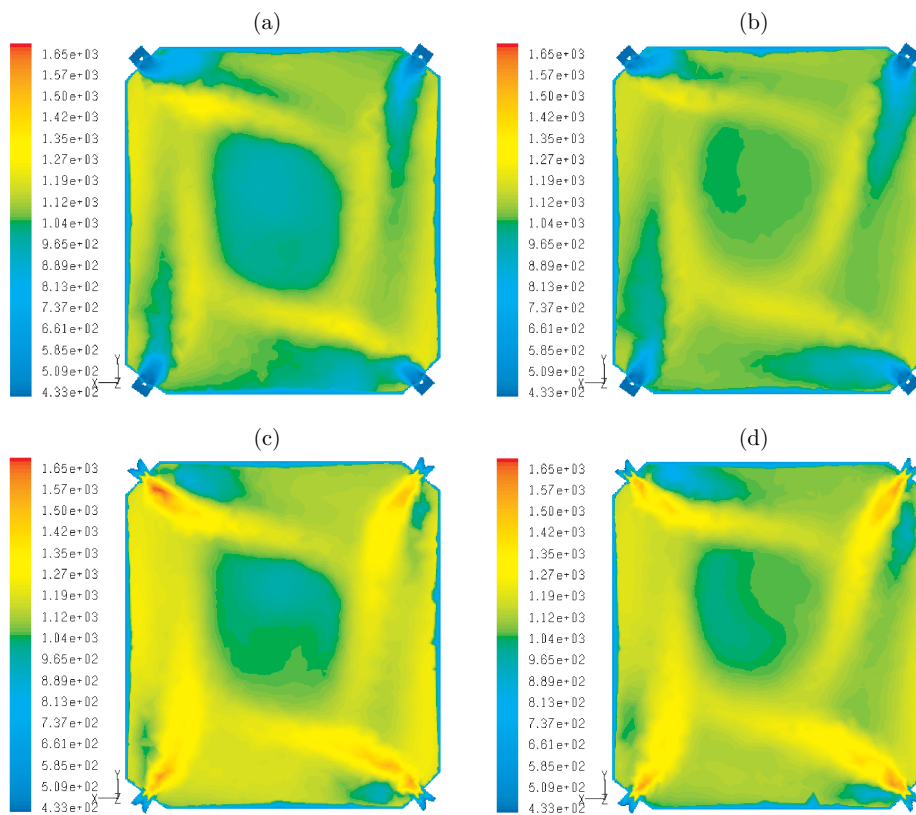

**Figure 14.** Results of the numerical modelling of contours of gas temperature [K]: (a) at the upper oil burner's level before retrofit, (b) at the upper oil burner's level after retrofit, (c) at the upper coal burner's level before retrofit, (d) at the upper coal burner's level after retrofit

a good agreement between the two sets of results. The additional fuel and air nozzles improve the mixing of combustion gases with air and fuel.

Figures 13 and 14 show results of the numerical temperature fields of the two cases, before and after retrofit. They indicate that ports of additional air and, especially, fuel render the flame quite even, and that higher thermal power corresponds to higher temperatures in the combustion region, which occupies more volume of the combustion chamber.

Additionally, the numerical temperature field of the pulverized fuel-fired boiler has been validated by a series of in-furnace measurements, and the agreement between the predictions and the measurements is quite good, as shown in Figure 15.

The differences between the measured and the predicted temperatures are small at two levels, 1 and 3. The predicted and measured lines in both figures look rather well.

Examples of results of the numerical calculations of CO concentration for the boiler have been validated by a series of in-furnace measurements, and the agreement between the predictions and the measurements is quite good, too, as shown in Figure 16.

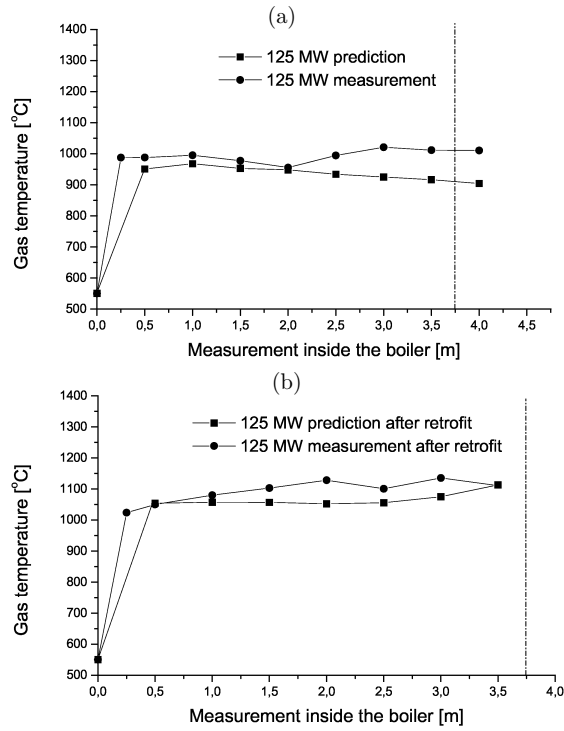

Figure 15. (a) Example of comparison of temperatures at level 1, under the main burners' set; (b) example of comparison of temperatures at level 3, above the over-fire air (OFA) nozzles

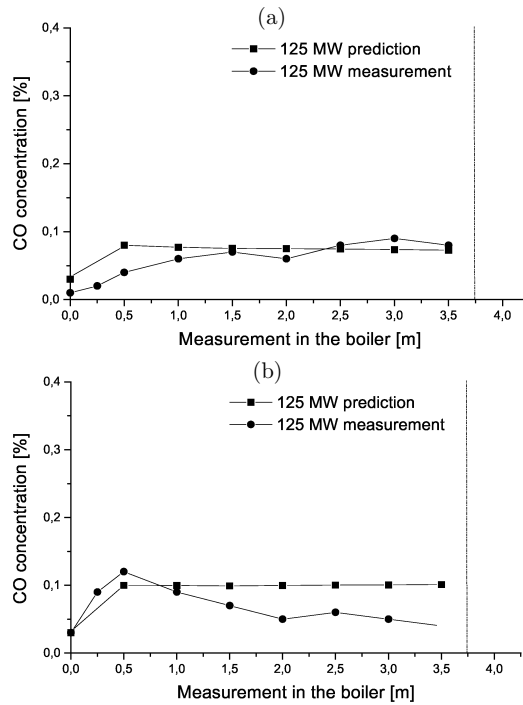

Figure 16. (a) Comparison of CO concentration at level 1, under the main burners' set; (b) comparison of CO concentration at level 3, above the over-fire air (OFA) nozzles

## 6. Conclusions

- After the retrofit, the mixing process in the upper part of the combustion chamber is better, temperature is more uniform and;
- the high temperature zone is smaller and  $\text{NO}_x$  reduction is achieved;
- significantly improves the flow mixing process;
- the direction and angle of the additional air and the upper fuel nozzles have an influence on combustion efficiency and  $\text{NO}_x$  emission: from the combustion efficiency point of view, the case where flyash contains a small amount of C should be suitable, but we must be careful in the retrofit;
- design from the  $\text{NO}_x$  point of view – compromise between combustion efficiency and the amount of air pollutants;
- physical and numerical modelling techniques are successful methods to improve the mixing and combustion process.

### *Acknowledgements*

The financial assistance of the State Committee of Scientific Research (KBN), Poland Grant No 4 T10B 056 22, is kindly acknowledged.

### *References*

- [1] Barański J 2002 *Physical and Numerical Modelling of Flow Pattern and Combustion Process in Pulverized Fuel-Fired Boiler*, Licentiate Thesis, Department of Materials Science and Engineering, Division of Energy and Furnace Technology, Royal Institute of Technology (KTH), Stockholm, Sweden, ISBN 91-7283-415-3