

Influence of burnishing on stress corrosion cracking susceptibility of duplex steel

J. Łabanowski *, A. Ossowska

Gdansk University of Technology, ul. Narutowicza 11/12, 80-952 Gdansk, Poland

* Corresponding author: E-mail address: jlabanow@pg.gda.pl

Received in revised form 15.07.2006; accepted 30.09.2006

Properties

ABSTRACT

Purpose: of the current study was to investigate the usability of burnishing-induced surface enhancement method for improve the stress corrosion cracking resistance of duplex stainless steel.

Design/methodology/approach: The surface layers upon round in cross section specimens were performed through burnishing treatment. Corrosion tests were performed with the use of Slow Strain Rate Test technique in inert (glycerin) and aggressive (boiling 35% MgCl₂ solution) environments.

Findings: It was shown that burnishing treatment increases corrosion resistance of the steel. Stress corrosion cracking resistance depends on the magnitude of cold work at surface layers. High level of cold work decreases corrosion resistance.

Research limitations/implications: This study does not indicate the optimum stress level and stress distribution in surface layers for the best corrosion resistance. It is necessary to continue the research to determine burnishing parameters for demanded properties of duplex steel surface layers.

Practical implications: The burnishing treatment can significantly improve stress corrosion resistance of specified parts of chemical installations working in the contact with aggressive media. Such parts as valve parts or propeller shafts can be successfully protected against corrosion attack.

Originality/value: Burnishing surface enhancement for constructional parts made of duplex stainless steels exposed to corrosive environments has not been reported in literature. Application of this technology can increase life-time of chemical installation devices and improve their reliability.

Keywords: Corrosion and erosion; Surface treatment; Duplex stainless steel

1. Introduction

Over the past few years industry has shown increasing interest in duplex stainless steels for service in aggressive environments. Such steels offer several advantages over the common austenitic stainless steels. The duplex grades are highly resistant to chloride stress corrosion cracking, have excellent pitting and crevice corrosion resistance and are about twice as strong as austenitic steels. The strength and the resistance in corrosive brines make those steels an excellent material for down hole pipings, gathering line pipes, oil and gas separators, heat exchangers and processing

pipings [1-3]. Application of these steels in more aggressive environments requires better protection against corrosive attack. Such protection can be achieved through mechanical surface enhancement methods.

All currently available methods of surface enhancement develop a layer of compressive residual stress following mechanical deformation. The methods differ primarily in how the surface is deformed and in the magnitude and form of the resulting stress and cold work (plastic deformation) distributions in surface layers. The most commonly used treatment is shot peening. Conventional shot peening produces 10% to 50% cold

work [4]. Typical compressive residual stresses reach the alloy yield strength and extend to a depth of 0.05 to 0.5 mm. New surface enhancement technologies have recently been developed, which are superior to shot peening as regards compressive residual stress magnitudes and depths to which compression can be achieved. Laser shock peening (LSP) and low plasticity burnishing (LPB) provide the greater depths of compressive layers by nearly an order of magnitude. The concept of LPB originated as a means of producing a layer of compressive residual stress of high magnitude and depth with minimal cold work [5,6,7].

All mechanical surface enhancement methods give superior fatigue and stress corrosion resistance. It is well known that cracks will not initiate nor propagate in a compressively stressed zone. Fatigue and stress corrosion failures originate at or near the surface of a part will be restricted in such zones. Numerous research works describing influence of shot-peening on corrosion resistance of stainless steels have been already presented [8,9]. Burnishing process is rarely employed for stainless steel parts used in aggressive environments. This treatment gives improvement in surface smoothness besides generating compressive stresses that seems to be more beneficial for stress corrosion resistance [10-16].

The purpose of the current study was to investigate the usability of burnishing-induced surface enhancement method for improve the stress corrosion cracking resistance of duplex stainless steel.

2. Experimental

Examinations were performed on duplex stainless steel grade UR52N+ (UNS S32550). The plate 14-mm in thickness was delivered after solution annealing heat treatment. Chemical composition of the steel is given in Table 1.

Table 1
Chemical composition of the tested steel, [wt. %]

C	Si	Mn	Cr	Mo	Ni	Cu
0.030	0.26	0.87	25.1	3.5	5.8	1.4

Tensile round specimens were machined with the axis situated parallel to the plate's rolling direction. All specimens were divided into three groups. First group consisted of machined samples (St) left without any additional treatment. Specimens of second group (Sp) were mechanically polished using 1200 grade grinding paper and diamond paste. Samples from the third group were subjected to burnishing treatment (S70, S120, S160). Burnishing was performed on the CNC lathe with the use of burnishing tool with ball diamond tip of 2.0 mm in diameter (Fig.1). Three contact forces 70, 120 and 160N were chosen in order to obtain different residual stresses and depths of cold worked layer.

Microstructure of the steel at the surface area after burnishing is shown in Fig.2. The samples surfaces after various mechanical treatments are shown in Fig. 3.

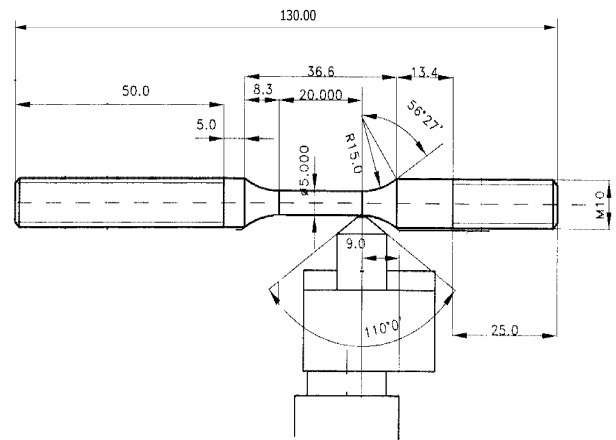

Fig. 1. Diagram of burnishing treatment of specimens for stress corrosion tests

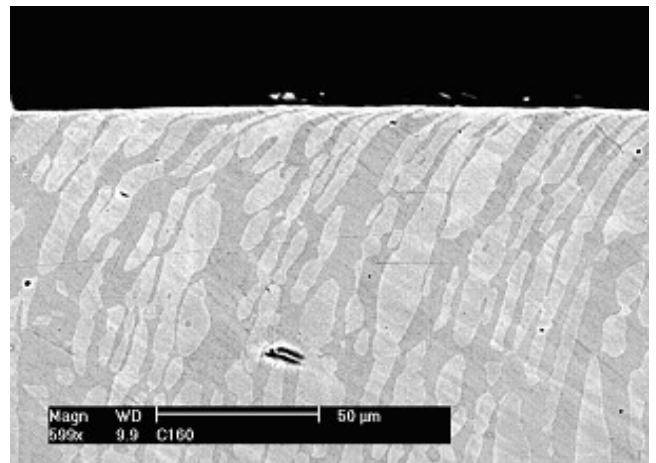

Fig. 2. Microstructure of UR52N steel after burnishing with the contact force 160N. Austenite - bright, ferrite – dark. SEM-BSE

Surface roughness after various treatments are shown in Table 2. Polishing and burnishing with contact forces up to 120 N improved specimens surface quality in comparison to only machined ones. Increase of contact force over 120 N caused swelling and flowing of the material, which resulted in greater irregularity of surface profile.

The depths of cold work layers were determined by Vickers microhardness tests (HV0.2) on the cross section of the samples (Fig.4). The depth of cold work layer is the distance from surface to the point where the measured hardness is equal to base metal hardness + 15 HV.

The susceptibility to stress corrosion cracking was determined in slow strain rate tests (SSRT) at the strain rate of $2.2 \times 10^{-6} \text{ s}^{-1}$ in boiling water solutions of 35% MgCl_2 at 125°C. The supplementary tests in an inert environment (glycerin) were also performed. Lateral and fracture surfaces were examined with the use of scanning electron microscope (SEM). Light microscopy was used for detection crack initiation sites and ways of crack propagation.

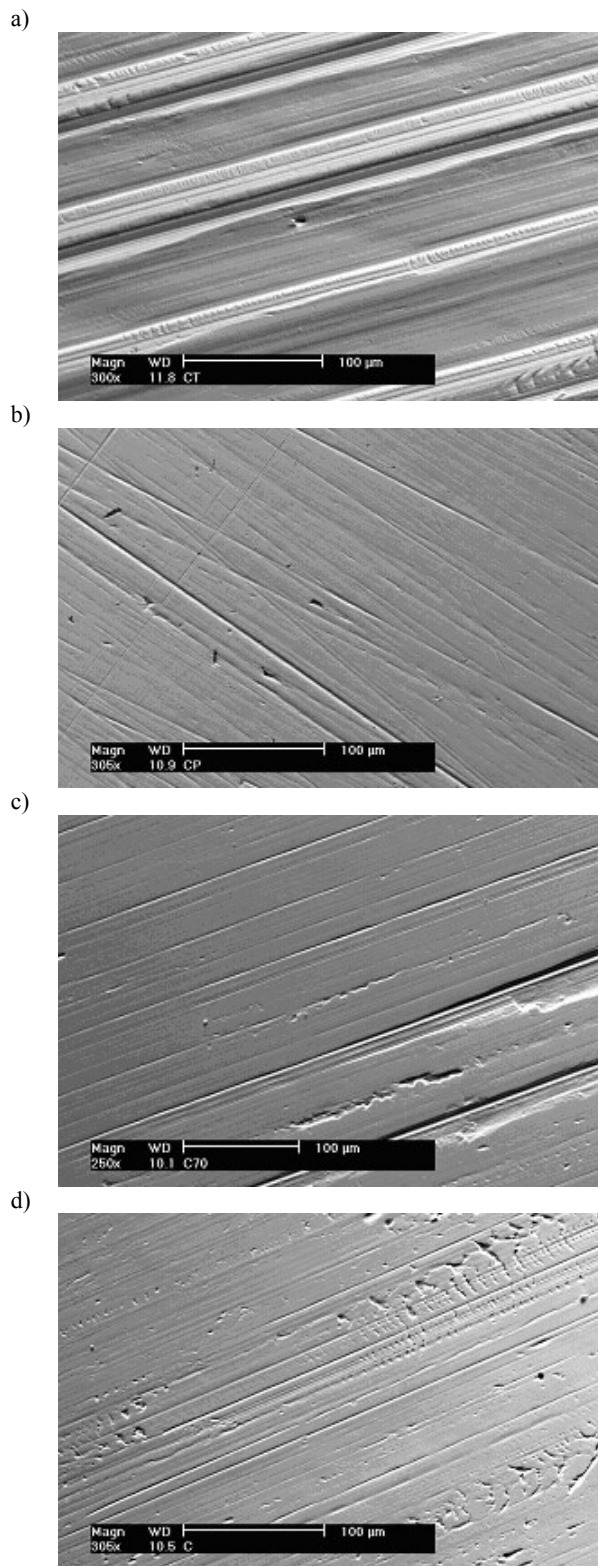

Fig. 3. Surfaces of tested samples: a) machined, b) polished, c) burnished $F=70\text{N}$, d) burnished $F=160\text{N}$

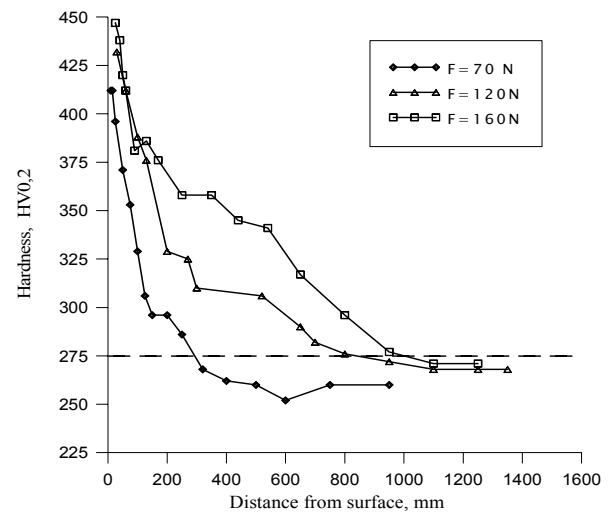

Fig. 4. Hardness distribution at surface layers of duplex stainless steel samples after burnishing

Table 2
Characteristics of surface layers

Sign	Surface condition	Roughness R_a [μm]	Depth of the cold worked layer [μm]	Surface hardness [HV 0.2]
St	machined	0.44		315
Sp	polished	0.06	-	270
S70	burnished 70N	0.06	315	442
S120	burnished 120N	0.08	870	460
S160	burnished 160N	0.20	1020	460

Results of slow strain rate tests are shown in Fig. 5 and Fig. 6. Maximum force, elongation (E) and fracture energy (E_n) were recorded during tests. Reduction in area (RA) in fracture zone was also measured. In order to estimate the loss of plasticity and loss of fracture energy with reference to an inert environment, RA_{rel} , E_{rel} and $E_{n,rel}$ were calculated as a ratio of the specified values for specimens subjected to stress corrosion tests in MgCl_2 solution to that of the specimens tested in glycerin at temperature 125°C . These indicators show contribution of stress corrosion and mechanical factors in damage process of tested specimens.

Fig. 5 show that samples tested in an inert environment has similar mechanical properties regardless on surface condition. The stress-strain curves obtained in corrosive environment (Fig.6) indicate that surface condition of examined samples strongly influenced the stress corrosion cracking susceptibility. Polishing improved SCC resistance in comparison to only machined surface, but both samples exhibited low resistance in test conditions. The best resistance to SCC demonstrated sample S70 with compressive layer obtained by burnishing treatment with lowest contact force. Similar resistance had S120 sample, but the highest contact force of 160 N caused remarkable deformation of material at the sample's surface. The higher surface cold work and greater depth of cold work layer resulted in deterioration of SCC resistance.

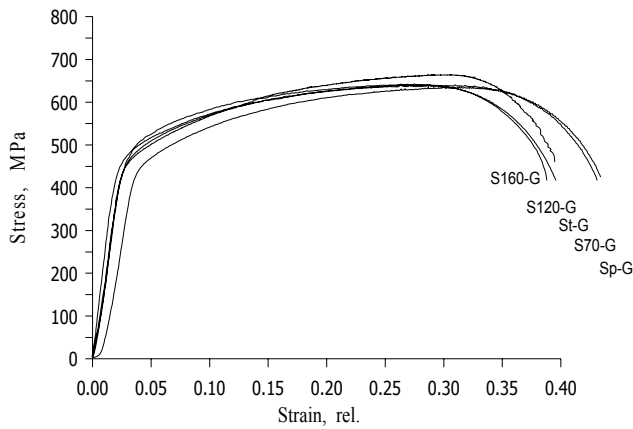

Fig. 5. Slow strain rate test results for samples with various surface layers. Tests performed in glycerin at 125°C

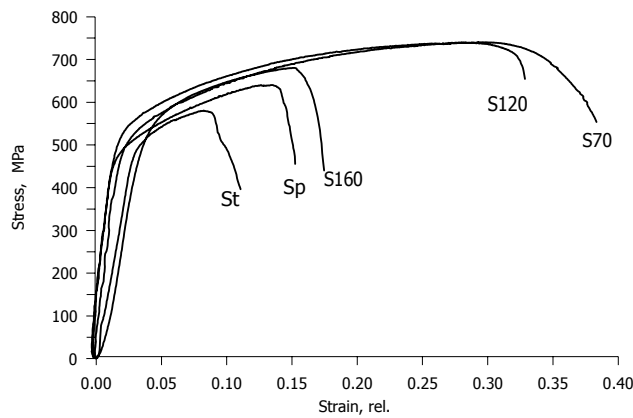

Fig. 6. Slow strain rate test results for samples with various surface layers. Tests performed in MgCl₂ solution at 125°C

3. Discussion

Various stress corrosion cracking resistances of tested samples are a result of two independent factors: (1) the presence of residual compressive stresses in surface layer, and (2) enhancement in surface smoothness.

Enhancement in surface quality reduces the number of crack initiation sites. This effect is clearly visible when compare the SCC resistance of machined St and polished Sp specimens (Fig.6). In this case the improvement in stress corrosion cracking resistance is only due to the better surface smoothness.

Samples with burnished surfaces (S70, S120) demonstrated much better SCC resistance than polished one. Surfaces roughness characterized by Ra parameter were similar in these specimens, so increase in corrosion resistance can be explained only through presence of compressive stresses in surface layers.

The cracking phenomena consist of initiation and propagation phases. The compression stresses present in cold worked surface layer oppose external tensile stress and retard crack initiation process. The propagation of the crack depends on stress conditions near its tip.

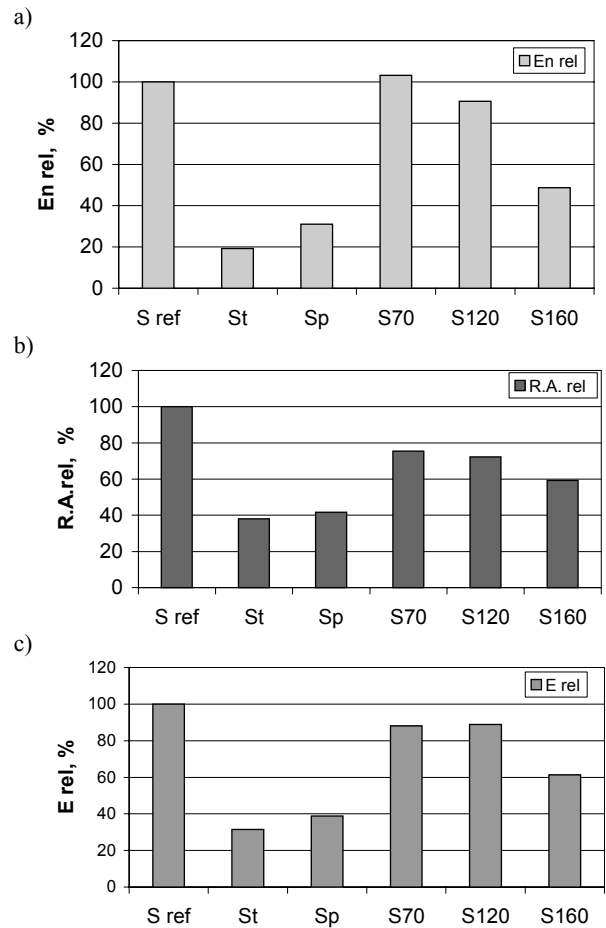

Fig. 7. Relative loss of fracture energy $E_{n,rel}$ (a), reduction in area RA_{rel} (b), and elongation E_{rel} (c) for the samples examined in the SSR tests (mean value for two tests)

Crack arrest by residual compressive stress will not propagate unless tensile stress forces open it near the tip. This mechanism improves SCC resistance, but when cold work level is too high the surface layer becomes brittle and easy breaks under tensile stresses creating a great number of crack initiation sites.

Observations of lateral surfaces of tested specimens after slow strain rate tests confirmed this assumption. Lateral surfaces of only machined specimens were full of straight small cracks initiated on fissures produced by cutting tool (Fig.8). The specimens after polishing (Sp) had only a few large secondary cracks on the lateral surface near the necking.

The lateral surfaces of burnished S70 specimens were free of secondary cracks except the area close to the fracture, (neck of the sample) where great deformation occurred. The secondary cracks showed in Fig.9 appeared during the plastic deformation of this area at the last stage of tensile test. Corrosion cracks could not propagate from these places because of the short time between crack initiation and sample's rupture. It is important to note that S70 samples deformed plastically before rupture just as samples tested in an inert environment (Fig.13a).

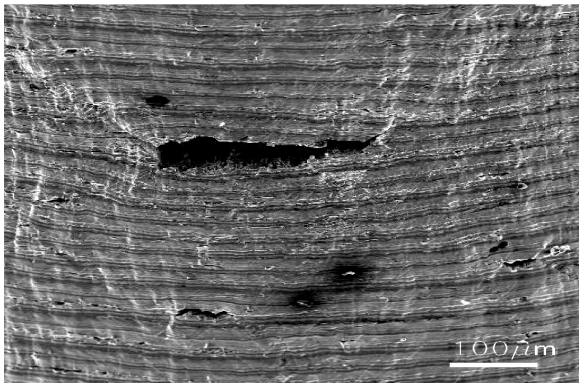

Fig. 8. Lateral surface of only machined (St) sample after SSR tests in boiling $MgCl_2$ solution

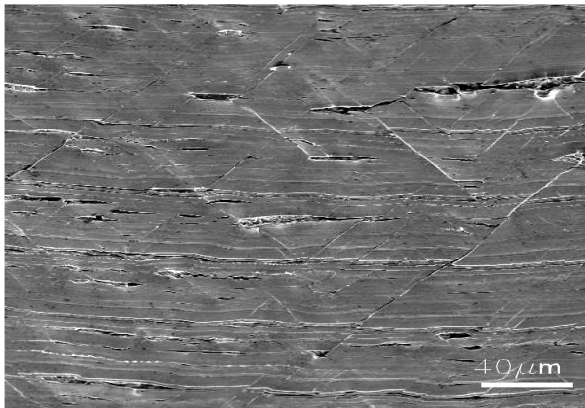

Fig. 9. Lateral surface of burnished S70 sample after SSR tests in boiling $MgCl_2$ solution

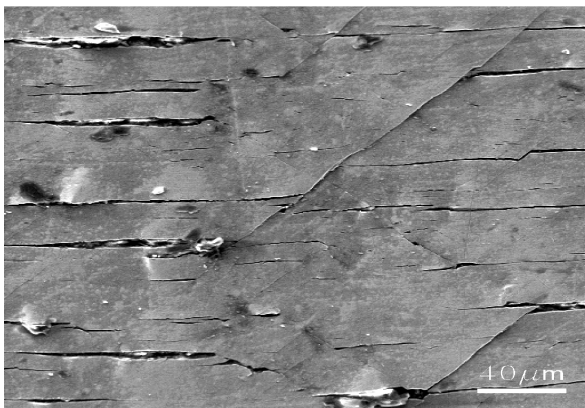

Fig. 10. Lateral surface of burnished S120 sample after SSR tests in boiling $MgCl_2$ solution

Samples S120 showed more cracks situated close to the fracture zone in comparison to S70 samples (Fig.10). Similarly to S70, these cracks created at the plastically deformed zone.

Lateral surfaces of S160 specimens exhibit a great number of cracks situated perpendicularly to specimen's axis upon a whole

gauge length (Fig.11, Fig.13c). These cracks appeared very soon after loading and became an initiation sites for stress corrosion process. The phenomena of crack initiation commence in a compressive layer and mostly propagate transgranular, traverse of austenite and ferrite grains (Fig.12a). Rarely the cracks propagate by ferrite phase and around austenite grains (Fig.12b).

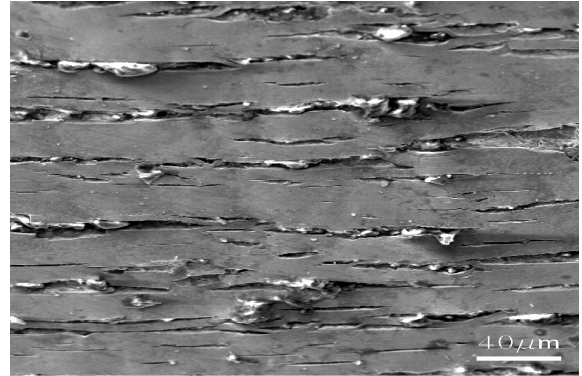
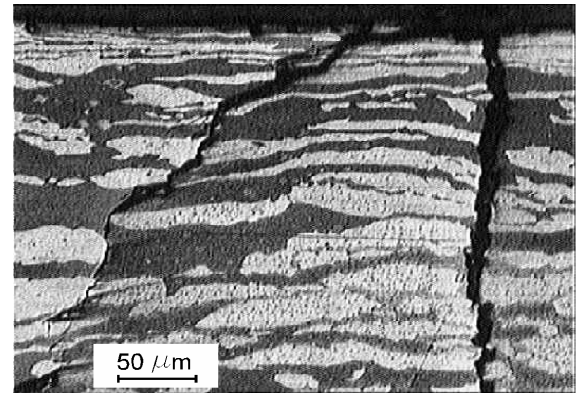

Fig. 11. Lateral surface of burnished S160 sample after SSR tests in boiling $MgCl_2$ solution. Area near fracture zone

a)



b)

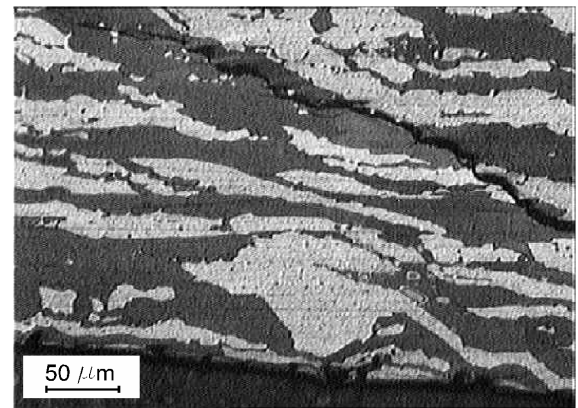

Fig. 12. Crack propagation ways in S120 sample after SSR test in boiling $MgCl_2$ solution

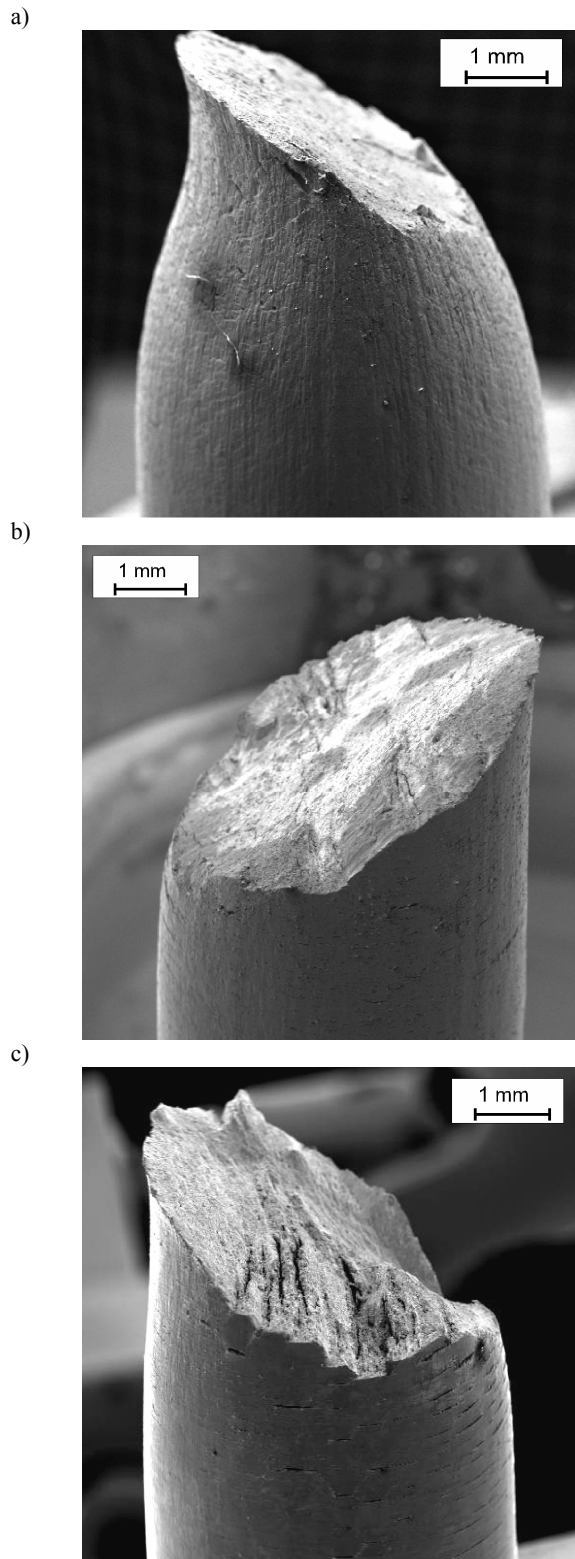

Fig. 13. Fracture area of samples: a) S70, b) S120, c) S160 after SSR tests in boiling $MgCl_2$ solution

All specimens tested in glycerin at $125^\circ C$ exhibit good plasticity and the fracture surfaces were fully ductile. Samples without cold worked layer, St and Sp, tested in $MgCl_2$ solution broke in brittle manner. This alternation in plasticity is a result of stress corrosion cracking phenomena. The loss of elongation (E_{rel}) and reduction in area (RA_{rel}) for these samples ranges from 60 to 80% as it is shown in Fig.7. The fracture surfaces of burnished S70 and S120 specimens exhibit ductile or mixed, ductile-brittle shape (Fig.14a). During corrosion tests these samples deformed mainly plastically without evidence of corrosion attack. Only at the last stage of the test, cracks appeared and corrosion attack could take place. Contrary, the fracture surface of S160 specimen is mostly brittle (fig.14b). In this case, stress corrosion cracking was the main mechanism of material decohesion. The crack initiation phase was very short and ended when brittle cold worked surface layer broke upon the tensile stress.

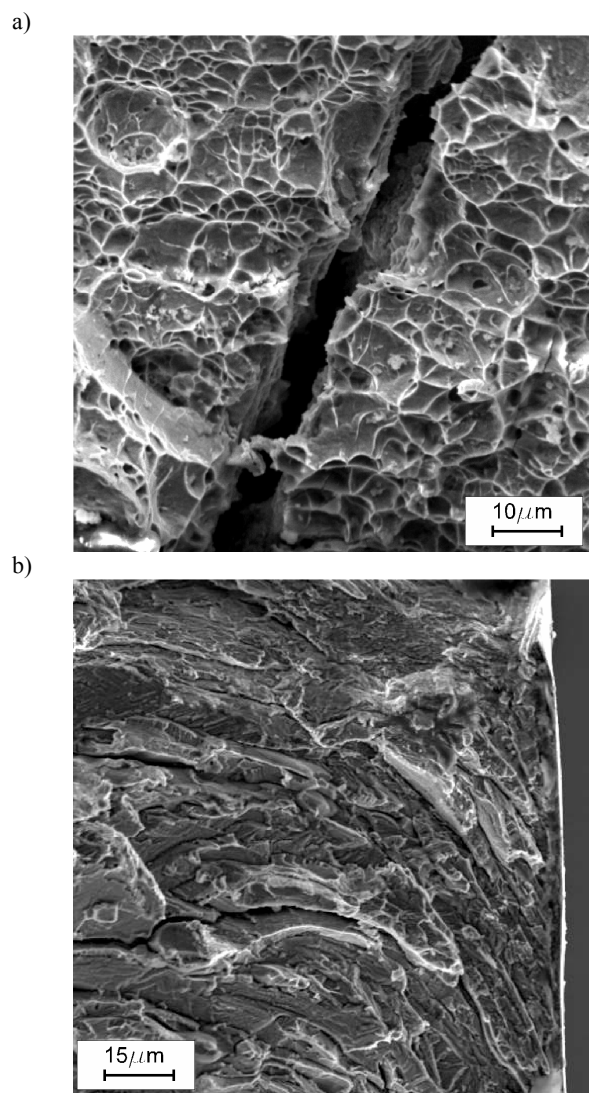

Fig. 14. Fracture surfaces of a) S120, b) S160 samples after SSR test in boiling $MgCl_2$ solution

4. Conclusions

1. Burnishing treatment of surface layers improved stress corrosion cracking resistance of duplex UR52N+ stainless steel samples examined in slow strain rate tests in boiling $MgCl_2$ solution at 125°C.
2. Stress corrosion cracking resistance of burnished samples depends on the magnitude of cold work at surface layers; high level of cold work decreases corrosion resistance.
3. The main factor that improves stress corrosion cracking resistance of burnished specimens is increase of crack initiation time.

References

- [1] J. Charles, Super duplex stainless steels: Structure and properties. Proceedings of Conference "Duplex Stainless Steels '91", Beaune, France, Publ. Les Editions de Physique, 1991, 151-168.
- [2] J. Nicholls, B. Walden, Application of duplex stainless steels in the chemical and petrochemical industry. R&D Centre Sandvik Steel, 1994.
- [3] V. Kuzucu, M. Ceylan, M. Aksoy, Aksoy and M. Kaplan, Investigation of the microstructures of iron based wrought Cr-Ni-Mo duplex alloy. Journal of Materials Processing Technology 69 (1997) 247-256.
- [4] Shot Peening Applications. Metal Improvement Company, Inc. Publication. 2001, Eight edition.
- [5] P. Peyre, et al., Surface modifications induced in 316L steel by laser peening and shot-peening. Influence on pitting corrosion resistance. Materials science and Engineering. A280 (2000) 294-302.
- [6] P.S. Prev y, J. Cammett, Low cost corrosion damage mitigation and improved fatigue performance of low plasticity burnished 7075-T6. Proceedings 4th Int. Aircraft Corrosion Workshop, Solomons, MD, Aug. 22-25, 2000.
- [7] N. Jayaraman, P. Prevey, Application of low plasticity burnishing (LPB) to improve the corrosion fatigue performance and FOD tolerance of alloy 450 stainless steel. Proceedings of the Tri-Service Corrosion Conference, Las Vegas, November 17-21, 2003.
- [8] O. Raquet, D. Feron, P. Todeschini, D. Buisine, Influence of a cold work layer on the propagation of stress corrosion cracks. Proceedings of the Conference "Environmental Degradation of Engineering Materials", Technical University of Gdańsk, Gdańsk, 1999, Vol. I, 205-210.
- [9] A.M. Brass, et al., Role of shot peening on hydrogen embrittlement of a low carbon steel and a 304 stainless steel. Journal of Materials Science 26 (1991) 4517-4526.
- [10] S.S. Lee, S.C. Tam, N.H. Loh, Ball burnishing of 316L stainless steel. Journal of Materials Processing Technology, 37 (1993) 241-251.
- [11] M.H. El-Axir, M.M. El-Khabeery, Influence of orthogonal burnishing parameters on surface characteristics for various materials. Journal of Materials Processing Technology 132, (2003) 82-89.
- [12] M.H. El-Axir, A.A. Ibrahim, Some surface characteristics due to center rest ball burnishing. Journal of Materials Processing Technology 167 (2005) 47-53.
- [13] S.W. Bouzid, O. Tsoumarev, E. Triki, Influence of burnishing on corrosion resistance. Materials Technology, 18(3) (2003) 155-158.
- [14] S.W. Bouzid, J.L. Lebrun, Influence of finishing by burnishing on surface characteristics. Journal of Materials Engineering and Performance 12 (2003) 37-40.
- [15] A.M. Hassan, A.D. Sulieman, Improvement in the wear resistance of brass components by the ball burnishing process, Journal of Materials Processing Technology 96, (1999) 73-80.
- [16] A.M. Hassan, A.M. Maqableh, The effects of initial burnishing parameters on non-ferrous components. Journal of Materials Processing Technology 102, (2000), 115-121.