

Tests of local strains in steel laser - welded sandwich structure

Dariusz Boroński,
 Józef Szala
 University of Technology
 and Agriculture, Bydgoszcz

ABSTRACT

This paper presents results of the tests of local strains in laser weld zone of steel sandwich structure, performed at the Department of Machine Design, University of Technology and Agriculture, Bydgoszcz, in cooperation with the Department of Ship and Offshore Structures Technology, Gdańsk University of Technology, within the frame of ASPIS EUREKA E!3074 project titled : „Application of steel sandwich panels into ship structural design”. Specific features of the tested structure make that in the weld zone both geometrical and structural notch appears simultaneously. The presented results may be helpful in further developing sandwich structures themselves and laser welding technique as well as their design methods as far as avoiding fatigue cracks is concerned.

Keywords : fatigue, laser welding, local strain distributions, laser grating interferometry, steel panel structures

INTRODUCTION

Fatigue life calculations of complex objects, e.g. large ship structures, can be performed with the use of many calculation methods [1,2]. Some of them are based on local approach consisting in that this is variability range of local strains and stresses in the points of their concentration, which mainly decides on fatigue life [3]. In the case of welded joints commonly used in ship structures, strain and stress concentrations are caused both by geometrical discontinuities (geometrical notches) and material non-uniformities resulting from welding process (structural notches).

An example of such simultaneous appearance of geometrical and structural notches can be the novel sandwich panel structures manufactured with the use of laser welding. Such structures constituted the subject of research realized within the frame of ASPIS EUREKA E!3074 project titled : „Application of steel sandwich panels into ship structural design”.

Experimental analysis of local strain distributions in zones of laser weld joint was one of the aims of the research carried out by the Department of Machine Design (PKM), University of Technology and Agriculture, Bydgoszcz, in cooperation with the Department of Ship and Offshore Objects Technology, Gdańsk University of Technology, a participant of the ASPIS project.

The tests were performed at the PKM Laboratory accredited by the PCA (Polish Centre of Accreditation).

PROGRAM AND OBJECTS OF THE TESTS

The program of the tests on deformations in steel panel structure is presented in the form of the schematic diagram shown in Fig.1. It covers the tests under monotonous loading as well as those in conditions of variable loading.

The tests were performed for two types of specimens : B_1 and B_3 elementary structures. Main dimensions of the specimens are given in Fig.2, and places of strain measurements and loading mode of the specimens - in Fig.3. For the tests of strain distributions the laser grating interferometry technique implemented in the LES laser grating extensometer automatic system, was used. The design and working principle of the LES system was presented in detail a.o. in [4,5]. The program

of the tests of strains in steel panel structures covered also the tasks whose aim was to determine cyclic local material properties in particular laser weld zones by using the method described a.o. in [6,7]. Results of the tests within that scope will be published separately.

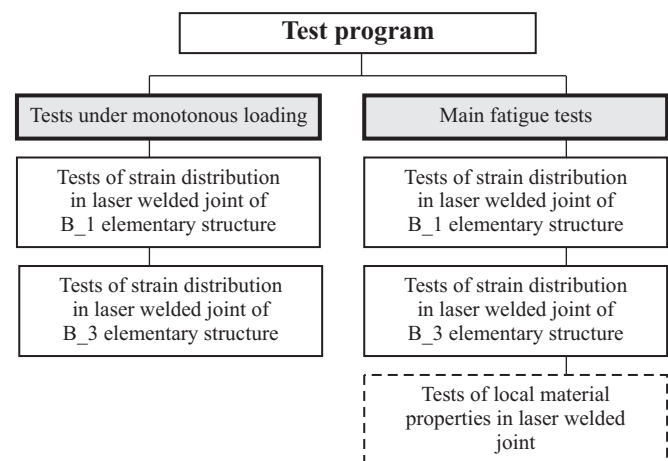

Fig. 1. Schematic diagram of test program .

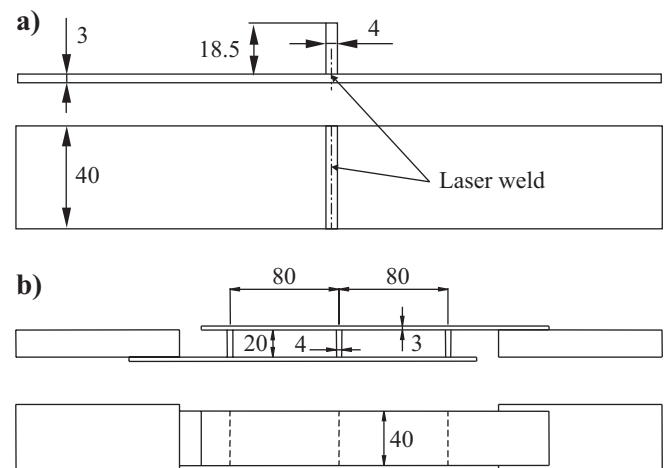

Fig. 2. Specimens, elementary structures used in strain tests :
 a) B_1 elementary structure, b) B_3 elementary structure .

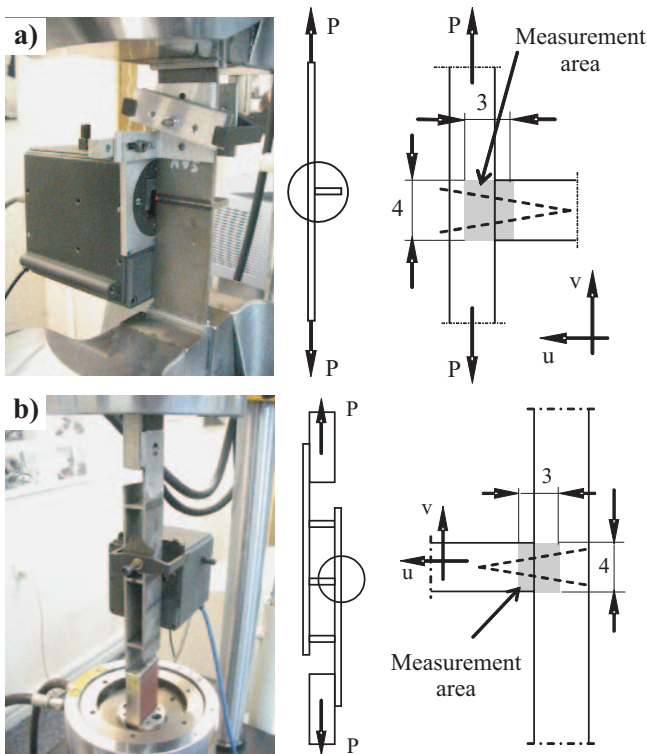

Fig. 3. Location of measurement area in :
a) B_1 specimen and b) B_3 specimen .

RESULTS OF THE TESTS AND THEIR ANALYSIS

The detail analysis of results of the tests of strains in fatigue crack zones was presented in [8]. Due to a limited volume of this paper, in its further part only example results of the measurements and conclusions drawn from their analysis, are presented. During the tests, distributions of relative displacements and strains in two mutually perpendicular directions v and u were determined on the basis of analysis of images of interference lines. In Fig.4 are shown example interferograms as well as strain distribution maps determined by means of the LES system in the course of monotonous tension test of B_1 elementary structure.

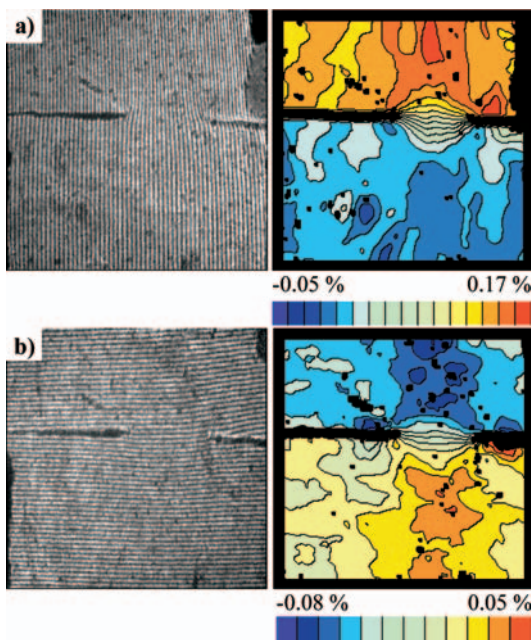

Fig. 4. Example results of measurements : B_1 specimen, force $P = 20$ kN, a) v - direction, b) u - direction .

TESTS OF B_1 ELEMENTARY STRUCTURE UNDER MONOTONOUS LOADING

Measurement of strains in B_1 elementary structure under monotonous loading was performed at 49 levels of static load. The specimens were loaded in compliance with the scheme shown in Fig.3.

For particular values of the force P images of interference lines in two directions of analysis, v and u , were recorded. The measurement was carried out within 3mm x 4 mm measurement area. Strain measurement places are shown in Fig.3.

In Fig.5 are shown example distributions of the strains ϵ_v and ϵ_u , against background of laser welded joint of B_1 elementary structure.

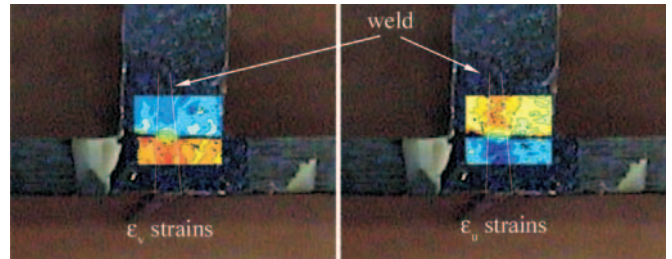

Fig. 5. Strain distributions in B_1 specimen shown on welded joint background .

Analysis of the ϵ_v and ϵ_u strain distributions in selected cross-sections of the joint made it possible a.o. to observe that :

- In the analyzed area of the B_1 structure, both in v and u strain directions, different strain values occur in the plate and web. It generates distinct strain gradients in the joint area, which can be observed in Fig. 6 and 7.

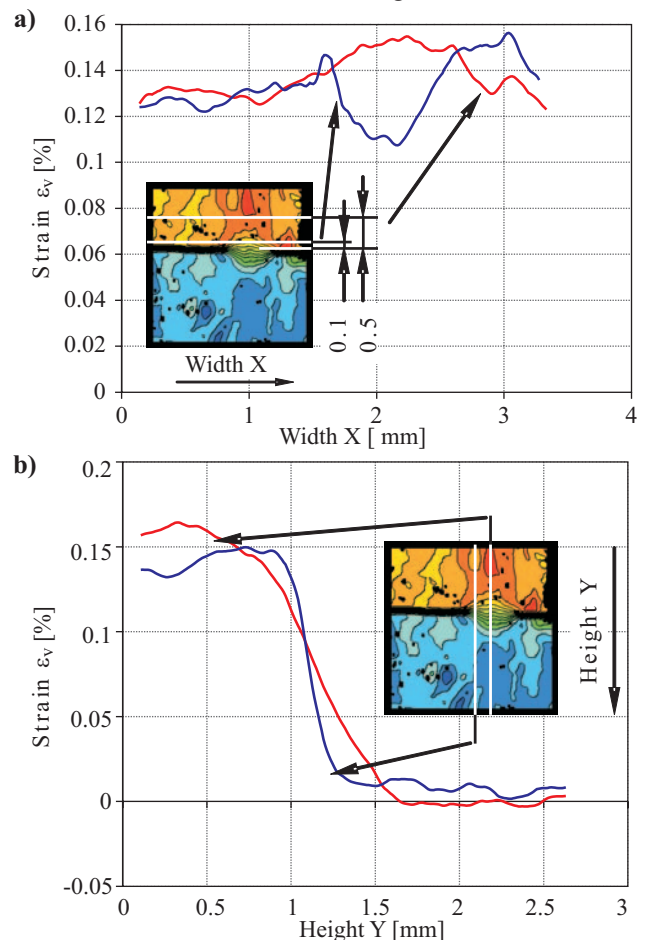

Fig. 6. (ϵ_v) strain distributions in B_1 specimen in load direction : a) along specimen axis and b) transversely to it, for loading force $P = 20$ kN .

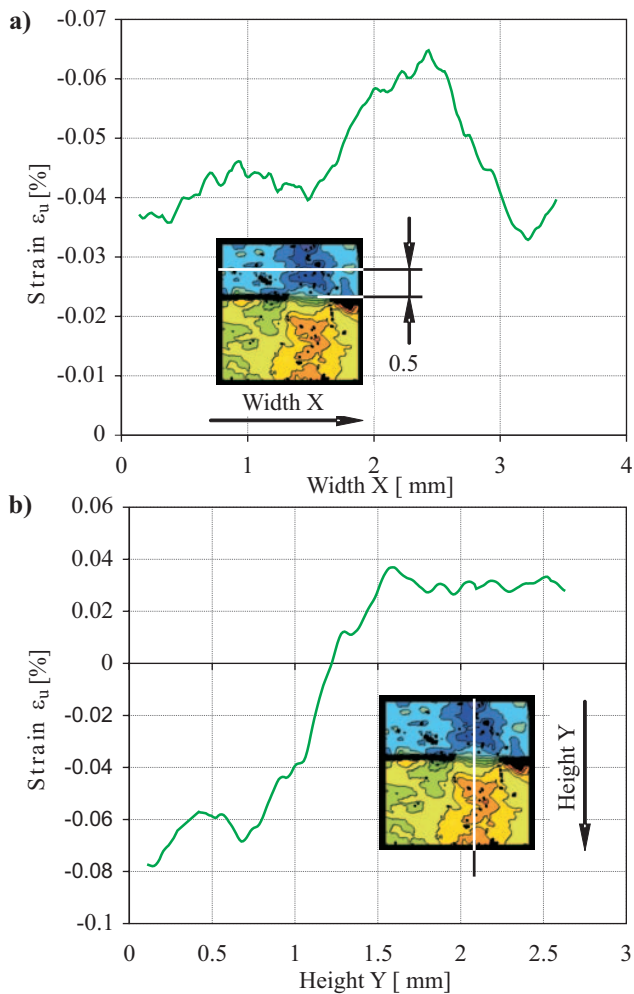

Fig. 7. (ϵ_u) strain distributions in B_1 specimen transversely to load direction : a) transversely to load applied along specimen axis and b) transversely to it .

The largest difference of strain values occurs at the largest load applied to specimen and it decreases along with load decreasing.

The largest strain gradients occur in the area of transition from plate to web, at the weld edge, as well as in the transition zone between the weld and native material.

- Analysis of the strains ϵ_v shows that tensile strains occur in the plate, and in the web the strains are close to zero. And, in the case of the strains ϵ_u compressive strains occur in the plate, and in the web tensile strains appear in the weld zone, and beyond it strain values are close to zero similarly as in the case of the strains ϵ_v .
- In the course of specimen loading, in the weld zone the increasing of ϵ_v and ϵ_u strain values occurs respective to those in native material.

TESTS OF B_3 ELEMENTARY STRUCTURE UNDER MONOTONOUS LOADING

In the tests of B_3 elementary structure 16 static load levels were used. The specimens were loaded in compliance with the scheme shown in Fig.3.

Similarly as in the case of B_1 structure, for particular values of the force P images of interference lines in two analyzed directions **v** and **u**, were recorded. The measurement was performed within 3 mm x 4 mm measurement area located in the region shown in Fig.3.

Analysis of distributions of ϵ_v and ϵ_u strains in laser welded joint of B_3 elementary structure made it possible to state that :

- In the case of strains in **u**- direction, the specimen loading due to axial force, in line with the scheme of Fig.3b, generated, in the zone of the weld connecting the web with the plate, the strain gradient typical for bending load. Simultaneously the web edge exerted compression onto the outer plate, that resulted in building zones of compressive strains in the web and plate in the vicinity of the web edge. (Fig.8).

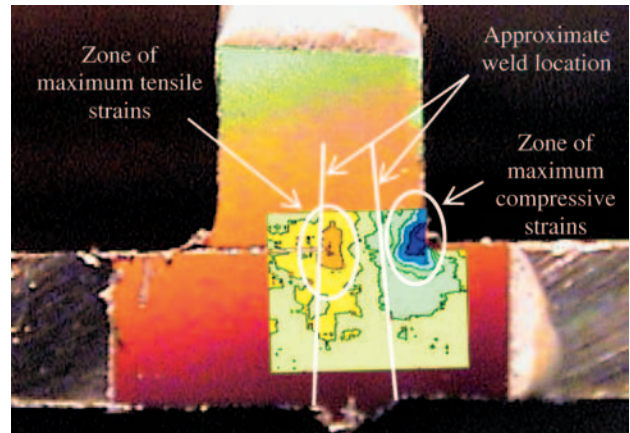

Fig. 8. Strain distributions in B_3 specimen shown on welded joint background .

Total influence of web bending and web-plate contact on strain distribution in the smallest cross-section of the weld is shown in Fig.9.

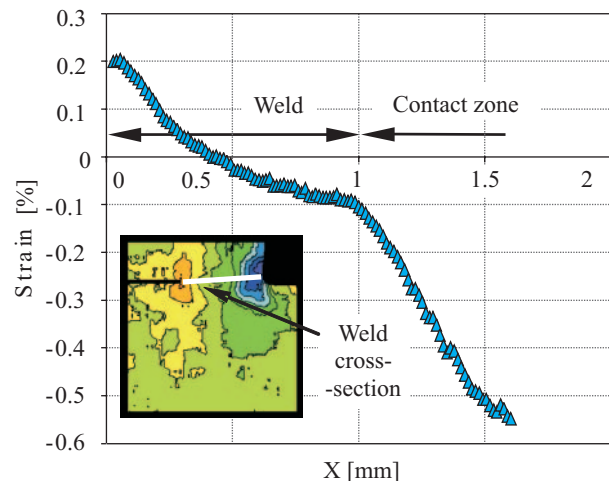

Fig. 9. (ϵ_u) strain distributions in B_3 specimen, in **u**- direction, along the smallest weld cross-section .

- The largest values of tensile strains ((in **u**- direction) in the analyzed area occurred at the weld edge, and those compressive - in the contact area of web and plate (Fig.9).
- Along with load increasing also strain values in the compressed and tensioned areas were increasing, as well as gradual extending the areas into the plate material was observed.
- The strains in **v**- direction show a symmetrical form respective to the line crossing the smallest cross-section of the weld. (Fig.10).

Detail analysis of their typical distribution shown in Fig.10a, makes it possible to expect a probable character of strain process in the laser weld joint zone, as shown in Fig.10b. The web when displacing against the plate, makes the laser weld built of the welding hardened material, rotating. During the rotating, the weld causes the plate bending and forming two respective zones of tensile and compressive strains in the plate and web material on both sides of the weld.

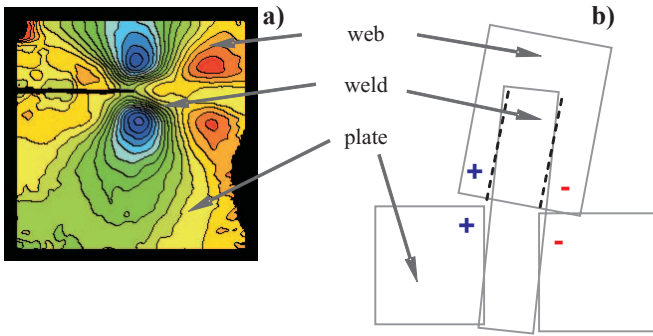

Fig. 10. Schematic diagram of joint deformation - (ϵ_v) strains, in v-direction.

TESTS OF B_1 ELEMENTARY STRUCTURE UNDER VARIABLE LOADING

During the tests, B_1 elementary structure was subjected to sinusoidally variable load of the stress ratio $R = 0$ and the maximum force value $P_{max} = 25$ kN. For five phases of the loading cycle : A, B, C, D and E images of interference lines in two analyzed directions, v and u , were recorded (Fig.11).

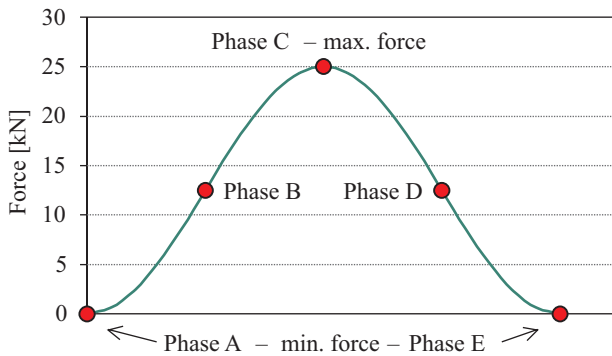

Fig. 11. Strain measurement phases during sinusoidally variable loading.

The strain measurement place is shown in Fig.3. The measurements were executed for every assumed number of load cycles. During the tests, over 20 000 images of interference lines were in total recorded. In Fig.12 the example images of interference lines in the final crack-development phase, are presented.

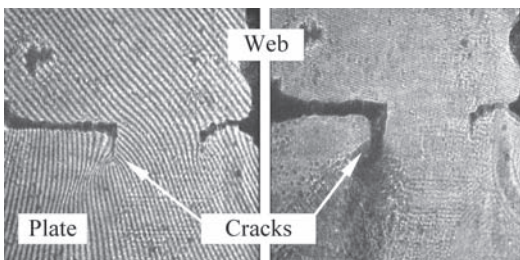

Fig. 12. Image of interference lines in final phase of fatigue life.

In Fig.13 and 14 are shown the example maps of strain distributions in v and u directions, respectively, at the maximum values the force P in load cycle, for some selected load cycles.

In Fig.15 the course of changes of the strains in v -direction in the joint cross-section Y-Y, is shown. In the diagram an approximate course of the weld connecting the web and plate is marked.

Similarly as in the case of static load the simultaneous presence of geometrical and structural notch generated large strain concentration in the joint zone. During fatigue loading, changes of local strain values additionally occur, and they have different

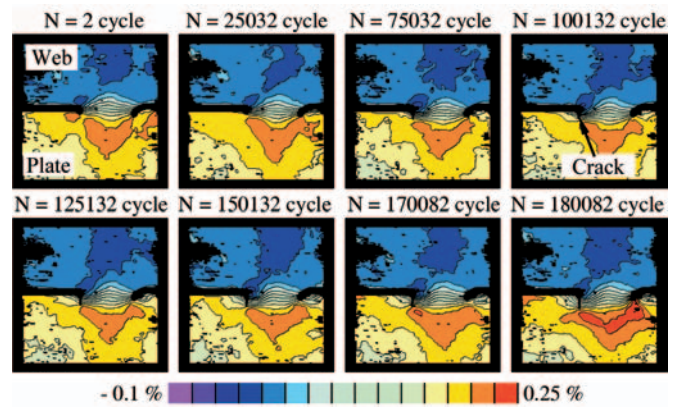

Fig. 13. Strain distributions in v- direction.

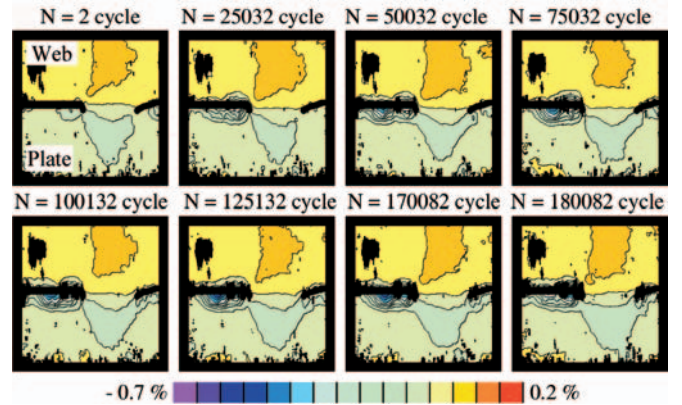

Fig. 14. Strain distributions in u- direction.

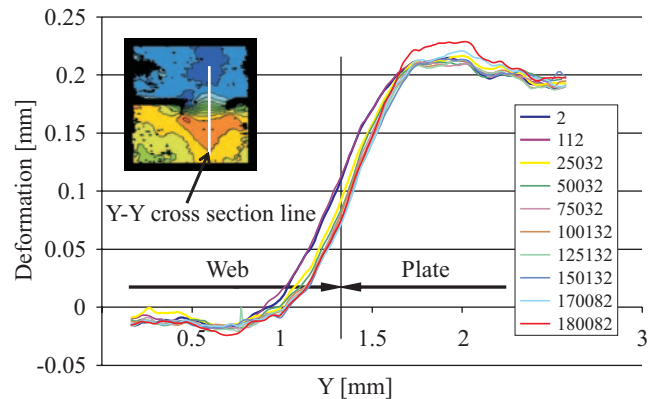

Fig. 15. Strain distribution in v-direction in Y-Y cross-section, recorded in successive load cycles.

character in different joint areas. In the diagram shown in Fig.16 is presented the course of changes of the resultant strains ϵ_{uv}

(i.e. $\epsilon_{uv} = \sqrt{\epsilon_u^2 + \epsilon_v^2}$) in the point of their maximum values

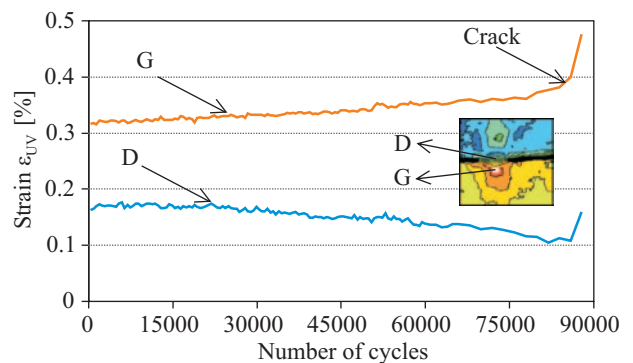

Fig. 16. Run of changes of the maximum value of ϵ_{uv} strain during fatigue test.

(marked „G” in Fig.16), and in the transition zone between the plate and web (D). Strain differences in the zones make the strain concentrations in the joint, largest. Along with successive load cycles, values of the maximum strains (G) were increasing and those of the strains (D) – decreasing. It caused the strain gradient increasing during the fatigue test.

To illustrate the strain concentration effect in weld zone, were elaborated the maps of distributions of gradients of ϵ_{uv} resultant strain, calculated as :

$$G = \left| \frac{\Delta \epsilon}{\Delta L} \right|$$

where :

$\Delta \epsilon$ – range of % strain change over ΔL section

ΔL – assumed length of the section, corresponding with total distance of six neighbouring measurement points, equal to 0.06 mm.

In Fig.17 is shown the distribution of gradients along the transverse direction respective to load direction, so determined in selected successive load cycles. Their analysis makes it possible to observe that the largest gradient values occur in the transition zone between plate and web, and that along with successive strain cycles the gradient value increases and it a little shifts toward the plate simultaneously.

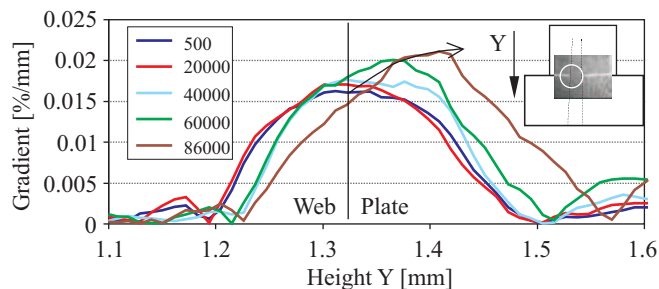

Fig. 17. Gradients of ϵ_{uv} strain .

The place of occurrence of the largest strain gradient complies with that of fatigue crack initiation, which can be observed by comparing Fig. 16 and 17.

TESTS OF B_3 ELEMENTARY STRUCTURE UNDER VARIABLE LOADING

The B_3 elementary structure was subjected, similarly as in the case of the B_1 structure test, to sinusoidally variable load of the stress ratio $R = 0$ and the maximum force value $P_{max} = 1.5$ kN. The measurements were performed at five phases (A, B, C, D and E – Fig.11) of selected load cycles.

The strain measurement place is shown in Fig.3. The measurements were performed for every assumed number of load cycles. During the test over 1700 images of interference lines were recorded in total. In Fig.18 are shown the example maps of interference lines, recorded during successive phases of 40 101st load cycle.

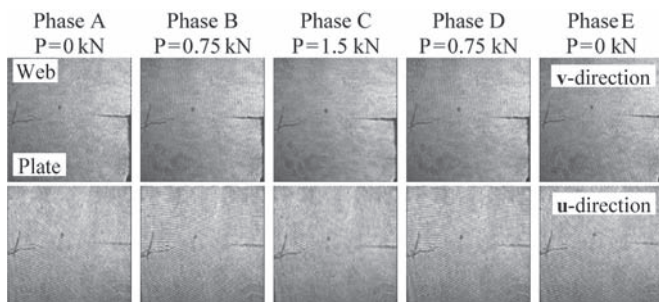

Fig. 18. Example maps of interference lines recorded for the cycle $N = 40101$ in successive load phases .

Analysis of the recorded interferograms made it possible to determine the strain distributions in the analyzed area. The maps of interference lines, determined during the test, were analyzed with the use of several numerical procedures making it possible to identify particular interference lines and their phases in the analyzed area.

In Fig. 19 and 20 are shown the example maps of interference lines in u and v direction, respectively, for the maximum value of the force P , and selected load cycles.

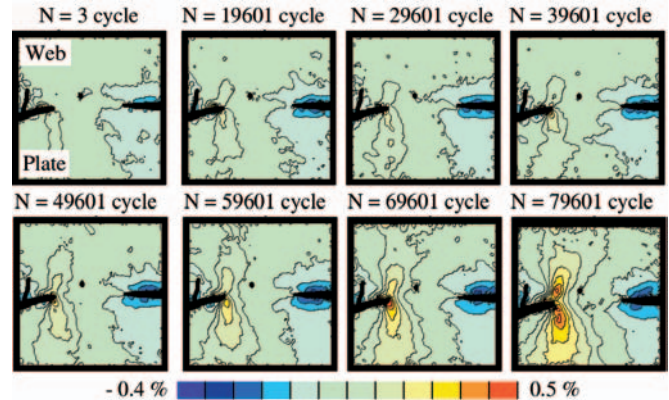
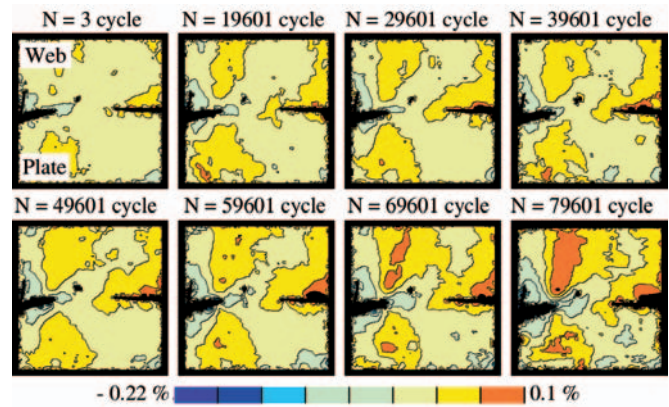

Fig. 19. Strain distributions in v - direction .



Rys. 20. Strain distributions in u - direction .

In Fig.21 is presented the course of changes of the strains in u -direction in the vicinity of the smallest cross-section of the weld and in the contact zone of the plate and web, for selected load cycles. In the diagram an approximate course of the weld connecting the plate and web, is marked.

In the weld zone, like in the case of static load, occurred the strain gradient characteristic for bending, which was additionally amplified by the geometrical notch effect formed by the plate-weld-web transition zone.

Moreover, on the elaborated strain maps compressive strain zones were revealed in the plate-web contact zones.

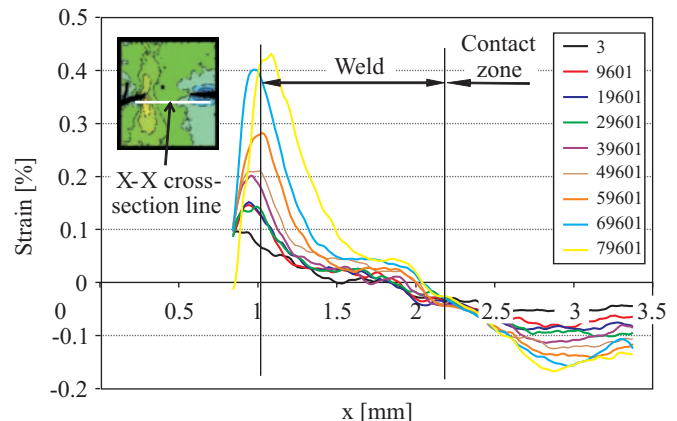

Fig. 21. Strain distribution in u - direction in X-X cross-section, recorded in successive load cycles .

In the analyzed area the largest values of tensile strains (in **u**-direction) occurred at the weld edge, and those of compressive strains – in the web-plate contact zone.

The strain distributions were changing during successive load cycles, showing an increase of the maximum values of local strains and also an increase of strain gradients in the area of weld edge.

SUMMARY

- The applied test method based on the LES automatic laser grating extensometer system, made it possible to determine strain distributions in analyzed zones of welded joint of steel sandwich panel structure at various levels of static loading as well as in successive phases of selected cycles of variable loading.
- It made it possible to analyze course of variability of the selected parameters describing strain state in the joint and to indicate their connection with the places of fatigue crack initiation.
- The performed tests yielded the data useful in elaborating the methods for the calculating of fatigue life of structures of the considered kind, with the use of the local approach based on analysing local strains and stresses.
- The presented results may be helpful in further developing sandwich structures themselves and laser welding technique, as well as their design methods as far as avoiding fatigue cracks is concerned.

- Moreover, the results of the performed tests constitute a source base for analyzing the fatigue phenomena and processes which occur in steel sandwich panel structures under cyclic loading.

BIBLIOGRAPHY

1. Radaj D.: *Review of fatigue strength assessment of non-welded and welded structures based on local parameters*. International Journal of Fatigue No.18/1996
2. Rosochowicz K.: *Problems of the fatigue cracking of ship hulls* (in Polish). Shipbuilding & Shipping Publishing House (Okretnictwo i Żegluga). Gdańsk, 2000
2. Morrow J.D.: *Fatigue Properties of Metals, Manual*. Society of Automotive Engineers, ISTC Div.4, 1964
3. Boroński D., Szala J.: *Research on zones of fatigue crack initiation and propagation, by using LES laser grating extensometer* (in Polish). Przegląd Mechaniczny No.7-8/2002
5. Boroński D., Szala J.: *Laser grating extensometer LES for fatigue full-field strain analysis*. ECF 14 Fracture Mechanics Beyond 2000, EMAS, 2002
6. Boroński D.: *Cyclic material properties distribution in laser-welded joints*. International Journal of Fatigue, Vol 28/4, 2006
7. Boroński D.: *Experimental analysis of strain distributions in fatigue crack zones* (in Polish). ATR University Reports (Wydawnictwa Uczelniane ATR). Bydgoszcz, 2005
8. Boroński D., Szala J.: *Fatigue tests of laser-welded specimens of sandwich structure models* (in Polish). BZ 8-2003 Report, ATR (University of Technology and Agriculture). Bydgoszcz, 2004

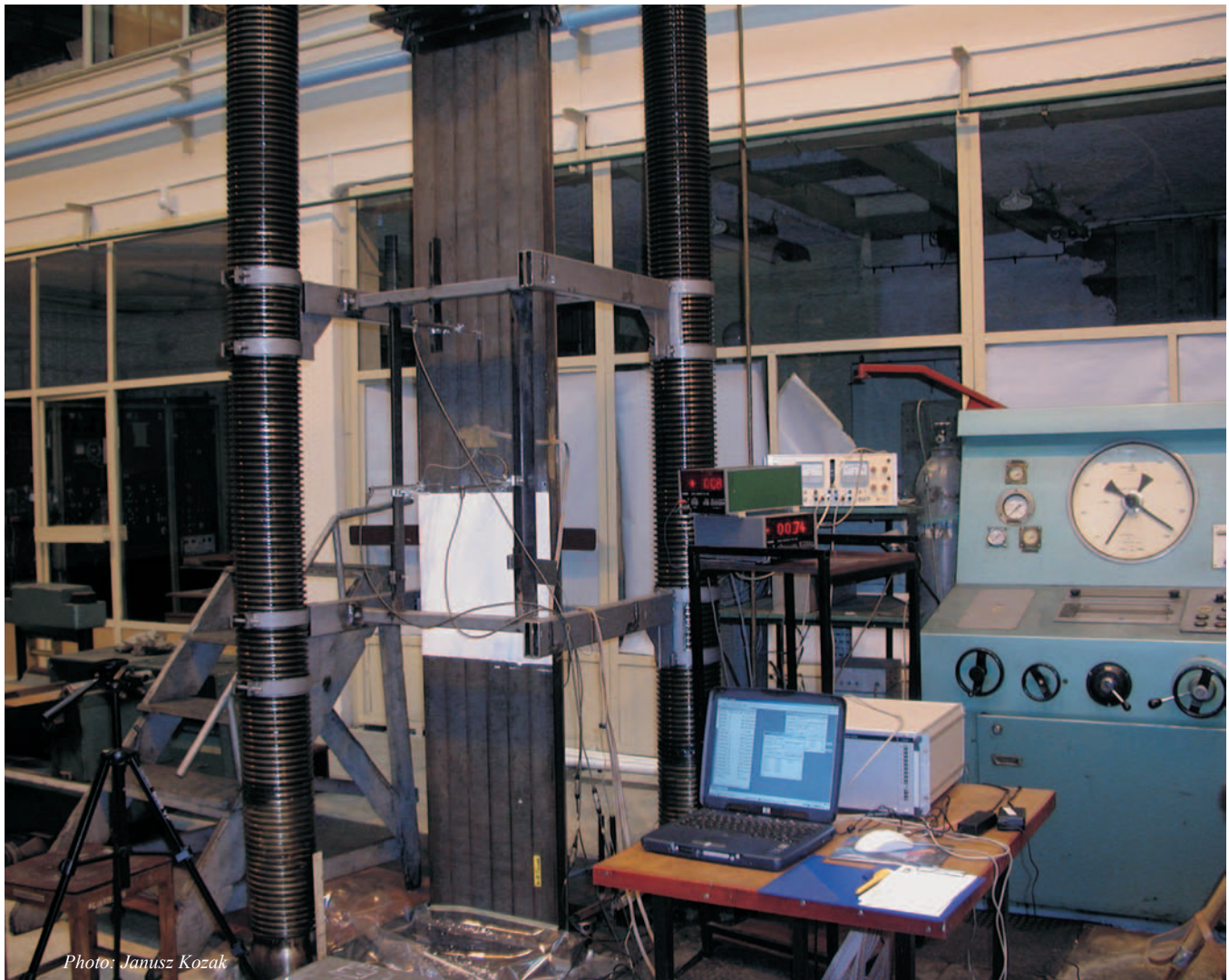

Photo: Janusz Kozak

Sandwich panel model at buckling test stand.