

ANALYSIS OF RELIABILITY OF REDUNDANT SHIP POWER PLANTS

Jacek Rudnicki

*Gdansk University of Technology
ul. Narutowicza 11/12, 80-950 Gdańsk, Poland
tel.: +48 58 3472430, fax: +48 58 3472430
e-mail:jacekrud@pg.gda.pl*

Abstract

This paper presents possible applications of the theory of semi-Markovian processes to determination of reliability characteristics of complex propulsion systems of a given degree of redundancy. Based on a selected example system, a reliability model has been proposed in the form of a stochastic process of discrete states and continuous with time. On the basis of the limit distribution of the process practical aspects of using the reliability indices obtained from the model in question are shown.

Keywords: *reliability, redundancy, semi-Markovian processes, ship power plant*

1. Introduction

Regardless of the reliability level of every power plant, planned in its design stage and achieved in its manufacturing stage, various external and internal factors affect its functional subsystems; the factors cause irreversible degradation processes which result in technical state changing and usually in gradual worsening operational characteristics. Hence in the subsystems failures of their components will appear, moreover the process of occurrence of the failures cannot be precisely described as the affecting factors are of random character [1, 2].

In the case of sea-going ship the above mentioned such change of technical state into that belonging to one of the subsets of unwanted states may cause a hazard not only to the power plant but also the whole ship which may meet with a serious casualty including sinkage - in the extreme case of loss of ability to motion and course-keeping in heavy weather conditions [3].

Intensive development of sea shipping, growing number of ships and ship traffic rate as well as variety of tasks performed by them create real hazards to man and the environment.

Scale of the hazards and trends in that domain can be observed in various reports and analyses published by special organizations worldwide. The institutions first of all deal with the entities a risk to which defined as [6]:

$$RI = FR \times CSQ, \quad (1)$$

where:

RI – risk,

FR - the *frequency* of a potential undesirable event is expressed as events per unit time, usually per year,

CSQ - *consequence* can be expressed as the number of people affected (injured or killed), property damaged, amount of spill, area affected, outage time, mission delay, dollars lost, etc.

is the greatest.

Many statistical reports published by IMO show that a great number of ship accidents take place, e.g. 119 accidents, including 26 serious ones, of passenger ships occurred in the years 1999 – 2006 [9]; however the shipping of oil and its products seems to be the crucial issue today.

It can be exemplified by the reports of ITOPF Ltd (*The International Tanker Owners Pollution Federation*) dealing with the above mentioned problems on tankers. The data presented by the ITOPF (Fig. 1), which concern oil pollution from tankers, show that during about 30 years the average number of large spills decreased almost seven times, however the situation can be hardly deemed satisfactory

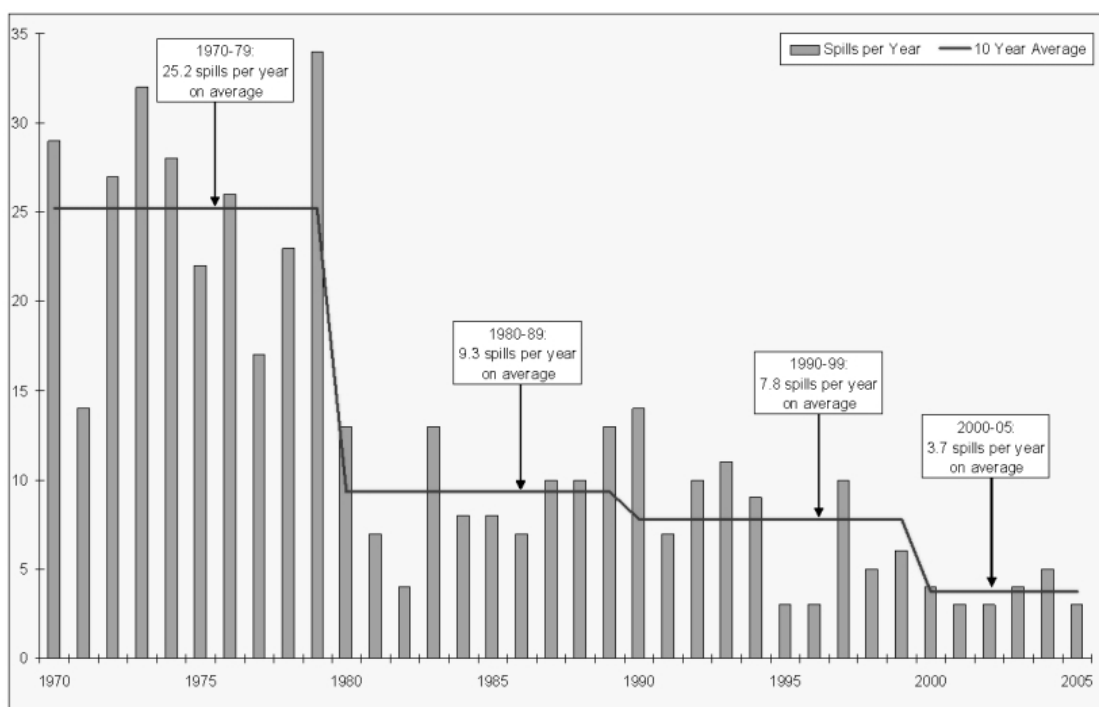

Fig. 1. Numbers of Spills over 700 tonnes [10]

Analyzing the causes of tanker accidents (Fig. 2) one can observe that about 20% of accidents have been still caused by power plant failures in spite of the obtained technological development.

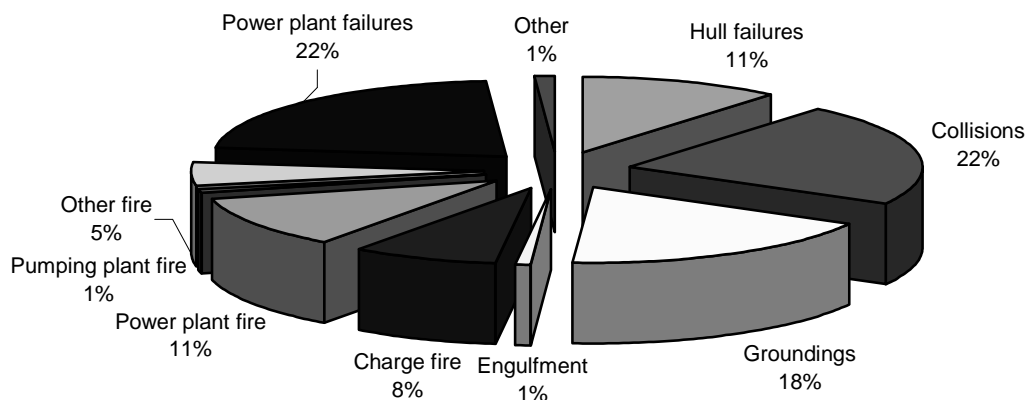

Fig. 2. Incidence of tankers by Causes [10]

The situation resulted in that ship classification societies introduced many stricter requirements for design solutions of propulsion systems on sea-going ships, which result - on the one hand - in risk lowering by decreasing occurrence probability of ship's disability, and - on the

other hand - in appearance of unusual design solutions of propulsion systems on ships of a given class.

2. Propulsion systems of a given redundancy degree

Tankers exemplify the type of ships to which the above described tendencies relate especially distinctly.

On tankers the direct propulsion system with one slow-speed diesel engine is most often applied. Most ships of the kind are still so built as to comply with a minimum of the requirements of legal acts in force (a.o. MARPOL 73/78 Convention), which first of all results from economical reasons [7].

However in recent years, often and often appear real and conceptual technical solutions in which the above presented principle is not obeyed any longer. It can be observed very distinctly in the case of propulsion systems on shuttle tankers. Their operation specificity consisting first of all in precise positioning the ship during oil loading operation at open sea, resulted in that multi-engine propulsion systems became prevailing design solution on such ships.

An example of the evolution of design solutions of propulsion systems on tankers is the unique solution applied on the VLCC tankers of STENA V-MAX type [8]. The propulsion system of the tanker of 333 m in length and design deadweight of 269 000 t is composed of two identical propulsion units located in separate engine rooms. The schematic diagram of the system is presented in Fig. 3.

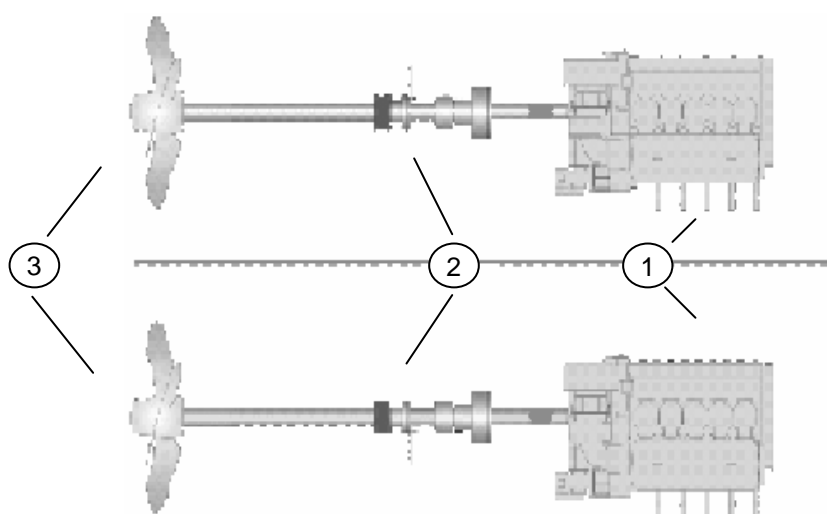

Fig. 3 Schematic diagram of the propulsion system of the crude oil tanker STENA V-MAX : 1 –7S60ME-C MAN B&W main engines, 2- shaft lines, 3 – screw propellers

Another example of the presented approach is the propulsion system installed on a series of tankers intended for operating in Arctic conditions, ordered by the Sovcomflot, a Russian shipowner, in the South Korean shipyard Samsung Heavy Industries Shipbuilding & Offshore Division [11].

Design solution of the propulsion system to be installed on each of 5 tankers of 257 m in length and design deadweight of 70000 t (presented in Fig. 4) is the typical diesel - electric propulsion system which consists of 4 electric generating sets and two azimuthing podded propellers developing 20 MW output power in total.

The design solution following that on the ships to which safety requirements are much more stringent, e.g. passenger cruisers or ice breakers , confirms the existing trends indirectly.

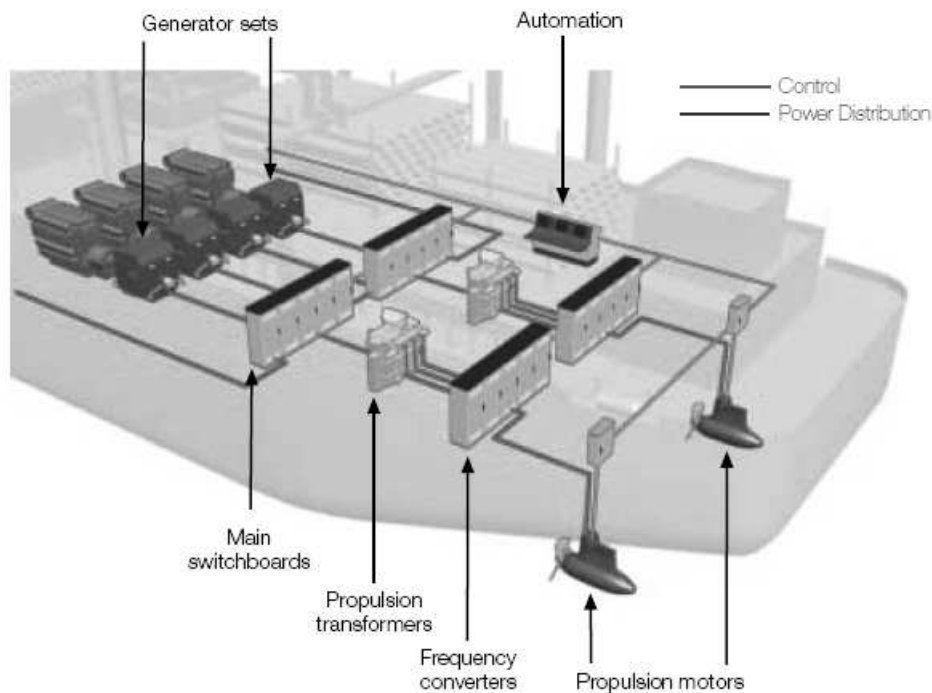

Fig. 4 Schematic diagram of the diesel-electric propulsion system on shuttle tanker [11]

3. Reliability analysis of redundant propulsion systems

Analysis of redundant propulsion systems becomes especially useful and effective when functional reliability models based on the theory of stochastic processes is applied.

Use of the theory of stochastic processes makes it possible to resign from the assumption on two-state character of the process of technical state changing of propulsion system's subsystems and elements, and on the splitting of the space S of possible states into a countable and finite number of subspaces differently distant from the extreme set of initial states [4].

Therefore the assumption on multi-state character is crucial in building functional reliability models. It makes it possible to separate, within the set of distinguished states, several states of different degree of serviceability as well as several unserviceability states (in contrast to most classical models) and to attribute renewability, an important feature which characterizes machines and mechanical devices, to the model.

It is specially important in the case of ship propulsion system of a given degree of redundancy as, being a complex technical object, it may fail in many ways, at different probability values and with various consequences corresponding with a given operational reliability.

In functional aspect the process of operation constitutes that of simultaneous changing both technical and operational states which, being mutually dependent, simultaneously occur during phase of operation [2].

In that case the stochastic processes having discrete set of distinguished states and continuous duration time are suitable to model the technical state changing, crucial from the point of view of reliability and durability. Elements of the set of distinguished technical states, $S = \{s_i; i=1, 2, 3, \dots, I\}$ are values of the process $\{W(t); t \geq 0\}$ which is formed by the successively occurring states $s_i \in S$, being in mutual cause-effect relationship [4].

Elaboration of a functional reliability model makes it possible to determine probabilistic characteristics of real reliability features of practical importance, e.g. for operational decision making with the use of statistical theory of decisions [2].

The above presented example of the shuttle tanker's propulsion system, shown in Fig. 4, has been taken into consideration in this work. Its simplified functional diagram is presented in Fig. 5.

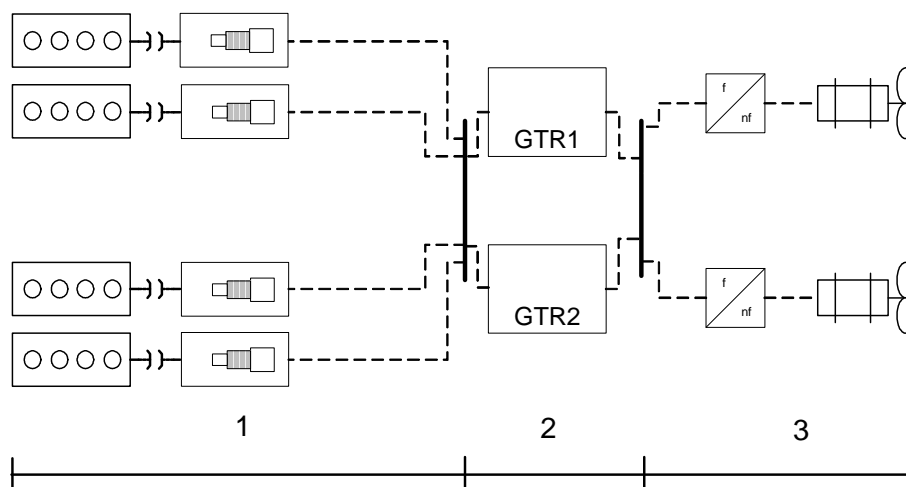

Fig. 5 Functional diagram of the diesel-electric propulsion system on shuttle tanker: 1 – electric power plant together with power transmission system, 2 – electric energy distribution system, 3 – units of podded azimuthing propellers

It can be assumed that for the presented propulsion system a model of technical state changing process – crucial for power plant reliability and durability – can be the stochastic process $\{W(t) : t \in T\}$ of discrete set and continuous duration time and of the following successively occurring distinguished states:

$$S = \{s_i ; i = 1, 2, 3, 4, 5, 6, 7\} \quad (2)$$

which can be interpreted as follows:

- s_1 – full serviceability state of the system;
- s_2 – partial serviceability state of the system due to not quite full serviceability of electric power plant (e.g. full unserviceability of one out of four electric generating sets);
- s_3 – task unserviceability state of the system due to full unserviceability of electric power plant (full unserviceability of all four electric generating sets);
- s_4 – partial serviceability state of the system due to not quite full serviceability of electric distribution system (e.g. full unserviceability of one out of two main switchboards);
- s_5 – task unserviceability state of the system due to full unserviceability of electric power distribution system (full unserviceability of both main switchboards);
- s_6 – partial serviceability state of the system due to not quite full serviceability of podded propellers system (e.g. full unserviceability of one out of two frequency converters);
- s_7 – task unserviceability state of the system due to full unserviceability of podded propellers system (full unserviceability of both podded propellers).

The initial distribution of the process, p_i

$$p_i = P\{W(0) = s_i\}, s_i \in S; i=1, 2, 3 \quad (3)$$

should be represented as follows:

$$p_1 = P\{W(0) = s_1\} = 1, p_i = P\{W(0) = s_i\} = 0 \text{ dla } i = 2, 3, \dots, 7 \quad (4)$$

as assumed that at the initial instant of operation ($t = 0$) the system in question being a functional subsystem of the ship, has to be in the state s_1 .

Since certain redundancy is applied to the system in question it can be assumed that from practical point of view the process of passing in one step from the full serviceability state s_1 to any of the distinguished states of full unavailability, s_3, s_5 or s_7 , is not possible. Hence the functional matrix of the process, $Q(t)$, whose elements are conditional probabilities of passing the process from the state i to state j during time not longer than t [4] can be expressed as follows:

$$Q(t) = \begin{bmatrix} 0 & Q_{12} & 0 & Q_{14} & 0 & Q_{16} & 0 \\ Q_{21} & 0 & Q_{23} & 0 & 0 & 0 & 0 \\ Q_{31} & Q_{32} & 0 & 0 & 0 & 0 & 0 \\ Q_{41} & 0 & 0 & 0 & Q_{45} & 0 & 0 \\ Q_{51} & 0 & 0 & Q_{54} & 0 & 0 & 0 \\ Q_{61} & 0 & 0 & 0 & 0 & 0 & Q_{67} \\ Q_{71} & 0 & 0 & 0 & 0 & Q_{76} & 0 \end{bmatrix} \quad (5)$$

In the case of ship main engine, for the above presented set of state classes, the graph of changing the states of the process $\{W(t): t \in T\}$ can be drawn, as follows:

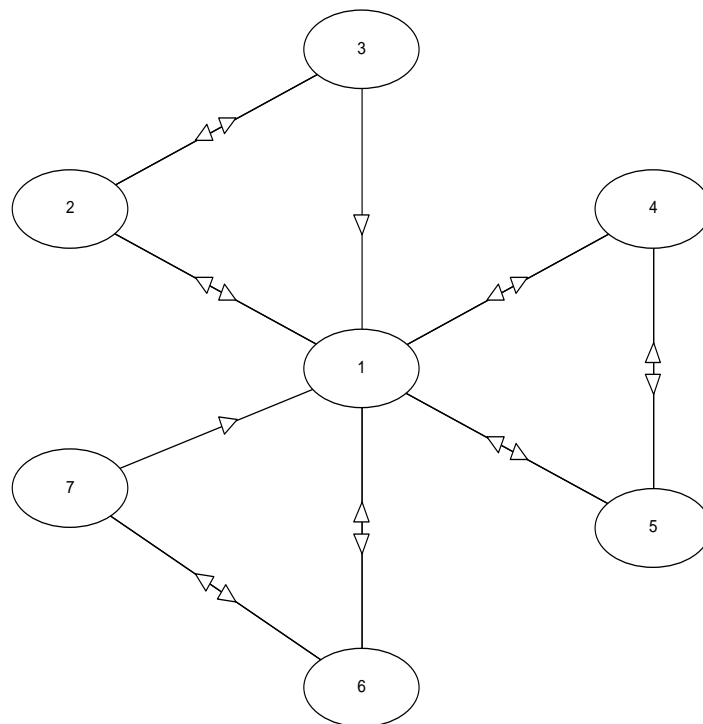

Fig. 6 The graph of changing the states of the process $\{W(t): t \in T\}$

The use of the relation [4]:

$$Q_{ij}(t) = p_{ij} \cdot F_{ij}(t) \quad (6)$$

where:

p_{ij} – probability of passing from the state s_i to the state s_j of Markovian chain inserted into semi-Markovian process, ($i, j = 1, 2, \dots, 7 \ i \neq j$), whereas to assess the particular probabilities p_{ij} , is the most convenient to take the following value of the statistic P_{ij}^* (on the basis of empirical investigations):



$$p_{ij}^* = \frac{n_{ij}}{\sum_j n_{ij}} \quad (7)$$

where:

n_{ij} – number of transitions of the process from the state s_i to the state s_j ($i, j \in S, i \neq j$),
 $F_{ij}(t)$ – cumulative distribution function of the random variable T_{ij} which represents duration time of the process state s_i provided that the state s_j will be next one;
 makes it possible to determine analytical function forms of particular elements of the functional matrix (5) of the process. Fulfillment of the showed conditions determines entirely the considered semi - Markovian process and thus enables to determine also all necessary reliability characteristics.

The limit distribution of the process $\{W(t): t \in T\}$ is undoubtedly one of the most important characteristics because of long time of realization of the propulsion system tasks.

The further part of this paper, as its volume is limited, concerns only the above mentioned distribution.

3. Limit distribution of the process $\{W(t): t \in T\}$

Knowing the 1st order moment of the random variables T_i (expected values) one is able to determine relatively easily the limit distribution of the process (not being forced to solve a set of Volterra's integral equations of 2nd kind , that appears very troublesome in some cases).

For the model in question the distribution interpreted by means of the formula [4]:

$$P_j = \lim_{t \rightarrow \infty} P\{W(t) = s_j\}; \quad s_j \in S, j = \overline{1,7} \quad (8)$$

can be determined from the following relationship [4]:

$$P_j = \frac{\pi_j E(T_j)}{\sum_{k=1}^7 \pi_k E(T_k)}; \quad j = 1, 2, 3, 4, 5, 6, 7 \quad (9)$$

where the distribution $\pi_j, j = 1, 2, 3, 4, 5, 6, 7$ is limit one for the Markovian chain inserted into the process $\{W(t): t \geq 0\}$ ($j \in S$). The limit distribution of the process $\{W(t): t \in T\}$ can be determined from the set of equations [4]:

$$\left[\begin{array}{cccccc} 0 & p_{12} & 0 & p_{14} & 0 & p_{16} & 0 \\ p_{21} & 0 & p_{23} & 0 & 0 & 0 & 0 \\ p_{31} & p_{32} & 0 & 0 & 0 & 0 & 0 \\ p_{41} & 0 & 0 & 0 & 0 & 0 & 0 \\ p_{51} & 0 & 0 & p_{54} & 0 & 0 & 0 \\ p_{61} & 0 & 0 & 0 & 0 & 0 & p_{67} \\ p_{71} & 0 & 0 & 0 & 0 & p_{76} & 0 \end{array} \right] = [\pi_1 \ \pi_2 \ \pi_3 \ \pi_4 \ \pi_5 \ \pi_6 \ \pi_7] \quad (10)$$

$$\pi_1 + \pi_2 + \pi_3 + \pi_4 + \pi_5 + \pi_6 + \pi_7 = 1$$

By solving the set of equations (10) the following relationships assessing the limit distribution of the process $\{W(t): t \in T\}$, can be achieved:

$$P_1 = \frac{(1 - p_{23}p_{32}) \cdot (p_{45}p_{54} - 1) \cdot (p_{67}p_{76} - 1) \cdot E(T_1)}{H} \quad (11)$$

$$P_2 = \frac{(p_{67}p_{76} - 1) \cdot (p_{45}p_{54} - 1) \cdot p_{12} \cdot E(T_2)}{H} \quad (12)$$

$$P_3 = \frac{(p_{67}p_{76} - 1) \cdot (p_{45}p_{54} - 1) \cdot p_{23}p_{12} \cdot E(T_3)}{H} \quad (13)$$

$$P_4 = \frac{(p_{67}p_{76} - 1) \cdot (p_{23}p_{32} - 1) \cdot p_{14} \cdot E(T_4)}{H} \quad (14)$$

$$P_5 = \frac{(p_{67}p_{76} - 1) \cdot (p_{23}p_{32} - 1) \cdot p_{14}p_{45} \cdot E(T_5)}{H} \quad (15)$$

$$P_6 = \frac{(p_{23}p_{32} - 1) \cdot (p_{45}p_{54} - 1) \cdot p_{16} \cdot E(T_6)}{H} \quad (16)$$

$$P_7 = \frac{(p_{23}p_{32} - 1) \cdot (p_{45}p_{54} - 1) \cdot p_{16}p_{67} \cdot E(T_7)}{H} \quad (17)$$

where:

$$H = (p_{45}p_{54} - 1) \cdot (p_{67}p_{76} - 1) \cdot [E(T_1)(1 - p_{23}p_{32}) + E(T_2)p_{12} + E(T_3)p_{23}p_{12}] + \\ + (p_{23}p_{32} - 1) \cdot (p_{67}p_{76} - 1) \cdot [E(T_4)p_{14} + E(T_5)p_{14}p_{45}] + \\ + (p_{23}p_{32} - 1) \cdot (p_{45}p_{54} - 1) \cdot [E(T_6)p_{16} + E(T_7)p_{16}p_{67}] \quad (18)$$

where:

P_1, P_2, \dots, P_7 - probabilities that the process $\{W(t): t \in T\}$ will find itself in the states : s_1, s_2, \dots, s_7 , respectively ;

$E(T_1), E(T_2), \dots, E(T_7)$ - expected values of duration time of the states : s_1, s_2, \dots, s_7 , respectively

The probabilities determined by the formulae (11), (12), (14), (16) are crucial for the operational subsystem (SU) as they characterize probabilistic possibilities of application of the system to a given operational system (SE) provided that it is in the state of full or partial serviceability.

Practical use of the probability values determined by the relations (11 ÷ 17) depends of course on a given decision situation. One of numerous possibilities of the kind is to apply the FTA method (Fault Tree Analysis) [5, 6] for determining the occurrence probability of an unwanted situation.

The example fault tree (no. 1) for the top event : „ limited ability to motion and manoeuvring ” is presented in Fig. 7.

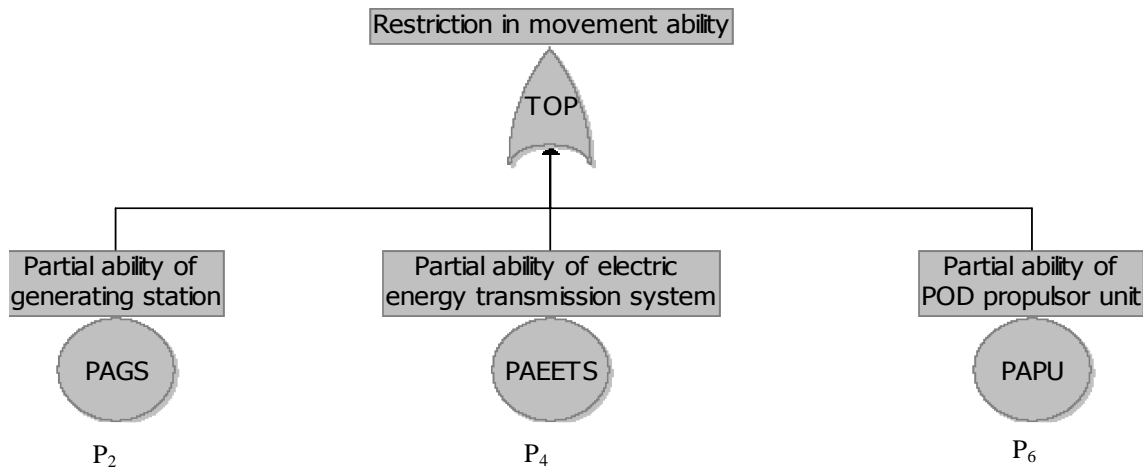

Fig. 7 Fault tree no. 1

To perform a quantitative analysis of the considered sequence of events leading to occurrence of the top event „TOP” is possible by making use of the probabilities P_2 , P_4 and P_6 determined by the relations (12), (14) and (16).

Another example showing practical usefulness of the presented approach may be the situation in which occurrence probability of partial serviceability state together with limit conditions, is considered.

If the above presented top event is taken into consideration but under assumption that the full serviceability state of both azimuthing propeller systems is required then - by using the FTA method - the considered sequence of events can be expressed as follows (fault tree no. 2 – Fig. 8):

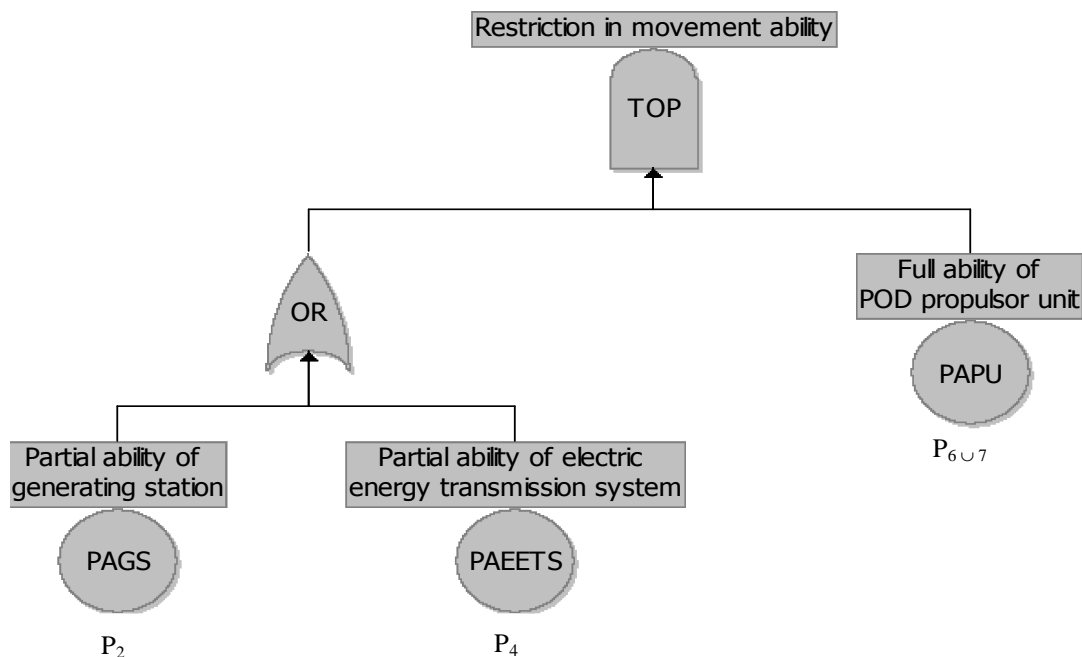

Fig. 8 Fault tree 2

The sequence of events can be quantitatively analyzed by using values of the probabilities P_2 , P_4 determined by the relations (12) and (14), as well as the probability $P_{6 \cup 7}$ which, under the probability feature, can be expressed as:

$$P_{6 \cup 7} = 1 - (P_6 + P_7) \quad (19)$$

where:

$P_{6 \cup 7}$ – probability of the event that the state s_6 or s_7 will not occur

4. Summary

The models elaborated with the use of the theory of stochastic semi-Markovian processes (in particular cases – theory of Markovian processes) seem to be very useful for investigating the reliability of complex technical systems such as the considered propulsion systems of a given degree of redundancy.

The fundamental assumption taken into account in designing such systems, that apart from the full serviceability state a few partial serviceability states must take place in them , indicates in a natural way that the described stochastic processes are equivalent to reliability models.

The practically useful complex description of reliability features of ship power plant (in the considered case – the propulsion system) can be made on the basis of one versatile model. Hence during modeling the process of ship power plant operation it would be usually not necessary to consider various models of a different structure and complexity, which is very important in an utilitarian aspect as it greatly facilitates elaboration of a ready- for- use tool for aiding the process of decision making by the operator..

References

- [1] Birolini, A., *Reliability Engineering. Theory and Practice*, Springer – Verlag, Berlin – Heidelberg New York 1999.
- [2] Girtler, J., *Możliwości zastosowania i przydatność procesów semimarkowskich jako modeli procesów eksploatacji maszyn*, Zagadnienia Eksploatacji Maszyn, Kwartalnik Z.3, Polska Akademia Nauk, Warszawa 1996.
- [3] Girtler, J., Kuszmider, S., Plewiński, L., *Wybrane zagadnienia eksploatacji statków morskich w aspekcie bezpieczeństwa żeglugi*, Wyższa Szkoła Morska, Szczecin 2003.
- [4] Grabski, F., *Teoria semimarkowskich procesów eksploatacji obiektów technicznych*, Zeszyty Naukowe Akademii Marynarki Wojennej, nr 75A, Gdynia 1982.
- [5] Modarres, M., *What Every Engineer Should Know About: Reliability and Risk Analysis*, Marcel Dekker, New York 1993.
- [6] Smith, D. J., *Reliability, Maintainability and Risk. Practical Methods for Engineers*, Butterworth –Heinemann Linacre House, Oxford 2001.
- [7] Waters, J.K., Mayer, R.H., Kriebel, D.L., *Shipping Trends Analysis*, Department of Naval Architecture and Ocean Engineering United States Naval Academy, Annapolis 2000.
- [8] <http://www.concordia-maritime.se/eng/fleet/vmaxmicrosite/tech/>
- [9] <http://gisis.imo.org/Public/ISPS/Default.aspx>
- [10] <http://www.itopf.com/stats.html>
- [11] <http://www.sovcomflot.ru/>

