



Journal of POLISH CIMAC

Faculty of Ocean Engineering & Ship Technology
GDAŃSK UNIVERSITY OF TECHNOLOGY



THE USE OF ACOUSTIC EMISSION TO IDENTIFICATION DAMAGES BEARINGS THE MAIN AND CRANK ENGINES ABOUT THE AUTOMATIC IGNITION

Jerzy Girtler, Wojciech Darski, Gdansk University of Technology,
Artur Olszewski, Gdansk University of Technology, *Faculty of Mechanical Engineering*,
Ireneusz Baran, Marek Nowak, Cracov University of Technology, *Department of
Mechanical, Institute M6*

*Gdansk University of Technology
Faculty of Ocean Engineering & Ship Technology
Department of Ship Power Plants
Ph. (=48 58) 347 – 24 – 30
FAX (+48 58) 347 – 19 – 81
e-mail: jgirtl@pg.gda.pl*

Abstract

The article describes the laboratory tests, which make the first stage of the study concerning the use of the AE method to determine the technical state of the slide bearings in engines with self-ignition. The aim of the present tests was to compare the recorded signals in relation to the technical state of the material of the bearing bush and to check the possibility of using the AE method in determining the transition moment from the fluid friction into the semi-dry friction in the bearing and signaling the first micro-defects of the material of the bearing bush. The experiment has not solved the problem, but they are of a development character and will be continued in the nearest future.

Keywords: *Frequency analysis, slide bearing, friction factor, bearing bush.*

1. INTRODUCTION

Their bearings frequent damages undergo in the exploitation of engines about the automatic ignition [13, 15]. Prevention the damages of these bearings requires the uses of the diagnostics [9, 12, 15]. In the diagnostics of the bearings of combustion engines, especially shipping, the credibility of the diagnosis essential is. He from introduced in publications [5, 7, 8, 9] conditions of functioning every system diagnosing (*SDG*) of the any engine about the automatic ignition results, that the credibility of the diagnosis depends from:

- the condition technical *SDG*, and now from the possibility of his damage,
- possibility of appearing the conditions of the engine about the automatic ignition as the system diagnosed (*SDN*) not considered in the diagnostic task (*ZD*),
- the possibility of changes (especially random) the vector of the power supply (*Z*) and the vector of steering (*E*) and the property of random disturbances (*N*), as a result of what remembers *Z*, *E*, *N* can be known while diagnosing the condition *SDN*,
- the sensibility *SDG* on the change *Z* and *E* and the existence *N*.

The credibility of the diagnosis about the state has the technical or energetic engines about the ignition automatic principal influence on the undertaking rational decisions, and the same on the efficient working of this kind of engines who the assurance makes possible of the desirable course of the process them the exploitation. This results from this that the diagnosis makes up the basic component of any working, not only exploitational, but also projects (in this constructional), technological etc. [6, 7]. The study of the credible diagnosis marks unambiguous identifying the condition of the given engine of the combustion system diagnosed (SDN), and the same recognition potential his property. Because of this, that the guilds SDN are changing random, so the identification of the condition of this system is only approximate which means that diagnosis about this will stand up he is credible, but in the definite degree.

You should now, as the attribute of the diagnosis, estimate this degree of credibility and aim to enlargement of her value near this [3, 4, 8]. The selection of diagnostic parameters is one of the possibilities of enlarging the diagnosis about the condition of these engines to credibility about the possibly largest diagnostic usefulness. You should doubtless seek such parameters among parameters acoustic vibration and the parameters of the acoustic emission. He marks these parameters as the carriers of information about the technical condition of combustion engines, in the comparison with different diagnostic parameters, about many larger informative capacity and the speed of passing on the information about this state. Preliminary investigations showed that the acoustic emission was however more useful, because he discloses the changes of the condition of the structure of the materials of which the elements of remembered engines are made. This results from this that the acoustic emission (EA) is the result of appearing the springy wave of generated by sudden liberation accumulation energy in the material of the elements of engines. They cause such liberation of energy, e.g.:

- micro slips setting on the border of grains being in micro domain about large tensions reaching the border of the plasticity of the given material,
- the movement of vacancies and dislocation, especially joining oneself and the moving the dislocation,
- formation of micro slots and their propagation in the materials of the elements of engines.

This last cause is the strong source generating EA particularly. He results from this that use in the diagnostics of engines about the automatic ignition of the acoustic emission as the diagnostic signal is necessary. In essential relationship with this become investigations aiming to identification and the opinion of the usefulness of the parameters of acoustic emission in the diagnostics of engines about the automatic ignition. This problem was undertaken in article this in the reference to the main and connecting-rods bearings of this kind of engines.

2. THE CONCEPTION OF THE INVESTIGATION USEFULNESS OF DIAGNOSTIC PARAMETERS EMISSION OF THE ACOUSTIC

In the diagnostics top layer of elements bush of the bearings of sliding engines about the automatic ignition, he can be applied the method of analysis and the opinion of their technical state, in the result of the use of acoustic emission (AE) as diagnostic signal according to pattern introduced on fig. 1.



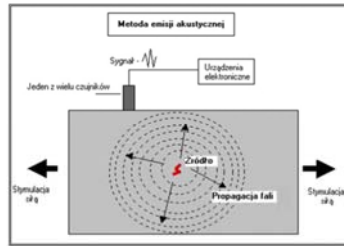

Fig.1. The pattern of spreading springy waves in the solid body [16]

Method this consists in the registration of the course of springy waves (rys.1), being the effect of the liberation of internal springy energy accumulations in material and suitable statistical processing the measured values of the parameters of these waves [1, 2, 10, 15, 17].

The acoustic emission (AE) comes into being in the bearings of combustion engines both in the result of existence micro processes (micro cracks, slides on borders, the movement of vacancies and dislocation) how and in as a result of macro phenomenon (macro cracks, considerable slackness), the connected with the superficial and volumetric waste elements (bearing bush and shaft neck) of these bearings.

The advantage of the method of AE in the use to the diagnostics this first of all the possibility of the registration of signals low energy - consuming coming into being beyond the transducer, what he first of all allows to detect the infringement of the cohesion of the layers of top materials, from which the elements of the bearings of combustion engines are made.

The possibility the registration parameters AE generates by he depends sliding bearings remembered engines on tenderness, resolution and the capacity of the measuring apparatus. You should also have this on the attention that the method of EA requires the not only suitable apparatus, but and applications can process and analyses the huge quantity of data got during the registration of signals [2, 14]. The temporary difference of the attainment of the signal from the source AE to individual sensors makes possible situating this source. In the analysis AE as the change of amplitude and energy in the course among individual sensors the diagnostic signal essential is [10, 15].

They infringement of the cohesion of the top layer of the elements of bearings in the scale micro are detected on long before extensive infringement of this cohesion (damage, in this destruction). Should affirm near this, that deforms (deforming) and they are the cracking the material be sure basic sources AE, but also the processes of corrosion, erosion, frictions and different, causing waste (both superficial as and volumetric) they the elements of sliding bearings also give the perceptible and characteristic growth of this kind of signals [1, 11, 15].

The comparison of recorded signals AE was the aim of the investigations whose results are put in this article dependent on the condition of the technical bearing alloy and proof the method AE of to usefulness to:

- the qualification of the moment he in the bearing crosses in the mixed friction in whose smooth friction,
- disclosing the (signaling) of appearing first micro of the damages of the materials of the elements of the bearing.

The position whose pattern was introduced on fig. 2 was applied to the achievement of remembered investigative aims. Position this made possible [14]:

- the change of the value of the rotary speed,
- measurement and the registration of the value of the moment of appearing the mixed friction in the bearing,
- the measurement of the temperature of bearing studied and lubricate oil,
- the obtainment of the repeatability led tests through the use of automatic steering and the acquisition of results,



- the change of the value of the burden transverse strength according to the plan of the experiment.

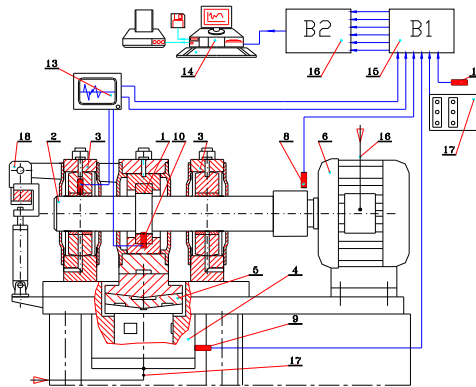

Fig. 2 The investigative position - PG2-1L the suitable parameters of smearing the bearing studied the position were equipped [14]

In the aim of the assurance in independent external current arrangement of smearing with possibility of heating up oil (fig. 3). The ultra thermostat of the type U15C was applied in the arrangement about the capacity 15 l and power 1.75 kW [14, 15]. Heated up to the set temperature oil was pressed to the bearing studied the decentralizing pump plunged in the reservoir ultra thermostat. Oil this flowed down to the reservoir gravitations. Contact thermometer installed in the arrangement of power supply heaters assured the maintenance set value of the temperature of oil.



Fig. 3 The view of the external arrangement of smearing the bearing studied [14]

The investigations AE were led with the use of the system Vallen AMSY-5 (the firm Vallen - Systeme GmbH), and various types of sensors AE (table 1), assuring the registration of signals in the wide strand frequencies [1, 14]. The system Vallen made possible the registration of parameters AE (the moment of appearing the mixed friction, rotary speed, strength burdening bearing, the temperature of oil) simultaneously and the correlation of registered values of remembered parameters. Such sensors AE were applied in investigations how: PAC, PAC + wave-guide, VS 30-V, VS 75-V, VS 150-RIC, VS 150-RIC + wave-guide, VS 375-RIC, SE 45-H. These sensors were fixed on the measuring head of the investigative position and the side surfaces of hydrostatical bearings.

The measurement of the acoustic background was first stage of investigations and the disturbances of generated by the work devices on the investigative position. The schedule of the strands of the frequency of signals registered during these investigations was introduced on fig. 4.



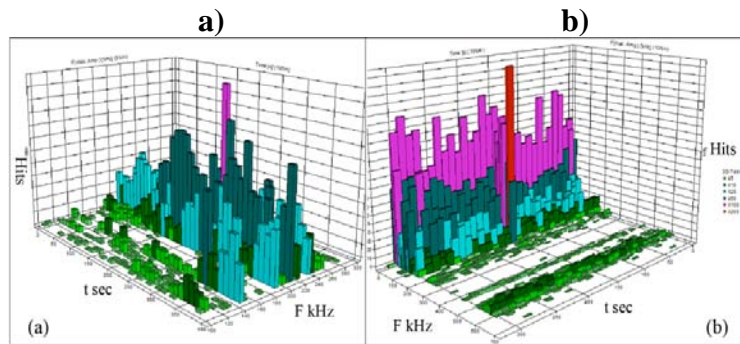

Fig. 4 The schedule of the strands of the frequency of signals registered for broad – gauge sensors: a) the range 100 – 300 kHz, b) the range 20-850 kHz [14]

The conducted frequencies analysis of registered signals AE allowed to the qualification the main strands of disturbances and choice of the frequency of filters the *high pass* and the *low pass* to next measurements in the aim of elimination of disturbances coming from the work of the position of investigative and inside and outside the laboratory [14].

The results of the investigations of bearings with the new pans of the type MB10 (two-ply, overflow 212 -CuPb22Sn) and MB35 (four layers, overflow 331- PbSn10Cu2), with use of the filters of the frequency, near the received conditions of the burden and the rotary speed becomes them left, according to next tests, put in the table 1. The solid rotary speed of the rampart was accepted as exit sizes 1700 rot. /min. the faces and two sizes of the burden of the transverse bearing -1 kN and 2 kN. The settled parameters of acquisition for these conditions of the work of the new bearing made up later the base for the comparison in remaining tests.

In the aim of the comparison of signals AE recorded near the investigation of the new bearing with signals coming from the bearing with simulated damage, measurements of three sliding bearings of the type MB10 were conducted [1, 14]:

- the new bearing bush,
- bearing with openings simulating the local damages of the material bearings bush e.g.: superficial crack or the plucked out particles of the bearing alloy causing disorders of the flow of oil smearing (fig.5),
- the bearing with cut longitudinal and district grooves, simulating the damage of the surface bearings bush in result of transfusion of strange bodies among pan and suppository (fig. 6 and 7).

On the fig.5 was introduced the fatigues damage of the bearing alloy (a) and simulated damage (b). On the fig.6 was introduced in the turn the damage of the surface of the bearing in the result of the transfusion of strange bodies among pan and suppository, and on fig. 7 executed simulated damage similarly as on fig. 5.

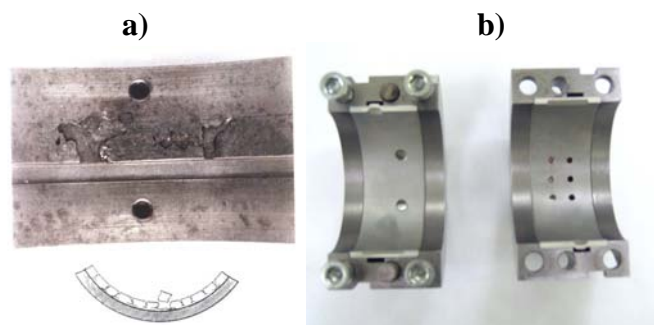

Fig. 5 View bush with the fatigues damages of the bearing alloy: a) the propagation of the cracks of hard basis and crumbling up the particles of the bearing alloy, b) simulated damages in the figure 6-ciu the openings about the diameter $\varnothing = 4$ mm, what 15° [14]

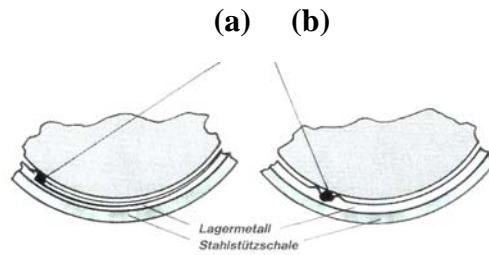

Fig. 6 The pattern of the damages of the sliding surface bearings caused through strange bodies: (a) pumps through grains and the rifling of the sliding surface, (b) polishing shaft neck through grains fixed in the sliding layer [14]

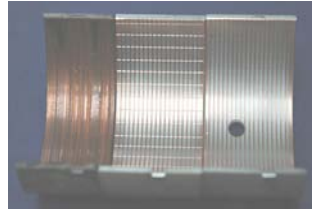

Fig. 7 The view realization of the damages of the surface bearings which can come into being in the result of the transfusion after them of strange bodies [14]

The reports were established in investigations between damages bearings bush of the bearings bush of sliding engines about the automatic ignition, introduced on fig. 5 ÷ 7, and the measures parameters of the acoustic emission (AE).

3. THE RESULTS OF MEASUREMENTS PARAMETERS EMISSION OF ACOUSTIC

During investigations were recorded:

- the counting the events (hits) - the basic parameter of the activity of the source AE,
- quantity exceeds of the level of discrimination (counts),
- the value of the energy of the signal,
- the amplitude of signals,
- RMS - the average square intensity of the signals of the continuous emission - parameter to defining the value of the continuous emission below the threshold of detect ability,
- the burden,
- the moment of the rise of the mixed friction,
- the rotary speed,
- the temperature of bearing and lubricate oil.

Exchanged parameters AE were used to monitoring the technical condition of sliding bearings [11, 15, 16].

Results of registration of value RMS for new bearing and bearings with simulated damages (fig. 5, 6, 7) were introduced on fig. 8, 9 and 10.



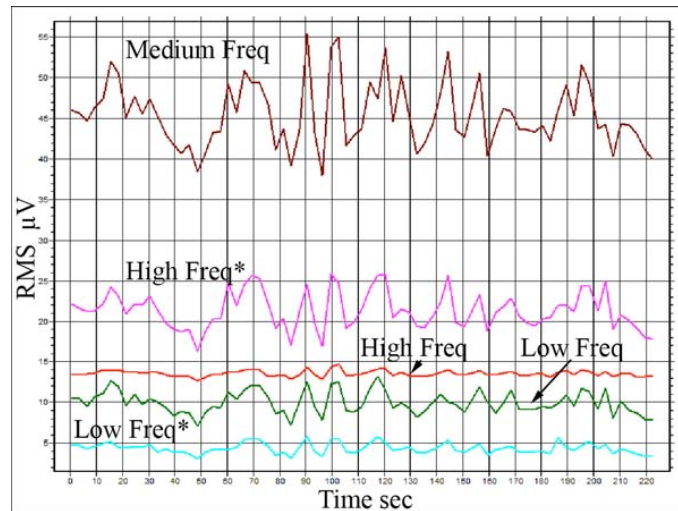

Fig. 8 RMS for the various compartments of the filters of the frequency - the sliding bearing new [14]

The stability of the value (fig.8) steps out for RMS about the high frequency (orange line). You can see the growth of the value RMS AE in all channels for the except of the frequency *low* from the analysis of the data generally *low** and *high**. The value of measurements puts in the table 1 got in channels from low, the central (medium) and high the frequency answering state (generic) the damages of the bearing was introduced on fig. 9 and 10.

Tab.1. RMS in the function of time for the various strands of the frequency [14]

Condition of the bearing	Low [μV]	Low* [μV]	Medium [μV]	High [μV]	High* [μV]
New	10	4	46	13	27
Holes	27	3	67	27	23
Grooves	34	8	105	0	47

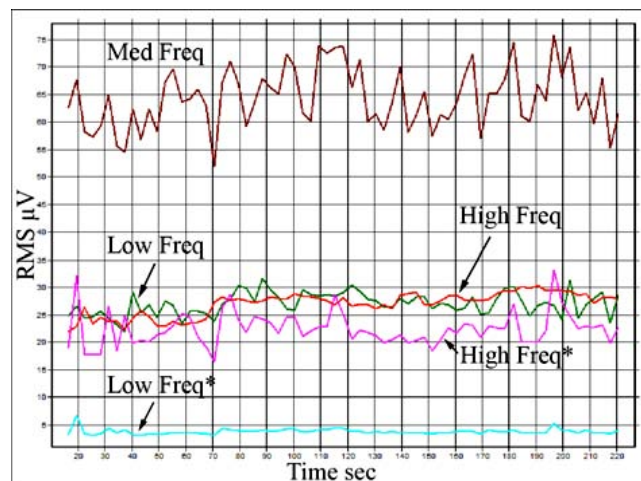

Fig. 9 RMS for the various compartments of the filters of the frequency - the damage of the type of the fatigues bearing alloy [14]



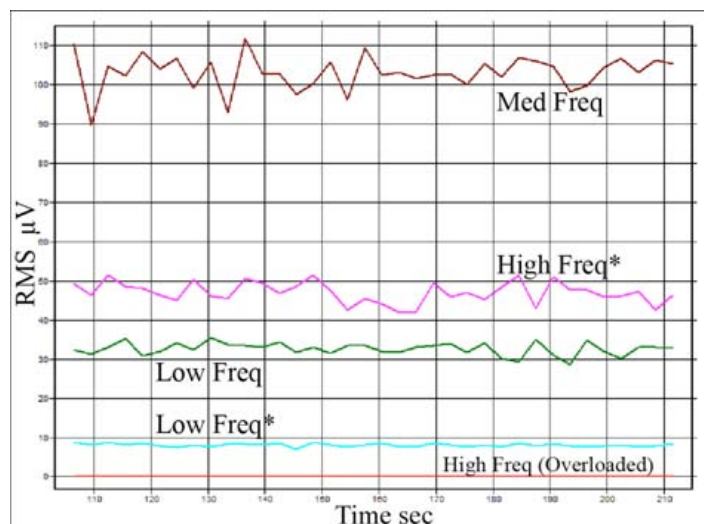

Fig. 10 RMS for the various compartments of the filters of the frequency - damage in the figure furrows of the bearing alloy [14] was introduced

On the fig.11 was introduced the activity of the emission for new bearing and bearing simulating wrench of the particles of the alloy near these alone parameters of the acquisition, near the use of resonance sensors VS75-V and VS150-RIC and frequency filters on measuring channels.

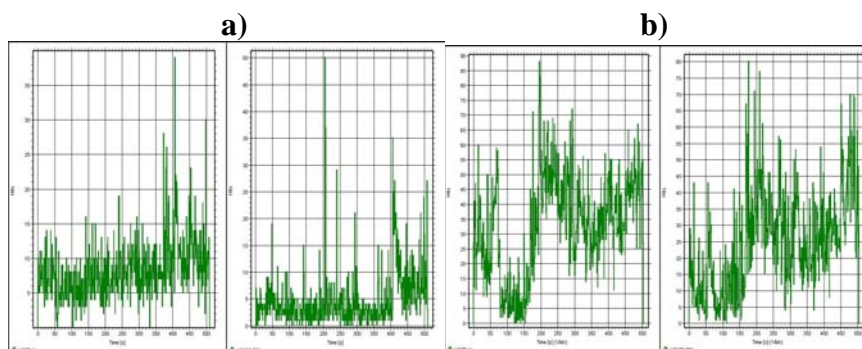

Fig. 11 The parameters AE the activity of the acoustic emission in dependence from the time for the bearing: a) new, b) with opening simulating wrench of the particles of the alloy were recorded [14]

After the serial changes of the rotary speed during the work of the bearing near the solid settled rotary speed 1700 rot./min. the faces and settled burden 2 kN. The example of the single temporary range signals AE were recorded in which, was introduced on fig. 12.

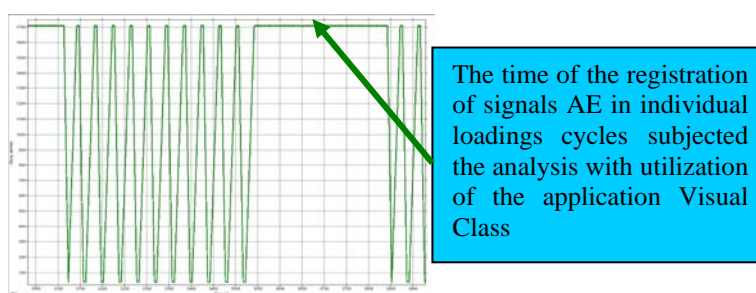

Fig. 12 The example single loading cycle of bearing with the marked range of the time of the registration of signals AE subjected the more far analysis [14] was introduced

On the fig. 13 the sum of registered signals during the work settled. The visible change of the activity of recorded signals on the sensor VS150-RIC, she signaled the change in the work of the bearing. First traces were the cause of the sudden growth of the activity AE (hits) the waste oneself the bearing layer of the bearing.

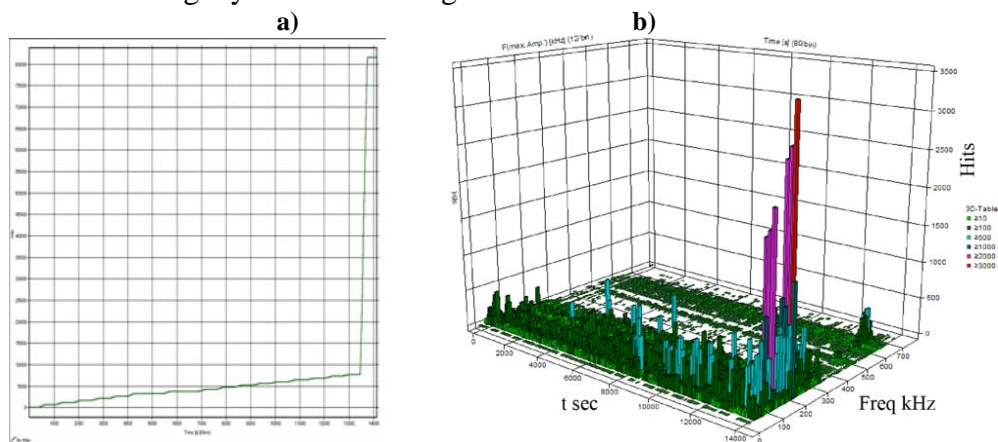

Fig. 13 The results of investigations: a) - the sum of registered events (hits) in the time of the settled work of the bearing, b) - the sum of the schedule of events (hits) in the strands of the frequency [14]

For the example on fig. 14 the condition of the surface of the sliding layer of pans after investigations was introduced

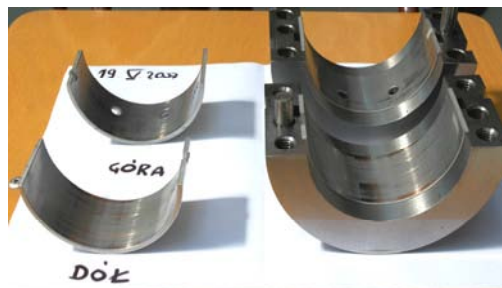

Fig. 14 The view split bearing bushings of the type MB10 and MB35 after investigations visible first traces the waste of the sliding layer [14]

The measurement AE was one of the essential aims of investigations while the disappearance of smooth friction and passage in the mixed friction, that is in the moment of the appearing first contact micro roughness shaft neck from the micro roughness of the pans of the bearing. The methodology of investigations enabling decrease of the coefficient of the friction was worked out in this aim as much as to appearing the contact metallic shaft neck with pans. The value of the rotary speed was reduced during the test near the behaviors of the solid value of pressures gradually. Reducing the value of the rotary speed results in decrease of the thickness of the oil film, what he leads fall of moment of friction generated in bearing (fig. 15, 16) in the consequence. The moreover decrease of the rotary speed results in appearing the contact metallic shaft neck from bearing bush. He appears then the mixed friction, which causes enlargement the value of the moment of the friction in the bearing. The minimum value of the moment of the take measurements friction in the bearing studied answers the moment in which first contact turning shaft neck appears from motionless bearing bush bearing bush and cutting first tops of unevenness in the face of this exactly. The value of this moment grows since this moment.

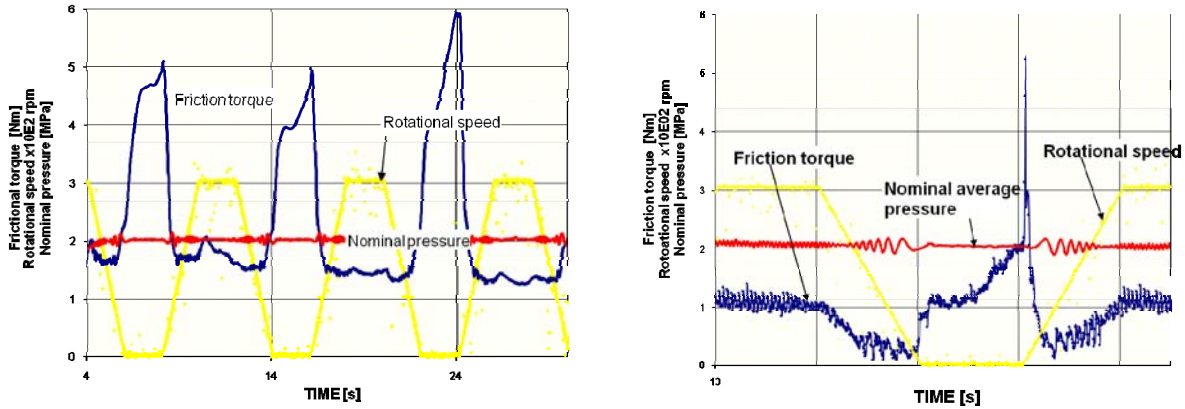

Fig. 15 Result of test in the conditions of the interruption of the smooth friction. Solid nominal pressures [14]

After stopping shaft neck in the bearing the moment of the friction in the bearing bush. Together with from the growth the district speed u the hydrokinetic pressure begins gradually to appear raise the suppository and reducing the number of cut uneven nesses. The coefficient of the friction μ achieving the minimum value in the moment of the achievement of the smooth friction he undergoes the decrease. More far enlarging the rotary speed results in enlargement of the speed of the flow of oil in the crack and enlarging the coefficient of the friction.

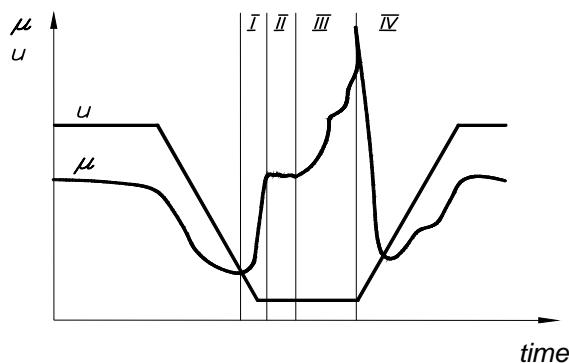

Fig. 16 The graphs $\mu = f_{\mu}(t)$ and $u = f_u(t)$ and the dealt out areas of the coefficient frictions observed during the movement [13]: μ – the coefficient of the static friction, u – the speed district shaft neck of the bearing

Analyzing the shape of the course of the value of the coefficient of the friction μ one can distinguish four characteristic areas as the function of the time (fig.17):

- the area I, II and III in which the growth of the value of the coefficient of friction in the consequence of the worsening conditions of smearing as a result of diminishing the rotary speed follows as much as to the stop of the suppository of the bearing
- area IV, in which in the consequence of the starting and the fall of the value of the coefficient of the friction called out the improvement of the conditions of smearing gradual enlarging the rotary speed follows.

The coefficient of the friction begins his value to grow up together with the growth of the speed rotary shaft neck after the crossing the minimum value. The dependence of the coefficient of the friction represents the profile of the sliding bearing from value forced (rotary speed, nominal pressures) and the stickiness of lubricate oil. Recorded in this time activity AE introduced on rys.17, she signaled getting smaller the coefficient of the friction through the atrophy of the activity of signals AE. Meanwhile the increase coefficient of the

friction between the surface shaft neck and pans, the sudden growth of the value of the parameters of signals AE accompanied.

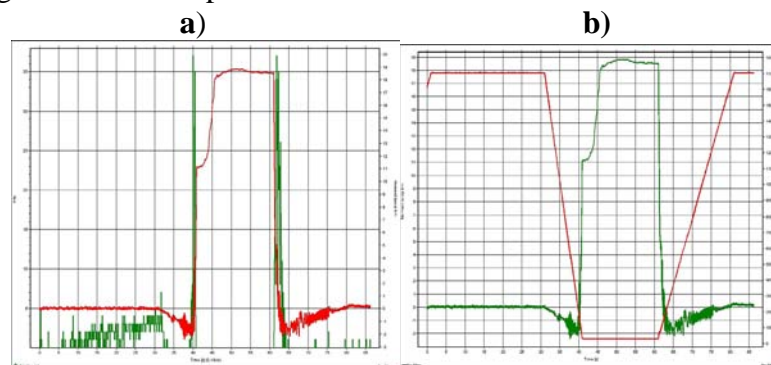

Fig. 17 Turns and the moment of the friction and the activity of signals AE during the change of the kind of the friction in the bearing [1]

On fig.18 the course of parameters as: were introduced additionally the course of the changes of the activity AE - the quantity of events (hits) for the various strands of the frequency. The value of the rotary speed of the rampart is even to null, when the friction achieves the largest value. The activity AE was not recorded in the period, until the rotary speed of the rampart did not reach the value ~ 700 rot./min. faces (fig. 18b).

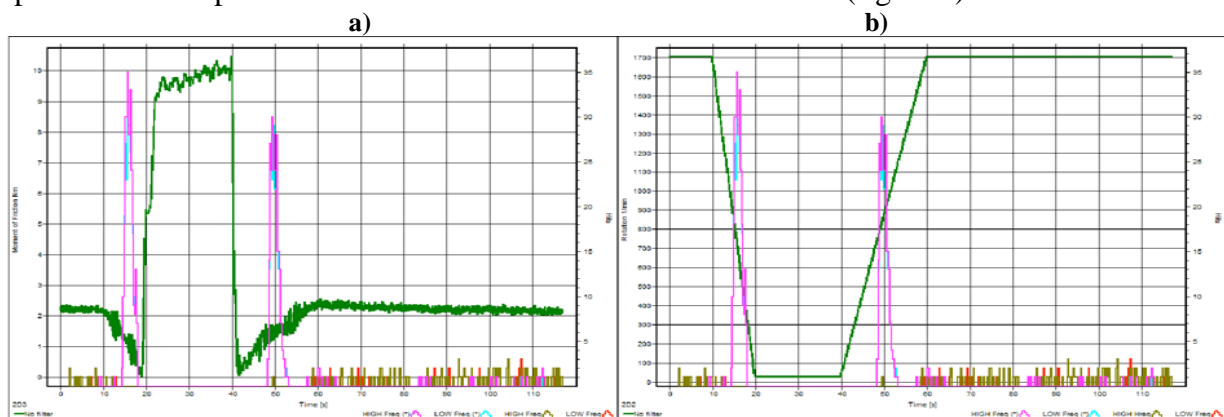

Fig. 18 The change of parameters and activity AE as: a) - the moment of the friction (from the left side) and RPM (from right), b) - RPM (from the left side) and the quantity of events (hits) (from right), during the change of the kind of the friction in the bearing [1]

For the classic hydrokinetic bearing transverse, dependence this illustrates the graph Hersey'a. Example graph such was introduced on fig.19.

Three areas distinguish themselves on graph this:

- the area I - of the smooth friction, area laid on the right from the minimum value of the coefficient of the friction η_s as appointed by λ_a . Area this answers range full smearing of hydrokinetic, in which surfaces sliding shaft neck and bearings bush are separated the comparatively fat layer of grease. Accident from pressures in this layer balances the burden external bearings,
- the area II - on trick from the minimum of the friction ($\eta_e \eta_s$; λ_a) he answers the range mixed friction. The value of the coefficient of the friction together with the diminishing value of the number Hersey'a λ grows in the result of the growing of the friction border part in area this and the diminishing part of the smooth friction in the bearing,

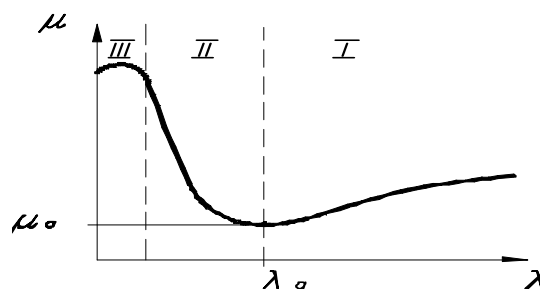

Fig.19 The graph Hersey'a [13]

- the area III – he answers the range border friction, placed on graphs Stribeck-Hersey'a, he is in experimental investigations very difficult to the achievement. Such state to appear can in the bearing, in the whole area of the friction the very thin lubricate film would have to step out about the thickness of line a dozen or so to tens molecules of grease

ATTENTIONS AND CONCLUSIONS

From conducted research. The qualification of disturbances necessary is during the work of the tested combustion engine in more far investigations. Introduced examples from investigations illustrate that the use of the acoustic emission (AE) possible is to the qualification of the technical condition (damage) of sliding bearings. The tenderness of the method AE allows to record in the conditions of laboratory signals AE testifying about the passage from the smooth friction in mixed.

The study should be the next stage of investigations and the construction of the classifiers with utilization of the application Visual Class, being based on the spacious library of measuring data got during executed investigations on the investigative position of the type PG2-1Ł. The classifiers will make possible the identification the signals AE come from damages near the analysis of the phantom of signals AE, received during the investigations of the engine about the automatic ignition in laboratory conditions.

He was notified at the Office Patent Polish Republics in the result of conducted investigations, by the authors of the article, invention pt. *Way and position to construction of the classifiers to the identification of the accident condition of bearings, especially engines about automatic ignition near the use of the acoustic emission as the diagnostic signal.*

REFERENCES

1. Baran I., Nowak M., Darski W.: *Application of acoustic emission in monitoring of failure in slide bearings*. Proceedings of the International Conference on Acoustic Emission. Advances in Acoustic Emission – 2007. The Sixth International Conference on Acoustic Emission ICAE-6, Nevada. U S A, October, pp.155-160.
2. Gill J.D., Rauben R.L., Scaife M., Bron E.R., Steel J.A.: *Detection of Diesel Engine Faults using Acoustic Emission.*, Proc. 2 Conference. Planned Maintenances, Reliability and Quality, 2-3 April, Oxford 1998, pp. 57-61.
3. Girtler J.: *Statistic and probabilistic measures of diagnosis likelihood on the state of self-ignition combustion engines*, Journal of Polish CIMAC. Vol. 2, No 2(2007), pp.57-63.
4. Girtler J.: *Probability measures of likelihood of diagnosis of the technical state of main combustion engines of sea-going ships*. Journal of KONES. Vol. 16, No 2(2009), pp.125-132.



5. Girtler J., Kuzmider S., Plewiński L.: Wybrane zagadnienia eksploatacji statków morskich w aspekcie bezpieczeństwa żeglugi. Monografia. Wyższa Szkoła Morska w Szczecinie, Szczecin 2003.
6. Girtler J.: Zastosowanie bayesowskiej statystycznej teorii decyzji do sterowania procesem eksploatacji urządzeń. Materiały XXII Zimowej Szkoły Niezawodności nt. Wartościowanie niezawodnościowe w procesach realizacji zadań technologicznych w ujęciu logistycznym. SPE KBM PAN, Szczyrk 1994, s.55–62.
7. Girtler J.: *Wiarygodność diagnozy a podejmowanie decyzji eksploatacyjnych*. Materiały Kongresu Diagnostyki Technicznej KDT'96 TII. Zespół Diagnostyki SPE KBM PAN, PTDT, IMP PAN w Gdańsku, Politechnika Śląska w Gliwicach, Politechnika Poznańska, Gdańsk 1996, s.271–276.
8. Girtler J.: *Probabilistic measures of a diagnosis' likelihood about the technical state of transport means*. Archives of Transport, vol. 11, iss. 3-4. Polish Academy of Sciences. Committee of Transport, pp.33–42.
9. Girtler J.: Diagnostyka jako warunek sterowania eksploatacją okrętowych silników spalinowych. Monografia, Studia Nr 28. Wyższa Szkoła Morska w Szczecinie, Szczecin 1997.
10. Malecki I., Ranachowski J.: *Emisja akustyczna, źródła, metody, zastosowanie*. KBN, Warszawa 1994.
11. Ono K.: *Fundamentals of acoustic Emission*. University of California, Los Angeles 1976.
12. Włodarski J. K., Makowski L.: *Sposób i układ do sygnalizacji stanów zagrożenia awaryjnego łożysk silników spalinowych*. Patent nr 112916, 1982.
13. Włodarski J. K.: *Uszkodzenia łożysk okrętowych silników spalinowych*. Wydawnictwo Akademii Morskiej w Gdyni, Gdynia 2003.
14. Darski W., Girtler J.: *Pomiary parametrów emisji akustycznej generowanej przez zmęczeniowe uszkodzenia panwi łożysk MB50, MB02 na stanowisku badawczym SMOK Część VIII (wykonanie pomiarów na stanowisku, opracowanie wyników, wnioski z badań)*". Sprawozdanie z wykonania badań w ramach realizacji projektu badawczego Ministerstwa Nauki i Informatyzacji (nr. 3480/TO2/2006/31) pt.: „Identyfikacja stanu technicznego układów korbowo-tłokowych silników o zapłonie samoczynnym ze szczególnym uwzględnieniem emisji akustycznej jako sygnału diagnostycznego”. Prace badawcze Wydziału Oceanotechniki i Okrętownictwa Politechniki Gdańskiej nr 05/2009/PB, Gdańsk 2008.
15. Girtler J.: Sprawozdanie z realizacji projektu badawczego własnego, Grant Nr N504 043 31/3480 pt. „Identyfikacja stanu technicznego układów korbowo-tłokowych silników o zapłonie samoczynnym ze szczególnym uwzględnieniem emisji akustycznej jako sygnału diagnostycznego”, kierownik projektu: prof. Jerzy Girtler.
16. ASME, Acceptance Test Procedure for Lass II Vessels, Article RT – 6, Section X, Boiler and Pressure Vessel Code (December 1988 Addendum and latter editions).
17. Instrukcja: Course Handbook for SNT-TC-1A Qualification/Certification Course for Acoustic Emission Personal, Level II, Physical Acoustic Corporation 1991.

