

Experimental and theoretical study of dryout in annular flow in small diameter channels

DARIUSZ MIKIELEWICZ*
MICHAŁ GLIŃSKI
JAN WAJS

Gdansk University of Technology, Faculty of Mechanical Engineering, Narutowicza 11/12, 80-233 Gdańsk, Poland

Abstract In the paper the experimental analysis of dryout in small diameter channels is presented. The investigations were carried out in vertical pipes of internal diameter equal to 1.15 mm and 2.3 mm. Low-boiling point fluids such as SES36 and R123 were examined. The modern experimental techniques were applied to record liquid film dryout on the wall, among the others the infrared camera. On the basis of experimental data an empirical correlation for predictions of critical heat flux was proposed. It shows a good agreement with experimental data within the error band of 30%. Additionally, a unique approach to liquid film dryout modeling in annular flow was presented. It led to the development of the three-equation model based on consideration of liquid mass balance in the film, a two-phase mixture in the core and gas. The results of experimental validation of the model exhibit improvement in comparison to other models from literature.

Keywords: Dryout, CHF; Annular flow; Flow boiling

Nomenclature

C – droplet concentration in core
 D – channel diameter
 h – enthalpy
 h_{lv} – latent heat of vaporization

*Corresponding author. E-mail address: dmikiele@pg.gda.pl

G	-	mass velocity
L	-	total length of tube
P	-	pressure
q	-	heat flux
We	-	Weber number
x	-	vapour quality
z	-	distance along the channel

Greek symbols

δ	-	thickness of liquid film
ρ	-	density
μ	-	dynamic viscosity
σ	-	surface tension

Subscripts

c	-	core
cr	-	critical
D	-	deposition
E	-	entrainment
f	-	film
i	-	interface
l	-	liquid
lv	-	liquid-vapour
v	-	vapour
w	-	wall

1 Introduction

Dryout condition represents the breaking of the continuous liquid contact with the heated surface in a flow channel at moderate to high qualities. It follows the gradual decrease of liquid fraction due to evaporation or boiling of the liquid film. At this point, the liquid film at the heated surface dries up, while entrained droplets may still flow in the vapor core. These droplets occasionally hit the heated surface and evaporate. The phenomenon of liquid film dryout in an annular flow typically occurs for flows with medium and high vapor qualities, when moderate values of heat flux are applied to the wall. The sudden decrease of heat transfer coefficient and increase of wall temperature can be observed if liquid disappears from the wall as a result of complete evaporation. In relation to the supplied heat flux the temperature increase may exceed, in some cases, the melting temperature of the tube material. Burnout of the channel wall and the device failure can then happen. Such phenomena are undesirable but may occur in boiling water reactors or steam generators, where water is the working medium.

In the case of low-boiling point fluids the film dryout can also be observed. However in that case it has not such negative consequences as mentioned previously. It does not lead to burnout, because the melting temperatures are not exceeded. This kind of phenomena may appear in refrigeration and air-conditioning units and heat exchangers used to cool the surface, e.g. microchips in electronic applications, micro-channel heat sinks, Qu and Mudawar [1]. In the literature plenty of research works related to the liquid film dryout phenomena in the annular flow can be found. Mainly there are investigations carried out in the conventional channels, however during the last years the phenomena occurring in minichannels attracted also significant interest. Kandlikar [2] defined minichannels as the channels for which the hydraulic diameter is not higher than 3 mm, and the flow structures during boiling are different than in the case of conventional channels. It should be emphasized that in minichannels the heat transfer coefficient is higher, which is related to turbulent flow conditions, limited space for vapor bubble growth and also thinner thermal boundary layer.

Many of the studies reported in literature actually report also the data on dryout. Presented below are the most important ones. Bergles and Kandlikar [3] reviewed the existing studies on critical heat flux in microchannels. They concluded that single-tube critical heat flux (CHF) data are not available for microchannels. For the case of parallel multichannels they noted that all the available CHF data were taken under unstable conditions. The critical condition is the result of an upstream compressible volume instability or the parallel channel, Ledinegg instability. As a result, the CHF values are lower than they would be if the channel flow were kept stable by an inlet restriction at the inlet of each channel. Celata *et al.* [4] basing on the balance of liquid film in the channel, applied a one-equation model due to Whalley *et al.* [5] to determine CHF in small diameter channels. In such model modified were terms related to entrainment and deposition of droplets suspended in the channel core. The deposition term has been modeled in line with the model due to Kataoka and Ishii [6], whereas the entrainment term has been considered in the form of two contributions, namely the term related to droplet entrainment as a result of boiling of liquid; that was modelled in line with the Ueda *et al.* relation [7] and the second term is related to breakup of rolling waves on the film interface. That term was modeled using the Kataoka and Ishii model [6]. The beginning of the annular flow was determined using the Mishima and Ishii [8] relation. The model was tested for 1532 experimental points taken from



Kureta, Lowdermilk and Becker [8] and about 30% error band was encountered for 92% of experiments in the pressure range $P = 0.1\text{--}1.0$ MPa and mass velocity $G = 10\text{--}8200$ kg/m²s in channels with diameters ranging from 1–6 mm. Sedler and Mikielwicz [9] postulated a two-equation analytical model where the mass balance equation in the film is supplemented with the mass balance equation for entrained droplets in the core. Such approach is more general, as two variables, namely the mass velocity of film and mass velocity of droplets are solved by two independent equations. In many approaches to modeling dryout, which are based on a mass balance equation of the film, there can be found a term in which the ratio of entrained droplets with respect to the amount of liquid is used. Such parameters are adjusted based on experimental data. The approach presented by Sedler and Mikielwicz can model directly such term. Originally their approach was to assume that the rate of deposition G_D is proportional to flow rate of entrained droplets in the core, whereas the rate of entrainment was also proportional to the flow rate of liquid in the film. Such assumption enabled to find very simple analytical solution of liquid film flow rate distribution. That distribution was similar in form to the relation determined experimentally by Silvestri (Cumo *et al.* [10]). In a revised approach to that model, Mikielwicz *et al.* [11], new correlations for deposition and entrainment rates together with the amount of heat used for evaporation of film have been used.

Most approaches so far used the mass balance equation for the liquid film with appropriate formulations for the rate of deposition and the rate of entrainment. Examples of such mass balance models are due to Okawa *et al.* [12] and Celata *et al.* [4]. It must be acknowledged that any discrepancy in determination of deposition and entrainment rates, together with cross-correlations between them, leads to the loss of accuracy of model predictions. The fundamental problem with modeling of liquid balance in the film is adequate determination of initial conditions. Such conditions require appropriate mass velocity of liquid droplets in the core G_k as well as the mass velocity of liquid film on the channel wall G_f , at the beginning of annular flow.

In the Department of Energy and Industrial Apparatus the analysis of phenomena occurring in diabatic flows in small diameter channels are under scrutiny for some time now. First studies regarded experimental analysis and mathematical modeling of flow, Klugmann [13], Tesmar [14]. They led to the development of the experimental data base, which was subsequently

used for estimation of heat transfer coefficient and pressure drop in tubular channels of 1.15 mm and 2.3 mm. In the second stage the same experimental setup was used, however it was exposed to some significant modifications. The modern temperature measurement techniques such as infrared camera were applied. It enables fast and precise determination of the location of dryout on the channel wall. The analysis of film dryout phenomenon in the annular flow was carried out, Gliński [15].

In this paper the results of experimental study into dryout for two fluids, namely SES36 and R123, in the channels of 1.15 mm and 2.3 mm, diameter will be presented. The fluid SES36 is mainly dedicated to direct surface cooling systems (e.g. spraying or bath cooling) and also to be applied as a working fluid in the ORC cycle (Organic Rankine Cycle). At the atmospheric pressure its boiling temperature is equal to 36.7 °C. This medium is new and from the authors point of view there is a lack of information connected with its heat transfer performance. The synthetic medium R123 is recommended for the high-temperature cooling systems (e.g. the heat pumps) and also the devices with ORC cycle. At the atmospheric pressure its boiling temperature is equal to 27.5 °C [17]. An attempt was made to correlate experimental data with respect to prediction of the value of critical heat flux. The proposed empirical correlation is derived on the basis of Katto and Ohno model [16]. Additionally, the approach to prediction of dryout location in annular flow will be presented. It was possible thanks to the development of the three-equation model based on consideration of liquid mass balance in the film, a two-phase mixture in the core and the gas. The presented approach is more general, and its major advantage over a two-equation model due to Mikielewicz *et al.* [11] is that it does not require arbitral split of liquid into film and entrained droplets.

2 Experimental facility

Two working media SES36 and R123 were used in the experimental analysis. The experiment was carried out in the test section presented in Fig. 1. Analyzed tube was placed in the thermal insulation to limit heat losses to the environment. In this experiment a silver tube of 1.15 mm or 2.3 mm inner diameter, and the length of 38 cm was used. Current, voltage, inlet temperature, inlet pressure, outlet temperature and outlet pressure are measured at the test section to determine the corresponding heat flux, subcooled liquid temperature, saturation temperature of boiling liquid and pressure drop.

The infrared camera was used to find the position of liquid film dryout process. This camera allowed a non-invasive temperature measurement of the wall surface. The position of dryout was obtained in the post-processing analysis of the images.

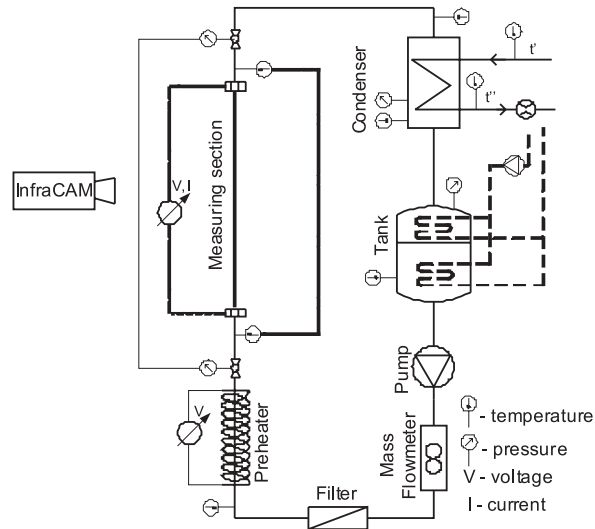

Figure 1. Scheme of experimental setup

The flow of working fluid is forced by a set of two electrically-powered pumps, composed in series, capable to deliver the mass flow rate up to 200 kg/h and overpressure up to 0.8 MPa. Gear pumps have been chosen to limit any arising flow pulsations. Adjustment of the mass flow is realized by changing voltage of the pump's power supply or using the by-pass. Working medium is pumped from the main tank through the Danfoss mass flow meter MASS D1 3 type working with MASS 6000 19" IP20 interface. Such system, gives about 0.3% measurement accuracy. In the present work the mass flow range from 1 to 4.5 kg/h has been considered. Then the working fluid goes to the pre-heater, where it attains required input parameters. Isobaric pre-heating is realized in the stainless steel tube powered by low voltage, high current DC power supply. Such arrangement gives up to 1.2 kW of heating power. In this way, the full range of quality x is possible to be achieved at the test section input. Current, voltage, inlet and outlet temperatures and pressure are measured on the pre-heater to determine a corresponding heat flux and quality x from the appropriate heat balance. From the pre-heater the medium goes directly to the test section.

In the experiment the infrared camera ThermoVision A325 (by FLIR-SystemsTM) was used together with the software ThermoCAMTM Researcher 2.9 Professional. The software can make recordings on high speed thermal events, show IR images, record them on disk and analyse them afterwards. It can also provide measurement result values directly from the live stream of images. The camera is working in the spectral band of 7.5–13.0 μm and is equipped with the FPA (Focal Plane Array) type detector. Detector resolution is 320×240 pixels (16-bit) and refreshing rate 60 Hz. Detector pitch is 25 μm and time constant 12 ms. Temperature measurement band ranges from 0 °C to 350 °C, the measurement accuracy is $\pm 2\%$. If the emissivity of the test article were known, the resolution of temperatures could be better than 70 mK at 30 °C. The camera has automatic atmospheric transmission correction (based on inputs for distance, atmospheric temperature and relative humidity), automatic optics transmission correction (based on signals from internal sensors), automatic reflected apparent temperature correction and external optics/windows correction. Emissivity is adjustable (0.01–1.00). It is set by calibration, executed individually for each section. Silver channel is covered with the passive layer with the use of chemical etching and annealing in temperature of 650 °C. Calibration is realized by measurement of the wall temperature using thermocouple (sensitivity of 0.1 °C and adjustment of emissivity in a way that reading from infrared camera and thermocouple are equivalent).

The experimental investigations were mainly concentrated on an influence of the flow velocity and supplied heat flux on the dryout in the flow, especially on the location of the liquid film dryout on the wall. Additionally, the comparison between the working media in respect of heat transfer from the unit area efficiency was provided. In Tab. 1 the range of conditions covered in the experiments is listed.

Table 1. Range of conditions covered in the study.

Fluid	D	G	q_{cr}	P_{mean}	Tsat	x_{cr}	L
	[mm]	[kg/m ² s]	[kW/m ²]	[MPa]	[°C]	[-]	[m]
SES 36	1.15	300, 500, 700, 900	20–100	0.1–0.20	33–70	0.86–1.00	0.380
	2.30	300, 500, 700	25–150	0.1–0.20	37–61	0.65–1.00	0.375
R123	1.15	300, 500, 700, 900	23–107	0.1–0.20	23–60	0.72–1.00	0.385
	2.30	300, 500, 700	65–150	0.1–0.24	27–67	0.75–1.00	0.385

3 Results

During experiments a constant value of mass velocity G for one cycle of measurements was kept. Using the infrared camera the boiling front-line was observed with increasing heat flux applied to the wall. It moved in the opposite direction in the comparison to the direction of test fluid flow in the channel. Figures 2 and 3 present the critical heat flux q_{cr} versus the critical length of the channel z_{cr} for chosen values of mass velocity G in the channel of 1.15 mm diameter for two considered fluids, namely SES36 and R123, respectively. It can be observed that with the increasing value of supplied heat flux the critical length z_{cr} decreases. It is related to the rate of liquid evaporation on the film interface. The greater the applied heat flux, the more intensive are the phenomena occurring in the annular flow and the faster is the complete evaporation of the fluid. During the liquid film dryout phenomena the additional disturbance is coming from the entrainment and deposition rates of droplets in the flow. Similar tendency can be found in the case of 2.3 mm diameter channel, however it should be emphasized that the higher the mass velocity of the test fluid, the larger is inclination of the lines.

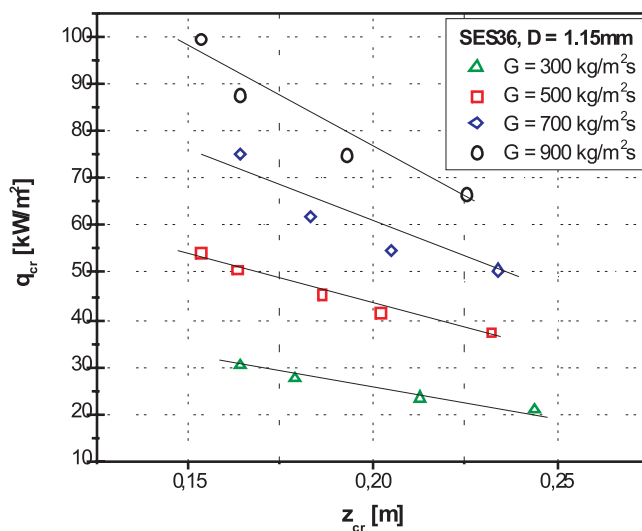

Figure 2. Critical heat flux versus critical length of liquid film dryout in the channel of $D = 1.15$ mm diameter for SES36.

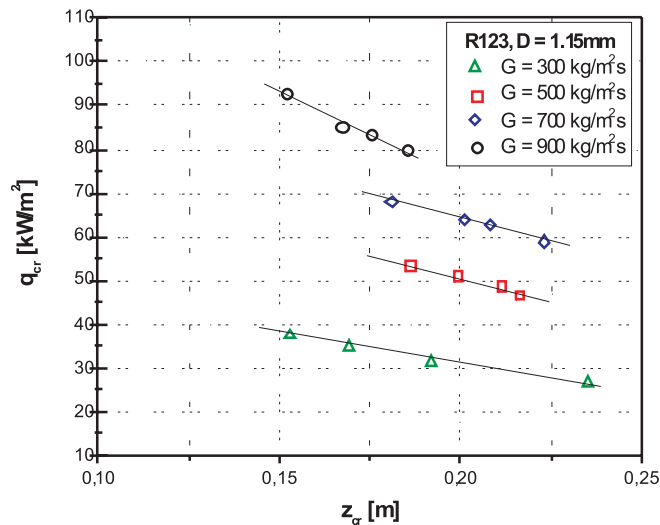

Figure 3. Critical heat flux versus critical length of liquid film dryout in the channel of $D = 1.15$ mm diameter for R123.

The influence of the channel length on the critical vapor quality was also analyzed. It was shown that the longer is the distance, on which the liquid evaporation in channel occurs, the higher is the vapor quality.

In Fig. 4 and 5 the dependence of critical vapor quality on the critical heat flux is presented for SES36 and R123, respectively. When the critical heat flux increases the critical vapor quality decreases with constant value of medium mass velocity.

The results for both media show that tendency and values of vapor quality are qualitatively similar, but they depend also on the mass velocity. The influence of mass velocity on the critical vapor quality was examined and the results are presented in Fig. 6 and 7. The distinct decrease of critical vapor quality with increase of mass velocity G is observed. When the influence of channel diameter is considered then the higher is the channel diameter the more intensive is the decrease of critical vapor quality. It can also find confirmation in the previous research done by Wojtan and Thome [18] and also Qi *et al.* [19].

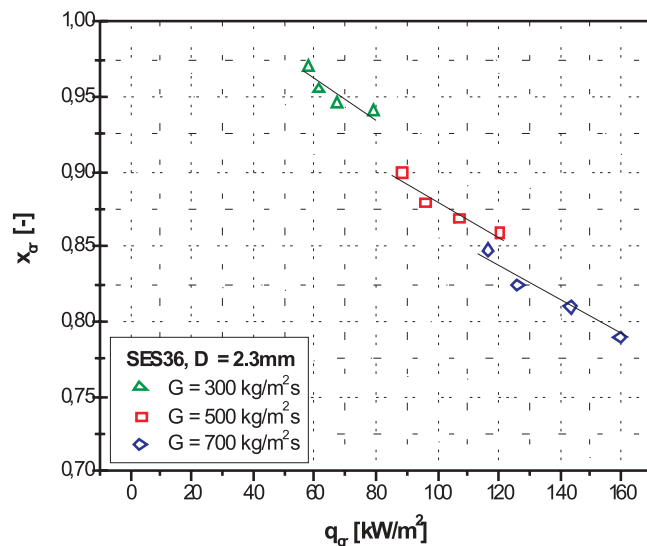

Figure 4. Critical vapor quality versus critical heat flux in the channel of $D = 2.3$ mm diameter for SES36.

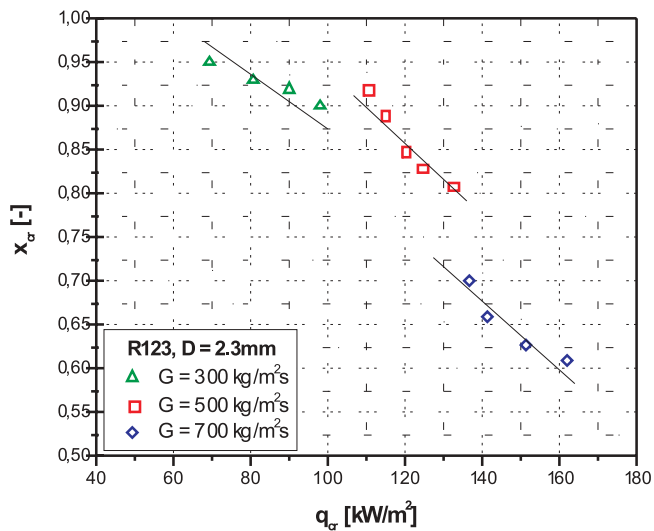

Figure 5. Critical vapor quality versus critical heat flux in the channel of $D = 2.3$ mm diameter for R123.

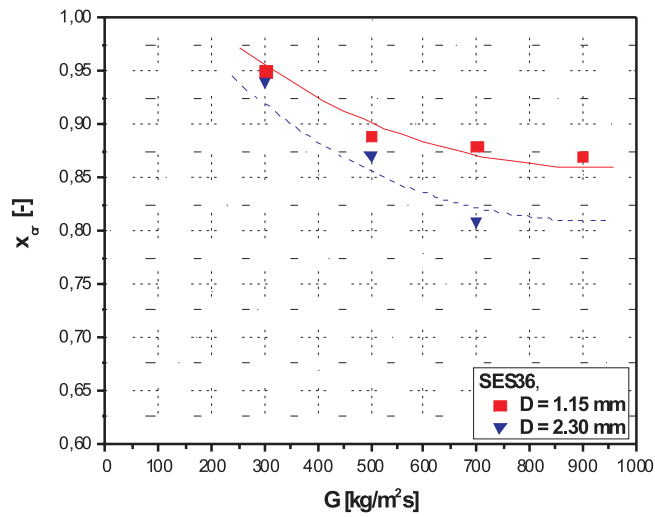

Figure 6. The critical vapor quality versus the velocity for SES36.

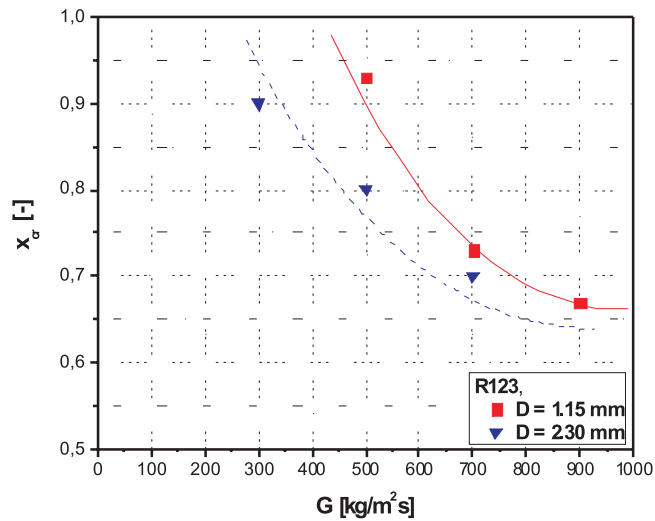

Figure 7. The critical vapor quality versus the mass velocity for R123.

On the basis of experimental results for two examined fluids the correlation describing the critical heat flux was proposed in the form:

$$\frac{q_{cr}}{h_{lv}G} = 0.62 \cdot \left(\frac{\rho_v}{\rho_l}\right)^{-0.02} \cdot (We_{(D)})^{-0.05} \cdot \left(\frac{L}{D}\right)^{-1.17} \quad (1)$$

Equation (1) is the function of mass velocity G , the length of tube L , the channel diameter D , the Weber number and the working medium properties. In the next step the correlation (Eq. (1)) was compared with the correlation proposed by Zhang *et al.* [20] and the mean square deviation (Fig. 8) was calculated. It can be seen that 100% of experimental results are in the error band of $\pm 30\%$ and 76% of results are in the range of $\pm 15\%$.

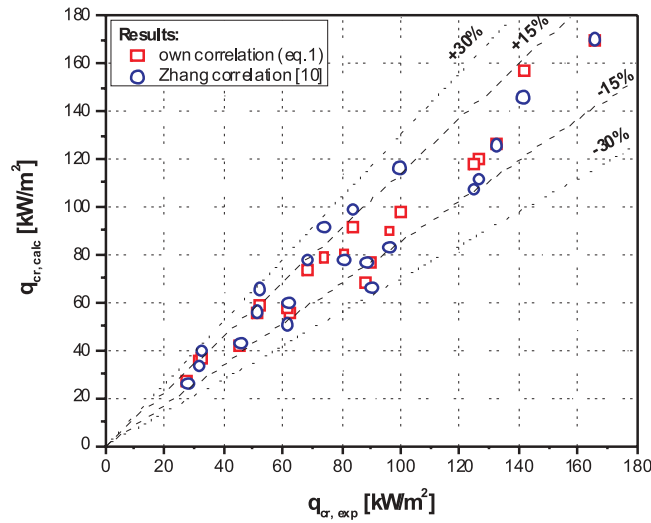

Figure 8. Comparison of g_{cr} predictions using correlation (1) and Zhang *et al.* [20] for SES36 and R123.

4 Theoretical model of dryout location

To simulate the boiling crisis of the second type the original three-equation (referred here later as 3R) model is formulated. It is based on the fluid balance in the film and in the core and also the vapor balance in the annular flow. This model is dedicated to the dryout location prediction in the conventional channels as well as and minichannels. It is more general

than the models proposed thus far, see for example Qu and Mudawar [1] and Revellin *et al.* [21]. In the case of the flow in small diameter channels (Fig. 9) it was assumed that:

- conditions of the onset of annular flow are known,
- total balance of mass velocity in the flow is equal to $G = G_f + G_c + G_v$,
- liquid film flow is laminar,
- liquid-vapor interface is stable, therefore the influence of surface tension is large,
- there is no entrainment of droplets G_E , what was also suggested by Qu and Mudawar [1].

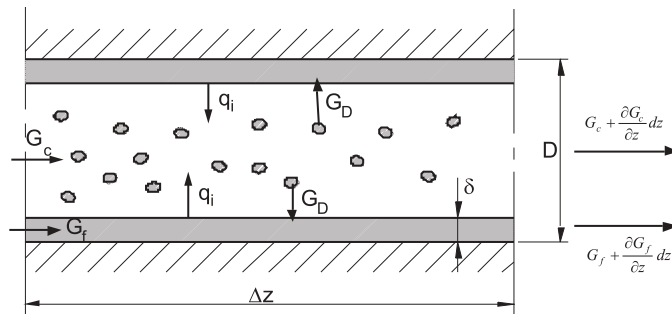

Figure 9. The model of annular flow in the small diameter channel.

Proposed model is essentially different from the one-equation model developed by Okawa *et al.* [12] and the two-equation model presented by Sedler and Mikielwicz [9]. It does not have the main disadvantage of “manual” splitting of the liquid flow into the liquid film flow and the droplets in the core. It is a meaningful progress in the modeling of these types of flows. In the 3R model it was assumed that the liquid film is flowing on the channel wall, while the core consists of a two-phase mixture (vapor-droplets).

Generally, the 3R model can be written in the form of three differential mass conservation equations for the liquid film, two-phase gas core and vapour phase itself, respectively:

$$\frac{dG_f}{dz} = \frac{4}{D} \left(G_D - \frac{q_i}{h_{lv}} \right), \quad (2)$$



$$\frac{dG_c}{dz} = \frac{4}{D} \left(\frac{q_i}{h_{lv}} - G_D \right), \quad (3)$$

$$\frac{dG_v}{dz} = \frac{4}{D} \frac{q_i}{h_{lv}}, \quad (4)$$

where $q_i = q_w \left(1 - \frac{2\delta}{D}\right)$.

The results of accomplished simulations show similar range of accuracy for both considered fluids, i.e. SES36 and R123 (respectively Fig. 10 and 11 and Fig. 12 and 13). Presented data are for two different channel diameters. For the channel of diameter $D = 1.15$ mm observed are larger discrepancies between the calculated and experimental data than in the case of $D = 2.3$ mm diameter. The one-equation (1R) model in the channel of 2.3 mm diameter and $G = 300$ kg/m²s gives better agreement with experimental data than the other considered models (Fig. 13). The influence of the mass velocity in the convergence of simulation and experimental data was similar (Fig. 14 and 15). The larger is mass velocity the better is agreement between the modeling and experimental results.

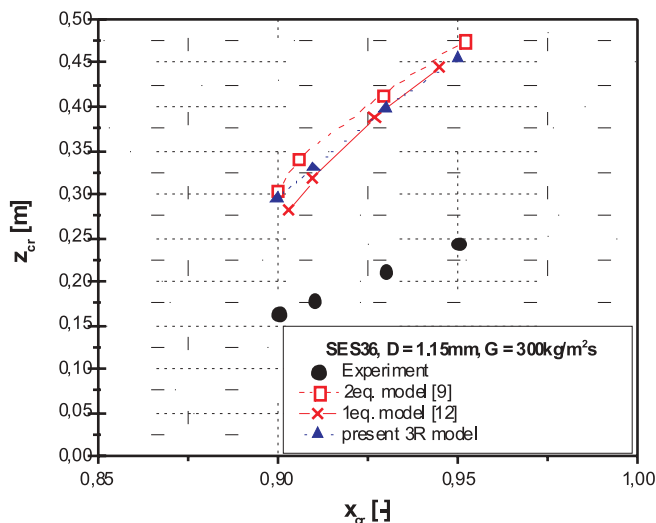

Figure 10. Comparison between the modeling and experimental data for SES 36 in the channel of $D = 1.15$ mm and $G = 300$ kg/m²s.



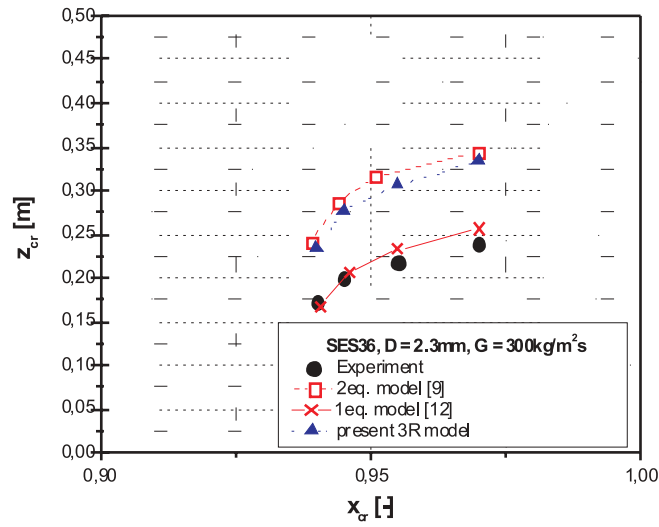

Figure 11. Comparison between the modeling and experimental data for SES 36 in the channel of $D = 2.3$ mm and $G = 300$ kg/m²s.

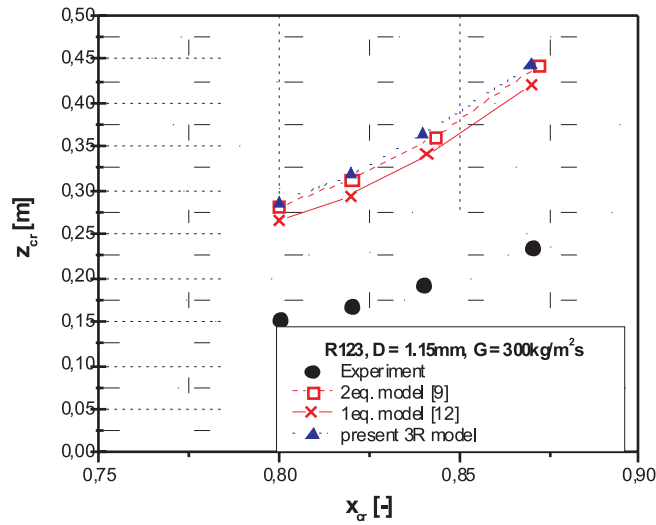

Figure 12. Comparison between the modeling and experimental data for R123 working medium in the channel with $D = 1.15$ mm and $G = 300$ kg/m²s.

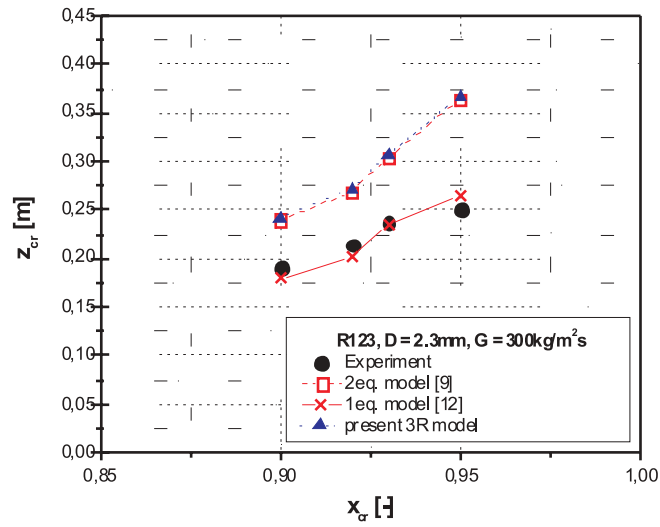

Figure 13. Comparison between the modeling and experimental data for R123 working medium in the channel with $D = 2.3$ mm and $G = 300$ kg/m²s.

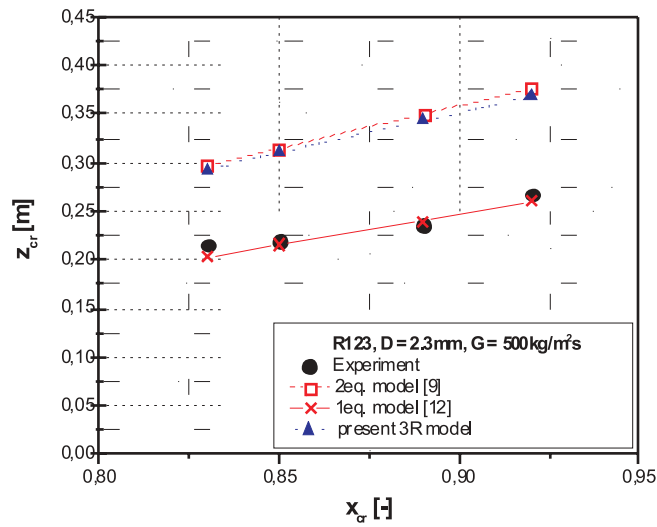

Figure 14. Influence of the R123 mass flux density on the simulation results accuracy for $D = 2.3$ mm.

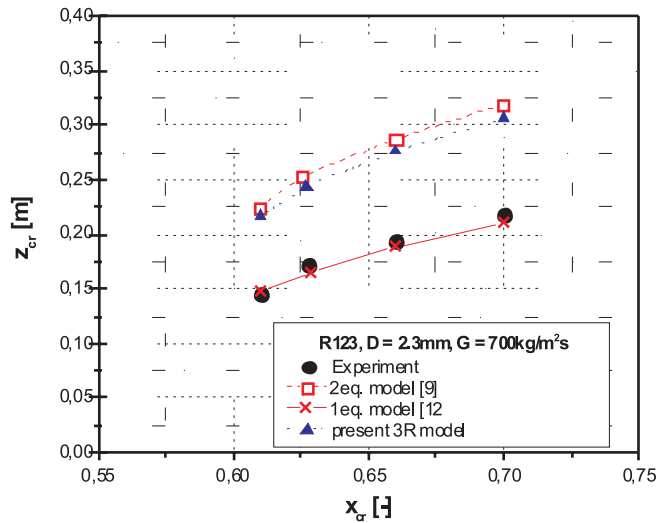

Figure 15. Influence of the R123 mass flux density on the simulation results accuracy for $D = 2.3$ mm.

5 Conclusions

In the paper the experimental results of liquid film dryout on the channel wall were presented in channels with two diameters, namely $D = 1.15$ mm and $D = 2.3$ mm for two low-boiling point fluids namely SES36 and R123. The infrared camera was used in the experimental studies for precise determination of the boiling crisis location. The influence of applied heat flux on the critical length and critical vapor quality was demonstrated. It was observed that with increase of applied heat flux to the wall the critical length z_{cr} decreases and that with increase of heat flux the critical vapor quality also decreases at constant value of mass velocity. The influence of mass velocity on the values of critical vapor quality was also estimated and it was found that the critical vapor quality distinctly decreases with increase in the mass velocity G .

The influence of the channel diameter was also taken into account. The results show that the bigger is the channel diameter the more intensive is decrease in the critical vapor quality. It is in line with experimental results obtained by Wojtan *et al.* [18] and by Qi *et al.* [19]. On the basis of experimental data base the empirical correlation describing the critical

heat flux value (Eq. (1)) was proposed. It shows a good consistency with acquired data base as all experiments fall into the error band of $\pm 30\%$. The predictions by that correlation were also compared with another empirical correlation due to Zhang *et al.* [20]. Also in that case a good consistency of predictions between the two correlations was obtained.

Additionally, to model the conditions of boiling crisis of the second type the three-equation (3R) model was proposed. The model considers three equations of mass balance, namely for liquid film, two-phase core and vapour phase. It gives the results, which are comparable with the one-equation model due to Okawa *et al.* [12] and the two-equations model due to Sedler and Mikielwicz [9] for investigated range of experimental data. The supremacy of the proposed 3R over other considered models lies in the fact that the 3R model does not require the user to interfere with the split of liquid between the liquid film and the two-phase core, which makes it superior to other models. In the future activities it would be possible to improve the accuracy of three-equation model, when the specially developed correlations describing the deposition and entrainment terms in particular phases appearing in the 3R model will be introduced, which will be specially developed for minichannels. A major improvement would be to include momentum equations for liquid film and vapour core.

Acknowledgement Second and third authors kindly acknowledge the funding in the frame of the research projects of Ministry of Science and Higher Education No. 3T10B 003 30 and No. N513 3855 33.

Received 18 March 2011

References

- [1] QU W., MUDAWAR I.: *Flow boiling heat transfer in two-phase micro channel heat sinks – II. Annular two-phase flow model*. Int. J. Heat and Mass Transfer **46**(2003), 2772–2784.
- [2] KANDLIKAR S.: *Critical heat flux in subcooled flow boiling – an assessment of current understanding and future directions for research*. Multiphase Science and Technology **13**(2001) 3, 207–232.
- [3] BERGLES A., KANDLIKAR S.G.: *Critical heat flux in microchannels: Experimental issues and guidelines for measurement*. First Int. Conf. on Microchannels and Minichannels, 24–25 April 2003, New York, ICMM2003-1016, 2003, 177–206.
- [4] CELATA G.P., MISHIMA K., ZUMMO G.: *Critical heat flux for saturated flow boiling of water in vertical tubes*. Int. J. Heat Mass Transfer **44**(2001), 4323–4331.



- [5] WHALLEY P.B., HUTCHINSON P., HEWITT G.F.: *The calculation of critical heat flux in forced convection boiling*. In: 5th Int. Heat Transfer Conference, Japan, 1974, B6.11, 290–294.
- [6] KATAOKA I., ISHII M.: *Mechanism and correlation of droplet entrainment and deposition in annular two-phase flow*. Nuclear Regulatory Commission NUREG/CR – 2885, ANL – 82-44, 1982.
- [7] UEDA T., INOUE M., NAGATOME S.: *Critical heat flux and droplet entrainment rate in boiling of falling liquid films*. Int. J. Heat Mass Transfer **24**(1981) 7, 1257–1266.
- [8] MISHIMA K., ISHII M.: *Flow regime transition criteria for upward two-phase flow in vertical tubes*. Int. J. Heat Mass Transfer **5**(1984), 723–737.
- [9] SEDLER B., MIKIELEWICZ J.: *A simplified model of the boiling crisis*, Int. J. Heat Mass Transfer **24**(1981), 431–438.
- [10] CUMO M, MACIUCA C., MORONESI M., PALAZI G.: *A burnout correlation to scale water with freon*. European Two_Phase Flow Group Meeting, Harwell, 1974.
- [11] MIKIELEWICZ D., MIKIELEWICZ J., WAJS J., GLIŃSKI M.: *A model of dryout in annular flow*. 6th International Conference on Multiphase Flow, ICMF 2007, Leipzig, 9–13 July 2007.
- [12] OKAWA T., KOTANI A., KATAOKA I., NAITO M.: *Prediction of the critical heat flux in annular regime in various vertical channels*. Nucl. Engng and Design **229**(2004), 223–236.
- [13] KLUGMANN M.: *Enhancement of heat Exchange in flow boiling in minichannels*. PhD thesis, Gdańsk University of Technology, Faculty of Mechanical Engineering, Gdańsk 2009 (in Polish).
- [14] TESMAR J.: *General semi-empirical flow boiling model for conventional and small diameter channels*. PhD thesis, Gdańsk University of Technology, Faculty of Mechanical Engineering, Gdańsk 2008 (in Polish).
- [15] GLIŃSKI M.: *Experimental and theoretical investigation of dryout in minichannels*. PhD thesis, Gdańsk University of Technology, Faculty of Mechanical Engineering, Gdańsk 2010 (in Polish).
- [16] KATTO Y., OHNO H.: *An improved version of the generalized correlation of critical heat flux for the forced convection boiling in uniformly heated vertical tubes*. Int. J. Heat Mass Transfer **27**(1984), 1641–1648.
- [17] Refprop 8.0, NIST, 2007.
- [18] WOJTAN L., REVELLIN R., THOME J.R.: *Investigation of critical heat flux in single, uniformly heated microchannels*. Experimental Thermal and Fluid Science **30**(2006), 765–774.
- [19] QI S.L., ZHANG P., WANG R.Z., XU L.X.: *Flow boiling of liquid nitrogen in micro-tubes: Part II – Heat transfer characteristics and critical heat flux*. Int. J. Heat Mass Transfer **50**(2007), 5017–5030.
- [20] ZHANG W., HIBIKI T., MISHIMA K., MI Y.: *Correlation for critical heat flux for flow boiling of water in mini-channels*. Int. J. Heat Mass Transfer **49**(2006), 1058–1072.



- [21] REVELLIN R., HABERSCHILL P., BONJOUR J., THOME J.R.: *Conditions of liquid film dryout during saturated flow boiling in microchannels*. Chemical Engineering Science 63(2008), 5795–5801.