

## Impact of dielectric deterioration on the conducted EMI emissions in the DC-DC boost converter

**Streszczenie.** W artykule przedstawiono wpływ starzenia kondensatorów elektrolitycznych na poziom zaburzeń elektromagnetycznych generowanych przez układ podwyższający napięcie w oparciu o metody symulacyjne oraz cyfrowe przetwarzanie sygnału (filtracje Wienera). Wyniki przedstawiono w formie widm zaburzeń generowanych przez układ oraz transmitancji pomiędzy źródłem zaburzeń a zaburzeniami. (Wpływ starzenia się dielektryków na poziom zaburzeń generowanych w impulsowym układzie podwyższającym napięcie)

**Abstract.** The magnitude of emitted noise generated by DC-DC converters depends of their electrical behavior and parameters. Some of these can change during the converter life time, especially due to some deterioration process. In this paper the impact of the dielectric materials aging is presented using both circuit simulation and a digital signal processing method based on Wiener filtering. The change of the total EMI spectrum as a function of the dielectric property has been investigated. Application can be either aging diagnostig, or a forecast of the EMI spectrum evolution with the time.

**Słowa kluczowe:** kompatybilność elektromagnetyczna, procesy starzeniowe, symulacje komputerowa, filtracje Wienera.  
**Keywords:** EMC, aging process, computer simulation, Wiener filtering.

### Introduction

Increasing switching frequencies of switch-mode power supplies is strongly connected with increasing of electromagnetic interference (EMI) emissions. Many EMC standards and regulations such as the Federal Communications Commission (FCC), the International Electrotechnical Commission (IEC) and the International Special Committee on Radio Interference (CISPR) standards have been established for controlling EMI emission. EMI generated by electronic equipment should be lower than limits defined in standards. The level of emitted noise is determined by the electrical behavior which depends on geometrical structures of the system, devices packaging, layout of the circuit, parasitic components, current and voltage slew rates [1]. Unfortunately, this parameters change during the converter life time, because of aging and deterioration processes [2] [3], especially for harsh environment (high temperature). In this paper, the

influence of deterioration of input capacitors and isolation layer on level and propagation path in DC/DC boost converter is analyzed using simulation [4] and digital signal processing method - Wiener filtering (WF) [5]. The first method requires precise wide-band modeling of all components of converter [6], including electrical interconnections (parasitic capacitances and inductances) of all passive components and semiconductor devices [7]. The second method is based on WF, which determines contributions to perturbations level, due to every power semiconductor turn on and turn off transients. In this approach, a transfer function links the level of noise measured on a line impedance stabilization network (LISN) to the source of disturbances (e.g. semiconductor voltage). The great advantage of this method is that it does not require any knowledge on the converter structure or parameters; it's a kind of "black box" approach [8].

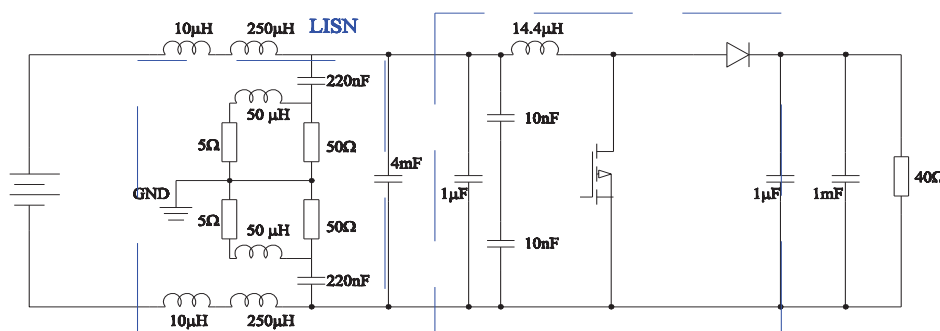

Fig. 1. Automotive DC-DC boost converter fed through the LISN: schematic diagram and experimental prototype view

In order to evaluate the impact of parasitic on the conducted EMI emissions, a temporal simulation and the use of transfer functions, identified using the Wiener Filtering approach, will be compared in the example of a DC-DC boost converter. In Figure 1 it is shown the developed converter supplied from the DC voltage source through the LISN circuit. It has been designed for typical automotive applications where two levels of voltages 14/42 V, power 100 W were required. In the evaluated converter, the switching frequency of the MOSFET transistor, operating with the duty cycle  $D=0.75$ , was set to 100 kHz. To enhance cooling, instead of conventional

printed circuit board (PCB), compliant with automotive constraints the Insulated Metal Substrate (IMS) was used [9]. The input filter contains one electrolytic capacitors 4mF and three ceramic capacitors. This classical power electronics application has been chosen because of its relatively simple topology [10], that allows a simple development and explanation of the proposed methodology.

The paper is organized as follows. In the first section, time domain simulations using precise models for each circuit component, are studied including parasitic paths of capacitive and inductive interconnections. This research is completed by the Wiener filters derived from the simulation

EMI models in the second section. A generation of numerous transfer functions between semiconductor devices and EMI emission allows finding the role of the input capacitor and isolation layer on the resulting on EMI emissions. This is systematically described in the section third in the form of a sensitivity case study.

### Accurate modeling - simulations

Simulations, using the complex model of the evaluated converter, has been carried out by the SABER circuit simulator. To obtain accurate EMC behavior of a power converter necessitates precise simulation. Semiconductor devices, such as diode and MOSFET, are identified as disturbance sources and must be modeled with high precision. However, even if a model can be found in Saber library, it is necessary to provide it with parameters. A generic parameter extraction method from [11] has been used for this purpose. For passive components (inductor and capacitors), measurement bridge HP4194A has been used to built in electrical equivalent circuit [12]. All interconnection parasitics (inductance, capacitance) cannot be easily measured, therefore corresponding model parameters have been calculated based on the Partial Element Equivalent Circuit (PEEC) modeling method [13]. The parasitic capacitances between tracks and ground have been calculated using the following Wheeler/Schneider formula [11], where the results are given in pF/m.

$$(1) \quad C = \frac{1.122\epsilon_{eff}}{\ln \left[ 1 + \frac{1}{2} \left( \frac{8h}{w_{eff}} \right) \left( \frac{8h}{w_{eff}} + \sqrt{\left( \frac{8h}{w_{eff}} \right)^2 + \pi^2} \right) \right]}$$

where  $\epsilon_r$  - the dielectric constants,  $w$  and  $t$  - width and thickness of the track,  $h$  - the distance between the track and ground and additional coefficients have been defined as follow:

$$(2) \quad \epsilon_{eff} = \frac{\epsilon_r + 1}{2} + \frac{\epsilon_r - 1}{2} \left( 1 + \frac{10h}{w} \right)^{-1/2}$$

$$(3) \quad w_{eff} = w + \frac{t}{\pi} \ln \left[ \frac{4e}{\sqrt{\left( \frac{t}{h} \right)^2 + \frac{1}{\pi \left( \frac{w}{t} + 1.1 \right)^2}}} \right]$$

where  $e$  - basis of the neperian logarithm.

According to the PEEC method, a capacitive meshing can also be used. Parasitic capacitance to the ground can be represented by capacitors mesh. Capacitance of each track is calculated from the capacitors mesh as described in [4].

Complete electrical equivalent circuit can thus be obtained, including the converter itself with all complex models of components and parasitics, including the measurement equipment, LISN and the cabling impedance between LISN and converter. Powerful simulator is needed, which allows to perform simulations with a sufficient small time step, according to the required conducted EMI frequency range (30MHz). Because of very large time constants of basic boost converter and of the LISN, long time-consuming simulations have been carried using SABER to obtain steady state operation. In Figure 2.

equivalent scheme of boost converter, the LISN and load build in Saber@Sketch is presented. All interconnections of converter (IMS, screws and bonding) are summarized into a single macro components. Using strictly results from PEEC method in the circuit simulator is an undue burden on computer simulation. Therefore, a model reduction for inductive aspects has been proposed [15]. The points of connections between components and copper tracks have been apportioned - the idea is similar to scattering matrix from the microwave theory [16]: the complete geometry is seen from input-output only.

In order to validate a wide band modeling accuracy, an experimental measurement of conducted EMI of the DC/DC boost converter has been carried out. The converter has been connected to power supply through the LISN. The experimental power MOSFET voltage transients - the main source of perturbation - follow nearly perfectly the simulation waveforms (Fig 3). Obtained correlation is quite good, taking into account all measurement inaccuracies as voltage cannot be precisely measured directly across the transistor.

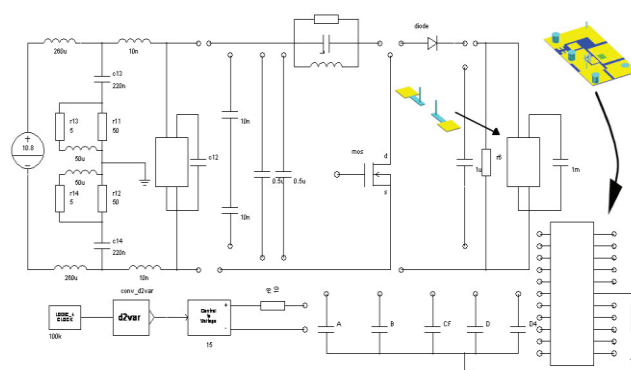

Fig.2. Saber simulation model of the DC-DC boost converter, LISN and macro components

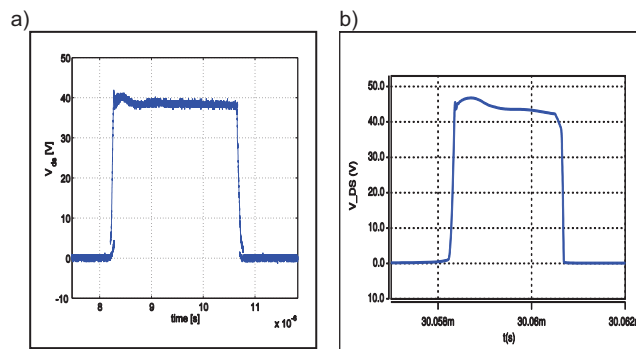

Fig.3. MOSFET voltage waveforms; a) measured b) simulated

### Wiener filtering

The Wiener filtering minimizes the average squared error between the filter output and a real signal. Theory assumes that the signals are stationary. Theory of optimum linear filters for the general case of minimum mean square error criterion was developed by Wiener for continuous time and independently by Kolmogorov for discrete time systems [17], [18]. In this approach, Wiener filters used for the EMI estimation are fed by power switch voltage or current transients, as represented by the source of disturbances in Fig. 4.

The frequency response of the optimal Wiener filter.

$$(4) \quad H(j\omega) = \frac{S_{vp}(j\omega)}{S_{vv}(j\omega)}$$

where:  $S_{vv}(j\omega) = \hat{E}\{[V(j\omega)]^2\}$  is the power spectrum of  $v$ ,  $S_{vp}(j\omega) = \hat{E}\{[P(j\omega)]^* V(j\omega)\}$  is the cross power spectrum between  $v$  and  $p$ . In order to estimate  $H(j\omega)$ , one must first measure data of input  $v$  and output  $p$  signals. Then, these data can be used to estimate power and cross-power spectra of Eq. (4), and finally the frequency response of the optimal Wiener filter. Once this filter has been estimated, it can be applied to any form of disturbance source  $v$  in order to predict corresponding disturbances  $p_v$ .

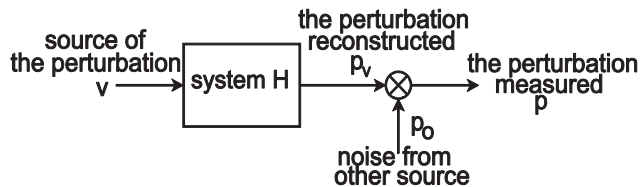

Rys.4. Wiener filtering in estimation of EMI

It can be used to investigate phenomena related with EMI noise generation, where the EMI behavior of power electronic converter and LISN are represented by the system which contains transfer function between source of disturbances and noise measured on LISN. The time and frequency domain methods can be used with either measurement or simulation signals. In order to analyze the boost converter behavior (in the frequency range of the conducted EMI), transfer function between a source of disturbances ( $V_{ds}$ ) and disturbances ( $V_{LISN}$ ) has been

identified. It is a numerical representation of all components and layout parasitics which take a part in perturbation propagation. The calculation was obtained using Matlab.

The values of WF amplitude has been normalized with normalization coefficients for Matlab functions as: discrete Fourier transform or complex conjugation. The great advantage of using this method in EMC analyzes is that WF transfer function is independent of measured signals and gives numerical information about converter layout.

### Sensitivity study

The global EMC simulation is not sufficient to understand all phenomena which originate EMI. Therefore, it is not straightforward to modify the real converter if the EMC behavior is not unacceptable. Hence, a sensitivity study is carried out, in order to determine the influence of deterioration input capacitor and isolation layer on the EMI spectrum. Using data from simulation the common (CM) and differential (DM) mode perturbation have been calculated.

In Figure 5 the generated perturbation and transfer function are presented for real application. The EMI are mainly of the CM character, the DM interference are strongly attenuated, what is attributed to input capacitor filtering capability. The CM transfer function is rising for higher frequencies because the parasitic capacitances to the ground play the main role in EMI propagation.

a)

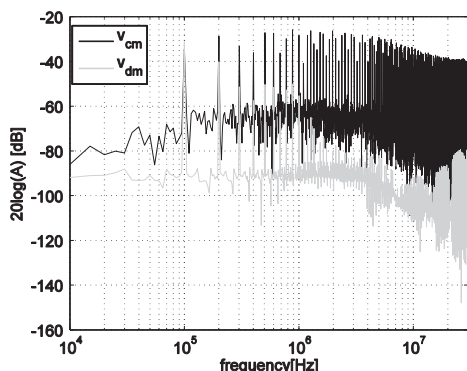

b)

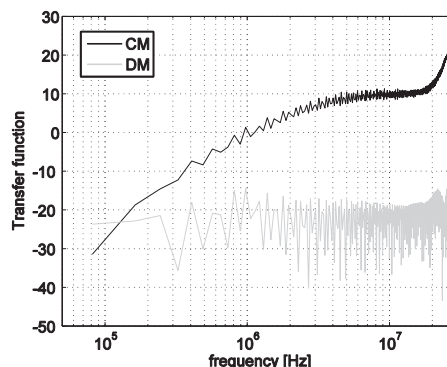
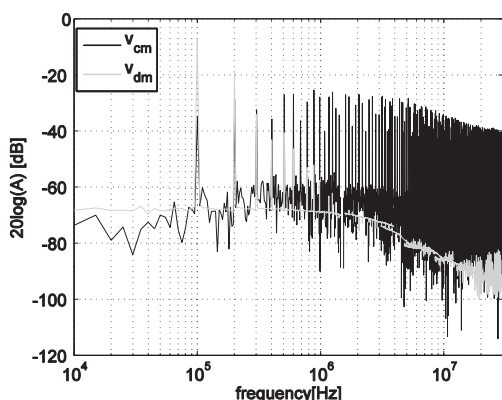

Fig.5. DC-DC boost converter a) generated perturbation spectra b) transfer function (WF approach).

a)



b)

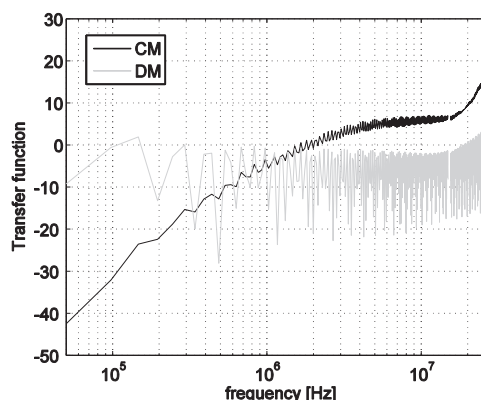

Fig.6. Impact of the input capacitor aging on DC-DC boost converter after 6k operation hours a) generated perturbation spectra b) transfer function

### Input capacitor

In order to predict the impact of the aging of the electrolytic capacitor, the value of the capacitance and

ESR (equivalent series resistance) have been changed similarly as described in [18]. After 6000 working hours, the value of capacitance can decrease about 10% but the ESR

increase even 5 times, because of temperature condition and current ripples lead to acceleration of the electrolyte evaporation of the electrolyte [3]. The filtering ability of input capacitor decreased. The CM perturbations remain on the same level, but the DM slightly increase 20dB, especially in the frequency range below 10MHz (Fig. 6a). The amplitude of transfer function also increased but in the whole considered frequency range (Fig. 6b).

After 9000 hours the value of capacitance decreases 30%, while ESR can increase even 30 times. In this case, DM are almost no more filtered by the input capacitor. The perturbation for 100kHz DC-DC converter operation frequency and over-harmonics strongly increased. In the range from 10kHz to 10MHz, the level of DM is almost the same as CM (Fig. 7a). The transfer function amplitude is still increasing (Fig 7b). It can be

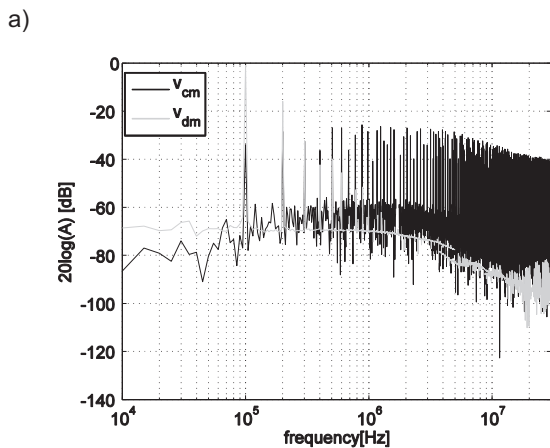

said that this capacitor is useless, because its impedance for considered frequency range is too large (fig 8).

### Dielectric insulation

Deterioration of the IMS dielectrics leads not only to alteration of capacitors parameters, but also has an impact on insulation properties. The parasitic capacitances, especially to the ground, are the part of EMI propagation path and have an influence on the level of perturbation. The value of the parasitic capacitance depends *inter alia* on the dielectric constants (Eq. 1), which is changing because of the aging process [19]. After 1000 working hours values of capacitance between conducted track and the ground can decies even 10 times. In figure 9 it is presented that due to decreasing of the parasitic capacitance, the CM perturbations also reduced, but the DM strongly increase, especially for frequencies close to 10 MHz.

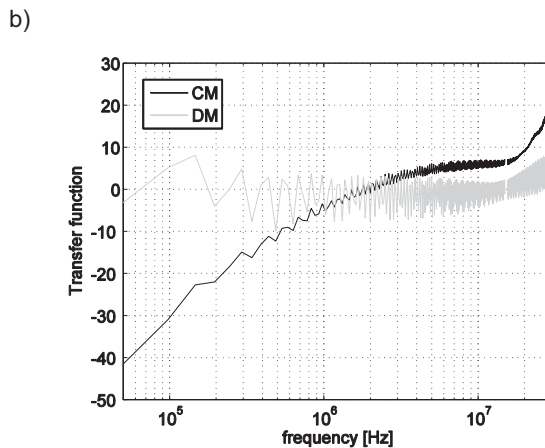

Fig.7. Impact of the input capacitor aging on DC-DC boost converter after 9k operation hours a) generated perturbation spectra b) transfer function

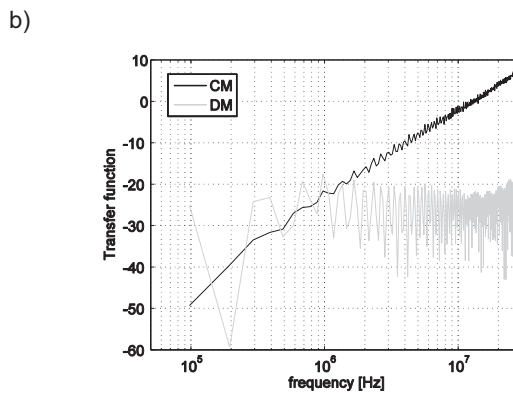
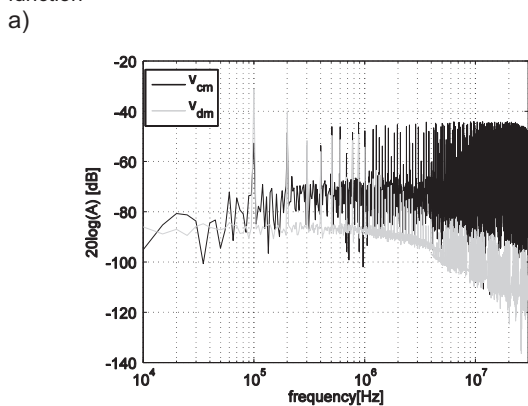

Fig.9. Impact of the isolation aging on DC-DC boost converter after 1k and more operation hours a) generated perturbation spectra b) transfer function

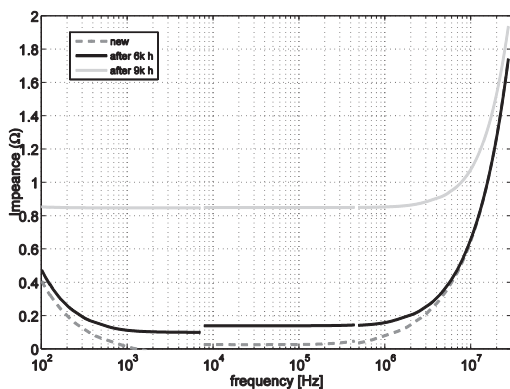

Fig.8. Impedance of electrolytic input capacitor : new, after 6k working hours, after 9k working hours

Influence of both input capacitor and insulation aging are presented in figure 10. In this particular case, it has positive impact on the CM perturbation which level has decreased in the whole frequency range, what is also visible in WF transfer function. Unfortunately the DM level has increased, because filtering conditions deteriorate as is presented in WF transfer function (fig. 10.b).

### Conclusion

A generic method for account the stray elements of power circuit layout (inductive and capacitive) in the SABER@ temporal simulation is applied to forecast the EMI spectrum. Simulation study allows to investigate the influence of individual components or its parameters on the EMI level. The Wiener filtering method is used in order to identify the transfer functions, which describes EMI emissions and propagations paths. Moreover, the envelope of the transfer function

depends on physical properties of the circuit and doesn't depend on operation conditions, like  $dv/dt$  or  $di/dt$ . After validation with experimental results, a sensibility study allows a better understanding of the contribution of each stray element on the global EMC spectrum. The parasitic components like capacitance to the ground have a significant impact on the EMI emission and can not to be neglected, what has been proved and depicted in the  $V_{LISN}$  spectra. The small changes are not visible in a)

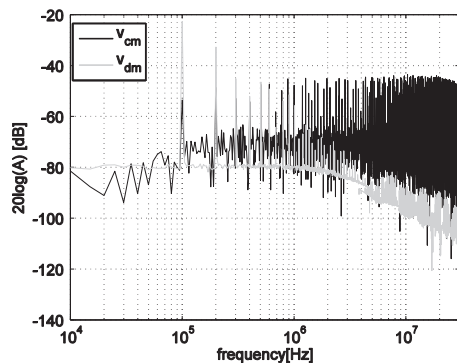

$V_{LISN}$  spectra for considered operation condition, but it is shown in WF transfer function. The parameters of passive components and isolation layer change during working time of converter. They have direct impact on interference generation and propagation paths. It can be noticed that EMI generated in Power Electronics converters change during working time, in extreme cases overriding acceptable limits. The solution of this problem is to use two or more type of capacitors parallel e.g. electrolytic and ceramic capacitors. b)

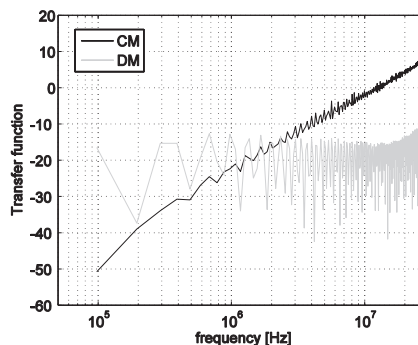

Fig.10. Impact of the dielectric material aging on DC-DC boost converter after 9k hours a) generated perturbation spectra b) transfer function

#### REFERENCES

- [1] A. Lahyani, P. Venet, G. Grellet, and P. J. Viverge. Failure prediction of electrolytic capacitors during operation of a switchmode power supply. *IEEE Transactions on Power Electronics*, 13(6):1199--1207, 1998.
- [2] T.J. Kim, J.-W. Baek, J.-H. Jeon, G.-H. Rim, and C.-U. Kim. A diagnosis method of DC/DC converter aging based on the variation of parasitic. In *Proc. 30th Annual Conference of IEEE Industrial Electronics Society IECON 2004*, volume 3, pages 3037--3041 Vol. 3, 2004.
- [3] T. Yorozyua, N. Takasu, K. Suganuma, K. Takahashi, K. Kamba, and T. Ichiwara. Study on diagnostic method of deterioration for power capacitors. In *Proc. 3rd International Conference on Properties and Applications of Dielectric Materials*, pages 745--748 vol.2, 1991.
- [4] P. Musznicki, J.L. Schanen, B. Allard, and P. J. Chrzan. Accurate modeling of layout parasitic to forecast EMI emitted from a DC-DC converter. In *Proc. IEEE 35th Annual Power Electronics Specialists Conf. PESC 04*, vol. 1, 278--283 2004.
- [5] P. Musznicki, J.L. Schanen, P. Granjon, and P. J. Chrzan. The Wiener filter applied to EMI decomposition. *IEEE Transactions on Power Electronics*, 23(6):3088--3093, 2008.
- [6] J.-S. Lai, H. Xudong, E. Pepa, C. Shaotang, and T. Nehl. Inverter EMI modeling and simulation methodologies. *IEEE Transactions on Industrial Electronics*, 53(3):736--744, 2006.
- [7] L. Yang, B. Lu, W. Dong, Z. Lu, M. Xu, F. Lee, and W. Odendaal. Modeling and characterization of a 1 kw ccm pfc converter for conducted EMI prediction. In *Proc. Nineteenth Annual IEEE Applied Power Electronics Conference and Exposition APEC '04*, volume 2, pages 763--769, 2004.
- [8] P. Musznicki. *Conducted EMI identification in Power Electronic converters*. VDM Verlag, 2009.
- [9] M. Sayani. DC-DC converter using all surface-mount components and insulated-metal substrate. In *Applied Power Electronics Conference and Exposition, 1992. APEC '92. Conference Proceedings 1992.*, Seventh Ann., 639--646, 1992.
- [10] M. Gitau. Modeling conducted EMI noise generation and propagation in boost converters. In *Industrial Electronics, 2000. ISIE 2000. Proceedings of the 2000 IEEE International Symposium on*, volume 2, pages 353--358, 2000.
- [11] B. Allard, H. Garrab, W. Mi, K. Ammous, and H. Morel. Switching parameter maps-a new approach to the validity domain of power device models. In *Proc. IEEE 34th Annual Power Electronics Specialist Conference PESC '03*, volume 3, pages 1220--1225, 15--19 June 2003.
- [12] E. Bogatin. A closed form analytical model for the electrical properties of microstrip interconnects. *Components, Hybrids, and Manufacturing Technology*, *IEEE Transactions on*, 13(2):258--266, 1990.
- [13] A. E. Ruehli. Inductance calculations in a complex integrated circuit environment. *IBM Journal of Research and Development*, 16(5):470--481, Sept. 1972.
- [14] C. Martin, J.L. Schanen, and R. Pasterczyk. Power integration: electrical analysis of new emerging package. *10th European Conference on Power Electronics and Applications EPE'03*, June 2002.
- [15] K. Kurokawa. Power waves and the scattering matrix. *IEEE Transactions on Microwave Theory and Techniques*, 13(2):194--202, Mar 1965.
- [16] D. G. Manolakis, V. K. Ingle, and S. M. Kogan. *Statistical and adaptive signal processing: spectral estimation, signal modeling, adaptive filtering, and array processing*. Artech House, Inc, 2005.
- [17] S.-V. Vaseghi. *Advance digital signal processing and noise reduction*. John Wiley and Sons Ltd, 2000.
- [18] K. Harada, A. Katsuki, and M. Fujiwara. Use of esr for deterioration diagnosis of electrolytic capacitor. *IEEE Transactions on Power Electronics*, 8(4):355--361, 1993.
- [19] M. C. Lanca, C. J. Dias, D. K. Das Gupta, and J. Marat-Mendes. Comparative study of dielectric relaxation spectra of electrically and thermally aged low density polyethylene. In *Proc. Annual Report Electrical Insulation and Dielectric Phenomena Conference on*, pages 161--164, 2003.

**Autorzy:** dr inż. Piotr Musznicki, dr inż. Jarosław Łuszcz Politechnika Gdańska, Wydział Elektrotechniki i Automatyki Instytut Elektroenergetyki, ul Sobieskiego 7, 80-216 Gdańsk [p.musznicki@ely.pg.gda.pl](mailto:p.musznicki@ely.pg.gda.pl), [juszcz@ely.pg.gda.pl](mailto:juszcz@ely.pg.gda.pl), prof. Jean-Luc Schanen INP Grenoble Electrical Engineering Laboratory [jean-luc.schanen@g2elab.grenoble-inp.fr](mailto:jean-luc.schanen@g2elab.grenoble-inp.fr), dr Pierre Granjon, INP Image Speech Signal Automatics Laboratory [pierre.granjon@gipsa-lab.inpg.fr](mailto:pierre.granjon@gipsa-lab.inpg.fr) ENSE3 bat D;961, rue Houille Blanche;BP 46;38402 St Martin d'Hères Cedex