

## **HEAT TRANSFER CHARACTERISTICS OF A TWO-PHASE THERMOSYPHON HEAT EXCHANGER**

**Janusz T. Cieśliński<sup>1</sup>, Artur Fiuk<sup>2</sup>**

<sup>1</sup>Gdansk University of Technology, Gdańsk, Poland, [jcieslin@pg.gda.pl](mailto:jcieslin@pg.gda.pl)

<sup>2</sup>SECESPOL Ltd., Gdańsk, Poland, [afiuk@secespol.pl](mailto:afiuk@secespol.pl)

Corresponding author: Prof. Janusz T. Cieśliński, Gdańsk University of Technology,  
Narutowicza 11/12, 80233 Gdańsk, Poland, [jcieslin@pg.gda.pl](mailto:jcieslin@pg.gda.pl)

### **Abstract**

In this paper, a special design for a two-phase thermosyphon heat exchanger is proposed. This design features an evaporator tube bundle consisting of smooth, corrugated or porous coated tubes. The prototype heat exchanger consists of two horizontal cylindrical vessels connected by two risers and a downcomer. Tube bundles placed in the lower and upper cylinder function as an evaporator and a condenser. The operation of a two-phase thermosyphon is determined primarily by the evaporator's performance. Therefore, an experimental investigation was conducted to determine the effects of the evaporator tube pitch (1.7d and 2.0d), the liquid head and fluid type on heat transfer in this two-phase thermosyphon heat exchanger. The investigation concerned six prototype heat exchangers operating in a heat flux range of 5–70 kW/m<sup>2</sup>. As working fluids, distilled water, methanol and refrigerant R-141b were utilised. The tested two-phase thermosyphon heat exchanger operates in a vacuum, and therefore the working liquids boiled in temperatures ranging from 24°C to 62°C. The obtained results indicate that the two-phase thermosyphon heat exchanger performs more effectively with an evaporator bundle comprising of porous coated tubes than with corrugated or smooth tubes. The evaporation heat transfer coefficient is strongly dependent on the liquid level above the top tube row (5 mm, 15 mm and 20 mm).

**Keywords:** Thermosyphon; Enhanced boiling; Tube bundle; Heat exchanger

## 1. Introduction

Two-phase thermosyphon heat exchangers (TPTHEx) are recuperators with an intermediate working fluid. This type of heat exchanger is used in a variety of heat transfer applications, but the heat transfer process mechanism in shell-side boiling and condensation heat exchangers is far from well-understood [1].

The TPTHEx is chiefly used for heat recovery from sewage or exhaust gases through the vaporisation of liquids at low temperatures. The TPTHEx protects installations against corrosion during the combustion of sulphured fuels because it is possible to select a working fluid and pressure in such that the boiling temperature of the working fluid will always be higher than that of the exhaust gas's dew point. In other words, if the temperature of the exhaust gases is lower than the temperature of the dew point, the TPTHEx operation stops. Used in heat recovery from sewage, the TPTHEx stops sewage from freezing at the evaporator outlet and, due to its double wall design, protects the heating installation from contamination. The TPTHEx can serve as a preheater and vaporiser of liquids at low temperatures, with vapour serving as the heating medium. Special care is required to prevent the freezing of the condensate, which flows inside the tubes of the evaporator. It is possible to select a working fluid and pressure inside the shell such that the boiling temperature of the working fluid will always be higher than the freezing temperature of the condensate.

The two-phase thermosyphon (TPT) operates as follows: heat is supplied to the heating zone; the working fluid starts boiling and produces vapour, which moves to the condensing zone, where it loses heat; lastly, due to gravity, the condensate returns to the evaporator such the evaporation-condensation heat transfer cycle may be repeated. A characteristic feature of the TPT is that it operates as a thermal diode. This property means that the heat can be transported only in one direction – from the evaporator to the condenser. Two-phase thermosyphons can be divided into two main groups: those with single tubes for a countercurrent flow of liquid and vapour [2–4] and those with two-phase loops in which the evaporator is connected to the condenser (always above the evaporator) by a riser and a downcomer [5, 6]. In vapour-dynamic thermosyphons [7], vapour and liquid flows are separated by a wall, and heat transfer is realised in the gap between an inner and an outer tube. Vapour-dynamic thermosyphons and loop heat pipes [8] can provide the coupling between topping and bottoming sorption cycles [7]. In a thermosyphon tube, the heat flux is limited by the counter flows of vapour and condensate [9]. In a two-phase loop, the heat flux is limited by critical heat flux in two-phase flow [10, 11].

The simplest thermosyphon consists of a vertical tube, which is heated and cooled from the outside. This design is a case of lateral heating and cooling of the casing. In another type of TPT the condenser can be situated within the casing, and lateral heating is applied to the casing [12].



In another type of thermosyphon tube, both the condenser and evaporator are placed within the casing. Such a solution allows for the utilisation of enhanced surfaces in the design of condensers and evaporators, such as the proposed TPTHEx.

Recent studies concern miniature thermosyphons used in cooling applications for electronic components and higher heat duty heat exchangers for energy saving or heat recovery.

With regard to the miniature thermosyphons, Jouhara and Robinson [13] tested a short (200 mm), small-diameter (6 mm) thermosyphon with water and three Fluorinert liquids. They established that water outperformed the Fluorinert liquids. Additionally, they found that their calculations of the evaporator section heat transfer coefficient compared well with experimental data, as well as with pool boiling correlations commonly accepted in literature.

Tsoi et al. [14] proposed a new design of a two-phase loop thermosyphon (TPLT) in the form of a thin (200 mm × 200 mm × 3 mm) plate. This TPLT operates horizontally and vertically at sub-atmospheric pressure. The authors proposed a set of correlations for the overall thermal resistance prediction.

Filippeschi [15] tested the operation of a miniature periodic two-phase thermosyphon (PTPT) with the same condenser and accumulator and two evaporator geometries of different internal volume ( $20 \times 10^{-6} \text{ m}^3$  and  $5 \times 10^{-6} \text{ m}^3$ ). A PTPT is a wickless device that can operate opposite gravity. Filippeschi showed that the thermal resistance of a PPT is similar to that of a miniature LHP and during steady state operation equals 0.55 K/W with a heat load of 110 W.

Firouzfard et al. [16] studied thermosyphons that are high heat duty heat exchangers. The authors established that the application of methanol-silver nanofluid as the working fluid in a TPTHEx saves energy by 9–31% for cooling and 18–100% for reheating the air supply stream in an air conditioning system.

Considerations for designing thermosyphons include prediction and control for oscillations encountered during different heat loads. Recently, Khazaei et al. [17] conducted experiments with two 1000 mm copper pipes with 15 and 25 mm inside diameters using methanol as the working fluid to study geyser boiling in a two-phase closed thermosyphon. Their results show that the period of geyser boiling can be decreased by increasing the heat load and aspect ratio and increased by increasing the filling ratio.

Khodabandeh and Furberg [18] examined instabilities in a miniature two-phase loop thermosyphon. The authors established that flow and thermal instability increases as channel height decreases.

The purpose of this paper is to examine the effect of the evaporator tube bundle geometry, the type of tube in the tube bundle (smooth, corrugated and porous coated) and the liquid level above

the top tube row and the type of liquid (water, methanol or R141b) on the overall performance of a TPTHEx.

## **2. EXPERIMENT**

### **2.1. Experimental setup**

The test stand consists of three main systems: the prototype TPTHEx, the heating loop and the cooling water loop. The test facility is capable of determining an overall heat transfer coefficient of the TPTHEx. A diagram of the test stand is shown in Fig. 1. The heating and cooling water loops each contain a centrifugal pump, a flowmeter and a vent tank. A district heating network and a cooling tower are used as a heat source and heat sink, respectively. Heating and cooling water flow rates are controlled by a regulating valve and are measured by a Danfoss MAG 3100 magnetic flowmeter, which is accurate to  $\pm 0.25\%$ . The average temperatures of the heating and cooling water at the inlets and outlets of the TPTHEx evaporator and condenser tube bundles are measured using the Pt100 resistance temperature gauging device with an accuracy of  $\pm 0.1^\circ\text{C}$ .

### **2.2. Prototype two phase thermosyphon heat exchanger**

The prototype two-phase thermosyphon is a shell and tube, horizontal heat exchanger in the form of a welded 1.4404 stainless steel construction. The shell consists of two cylindrical vessels, measuring 159 mm in diameter and 1 m in length, which are connected by two risers and a downcomer – Fig. 2. The evaporator is designed as a tube bundle consisting of 19 smooth, corrugated or porous coated tubes with a triangular arrangement and a pitch equal to  $1.7d$  or  $2.0d$ . Aluminium porous coatings were plasma sprayed. The tested tube characteristics are presented in Table 1. The condenser was designed as a tube bundle consisting of 31 smooth stainless steel tubes (OD 10 mm) with a triangular arrangement and pitch equal to  $1.8d$ . The working fluids are distilled water, methanol and R-141b refrigerant. The experimental investigations were carried out using six TPTHEx prototypes [19].

### **2.3. Experimental procedure**

Before filling the TPTHEx with working fluid, an absolute pressure of 5 kPa was created inside the shell. During the tests, the absolute pressure inside the shell varied from 5 to 20 kPa for the water and methanol and from 90 to 180 kPa for the R-141b refrigerant. The temperature of the intermediate boiling fluid varied from  $48^\circ\text{C}$  to  $62^\circ\text{C}$  for water, from  $24^\circ\text{C}$  to  $32^\circ\text{C}$  for methanol and from  $29^\circ\text{C}$  to  $50^\circ\text{C}$  for R-141b. Heating water and cooling water mass flow rates ranged from 0.3 to 3.5 kg/s. The monitoring of the temperature and pressure reading was facilitated by a PC-aided data acquisition system. All data readings were performed during steady state.



## 2.4. Data reduction

Heat flux transferred in the evaporator was calculated using the formula

$$\dot{q}_{ev} = \frac{\dot{Q}_{ev}}{A_{ev}}, \quad (1)$$

where the heat transfer rate  $\dot{Q}_{ev}$  was estimated using the measured volume flow rate and the **measured** hot water temperatures at the inlet  $\bar{t}_{hf,1}$  and outlet  $\bar{t}_{hf,2}$ :

$$\dot{Q}_{ev} = \dot{V}_{hf} \rho_{hf} c_{hf} (t_{hf,1} - t_{hf,2}). \quad (2)$$

The average outside evaporator tube temperature  $t_{ev,o}$  for the smooth tubes was calculated using the Fourier equation:

$$t_{ev,o} = t_{ev,i} - \frac{\dot{Q}_{ev} \delta_t}{\lambda_t A_{ev}}. \quad (3)$$

The outside temperature for the porous coated tube is assumed to be equal to outer base tube wall temperature [21]. The outside temperature is calculated in the same manner as for smooth tubes. The average temperature  $t_{ev,i}$  inside the evaporator tube was calculated using the Newton equation:

$$\dot{Q}_{ev} = \alpha_{ev,i} A_{ev} (\bar{t}_{hf} - t_{ev,i}), \quad (4)$$

where  $\bar{t}_{hf}$  is an arithmetic mean of the measured inlet and outlet hot fluid temperature

$$\bar{t}_{hf} = \frac{t_{hf,1} + t_{hf,2}}{2} \quad (5)$$

The average heat transfer coefficient  $\alpha_{ev,i}$  inside the single phase flow of hot water was calculated using the Michejev or hde Metallwerk GmbH correlation – Table 2.

The average heat transfer coefficient during the boiling of fluid on the evaporator tube bundle  $\alpha_{ev,o}$  was calculated as

$$\alpha_{ev,o} = \frac{\dot{q}_{ev}}{\Delta T_{ev}}, \quad (6)$$

where the wall superheat is defined as

$$\Delta T_{ev} = t_{ev,o} - t_f. \quad (7)$$

The average outside evaporator tube temperature  $t_{ev,o}$  was calculated using formula (3) and the temperature of the intermediate working fluid  $t_f$  was measured in two places below the evaporator tube bundle and calculated as an arithmetic mean.

The same procedure was applied for the condenser data reduction.

The overall heat transfer coefficient for the evaporator  $k_{ev,exp}$  was calculated as

$$k_{ev,exp} = \frac{\dot{Q}_{ev}}{A_{ev} (\bar{t}_{hf} - t_f)}. \quad (8)$$

The overall heat transfer coefficient for the condenser  $k_{c,\text{exp}}$  was calculated as

$$k_{c,\text{exp}} = \frac{\dot{Q}_c}{A_c(t_f - \bar{t}_{cf})}. \quad (9)$$

The overall heat transfer coefficient for the TPThEx  $k_{\text{exp}}$  was calculated as

$$k_{\text{exp}} = \frac{1}{\frac{A_{ev}(\bar{t}_{hf} - t_f)}{\dot{Q}_{ev}} + \frac{A_c(t_f - \bar{t}_{cf})}{\dot{Q}_c}}. \quad (10)$$

The experimental heat transfer rate was estimated as

$$\dot{Q}_{\text{exp}} = \frac{\dot{Q}_{ev} + \dot{Q}_c}{2}. \quad (11)$$

## 2.5. Error analysis

The uncertainties of the measured and calculated parameters were estimated using the mean-square method. The maximum overall experimental heat flux error limits for the evaporator ranged from  $\pm 1.4\%$  (maximum heat flux) to  $\pm 27\%$  (minimum heat flux), while the average evaporator heat transfer coefficient maximum error was estimated at  $\pm 27\%$ , and the in-wall superheat maximum error was estimated at  $\pm 25\%$ .

## 3. Calculation algorithm

The heat transfer rate in the TPThEx prototype can be estimated using the modified Péclet equation

$$\dot{Q}_{\text{calc}} = kA\Delta T_{\text{ref}} = \frac{\Delta T_{\text{ref}}}{R}, \quad (12)$$

where:  $\Delta T_{\text{ref}}$  is the reference temperature difference based on inlet and outlet temperatures of

heating water ( $t_{hf,1}, t_{hf,2}$ ) and cooling water ( $t_{cf,1}, t_{cf,2}$ ) flowing inside the tubes of an evaporator and condenser, respectively, calculated using

$$\Delta T_{\text{ref}} = \frac{(t_{hf,1} + t_{hf,2})}{2} - \frac{(t_{cf,2} + t_{cf,1})}{2}. \quad (13)$$

The thermal resistance across the TPThEx  $R$  is calculated as

$$R = R_{ev} + R_c, \quad (14)$$

where  $R_{ev}$  is the thermal resistance of the evaporator, defined by

$$R_{ev} = \frac{1}{k_{ev}A_{ev}} \quad (15)$$

and  $R_c$  is the thermal resistance of the condenser, defined by

$$R_c = \frac{1}{k_c A_c}. \quad (16)$$

By substituting (15) and (16) into equation (12), one obtains

$$\dot{Q}_{calc} = \frac{1}{\frac{1}{k_{ev} A_{ev}} + \frac{1}{k_c A_c}} \Delta T_{ref}, \quad (17)$$

where  $k_{ev}$  is the overall heat transfer coefficient of the evaporator,

$k_c$  is the overall heat transfer coefficient of the condenser,

and  $A_{ev}, A_c$  are the surface area of the evaporator and condenser, respectively.

The overall heat transfer coefficient of the evaporator was calculated using the equation

$$k_{ev} = \frac{1}{\frac{1}{\alpha_{ev,i} d_{ev,i}} + \frac{1}{2\lambda_w} \ln\left(\frac{d_{ev,o}}{d_{ev,i}}\right) + \frac{1}{\alpha_{ev,o} d_{ev,o}}}, \quad (18)$$

where  $\alpha_{ev,i}$  is the average heat transfer coefficient for water flowing inside smooth or corrugated tubes,

$\alpha_{ev,o}$  is the bundle boiling average heat transfer coefficient,

$\lambda_w$  is the tube wall thermal conductivity and

$d_{ev,i}, d_{ev,o}$  are the inside and outside diameter of an evaporator tube, respectively.

The overall heat transfer coefficient of the condenser was calculated using the equation

$$k_c = \frac{1}{\frac{1}{\alpha_{c,i} d_{c,i}} + \frac{1}{2\lambda_w} \ln\left(\frac{d_{c,o}}{d_{c,i}}\right) + \frac{1}{\alpha_{c,o} d_{c,o}}}, \quad (19)$$

where  $\alpha_{c,i}$  is the average heat transfer coefficient for water flowing inside the smooth tubes, and

$\alpha_{c,o}$  is the bundle condensation average heat transfer coefficient.

A number of equations for calculations of the average heat transfer coefficients of single phase convection, bundle boiling and bundle condensation were tested to correlate the results in [20].

The recommended correlation equations are presented in Table 2.

#### 4. Results and Discussion

Fig. 3 shows the effect of the type of tube surface on evaporator performance during the boiling of R141b refrigerant on the tube bundle with a 1.7d pitch. In this figure, the boiling curve for the porous coated evaporator tubes shifts to the left toward lower superheats. The phenomenon of nucleate boiling on porous coated surfaces commencing at lower wall superheat is known from other studies, such as [21]. Moreover, the porous coating creates a large number of stable, active nucleation sites; increasing the number of active boiling sites results in an improvement in heat

transfer performance. The diameter of the mouth of the pore cavity defines the nucleation radius and therefore the wall superheat at which the cavity becomes activated. Corrugation geometry (Table 1) is not conducive to nucleation, and only insignificant heat transfer performance improvement in the corrugated tube evaporator was recorded.

Figure 4 shows boiling curves of the three tested fluids boiling on the corrugated tube bundle with a 2.0d pitch. The best overall performance of the evaporator was recorded with the distilled water, regardless of tube type or pitch-to-diameter ratio. This phenomenon can be explained primarily by the distinctly higher latent heat value of vaporizing distilled water than in the cases of methanol and R141b refrigerant. During the tests, with the increase of heat duty, operating pressure rose from 9 to 18 kPa for water, from 11 to 20 kPa for methanol and from 99 to 175 kPa for the R-141b refrigerant.

The liquid head is one of the most important evaporator operation parameters and depends on the construction of the evaporator. According to Thome [22] “*an adequate liquid head has to be maintained to obtain predictable performance and to avoid two phase flow oscillations*”. A problem for deeply immersed bundles can be subcooling of the fluid at the bottom of the bundle. Furthermore, the liquid head strongly affects the recirculation of liquid inside a shell and therefore affects the heat evaporator’s transfer performance. Fig. 5 shows the effect of the liquid level above the top tube row on the TPTHEx overall heat transfer coefficient  $k_o$  for three evaporator heat flux values. In this case, the evaporator was comprised of a corrugated tube bundle with a 1.7d pitch and a methanol as the working fluid. The overall heat transfer coefficient increased with heat flux increase for a given liquid level above the top tube row. Regardless of heat flux, the lowest overall heat transfer coefficient value was recorded for the tests with a 5 mm liquid level above the top tube row. An increase in heat flux naturally decreases the liquid level. Thus, when the heat flux was between 20 kW/m<sup>2</sup> and 30 kW/m<sup>2</sup>, the top row of tubes was uncovered and thermally almost inactive. Two upper tube rows were uncovered when the heat flux was at 40 kW/m<sup>2</sup>, and this uncovering resulted in a dramatic decrease in the overall heat transfer coefficient for the 5 mm liquid level above the top tube row (point A in Fig. 5).

Tests with a 25 mm liquid level above the top tube row and three values of applied heat flux yielded an overall heat transfer coefficient that was higher than for those with a 5 mm liquid level above the top tube row but was lower than for tests with a 15 mm liquid level above the top tube row. In the case of the 25 mm liquid level above the top tube row and the highest heat flux (40 kW/m<sup>2</sup>), all of the rows of tubes were submerged. Despite this finding, the recirculation of liquid inside the evaporator shell was more restrained than in the case of the 15 mm liquid level above the top tube row. Therefore, the 15 mm liquid level above the top tube row appears to be





optimal for the TPThEx evaporator with corrugated tubes when using methanol as the working fluid and applying the three tested heat fluxes.

Bundle boiling heat transfer is enhanced by nucleate boiling, where rising and expanding bubbles together with convective effects produce greater turbulence and thus increase fluid recirculation. However, the increased nucleation ability of porous coating on evaporator tubes may produce too many excessively large bubbles and may thus expose the upper rows to vapour and decrease their heat transfer performance.

Fig. 6 illustrates the effect of an evaporator porous coated tube bundle pitch on the evaporator's overall heat transfer coefficient  $k_{ev,exp}$  during the boiling of distilled water with heat flux  $\dot{q}_{ev}$ . Regardless of heat flux, the highest overall heat transfer coefficient was obtained with the smallest tube pitch, i.e., 1.7d. The same behaviour was observed for the corrugated and smooth tube bundles and other working fluids. These results clearly show the influence of convective effects on bundle boiling performance, even in the case of porous coated tubes.

A comparison of the above mentioned analytical predictions and experimental results is displayed in Fig. 7. The discrepancies of approximately 90% of the experimental points in relation to values calculated according to Eq. (11) are in the region of  $\pm 40\%$ . Considering the broad range of investigated parameters (three types of boiling surfaces, three working fluids, two pitch values) and the fact that the study involved boiling and condensation simultaneously, we consider the agreement between experimental and predicted values obtained by this study to be quite reasonable.

## 5. Conclusion

- A special design of a two-phase thermosyphon heat exchanger (TPThEx), particularly for heat recovery from sewage or exhaust gases, has been proposed.
- The stable performance of the two-phase thermosyphon heat exchanger was recorded for three working fluids and three liquid levels above the top tube row.
- The application of porous coated tubes results in better heat transfer characteristics of the tested two-phase thermosyphon heat exchanger.
- When low wall superheat is preferable, the best option is to use a porous coated tube bundle, with R-141b refrigerant serving as the working fluid, but for higher wall superheats, better heat transfer coefficients were obtained using water because of its different boiling regime.
- Regardless of tube type, the highest heat flux transfers were observed using the smallest tube pitch examined, i.e., 1.7d.
- A modified Péclet equation has been proposed for the calculation of the TPThEx heat transfer rate.

## Nomenclature

$A$	heat transfer area	[m <sup>2</sup> ]
$c_p$	specific heat	[J/kgK]
$d$	diameter	[m]
$g$	acceleration due to gravity	[m/s <sup>2</sup> ]
$k$	overall heat transfer coefficient	[W/m <sup>2</sup> K]
$p$	pressure	[Pa]
$\dot{Q}$	heat transfer rate	[W]
$\dot{q}$	heat flux	[W/m <sup>2</sup> ]
$r$	latent heat of evaporation	[kJ/kg]
$s$	pitch	[m]
$t$	temperature	[°C]
$\alpha$	heat transfer coefficient	[W/m <sup>2</sup> K]
$\mu$	viscosity	[Pa s]
$\lambda$	thermal conductivity	[W/mK]
$\rho$	density	[kg/m <sup>3</sup> ]
$\sigma$	surface tension	[N/m]

## Subscript

$c$	condenser
$cf$	cold fluid
$ev$	evaporator
$exp$	experimental
$f$	intermediate working fluid
$hf$	hot fluid
$i$	inside
$o$	outside
$ref$	reference
$t$	tube
$w$	wall
1	inlet
2	outlet

## Acknowledgments

The authors wish to acknowledge the generous support provided by SECESPOL Ltd., Gdańsk, Poland for producing the prototype two-phase thermosyphon heat exchangers.



## References

- [1] L.S. Pioro, I.L. Pioro, *Industrial Two-Phase Thermosyphons*, Begell House Inc., New York, Wallingford (UK) 1997.
- [2] M. Bezrodny, J. Goscik, *Thermosyphon Heat Exchangers, Refrigeration & Air-Conditioning Engineering* 1 (1997) 5–10 (in Polish).
- [3] D. Chisholm, *Heat Exchangers Design Handbook, Part 3, Thermal and Hydraulic Design of Heat Exchangers, Chapter 3.10.1.*, Begell House Inc., New York, Wallingford (UK) 1998.
- [4] S. Khandekar, M. Groll M, *Insights into the Performance Models of Closed Loop Pulsating Heat Pipes and Some Design Hints*, Proc. 18<sup>th</sup> National & 7<sup>th</sup> ISHMT-ASME Heat and Mass Transfer Conference, IIT Guwahati, India (2006) Paper No: G-440.
- [5] N. Gavotti, F. Polásek, *Thermal Control of Electronic Components by Means of Two-Phase Thermosyphons*, Proc. of Eurotherm Seminar No. 6, Single and Two-Phase Natural Circulation. Genoa, Italy (1999) 229–238.
- [6] R. Khodabandeh, B. Palm, *An Experimental Investigation of the Influence of System Pressure on the Boiling Heat Transfer Coefficient in Closed Two-Phase Thermosyphon Loop*, Proc. of the 5<sup>th</sup> ExHFT World Conference, Thessaloniki, Greece (2001) 191–196.
- [7] L.L. Vasiliev, *Heat pipes in modern heat exchangers*, *Applied Thermal Engng* 25 (2005) 1–19.
- [8] L.L. Vasiliev, *Micro and miniature heat pipes – Electronic component coolers*, *Applied Thermal Engng* 28 (2008) 266–273.
- [9] M. Monde, *Analytical study of critical heat flux in two-phase thermosyphon: relationship between maximum falling liquid and critical heat flux*, *ASME J. Heat Transfer* 118 (1996) 422–428.
- [10] A.I. Leontiev, O.O. Milman, V.A. Fedorov, *Ultimate loads with water boiling in the vertical channels under natural circulation conditions*, *J. Engng Physics* 48 (1985) 621–628.
- [11] A. Baars, A. Delgado, *Multiple modes of a natural circulation evaporator*, *J. of Heat Mass Transfer* 49 (2006) 2304–2314.
- [12] F.M. Chernomurov, *Operational Principle and Potential Application of Condensation-gas Cooling Apparatuses*, *J. Engineering Physics and Thermophysics* 36 (1979) 1113–1114 (in Russian).
- [13] H. Jouhara, A.J. Robinson, *Experimental investigation of small diameter two-phase closed, thermosyphons charged with water, FC-84, FC-77 and FC-3283*, *Appl. Therm. Eng.* 30 (2010) 201–211.



- [14] V. Tsoi, S.W. Chang, K.F. Chiang, C.C. Huang, Thermal performance of plate-type loop thermosyphon at sub-atmospheric pressures, *Appl. Therm. Eng.* 31 (2011) 2556–2567.
- [15] S. Filippeschi, Comparison between miniature periodic two-phase thermosyphons and miniature LHP applied to electronic cooling equipment, *Appl. Therm. Eng.* 31 (2011) 795–802.
- [16] E. Firouzfar, M. Soltanieh, S.H. Noie, S.H. Saidi, Energy saving in HVAC systems using nanofluid, *Appl. Therm. Eng.* 31 (2011) 1543–1545.
- [17] I. Khazaei, R. Hosseini, S.H. Noie, Experimental investigation of effective parameters and correlation of geysers boiling in a two-phase closed thermosyphon, *Appl. Therm. Eng.* 30 (2010) 406–412.
- [18] R. Khodabandeh, R. Furberg, Instability, heat transfer and flow regime in a two-phase flow thermosyphon loop at different diameter evaporator channel, *Appl. Therm. Eng.* 30 (2010) 1107–1114.
- [19] J.T. Cieśliński, A. Fiuk, Thermosyphon Heat Exchanger, Polish Patent PL 192757 (2006).
- [20] A. Fiuk, Influence of geometrical and thermophysical parameters on two-phase thermosyphon performance, PhD thesis, GUT, Gdansk, Poland (2009) (in Polish).
- [21] J.T. Cieśliński, Nucleate pool boiling on porous metallic coatings *Experimental Thermal and Fluid Sci.* 25 (2002) 557–564.
- [22] J.R. Thome: Enhanced boiling heat transfer. Hemisphere, NY, 1990, p. 284
- [22] M.G. Cooper, Heat Flow in Saturated Nucleate Pool Boiling – A Wide-Ranging Examination Using Reduced Properties. *Advances in Heat Transfer* 16 (1984) 157–239.
- [23] I.L. Mostinski, Application of the rule of corresponding states for the calculation of heat transfer critical heat flux. *Teploenergetika*, 4 (1963) 66–71 (in Russian).
- [24] K. Krasowski, J.T. Cieśliński, Heat transfer during pool boiling of water, methanol and R141b on porous coated horizontal tube bundles. *HEAT 2011, The 6<sup>th</sup> International Conference on Transport Phenomena in Multiphase Systems* June 28 – July 2, 2011, Ryn, Poland, 279–284.
- [25] W. Nusselt, Steam condensation. *Zeitschr. Ver. deutsch. Ing.* 60 (1916) 542–546 and 569–575 (in German).
- [26] K. Gutkowski, Refrigeration – selected numerical problems. WNT, Warsaw, 1972 (in Polish).
- [27] M.A. Michejev, Fundamentals of heat transfer. State Power Energy Publishers, Moscow, 1949 (in Russian).
- [28] Heat transfer technology information. Heat transfer during single phase fluid flow through twisted tubes. hde Metallwerk GmbH, Menden, Germany, 1994 (in German).



## Figure captions

Fig. 1. Schematic view of the experimental setup

Fig. 2. Axonometric view of the prototype TPThEx; 1 – evaporator, 2 – condenser, 3 – riser, 4 – downcomer

Fig. 3. Boiling curves of R141b on tube bundles: o – porous coated tubes, □ – corrugated tubes, Δ – smooth tubes

Fig. 4. Effect of various working fluids on evaporator performance (corrugated tubes); Δ – water, o – R141b, □ – methanol

Fig. 5. Effect of fluid head on TPThEx overall heat transfer coefficient (methanol, corrugated tubes, 1.7 d)

Fig. 6. Effect of tube pitch on overall heat transfer coefficient during boiling of water on porous coated tube bundle; a) evaporator, b) thermosyphon heat exchanger; pitch: o – 2.0 d, Δ – 1.7 d

Fig. 7. Heat transfer rate in TPThEx – a comparison of predicted and experimental data; o – R141b, □ – methanol, Δ – water

## Table captions

Table 1. Characteristics of the tested tubes

Table 2. Recommended correlation equations

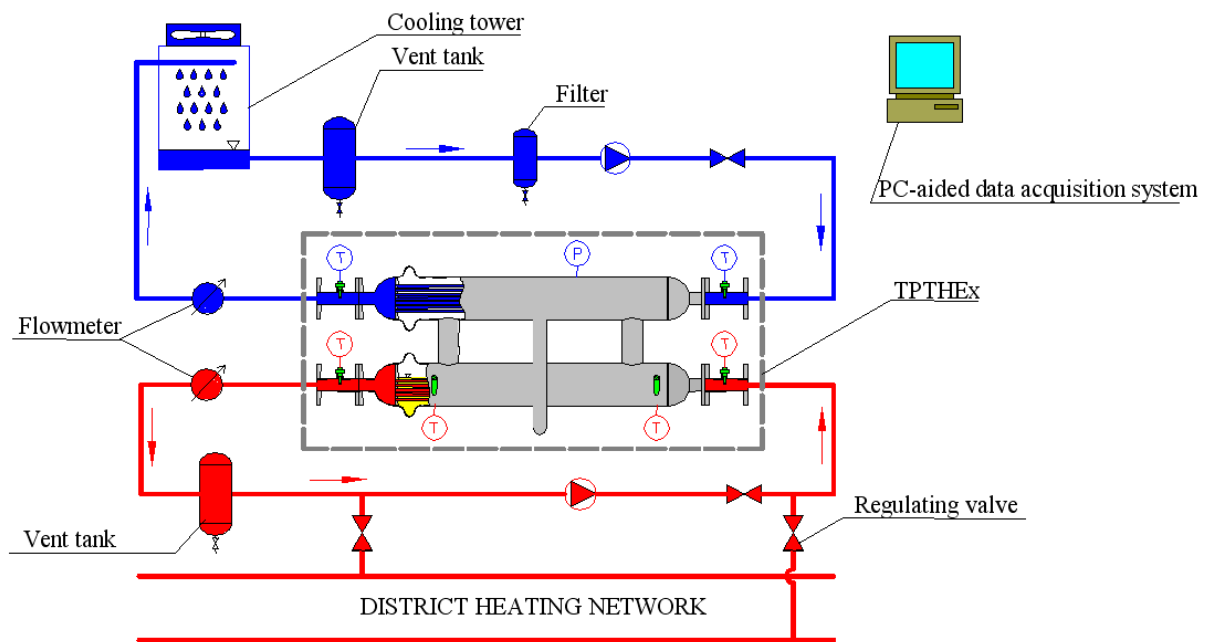

Fig. 1. Schematic view of the experimental setup

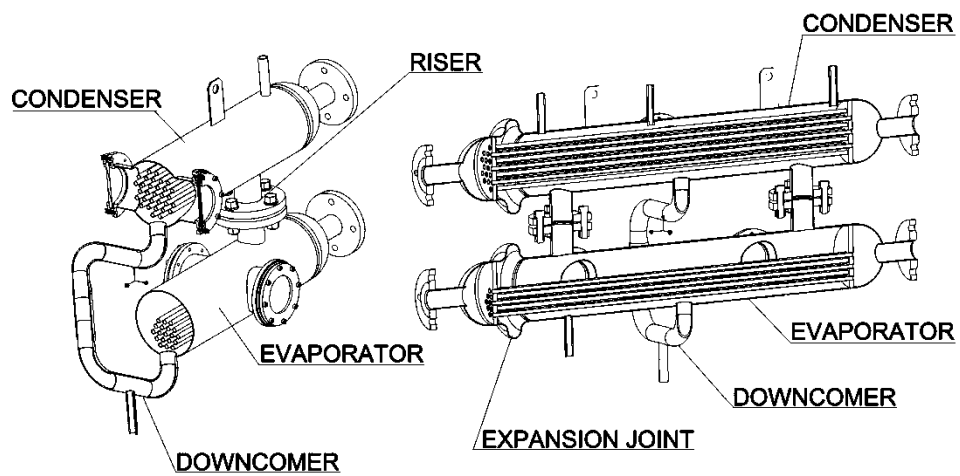

Fig. 2. Axonometric view of the prototype TPTHEx

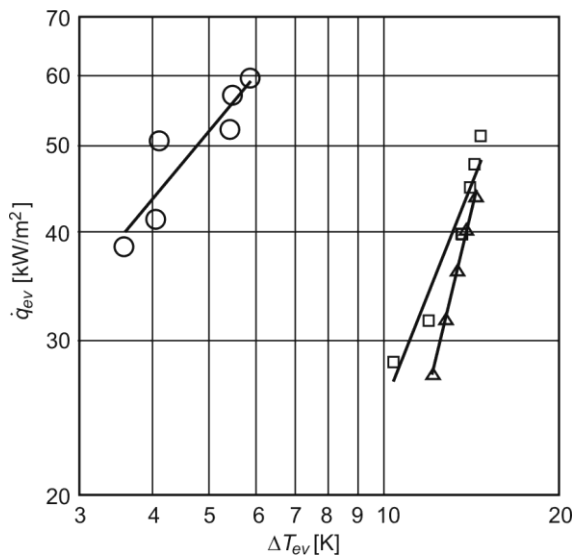

Fig. 3. Boiling curves of R141b on tube bundles: o – porous coated tubes, □ – corrugated tubes, Δ – smooth tubes

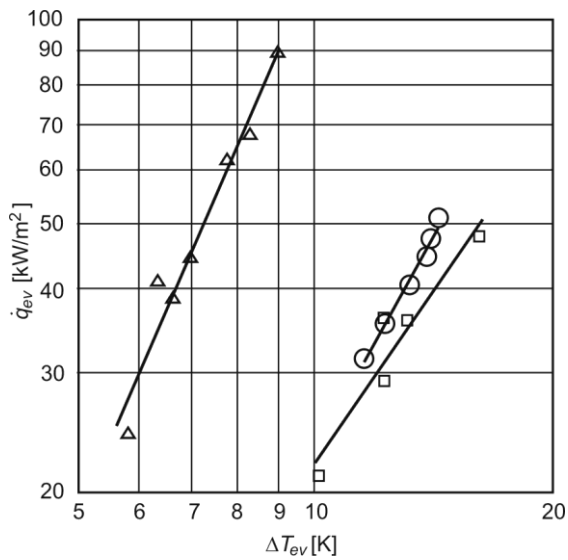

Fig. 4. Effects of various working fluids on evaporator performance (corrugated tubes); Δ – water, o – R141b, □ – methanol

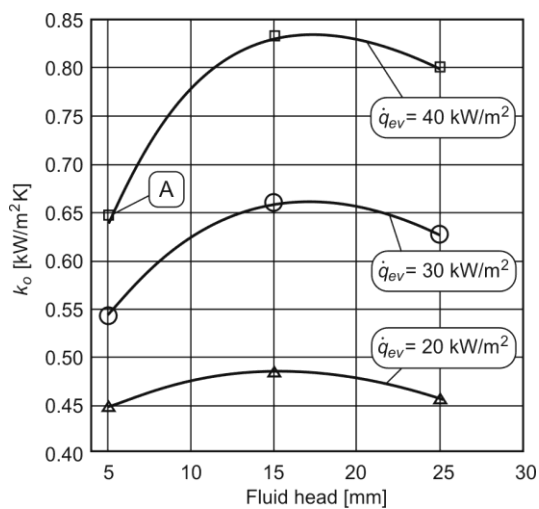

Fig. 5. Effect of fluid head on TPTHEx overall heat transfer coefficient (methanol, corrugated tubes, 1.7 d)

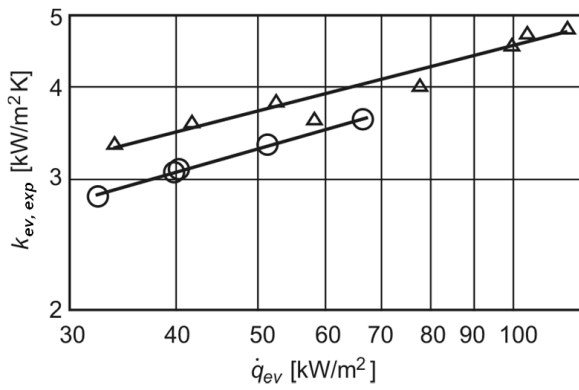

Fig. 6. Effect of tube pitch on evaporator overall heat transfer coefficient during boiling of water on porous coated tube bundle; pitch: o – 2.0 d,  $\Delta$  – 1.7 d

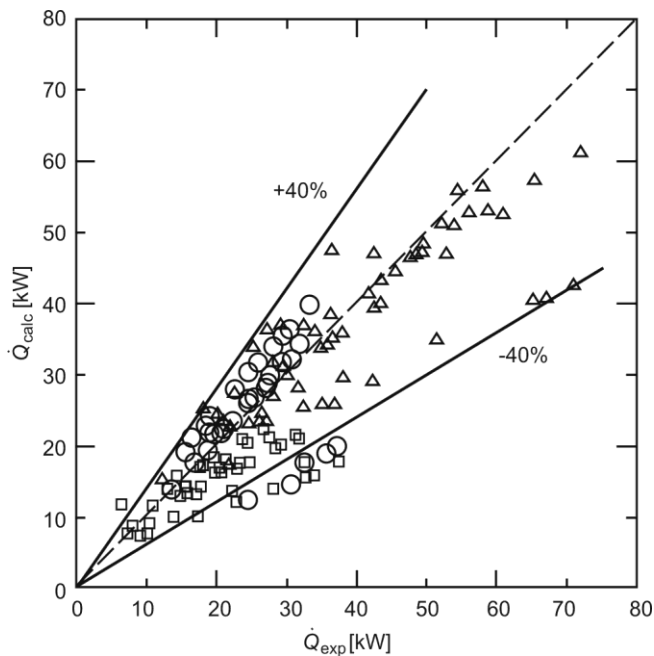

Fig. 7. Heat transfer rate in TPThEx – a comparison of predicted and experimental data; o – R141b,  $\square$  – methanol,  $\Delta$  – water



Table 1. Characteristics of the evaporator tested tubes

Tube	OD / wall thickness	Corrugation depth / porous layer thickness	Material	Other
smooth	10 mm / 0.6 mm	–	1.4404	seamed
corrugated	10 mm / 0.6 mm	0.45 mm	1.4404	seamed, three-helix corrugation, pitch 18±0.5 mm
porous coated	10 mm / 0.6 mm	0.15 mm	1.4404 / aluminium	porosity – 41 % average pore radius – 2.77 µm

Table 2. Recommended correlation equations

Heat transfer process	Working fluid	Recommended correlation	Author
boiling on smooth and corrugated tube bundle	water	$\alpha = \beta 55 p_r^{0.12-0.4343 \ln R_p} (-0.4343 \ln p_r)^{-0.55} M^{-0.5} \dot{q}^{0.67}$ $\beta = 1.7 \text{ for water}$	Cooper [22]
	methanol		
	refrigerant	$\alpha = 0.00417 \dot{q}^{0.7} p_{cr}^{0.69} F_p$ $F_p = 1.8 p_r^{0.17} + 4 p_r^{1.2} + 10 p_r^{10}$	Mostinski [23]
boiling on porous coated tube bundle	water	$Nu = 521.7 Bo^{0.305} \left( \ln \frac{p}{p_{cr}} \right)^{-1.48} \left( \frac{s}{d} \right)^{0.74} Pr^{0.67}$ $Nu = \frac{\alpha d}{\lambda_l}, Bo = \frac{\dot{q} La \rho_l}{\rho_v r \mu_l}, La = \sqrt{\frac{\sigma}{g(\rho_l - \rho_v)}}$	Ciesliński and Krasowski [24]
	methanol		
	refrigerant		
condensation on tube bundle	water	$Nu = 0,72 (Ga Pr K)^{0.25}, Ga = \frac{g \rho_l (\rho_l - \rho_v) d^3}{\mu_l^2}, K = \frac{r}{c_p \Delta T_s}$	Nusselt [25]
	other liquids	$\alpha = \beta 6.44 A \left( \frac{r}{(t_l - t_{sat}) d} \right)^{0.25}, A = \left( \frac{\rho^2 \lambda_l^3 g}{\mu_l} \right)$	Gutkowski [26]
single phase convection inside smooth tubes	all liquids	$Nu = 0.021 Re^{0.8} Pr^{0.4}$	Michejev [27]
single phase convection inside corrugated tubes	water	$Nu = 0.03 Re^{0.8} Pr^{0.4}$	hde Metallwerk GmbH [28]