

State and Control System Variables Sensitivity to Rotor Asymmetry in the Induction Motor Drive

Piotr Kołodziejek

Faculty of Electrical and Control Engineering
Gdańsk University of Technology, Narutowicza 11/12, 80-233, Gdańsk, Poland
E-mail: pkolod@ely.pg.gda.pl

Abstract

Purpose – analysis and comparison of the closed-loop and sensorless control systems sensitivity to the broken rotor for diagnostic purposes. For the same vector control system induction motor drive analysis concerning operation with the asymmetric motor, broken rotor fault handling and operation were investigated. Reliability, range of stable operation, fault symptoms and application of diagnosis methods based on control system variables utilization was analyzed.

Design/methodology/approach – induction motor drive vector control system synthesis was applied using the multiscalar variables of the machine model with nonlinear feedback linearization applied to use classical cascaded PI controllers for the speed-torque and flux decoupled control. Speed observer was applied for the rotor flux and rotor speed estimation for the sensorless control system synthesis.

Findings – Relative sensitivity of the state and control system variables to broken rotor fault based on experimental results for the closed-loop and sensorless control systems is presented and compared. Drawbacks of using the MCSA analysis for the rotor fault diagnosis in the closed-loop and sensorless control systems are pointed. Advantages and drawbacks of the state space estimators filtering characteristics in the sensorless control system are described.

Practical implications – asymmetric IM motor drive handling and diagnosis. Broken rotor range diagnosis inconsistency using the popular MCSA method should be considered in the closed-loop and sensorless control system of the induction motor drive. Depending on the IM motor drive application and the operation requirements the results can be used for asymmetric machine proper handling, choosing proper control system structure and control system variables for rotor fault early diagnosis.

Originality/value – sensitivity of the state and control system variables to broken rotor fault based on experimental results for the closed-loop and sensorless control systems is presented, which implies motor handling procedures and fault diagnosis.

Keyword(s): Induction motor drive, Broken rotor handling and diagnosis, Sensorless control, Closed-loop control, Fault symptoms sensitivity analysis

Article Type: Research paper

1. Introduction

Sensorless controlled induction motor drives are more and more popular in industrial applications, particularly in the renewable energy processing i.e. wind power plants, small water power plants and electric vehicles. Nowadays electric drives need to provide additional functions besides their primary task. One of them is online diagnostics during normal operation and on-line drive state estimation. Increasing computational power of the DSP processors allows for on-line diagnostic functions implementation besides control and estimation algorithms. Early fault symptoms detection, isolation and identification processes are needed for critical fault and emergency shutdown prevention, providing remote information sending to the service. Rotor asymmetry in the early stage of development often is not a critical fault. Depending on the drive application, different handling functions can be applied. Closed-loop control system may be used in determined limited range for compensating fault symptoms, keeping quality factors close to normal machine asymmetry range, which allows for continuous drive operation. Control system may be used also for reducing drive dynamics in transient states to preserve the fault extension. From economical point of view unexpected failure of induction motor drive may be very expensive and not only in the high power drives applications. Induction motor drives are used also in safety-critical processes and in the production lines. Nowadays overloading capabilities of induction motor drives are used in renewable energy processing and particularly in electric vehicles, where power to mass ratio is an important factor. In this case rotor stress make the fault more probable and need of on-line state monitoring is justified. Practical application of sensorless control system requires analysis of reliability in all possible operational states, including the abnormal states. Control systems synthesis approach is usually based on symmetric machine assumption. Investigation of the diagnosis method proposed in this paper is based on earlier research results reported in (Kolodziejek and Bogalecka, 2009 and 2010). Modelling of the asymmetric IM drive, multiscalar control system and speed observer structure taken into consideration in this paper has been reported in (Krzemiński, 2001 and 2006). Investigation of the rotor asymmetry in IFOC and FOC control system were reported in (Cruz and Cardoso, 2007; Rodriguez-Cortes *et al.*, 2004). This paper presents analysis of rotor asymmetry focused on control system variables and state variables. Next control system controllers parameters influence to rotor asymmetry symptoms in the state variables and control system variables of the induction motor drive has been investigated.

Rotor fault diagnosis in closed-loop with speed measurement and sensorless control system topologies is a complex problem, that requires investigation how state variable estimator parameters, control system parameters and equivalent machine parameters inaccuracy affect the rotor asymmetry symptoms. Machine parameters inaccuracy may be related to applied calculation method and to the change of parameters after the rotor fault developed, unless they are estimated and updated on-line.

2. Sensorless and closed-loop control system experimental analysis with an asymmetric induction machine

Block scheme of the applied sensorless control system is shown in fig. 1. For closed-loop operation the difference is only in speed measurement source (encoder). For the experimental investigation of the diagnosis method for variable-speed drive, both for open and closed loop operation, multiscalar control system has been taken into consideration, where control rules are calculated using multiscalar variables. The control system is reference frame independent and can be treated as generalized vector control of the induction machine as reported in (Krzemiński 2001).

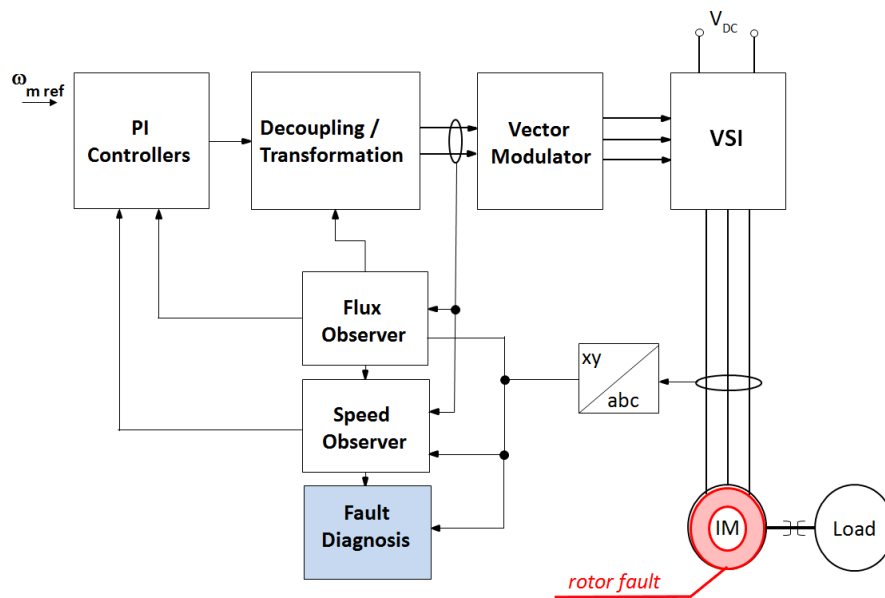

Fig.1. Sensorless control system of induction machine.

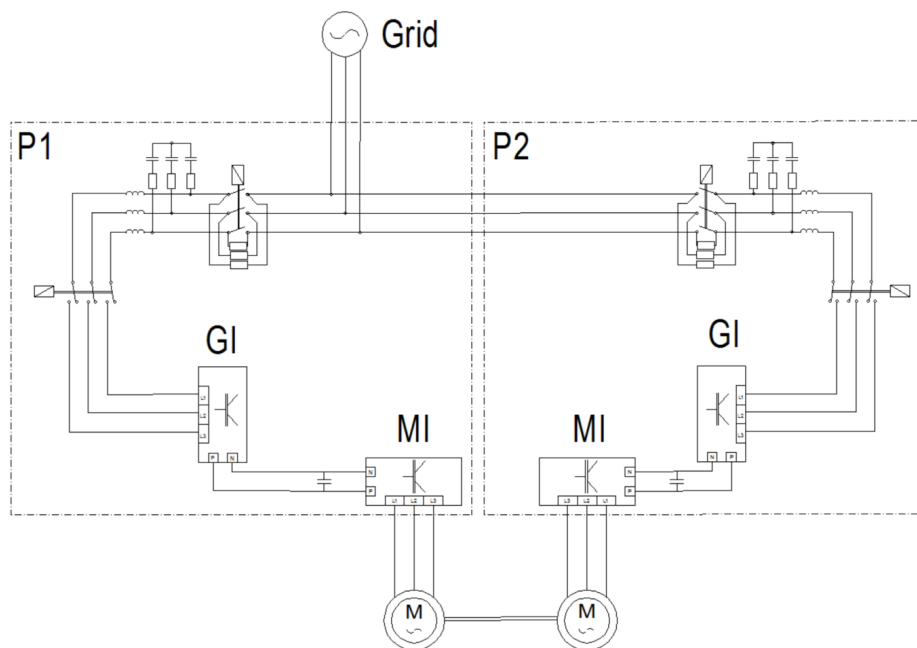

Fig. 2. Scheme of the experimental setup.



Figure 3: Broken rotor bars and central end ring.

Experimental setup consist of two induction motor machines, two power converters including grid inverter and machine inverter as presented in fig. 2. Induction machines are fed with the voltage source inverters based on IGBT transistors, which provide bidirectional energy transmission. The shaft is equipped with a 10-bit absolute encoder for comparison sensorless and closed-loop control systems operation performance. One IM drive operate with machine with broken rotor, while the second is used for load torque generation.

The most popular method of broken rotor diagnosis known in the literature as the MCSA of broken rotor with 2 broken bars were is based on phase current harmonic analysis, so modern oscilloscopes are standard equipped with this tool. Different quality oscilloscopes were used to investigate using this method for broken rotor diagnosis in the closed-loop and sensorless control system. In this case analysis conducted. Some problem was a non-typical rotor with additional central ring, which is rarely met in low power induction machines as presented in fig 3. Empty spaces were filled with non-conductive material for mass balance preservation. In fig. 4 the closed-loop operation of the drive at nominal speed for the induction machine with broken rotor is presented. Increasing load torque causes change of voltage supply frequency that exceeds the nominal value. This is caused by control system which increase voltage supply frequency too keep reference speed constant, after the slip increased. Voltage supply frequency exceeds nominal value due to broken rotor of the induction machine. Obtaining high resolution stator current spectra can be achieved by setting the lowest acceptable value of the Nyquist frequency (65,1 Hz as shown in fig. 4). Using standard quality oscilloscope the spectra

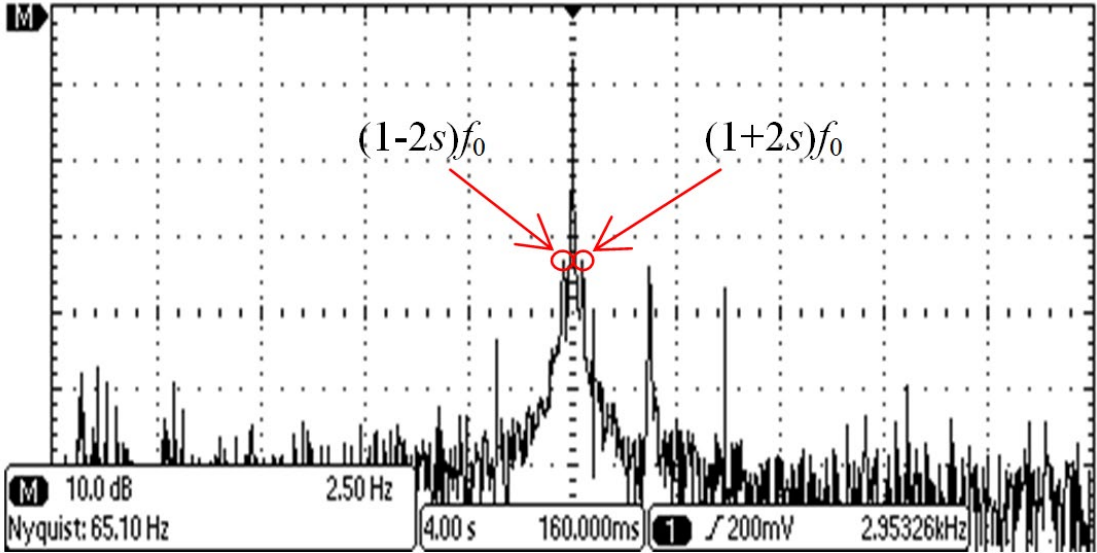

a)

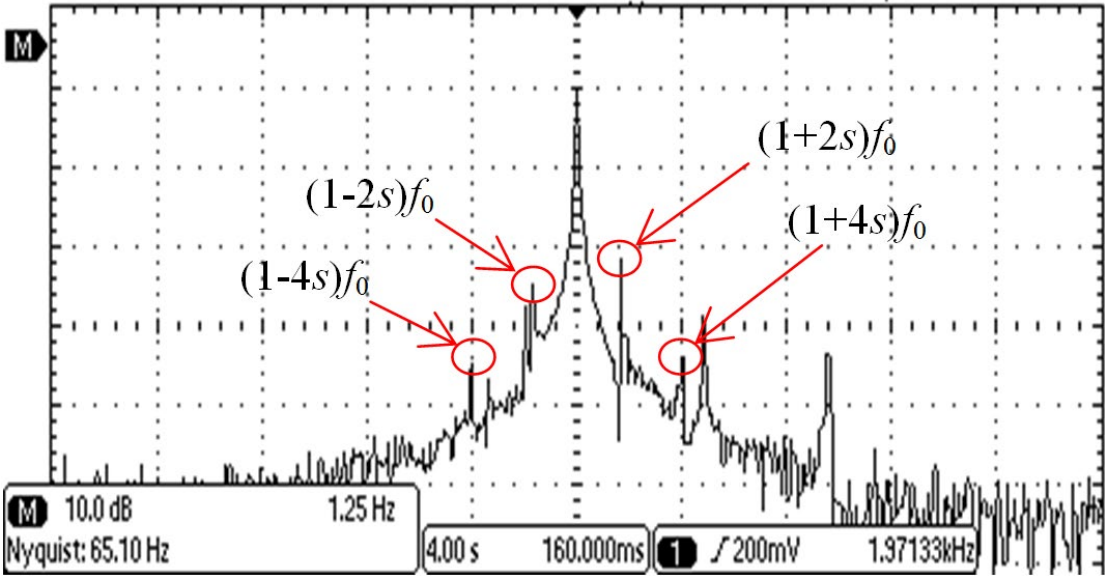

b)

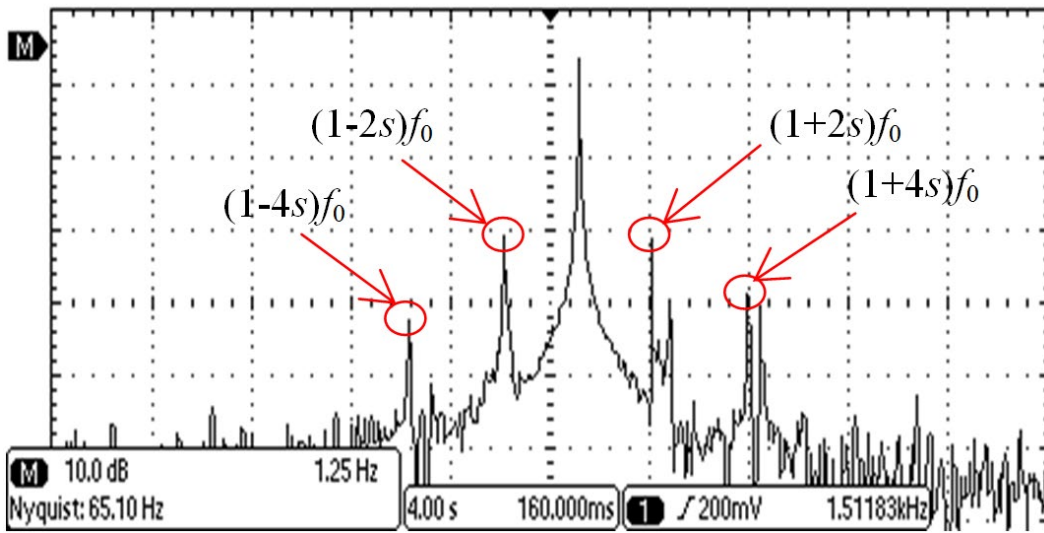

c)

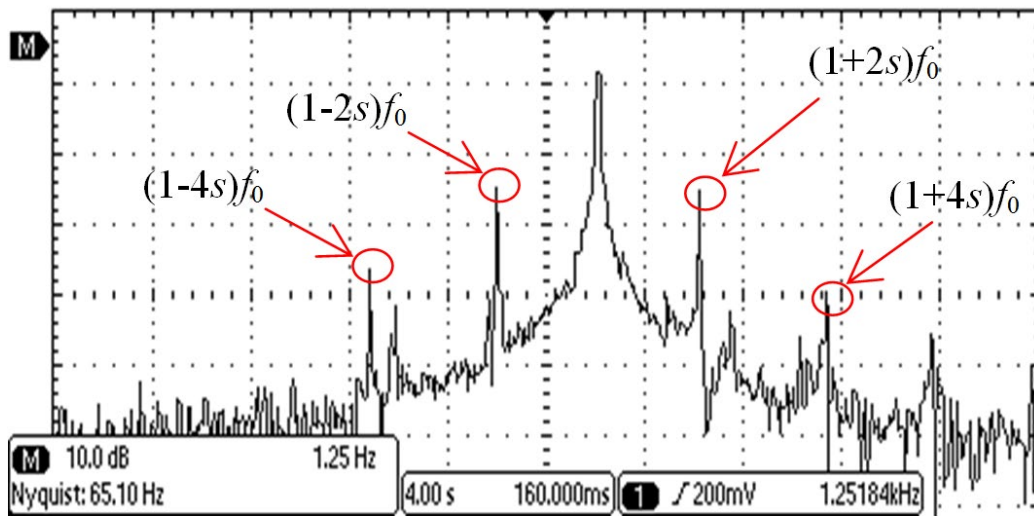

d)

Fig. 4. FFT analysis for the stator current spectra at nominal speed and a) $T_L=0$; b) $T_L=0,3$ a) $T_L=0,5$ a) $T_L=0,65$.

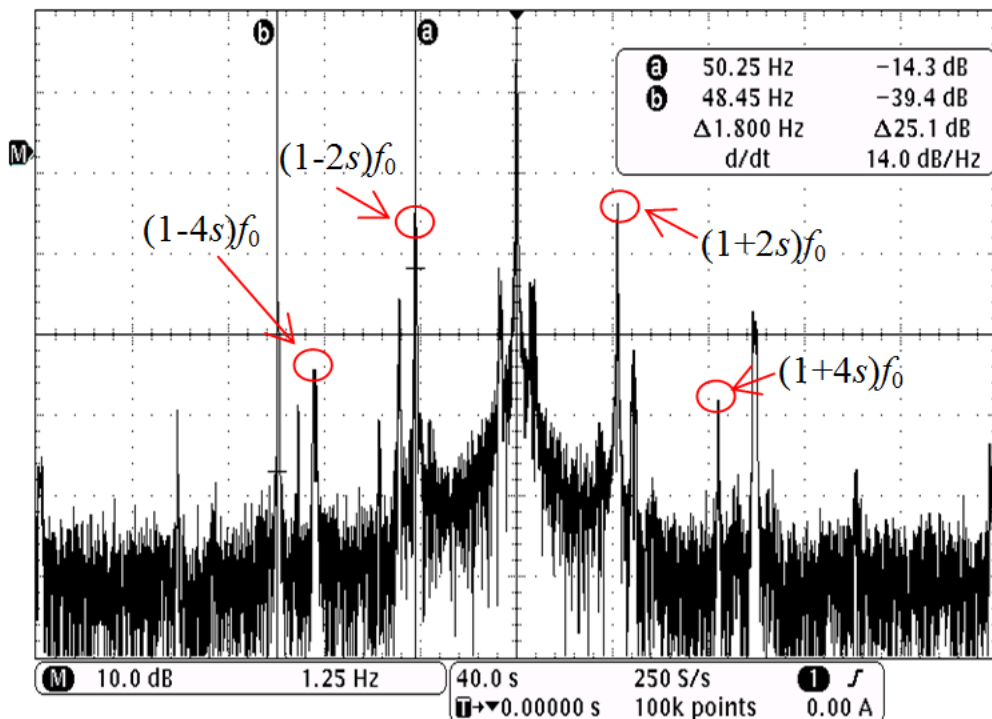

Fig. 5. Harmonic FFT stator phase current analysis at nominal speed.

resolution is relatively poor, but is enough for band frequency observation related to broken rotor with their damped stator-rotor reflections. Observability of the reflections depends on the inertia which affects low frequency oscillations of the rotor speed.

Using high-end oscilloscope for stator current spectra calculations using FFT as shown in fig. 5 gives higher resolution spectra, where another harmonic related to different phenomena such as eccentricity, mechanical vibration, load torque pulsation are visible. This phenomena may be reason of additional problems concerning isolation of broken rotor harmonics from others, which are close or in some cases equal to analysed harmonics and need to be decoupled. In characteristic points, where rotor fault harmonics interfere with others, they can be decoupled by changing operation point of the drive. Important drawbacks of using this most popular method for broken rotor diagnosis are the cost of high quality equipment for measurements, very long measurement time (up to a few minutes) for low frequency discrimination spectra resulting in need of keeping steady state during the measurement process for spectra calculation which is in industrial conditions often difficult to fulfill. Other drawback is a need of human expert in the diagnosis process, where analysis may be inequivalent due to interferences and diagnosis cannot be done continuous and on-line. Mentioned drawbacks justify a need of developing on-line universal diagnosis methods for closed-loop and sensorless control for steady state operation and during transient states, where fault symptoms become nonstationary. Characteristic harmonic sidebands are visible in the phase stator current spectra in closed loop and sensorless estimation how control system affects the operation, but after calculation of sideband frequency the diagnostic reasoning based only on the difference between fundamental supply voltage harmonic amplitude and the sideband amplitude will not be reliable without sidebands.

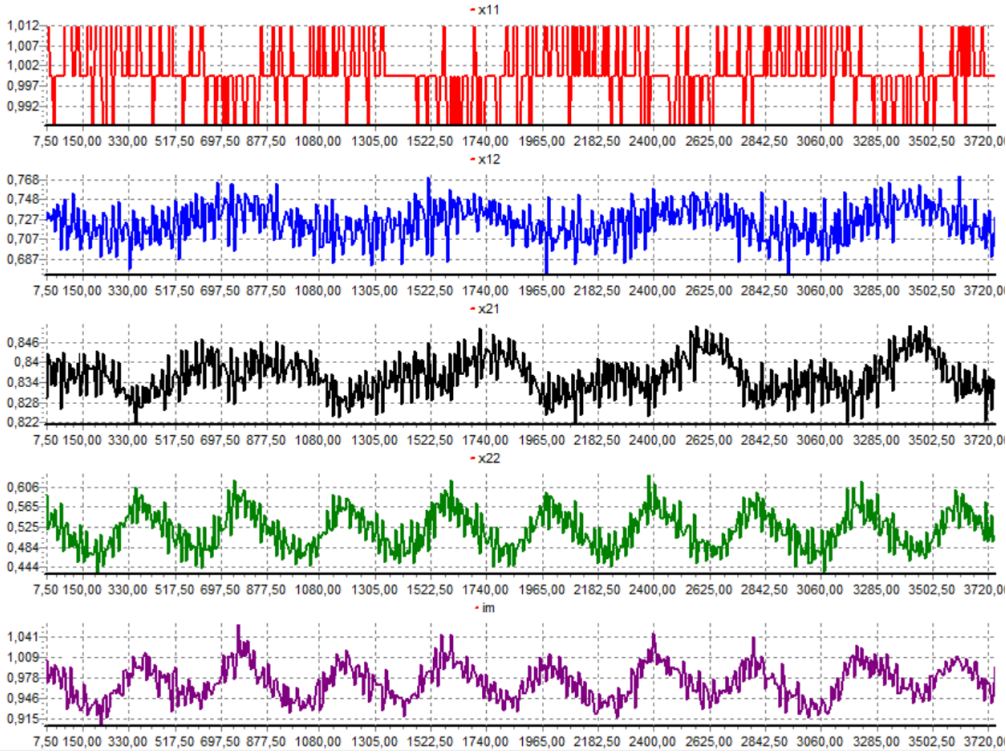

Fig. 6. Closed-loop operation of IM drive with encoder for speed measurement and 2 broken rotor bars.

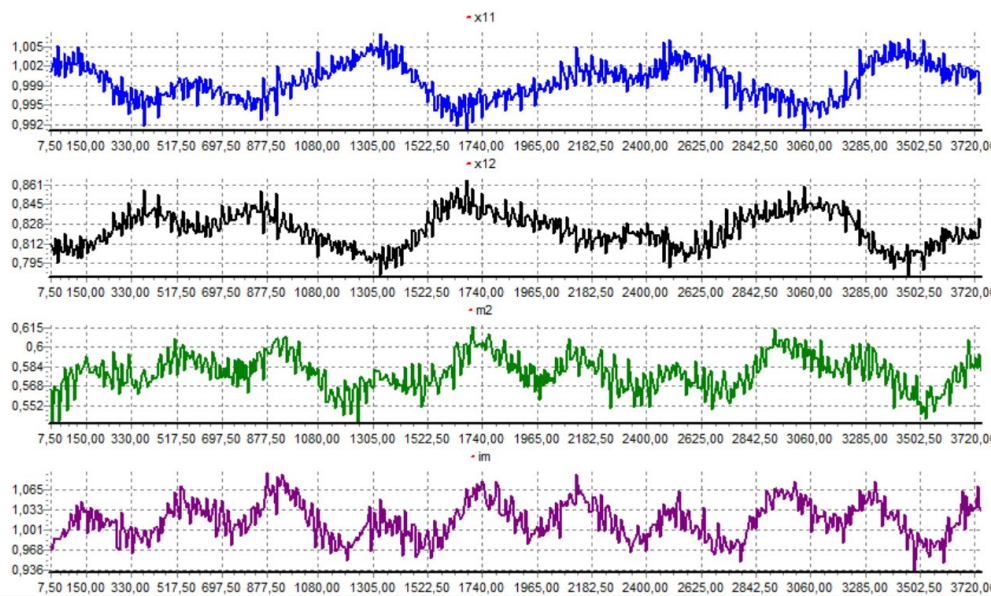

Fig. 7. Sensorless operation of the IM drive and 2 broken rotor bars.

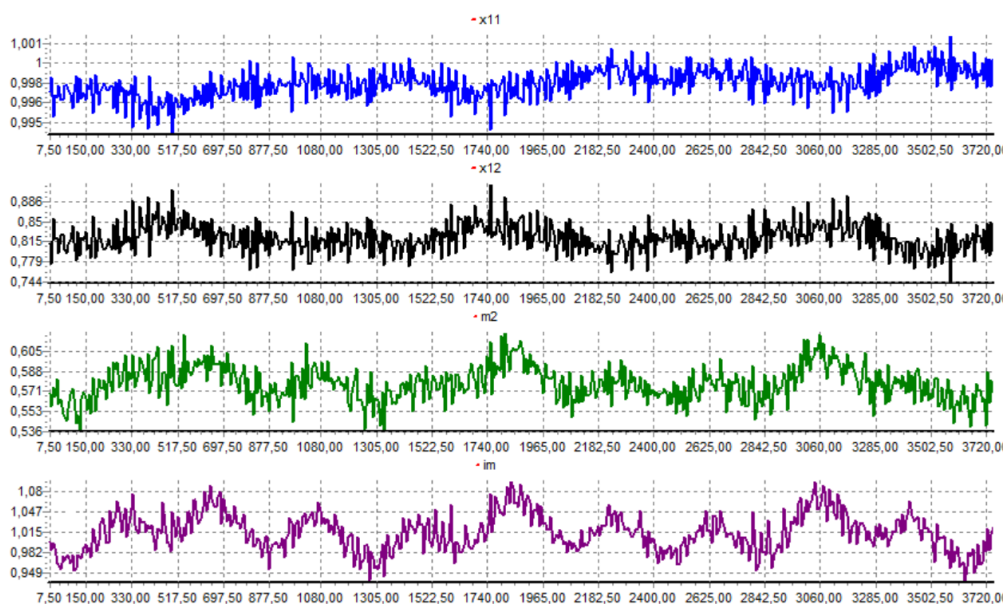

Fig. 8. Sensorless operation of IM drive with 2 broken rotor bars and optimized controllers parameters for speed oscillations compensation.

Comparison of measurements for closed-loop and sensorless operation using DSP controller is presented in fig. 6 and 7. Using speed observer reported in [3] for rotor speed and flux estimation in sensorless operation provides IM drive performance score surpassing the score for operation with closed-loop control system based on encoder measurement. Using 10-bit encoder for speed measurement as shown in fig. 6. at nominal speed operate with resolution giving approx. 1% measurement error, while speed observer estimates speed pulsation related to broken rotor inside the 1% error as shown in fig. 7. This limitation however can be improved by choosing a higher resolution encoder, but too high resolution will give very high frequency pulses for high speed operation range, where processing such signals can make additional problems depending on used electronic equipment. Some encoders can make electromagnetic compatibility problems, where signal noise can be difficult to filter out, however it is not always encoder responsible for such problems.

In the figures 7 and 8 comparison of the drive operation with different tuning of the multiscalar control system controllers is presented. In fig. 7 parameters were tuned for dynamic states performance. At the sensorless IM drive operation it possible to tune controller parameters in the control system to compensate mechanical variables pulsations as shown in fig. 8, where rotor speed pulsation is hold under 0.5%. Sensorless control system may give even higher accuracy which is limited by LEM measurement converters, which rewinding count is set to avoid saturation during utilization of the

drive overloading capabilities. This is also the reason of a sharp plots presented in zoomed scale for characteristic oscillations related to broken rotor observation.

3. State and control system variables sensitivity to rotor asymmetry analysis

Early stage detection of rotor asymmetry may be crucial for avoiding the drive failure and critical damage. Characteristic feature of broken rotor development is that in many cases in the early stage it is difficult to detect and isolate the fault. But since the first broken bar appears, the neighbouring bars current density is increased making them more vulnerable to brake, and the phenomena increases with the number of broken rotor bars creating the chain of fault development. Thus the earlier the fault is detected the wider space for operation for stopping continuation of the fault development remains. Depending on the application of an IM drive different actions may be applied. One aim is to lower dynamics of the drive by settings limits in the control system and the second is to keep quality factors of the drive performance similar to normal operation state by tuning controllers parameters or applying compensating control algorithm.

For realisation mentioned aims and the earliest rotor fault detection sensitivity of the monitored state and control system variables was investigated for closed-loop and sensorless control systems. Based on the experimental research results for different operation points – rotor speed and load torque the state and control system variables sensitivity was investigated. Results are showed in tabels 1 and 2 calculated as the relative percentage difference of characteristic oscillations related to broken rotor for rotor speed, electromagnetic torque, square rotor flux, so called reactive torque (x_{22}), stator current space vector modulus, new reference control variables after IM model linearization (m_1 , m_2), active and reactive power. The experimental results verified simulations reported in (Kołodziejek and Bogalecka 2009). The most sensitive variables for broken rotor detection are decoupled control variables m_1 and m_2 in both control systems. The electromagnetic torque pulsations related to the broken rotor are better compensated in the sensorless control system, however overall speed pulsations are slightly lower in the closed-loop control system which makes the decoupling control system variables more sensitive to the rotor asymmetry. For the 0.25[p.u.] rotor speed and 0.72[p. u.] load torque the measurements in the closed-loop control system were not possible due to range of x_{12} and x_{11} changes. In this case only sensorless control system retained stability due to its filtering characteristics. The difference in x_{12} for the both control systems is most significant at lower speed, where encoder resolution affects the rotor measurement accuracy. From state variables one of the most interesting result is active and reactive power sensitivity, therefore using this variables is also recommended for the broken rotor early detection.

ω [j.w.]	M_L [j.w.]	x_{11} [%]	x_{12} [%]	x_{21} [%]	x_{22} [%]	i_m [%]	m_1 [%]	m_2 [%]	P_m [%]	Q_m [%]
0,25	0,25	9,39	16,55	2,55	24,84	18,52	160,51	28,96	71,61	23,98
	0,45	9,23	11,45	2,95	26,78	18,13	119,38	21,56	27,40	25,03
	0,65	9,12	8,27	4,32	33,07	13,56	85,13	27,91	22,71	28,59
	0,72	8,98	60,22	2,74	25,21	25,00	62,65	26,42	11,00	32,61
0,5	0,25	3,13	31,68	2,04	20,18	15,46	102,59	26,47	32,59	23,44
	0,45	3,13	16,60	2,35	23,52	13,14	78,64	31,47	17,64	24,39
	0,65	3,13	11,22	3,01	26,48	12,55	48,58	35,17	10,83	25,72
	0,72	3,13	9,54	3,20	25,68	11,81	39,76	31,41	9,72	25,89
0,75	0,25	3,74	30,66	1,79	19,73	14,10	112,59	61,99	44,62	24,74
	0,45	3,74	17,45	2,23	20,43	13,61	90,31	57,62	18,63	22,68
	0,65	3,74	12,10	2,98	24,14	12,04	74,31	58,99	11,21	24,78
	0,72	3,74	11,67	3,19	24,86	10,89	66,20	59,38	8,48	23,44
1	0,25	2,50	26,97	2,16	22,53	17,86	109,67	112,73	32,01	22,48
	0,45	2,50	19,74	2,58	27,09	14,53	95,26	141,90	19,40	28,61
	0,65	2,50	17,45	2,75	30,00	15,90	71,11	326,98	15,67	31,04
	0,72	2,50	13,13	3,77	31,26	13,69	65,24	313,68	13,60	31,86

Tab, 1, Relative sensitivity of the state and control system variables to broken rotor fault based on experimental results in the sensorless control system,

ω [j.w.]	M_0 [j.w.]	x_{11} [%]	x_{12} [%]	x_{21} [%]	x_{22} [%]	i_m [%]	m_1 [%]	m_2 [%]	P_m [%]	Q_m [%]
0,25	0,25	5,25	74,03	4,73	35,23	37,16	148,69	35,68	71,06	42,73
	0,45	6,44	30,98	4,81	36,98	33,85	95,72	35,71	39,71	45,52
	0,65	7,03	25,61	4,16	31,04	32,23	63,18	45,82	43,29	64,92
0,5	0,25	2,50	81,93	3,31	25,63	32,99	166,05	37,76	104,03	34,66
	0,45	3,13	49,59	3,47	29,44	28,65	132,66	33,58	66,75	33,73
	0,65	2,50	31,17	3,70	32,51	27,27	120,04	40,19	44,32	31,05
	0,72	2,50	26,54	3,80	32,30	24,37	113,18	39,37	31,76	35,21
0,75	0,25	2,80	98,11	3,27	25,46	21,14	163,78	46,90	69,20	24,45
	0,45	2,80	63,15	2,90	25,17	27,53	147,71	59,73	80,86	29,59
	0,65	2,80	41,34	3,17	28,95	24,70	136,16	63,99	52,61	30,37
	0,72	3,74	37,42	2,91	30,36	23,44	123,57	62,55	35,60	29,32
1	0,25	2,50	80,06	2,22	19,95	23,17	163,55	179,55	85,92	25,45
	0,45	2,50	70,38	2,31	22,21	23,46	176,43	227,25	65,79	24,66
	0,65	2,50	46,87	2,67	24,80	25,04	137,35	120,92	45,07	26,53
	0,72	2,50	38,26	2,99	26,89	26,66	134,06	137,05	41,85	34,87

Tab. 2. Relative sensitivity of the state and control system variables to broken rotor fault based on experimental results in the closed-loop control system with speed measurement.

4. Conclusions

This paper is focused on experimental analysis of the state and control system variables sensitivity to rotor asymmetry diagnosis. Classical MCSA method has been investigated in variable speed IM drive, where advantages and disadvantages of this method were pointed. Next operation of the closed-loop drive operation with speed encoder was compared to sensorless operation with speed observer. Experimental results showed advantages of using sensorless control system comparing to using speed measurement encoders. Feasibility of compensation characteristic oscillations related to rotor asymmetry in the mechanical variables by tuning control system controllers parameters was presented. Cost of tuning controllers parameters for mechanical oscillations compensation is decreasing performance of the system in dynamical states. However it can be improved by proper filtering reference and internal control system variables. Finally sensitivity analysis of the state and control system variables to rotor asymmetry was presented for speed measurement based and sensorless control systems, where variables for early broken rotor detection were discriminated. For detection of the broken rotor fault in the earliest phase development using nonlinear decoupling control system variables m_1 , m_2 are recommended. From machine state variables especially reactive power is recommended for utilization for diagnostic purposes. Comparison of closed-loop and sensorless control system operation with asymmetrical machine indicated generally higher sensitivity of the first, while the latter provides wider stability range of operation due to speed observer filtering capability.

Equivalent scheme parameters of SG 132-S4 5.5 kW induction machine [p.u.]:

$$R_s = 0.04828, R_r = 0.04547, L_s = L_r = 2.05966, L_m = 1.97013.$$

Nominal machine parameters:

$$U_n = 400/230 \text{ [V]}, I_n = 10.9 \text{ [A]}, n_n = 1450 \text{ [rpm]}, p = 2.$$

References

- Cruz, M., Cardoso, A. J. (2007), "Fault Indicators for the Diagnosis of Rotor Faults in FOC Induction Motor Drives," *The IEEE International Electric Machines & Drives Conference*, Vol. 2, pp. 1136-1141.
- Kołodziejek, P., Bogalecka, E., (2009), "Broken rotor bar impact on sensorless control of induction machine" *Compel*, Vol. 28, No 3, pp. 540-555.

- Kołodziejek, P., Bogalecka, E., (2010), "*Broken rotor Symptoms in the Sensorless Control of Induction Machine*," International Conference & Exhibition on Ecologic Vehicles & Renewable Energies EVERMONACO 2010.
- Krzemiński, Z., (2001), "*Nonlinear Control of Asynchronous Machines*," Gdańsk 2001.
- Krzemiński, Z. (2006), "*Structure of speed observer with disturbance model for Induction Motor*," Modelling and Simulations '06, Kościelisko, pp.1-6.
- Rodriguez-Cortes, H., Hadjicostis, Ch.N., Stankovic, A. M. (2004), "*Model-Based Broken Rotor Bar Detection on an IFOC Driven Squirrel Cage Induction Motor*," *Proceeding of the 2004 American Control Conference*, Vol. 15, No. 2, pp. 3094-99.

About the authors

Piotr Kołodziejek has received at the Gdansk University of Technology M. Sc. Eng. title in Electrical Engineering in 2003, M. Sc. in Financial Management and Economics in 2006 and Ph. D. in electrical engineering in 2010. His research is related to modelling and experimental analysis of the physical phenomena including control systems of the electrical machines, diagnostic systems, renewable energy systems including wind and solar energy processing systems, distributed network-based control systems and financial market analysis. Piotr Kolodziejek is the corresponding author and can be contacted at: pkolod@ely.pg.gda.pl

