

Assembling and testing of quasi-static hybrid piezoelectric motor based on electroactive lubrication principle

JEAN-FRANCOIS ROUCHON¹, DOMINIQUE HARRIBEY¹, DUC-HOAN TRAN¹,
ROLAND RYNDZIONEK², ŁUKASZ SIENKIEWICZ², MIECZYSLAW RONKOWSKI²,
MICHAL MICHNA², GRZEGORZ KOSTRO²

¹ *Laboratoire Plasma et Conversion d'Énergie LAPLACE, Université de Toulouse
2, rue Camichel, 31071 Toulouse, France
e-mail: jean-francois.rouchon@laplace.univ-tlse.fr*

² *Faculty of Electrical and Control Engineering, Gdansk University of Technology
80-233 Gdańsk, ul. Narutowicza 11/12, Poland
e-mail: m.ronkowski@ely.pg.gda.pl*

(Received: 17.06.2012, revised: 16.01.2013)

Abstract: The presented paper concerns a novel concept of hybrid piezoelectric motor based on electroactive lubrication principle. Its structure is combined of quasi-static and resonance piezoelectric actuators, synchronizing their work to generate the rotary movement. The hybrid motor topology is compared to the existing piezoelectric motors, regarding its field of applications in embedded systems with very high security requirements. The electroactive lubrication principle is briefly presented with regards to optimization of the hybrid motor. The performance principle of the hybrid motor is described in terms of its working cycle. The assembling process of the prototype hybrid motor is briefly explained with emphasis put on the frequency and impedance tuning of the applied quasi-static and resonance piezoelectric actuators. Next, the hybrid motor power supply system is described and chosen measured performance characteristics are presented. Finally, conclusions concerning the features of the tested prototype hybrid motor and possible solutions of the faced issues, during assembling and testing, are presented.

Key words: piezoelectricity, piezoelectric hybrid motor, piezoelectric actuators, ultrasonic motors, quasi-static operation, resonance operation, electroactive lubrication, friction force control

1. Introduction

Several types of piezoelectric motors have been developed in few last decades. Due to the properties of piezomaterials, actuators with a lot of engineering advantages can be developed. They are compact, lightweight and solid state with large driving force, broad operating fre-

quency range, high stability, displacement proportional to applied voltage, 50% efficiency of energy conversion, rapid response, high precision down to nanometers and nonmagnetic field.

Generally, they are used in noise and vibration suppression systems, valves, laser and optics, positioning devices, relays, pumps, in automotive industry, industrial automation systems [1, 2, 4, 8, 10, 15].

Therefore, piezoelectric material would appear to be an attractive option for biomedical applications. Piezoelectric unimorphs and bimorphs have been used for a variety of sensor applications, such as pressure, impact, acceleration and vibration measurements and actuators. Piezoelectric polymers such as polyvinylidene fluoride have high flexibility. However, they have low electromechanical coupling coefficients compared to piezoelectric ceramics [16].

Present progress in the field of electroactive materials (piezoelectric, electrostrictive ceramics, magnetostrictive alloys, shape memory alloys) support a very promising innovations in the field of electromechanical energy conversion systems. The systems are characterized by a high functional integration level and high performance. It should be stressed that this depends essentially on the possibility of generating high specific efforts in a very reduced volume of mass, i.e., driving constraints are up to the order of 40 MPa in the PZT piezoelectric ceramics, or to the order of 100 MPa in the shape memory alloys. Amplitudes of the elementary displacements of actuators are limited, but cumulating these displacements in space, or in time (thanks to the transmission of a high frequency vibratory movement) rises the performance in terms of specific power. As presented in Figure 1, the comparison of performances of various electromechanical effects clearly shows the potential of novel electroactive materials. [1-5, 7-10].

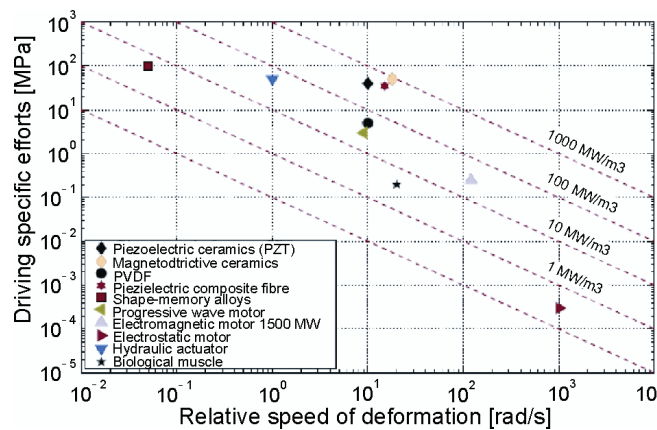

Fig. 1. Comparison of the various electromechanical effects in terms of specific energy [3]

The presented paper concerns a novel concept of hybrid piezoelectric motor based on an electroactive lubrication principle that is dedicated to the embedded system applications with very high security requirements. The assembling process of the motor is briefly explained with emphasis put on the frequency and impedance tuning of the applied quasi-static and resonance piezoelectric structures (actuators). The power supply system of the motor is described and

chosen measured performance characteristics are presented. Finally, conclusions concerning the features of the tested motor and possible solutions of the faced issues are presented.

2. Basic piezoelectric motors topologies

Generally, piezoelectric phenomena can be divided into two effects: generation of electric charge when subjected to mechanical stress (direct piezoelectric effect) and production of strain when the voltage is applied (inverse effect) to the piezoelectric material. Since its discovery, in the late XIX century, the piezoelectric materials have found a lot of applications. Nowadays, the PZT ceramics (lead zirconate titanate) are used in a variety of technology fields. Piezoelectric structures are especially desired in sensors, motors, actuators (e.g. nano-positioning stages in medical robotics), and particularly in the embedded systems with very high security requirements [1].

Referring to Figure 1, it can be proved that piezoelectric motors and actuators based on the electroactive materials have very good electromechanical properties (high torque, mass ratio, low relative speed) in the context of the application specifications. Presently available multi-layer piezoelectric ceramics exhibit a relative deformation of the order of 1000 parts per million, while the developed efforts may exceed 10 MPa when a contact interaction is used.

Modern piezoelectric motors are generally built using either quasi-static or resonance operating topologies. When they work in a step by step mode those structures rarely generate rated torque greater than tens of Nm. However, they exhibit interesting properties in terms of torque per mass ratio and relatively small dimensions compared to electromagnetic motors (Fig. 1).

As it has been mentioned above, the piezoelectric motors/actuators (examples shown in Fig. 2 and Fig. 3) can be divided into two main categories.

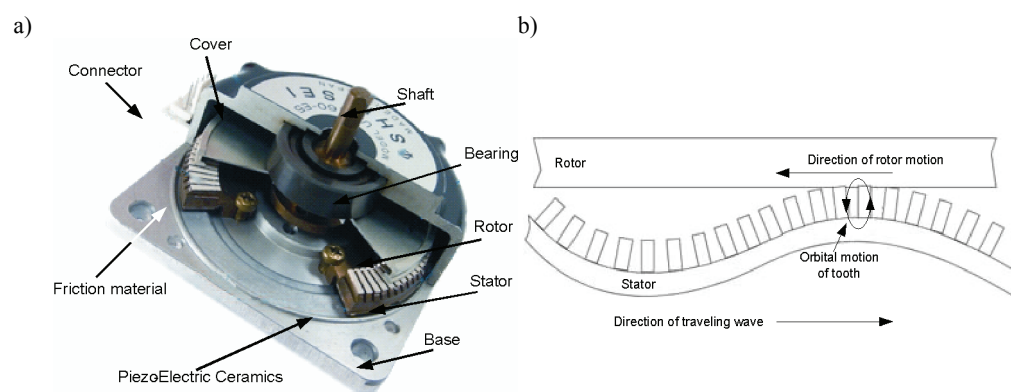

Fig. 2. Traveling-wave piezoelectric motor based on resonance structure:
 a) Shinsei type motor [17], b) traveling wave generation principle

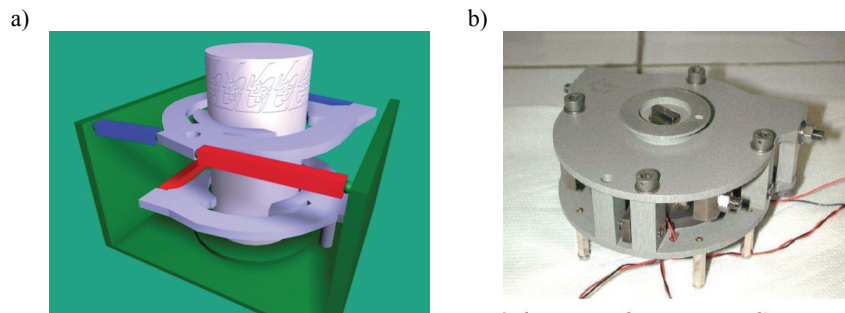

Fig. 3. Quasi-static operating piezoelectric actuator [13]: a) conception, b) prototype

A) Resonance structures

The small deformations (a few μm) produced by the piezoelectric ceramics are amplified by the resonance of the mechanical structure. The rotor is driven by friction. Kinematics used at the level of interface between the rotor and the stator impose the dynamic friction coefficient. The generated coefficient of friction is thus the dynamic friction coefficient. Produced forces are a priori weaker. The points at the rotor/stator contact surface are oscillating in an elliptic way. The tangential velocity generated on the stator surface of these motors ($\approx 0.5 \text{ ms}^{-1}$) is considerably greater than that of quasi-static structures and their operating area is located in the ultrasonic frequencies, which results in a silent operating. Nevertheless, they are less accurate than the quasi-static motors. Even during step by step operation, the rated torque of the piezoelectric motor rarely exceeds dozen Nm. These motors have attractive characteristics for the dedicated application in terms of torque developed per mass, but also in terms of size (decimeter scale) [8-10].

B) Quasi-static structures

Their operating principle is based on the deformation of ceramics, such as multilayer ceramics, of the order of a few microns, which are supplied with the low frequencies (below few hundreds of Hz). The multiplication of these micro displacements results in movements of larger amplitudes. This type of motors is used primarily for their nano displacement, precision and substantial generated forces. Moreover, the used kinematics is a solid and low speed ($\approx 3 \div 10 \text{ mms}^{-1}$). Thus, the contact imposes the coefficient of a static friction [2, 12].

For the dedicated applications the quasi-static structures have been chosen to implement modification of the operating principle to overcome recurring problems of conventional structures (sensitivity to wear, poor accommodation surfaces). The electroactive lubrication between rotor and stator is also added (using the resonance piezoactuators), in order to disengage rotor and stator in the return phase.

A combination of these two topologies, i.e., using hybrid topology, can result in further advantages in piezoelectric motors [5, 7]. The considered hybrid piezoelectric motor is characterized by much more compact dimensions and lower weight. It exhibits higher torque per volume ratio as well as good blocking ability when not powered. It operates at a low speeds and do not require any gear reduction system which leads to further gains in weight and

volume. Finally, it can work in higher temperatures compared to the variable reluctance motor. On the other hand, while using the piezoelectric elements there is a risk of depolarization as well as a shorter life span.

3. Electroactive lubrication principle

The structure of the considered piezoelectric motor was developed using the electroactive lubrication principle. The main idea is to control the friction forces between the rotor and stator [5]. By the vibrations (μm amplitude, a few kHz frequency) injected at the dry contact between two pieces, subjected to a certain relative speed, the frictional forces resulting from the movement between the two solid bodies are decreased. To increase motor efficiency, it is necessary to reduce the friction losses as low as possible. While keeping power consumption as low as possible it is possible to obtain a relatively high speed and vibration parameters (amplitude and frequency).

The principle of electroactive lubrication is based on the control of the friction forces. To obtain this goal, the injection of vibrations into the contact surface between rotor and stator is used. The friction control process can be divided in two main stages as shown in Figure 4:

- Contact surfaces are separated if the proper vibration magnitude is injected. For this state (indicated by interval t_1) there is no friction (friction force $F_{fr} = 0$).
- Upon contact of the surfaces, the two bodies have to be in the state of partial slip. While there is a full slip, the entire contact surface slides (the state is indicated by interval t_2 and speed V_2). For a partial slip and the proper distribution of the pressure the central part of the body is fixed (part of the contact is indicated by a red line in Figure 4: interval t_2 and speed V_1), while the peripheries of the body are sliding (part of the contact indicated by a green line in Figure 4). Thus, for the partial slip the friction is involved in a smaller area than for the full slip. As a result, the friction forces are reduced when the slip is partial.

To ensure the control of the friction forces, the ball is subjected to a static normal force P and the normal force F_{vib} (due to injected vibration). Depending on the dynamically produced value of the normal force, the separation of the surfaces will be effective or not.

Respecting those constrains, explained above, it is possible to specify the requirements for control of the vibration and friction in the considered hybrid piezoelectric motor.

According to the Figure 5, there are two fundamental parameters of vibration excitation: amplitude and frequency. In order to determine the most efficient contact for electroactive lubrication, it is crucial to investigate the importance of those parameters. For the minimum amplitude, there is the separation of contact surfaces. However, friction forces increase for the cylinder/plane contact while they decrease for the studs/plane contact. In general, lower amplitude of vibrations leads to a smaller separation of the surfaces, which increases duration of the contact, and as a result the electroactive lubrication is less effective.

For a high excitation frequency, the apparent friction coefficient tends to decrease until a low value. For studs/plane contact, the friction forces decrease more quickly for a frequency range less important. The augmentation of the frequency of the vibrations leads to a shorter contact time and results in a more effective electroactive lubrication.

The above considerations have shown that studs/plane contact (discretization of the contact surfaces) combined with the proper control of the amplitude and vibration frequencies allows to obtain the best conditions for the electroactive lubrication.

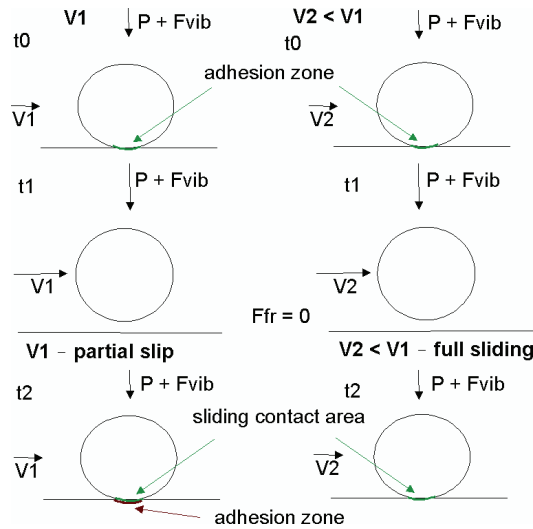

Fig. 4. Illustration of the electroactive lubrication principle applied in the hybrid piezoelectric motor: V_1, V_2 – velocities of the moving body, t_0 – full adhesion interval; t_1 – separation interval; t_2 – partial or full slip interval; P – static normal force; F_{vib} – normal force due to vibration; F_{fr} – friction force

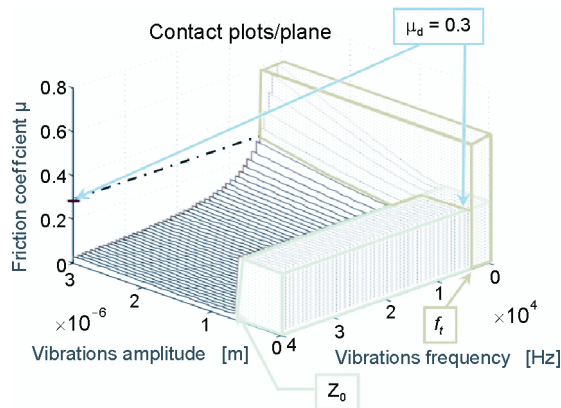

Fig. 5. Evolution of the friction coefficient as a function of the amplitude and frequency of vibrations for the discretized contact; Z_0 – minimal amplitude of vibrations; f_t – minimal frequency of vibrations; μ_d – selected dynamic friction coefficient

4. Hybrid piezoelectric motor working principle

The considered hybrid piezoelectric motor was developed for the embedded system applications. These applications imposes such motor parameters as: high torque/mass ratio, small overall dimensions and light weight. Moreover, the blocking torque when the motor is not powered is also required [13].

The hybrid piezoelectric motor has a basic structure composed of grippers containing resonance actuators and the exciters equipped with the multilayer ceramics as shown in Figure 6.

The hybrid nature of the motor is due to using two different types of piezoelectric actuators in order to generate a rotational movement. The driving force is generated by the exciters using the quasi-static actuators. They produce small deformations due to the operation of the high voltage multilayer ceramics. The basic step is then multiplied and drives the rotor.

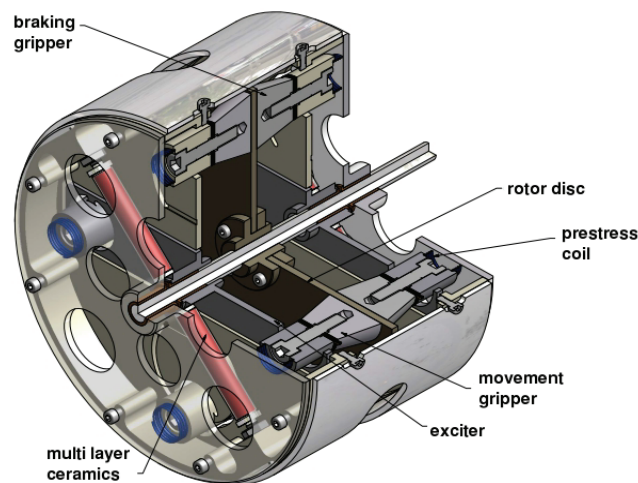

Fig. 6. Virtual structure (cut away view) of hybrid piezoelectric motor [6]

The purpose of the grippers is to lock and unlock the motor rotor at specific time intervals, and also to provide the electroactive lubrication. Due to using the resonance actuators, working in the bending mode, the vibrations are injected at the level of the rotor/stator interface. This leads to lowering the parasitic friction of the motor moving structures. It also supports the hybrid motor behavior to be independent of the evolution of ambient temperature, enables proper control of the motor performance [6]. The half of the hybrid motor consists of one exciter (using two multi layer ceramics) and two sets of grippers. The completed motor structure consists of those two halves and a rotor that is sandwiched between them.

The working cycle of the hybrid piezoelectric motor is shown in Figure 7.

One working cycle has the following operations:

- movement grippers hold the rotor when the exciter pieces move with the rotor;
- exciter pieces reach the high position level that the movement grippers can release the rotor;
- brake grippers lock the rotor and the exciter pieces return to the low position level;
- brake grippers unlock the rotor.

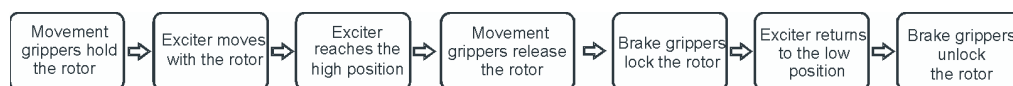

Fig. 7. Block diagram of the hybrid piezoelectric motor working cycle

To determine the natural frequencies corresponding to the bending mode of the gripper structure, the modal simulation has been carried out using the ANSYS software. As a result of this analysis it has been found that the resonance frequency has a value of 20.2 kHz, and the deformations are as shown in the Figure 8. This value has been compared with experimental results for the hybrid motor prototype.

```

1
NODAL SOLUTION
STEP=1
SUB =5
FREQ=20169
USUM (AVG)
RSYS=0

```

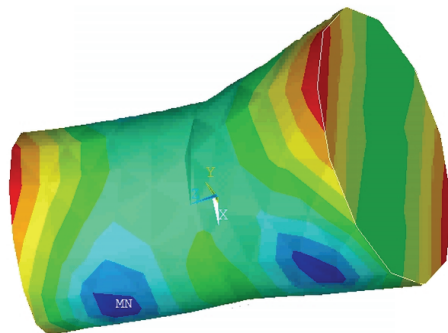

Fig. 8. ANSYS simulation results of the bending mode of the resonance actuator (gripper)

5. Assembling and tuning the prototype hybrid motor

The assembling and tuning of the prototype hybrid piezoelectric motor have been done in the following steps:

A) Preparation of the ceramics

The used PZT ceramics were sectorized using laser and then polarized in high electric field (2 Vmm^{-1}) and elevated temperature (95°C). Totally, 32 ceramic parts were prepared.

B) Assembling of the resonant actuators and frequency matching

The process has the following steps: arranging piezoceramics in a specific direction of polarization to maintain the bending deformations (Fig. 9); bolting the stack of PZT to the metal cylinders and adjusting the prestress force in order to set the proper working frequency. For this task an impedance analyzer was used. By detecting the minimum of the impedance plot the resonance frequency was obtained. As a result, the mechanical resonance of the grippers was set to 17.6 kHz and 18.6 kHz, respectively for the exciters.

The key aspect of the motor working principle was the proper synchronization between the actuators groups. In order to ensure the working cycle, both braking and movement grippers should have the same resonant frequency (chosen measured characteristics are shown in Figs. 10 and 11). The tuning process is focused on matching all the actuators to the same resonant frequency, as it is necessary for the motor to work properly. The best option is to set all eight actuators at the same level of frequency, but it has turned out that it was extremely difficult to set them (due to mechanical imperfections of the surface and poor available accuracy of the

frequency tuning). As it was described above, the characteristics of each part were regulated by adjusting the prestress force acting on the actuator. The best accuracy achieved was in the range of 50-100 Hz.

The assembling process of the completed motor structure has included the positioning of exciters and grippers in relation to the rotor disc as well as to the housing (the view of motor parts is presented in the Fig. 12).

Fig. 9. Orientation of the ceramics and the electrode

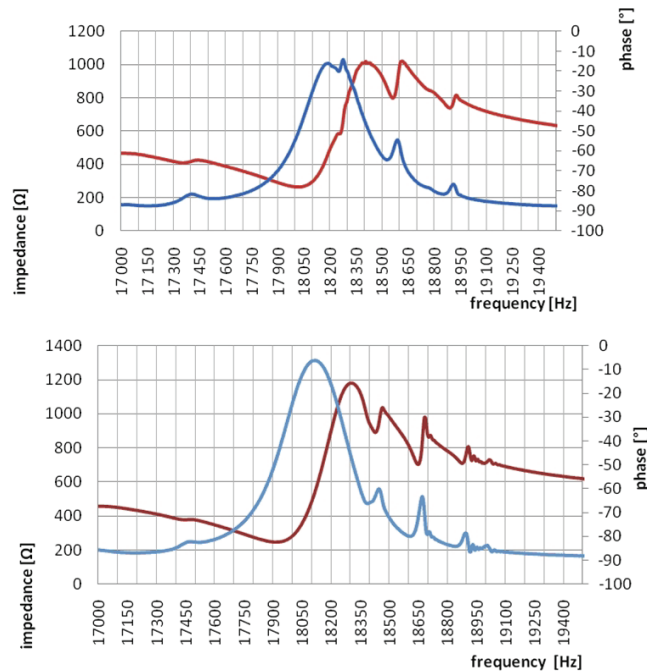
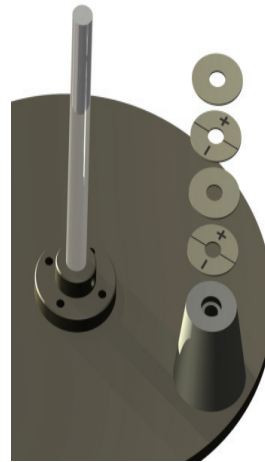

Fig. 10. Phase and impedance characteristics of one pair of the movement grippers (on each side of the rotor)

It was the crucial part of the whole process as the structure needed a very high level of precision to provide the best contact conditions for the electroactive lubrication principle. The motor characteristics were mainly tuned by minor changes in the position of the multilayer piezoceramics: their angle with respect to each other and the force with which they acted on the exciters. The key to the success was to place the multilayer ceramics in an optimal way. Depending on their position, different values of displacement were obtained.

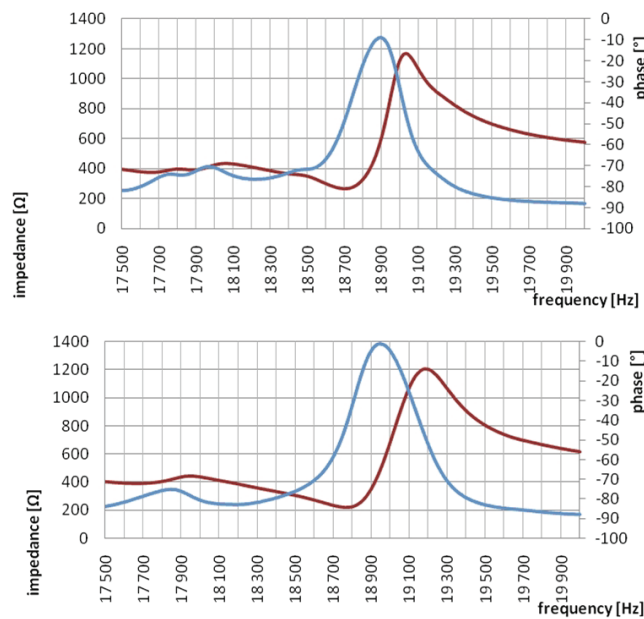

Fig. 11. Phase and impedance characteristics of one pair of the braking grippers (on each side of the rotor)

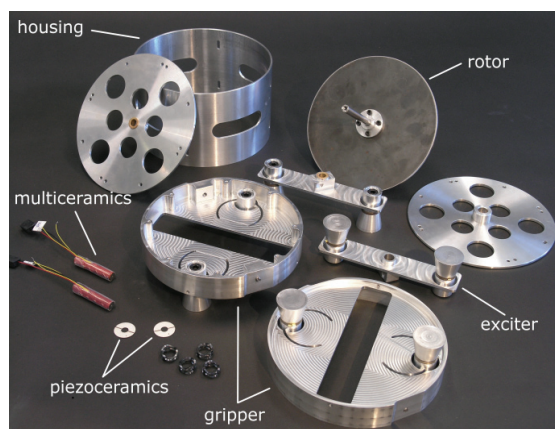

Fig. 12. Disassembled prototype hybrid piezoelectric motor [6]

The bolted force applied to the multi ceramics has affected the shape of the ceramics deformations, i.e., too strong tightening force has caused the trapezoidal deformations with a lot of distortions. The final setting of multilayer ceramics provided the displacement of 0.097 mm in one direction.

All measurements were carried out using the laser vibrometer to detect the speed of vibrations. Principally, its operation can be described as follows: laser sends a monochromatic light beam toward the target and collects the reflected radiation. According to the Doppler effect, the changed wavelength of the reflected radiation is a function of relative velocity of the targeted object. Thus, the velocity of the object can be obtained by measuring the change of the wavelength of the reflected laser light, which is done by forming an interference fringe pattern. The displacement of the actuator could be estimated using the vibrometer output value observed on the oscilloscope (Fig. 13). The value of the displacement A has been calculated as follows:

$$A = \frac{V \cdot Cal}{2\pi \cdot f} = \frac{11 \cdot 5}{2\pi \cdot 90} = 0.097, \quad (1)$$

where: A – displacement [mm], V – measured vibrometer's output voltage [V], Cal – vibrometer's calibration level [mm/s/V], f – multilayer ceramics working frequency [Hz].

Fig. 13. Measured vibrometer output voltage V versus time t representing the vibration velocity

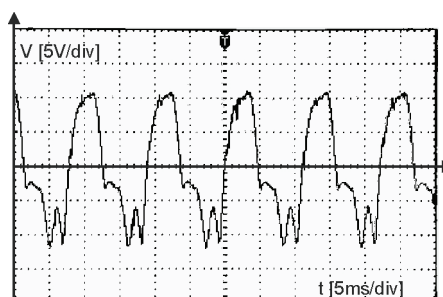

6. Testing the prototype motor

Requirements for the power supply of piezoelectric motors are much different compared to the electromagnetic motors. It is due to their much higher operating frequencies and the capacitive load character.

For testing the prototype hybrid piezoelectric motor a high frequency power supply system has been elaborated. The type DS1005 controller, a power converter, and type DS2004 high-speed A/D board were used. The DS1005 controller has processor board that provide the possibility for real-time monitoring and also functioning as an interface to the I/O boards and the host PC. The used power supply is based on the voltage fed, resonant, full-bridge topology. It has four inverters which can work in synchronization or independently and are supplied by a DC voltage source [13].

Application of Matlab and dSPACE have enabled the control of the power supplied of the prototype piezoelectric hybrid motor. By this way, the synchronization of the multilayer ceramic's supply with the duty cycle of the piezoceramic grippers was possible. The main program has four function blocks that are used to control the power switching process for each channel of the converter. According to the tested motor working cycle (Fig. 7), when exciters are working, the breaking grippers should not be fed by voltage, and vice versa. Additionally, the control of four frequencies of the movement and braking grippers was essential to maintain them in a resonance mode and to ensure the proper work of the motor. The voltage waveforms supplied to the motor are shown on the Figure 14. It represents the synchronization of the power supply between the multilayer ceramics and the grippers based on resonance actuators. For this mode of supply, the amplitude of supplying voltage for the piezoceramic grippers is about 200 V at the frequency of 17.6 kHz and 18.6 kHz and the excitation frequency of multilayer ceramics is about 90 Hz.

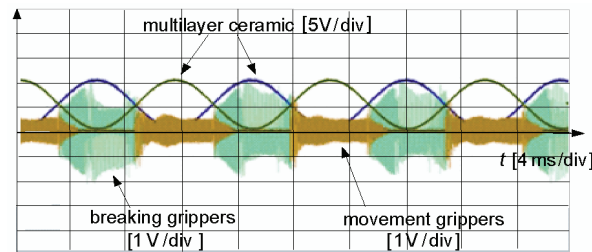

Fig. 14. Measured supply voltage waveforms of the multilayer ceramic and both grippers of the tested prototype hybrid piezoelectric motor for two modes of performance: braking/blocking, and rotation/movement at no-load

The tested prototype hybrid motor, having two sets of grippers, has generated the starting torque of 3.5 Nm, when rotor was braked/blocked (Fig. 15). By increasing the number of the grippers in the tested motor, it is possible to increase the developed torque.

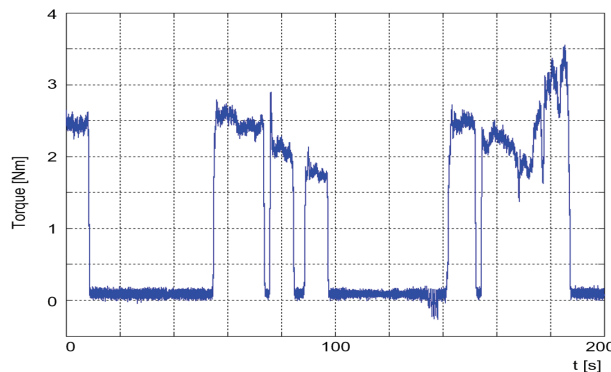

Fig. 15. Measured waveforms of starting torque for the tested prototype hybrid piezoelectric motor at the braking/blocking state

7. Conclusions

A novel concept of hybrid piezoelectric motor based on electroactive lubrication principle has been presented. Its current prototype has been built using the patented solution [6]. The hybrid motor structure is combined of quasi-static and resonance piezoelectric actuators, synchronizing their work to generate the rotary movement. Its topology has been compared to the existing piezoelectric motors, with regards to its field of applications in embedded systems with very high security requirements. The assembling process of the prototype motor has been briefly explained with emphasis put on the issues of frequency and impedance tuning of the applied quasi-static and resonance piezoelectric actuators. Chosen measured performance characteristics of the prototype hybrid motor have been presented. Using two sets of grippers, the motor starting torque has reached the value of 3.5 Nm. By increasing the number of the grippers in the tested motor, it is possible to increase the developed torque. Another advantage of this solution – the levels of security and redundancy are increased. These are very important features for the embedded system applications.

Further research works concerning the tested prototype hybrid piezoelectric motor have been planned.

References

- [1] Bishop R.H., *The Mechatronics Handbook*. The University of Texas, Austin (2002).
- [2] Nogared B., *Moteurs piezoelectriques*. Techniques de l'Ingenieur, D3765: 1-20 (1996).
- [3] Nogared B., Rouchon J-F, Renotte A., *Electroactive materials: towards novel actuation concepts*. Proc. Int. Conf. on Electrical Machines (ICEM), Poland, Cracow: 1-4 (2004).
- [4] Nogared B., Henaux C., Rouchon J-F., *Actionneurs électromécaniques pour la robotique et le positionnement*. Techniques de l'Ingenieur, D5341: 1-20 (2009).
- [5] Rouchon J-F., Cénac-Morthé C., Garbuio L., *Control of friction forces with stationary wave piezoelectric actuator*. Journal of Vibroengineering 10(2): 131-135 (2008).
- [6] Rouchon J-F, Jacob P., *Structure de moteur pas à pas de type chenille*. French Patent 2948244 (2011).
- [7] Salanson J., *Motorisations piézoélectriques à fonctionnement quasiréonnant ou quasistatique: analyse des contraintes d'alimentation et expérimentation de structures innovantes*. PhD thesis, INP-ENSEEIH-LEEI Toulouse (2000).
- [8] Sashida T., Kenjo T., *An introduction to ultrasonic motors*. Oxford, Clarendon Press (1993).
- [9] Hirata H., Ueha S., *Design of a travelling wave type ultrasonic motor*. IEEE Trans. of Ultrasonic, Ferroelectrics and Frequency Control 42: 225-231 (1995).
- [10] Dąbrowski M., *Evolution of the theory and application of ultrasonic motors*. Prace Instytutu Elektrotechniki 208 (2001).
- [11] Shuyu L., *Load characteristics of high power sandwich piezoelectric ultrasonic transducer*. Ultrasonics 43(5): 365-373 (2005).
- [12] Higuchi T., Yamagata Y., Furutani K., Kudoh K., *Precise Positioning Mechanism Utilizing Rapid Deformations Of Piezoelectric Elements*. Micro Electro Mechanical Systems, 1990. Proceedings, An Investigation of Micro Structures, Sensors, Actuators, Machines and Robots. IEEE (1990).
- [13] Szlabowicz W., *Contribution au dimensionnement et à la réalisation d'actionneur piézoélectrique à rotation de mode fort coupe pour applications aéronautiques*. PhD Thesis, INP-ENSEEIH-LEEI Toulouse (2006).

- [14] Tran D.H., Rouchon J-F., Nogarede B., *Design of a Power Inverter and Transformer for Piezoelectric Actuator*. IEEE International Workshop on Electronics, Control, Measurement and Signals (ECMS), Czech Republic, Liberec: 1-6 (2011).
- [15] Jeng S-L., Tung Y-C., *A Multicell Linear Power Amplifier for Driving Piezoelectric Loads*. IEEE Transactions On Industrial Electronics 55(10), (2008).
- [16] Ono Y., Liu Q., Kobayashi M., Jen C.-K., Blouin A., *A Piezoelectric Membrane Sensor for Biomedical Monitoring*. IEEE Ultrasonics Symposium (2006).
- [17] http://www.shinsei-motor.com/English/techno/ultrasonic_motor.html, accessed September 2012.