

A method of nonlinearities of transformer no-load characteristic modelling

Streszczenie. Przedstawiono sposób uwzględnienia zmian charakterystyki stanu jałowego przy modelowaniu transformatora. Przyjęto, że zmiany nasycenia rdzenia przedstawione są jako nieliniowa, zlepiana funkcja strumienia. Analizę osobliwości magnesowania rdzenia transformatora i symulację stanu jałowego wykonano na przykładzie transformatora rozdzielczego o mocy znamionowej 30 kVA i przekładni znamionowej 15.75/0.4 kV/kV, w szczególności przy zasilaniu bardzo niskim napięciem. Wyniki symulacji porównano z przebiegami zarejestrowanymi. (**Metoda modelowania nieliniowości charakterystyki stanu jałowego transformatora**).

Abstract. In the paper a way in which changes of the no-load characteristic are taken into account in the mathematical model of the transformer is presented. Changes of saturation within core of transformer are presented as a combined non-linear flux curve. Analysis of magnetization of the transformer core and simulation of no-load state for distribution transformer of 30 kVA power rating and 15.75/0.4 kV/kV (especially supplying VLV) transformation ratio rating were carried out.

Słowa kluczowe: Magnesowanie, nasycenie, modelowanie transformatora.

Keywords: Magnetization, saturation, transformer modelling.

Introduction

Measurement of a no-load characteristic can be carried out supplying a high voltage (HV) winding or a low voltage (LV) winding. The choice of the supplied winding follows from easiness of measurements, availability of measuring apparatus, and safety during tests, etc.

Presented measurements have been made as comparative and diagnostic tests. From that reason obtained values were measured with single-phase supply of the low voltage winding.

There are differences between values of no-load currents of each phase due to an unsymmetrical three-limb core used in distribution transformers. Next typical feature of a distribution transformer is inaccessibility of the neutral point if there is a star connection of high voltage winding.

Measurements of a no-load characteristic are usually made with changing of value of supply voltage in range $(0.5 \div 1.1)U_N$. The measurement results in range $(0.01 \div 1.1)U_N$ for transformer 380/220 V are presented in [1]. It was determined that there is non-linearity of the first part of the characteristic. In order to confirm that non-linearity, measurements with value of supply voltage below 10% U_N have been made as well. This part of the no-load characteristic for distribution transformer is shown in Fig.1a. Results obtained with value of supply voltage below 0.5 V were not taken into consideration due to low accuracy. Flux values have been calculated on the base of test results, when C phase-winding of the low voltage winding is energized, because of Yzn5 vector group of tested transformer.

On the base of transformer theory [2] and shape of a no-load characteristic (Fig. 1a) it can be determine that there is a non-sinusoidal current waveforms also with supplying transformer by small values of sinusoidal voltage. In order to confirm non-linearity of the characteristic with low values of flux, electromagnetic quantities waveforms have been recorded.

These nonlinearities can be taken into account in the mathematical model of the transformer in a few ways. Choice of appropriate method depends on type of researching phenomena. There can be used nonlinear function of resistance r_{Fe} and magnetization inductance [3]. Attempts of taking hysteresis into account are also taking up [4]. It is impossible to simulate phenomena caused by failures of parts of core, which cause local saturation of core by means of those methods.

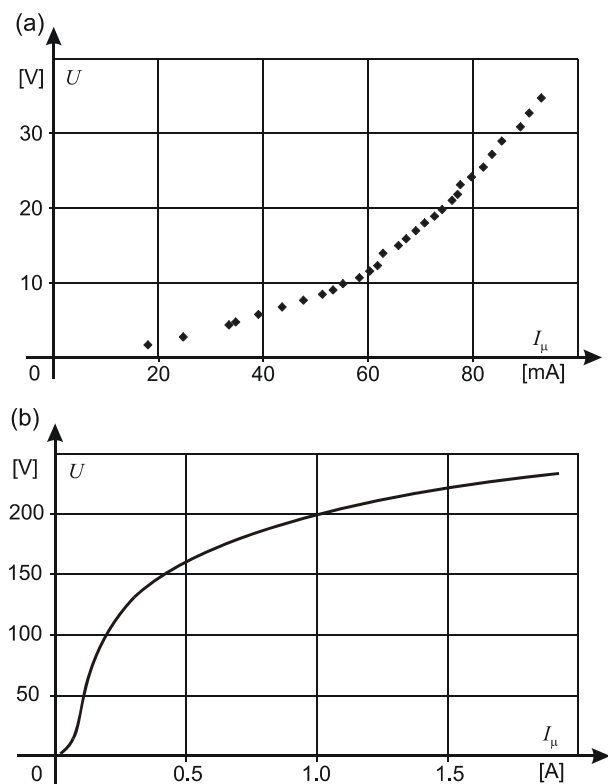

Fig. 1. A no-load characteristic of the distribution transformer (root-mean-square values). a) first part, b) full characteristic

No-load waveforms

Recording of voltage and current waveforms of steady no-load state enables analysis of a dynamic magnetization curve of a transformer with different values of supply voltage. Transient analysis presented in [1] has been used.

Instantaneous values of power and active power were calculated. This enabled to determine equivalent resistance of core loss r_{Fe} . Next step was determination of the active component of no-load current i_{Fe} . In order to get the magnetizing component of no-load current i_{μ} , the active component of no-load current was subtracted from no-load current i_0 . All components of no-load current are shown in the Fig. 2.

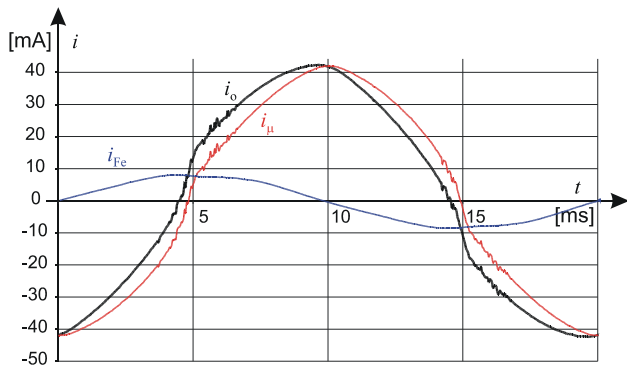

Fig. 2. No-load current waveforms with very low value of supply voltage

The flux ψ coupled with a winding can be calculated by integration of instantaneous voltage induced in a secondary winding. Calculations that enable to determine the dynamic magnetization curve with two values of supply voltage has been carried out (Fig. 3 and 4).

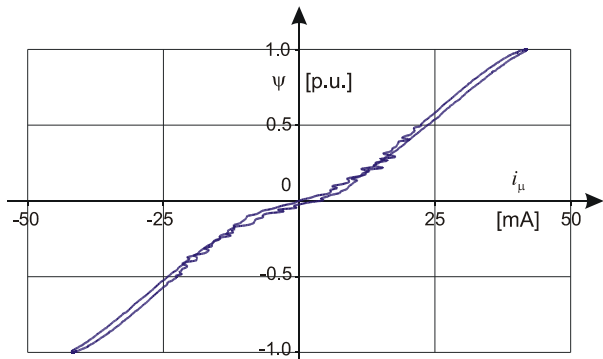

Fig. 3. Magnetization curve determined on the base of no-load waveforms of the transformer supplied by voltage $U = 0.0033 U_N$

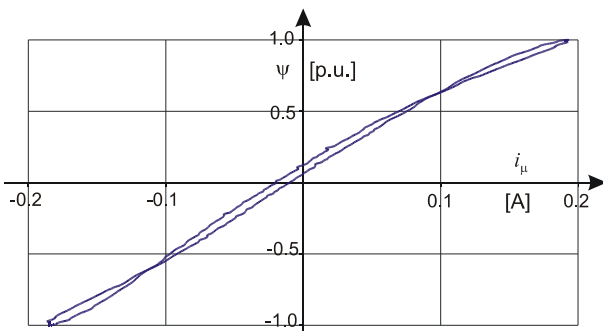

Fig. 4. Magnetization curve determined on the base of no-load waveforms of the transformer supplied by voltage $U = 0.135 U_N$

Model of transformer

The main electromagnetic parameters can be determined from design dimensions of a transformer core and using characteristic quantities calculated on the base of test results. Symbols of the transformer core's reluctances used for calculations of the transformer core's reluctances are shown in Fig. 5.

Reluctance with supply of a winding being on appropriate limb can be calculated from magnetizing inductance as function of magnetizing current, obtained on the base of test results. The same reluctance can be calculated using dimensions of transformer core:

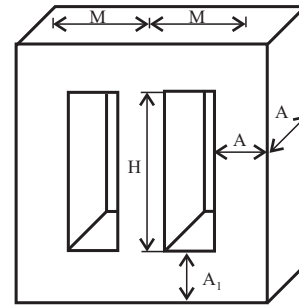

Fig. 5. Dimension symbols of the three-limb transformer core

$$(1) \quad R_m = \int \frac{dl_m}{\mu_o \mu_r S_m},$$

where: R_m – reluctance of a core section, l_m – length of a core section, S_m – cross-section area of a core section, μ_o – magnetic permeability of free space, μ_r – relative magnetic permeability of core

Relative magnetic permeability of core as function of coupled flux was determined by comparison of reluctances calculated in the ways described above. In Fig. 6a the first part of that characteristic for distribution transformer presented above is shown. There are shown results of calculations made on the base of measurements (solid red line) and their polynomial approximation (broken black line). The next part of the relative magnetic permeability curve is shown in Fig. 6b.

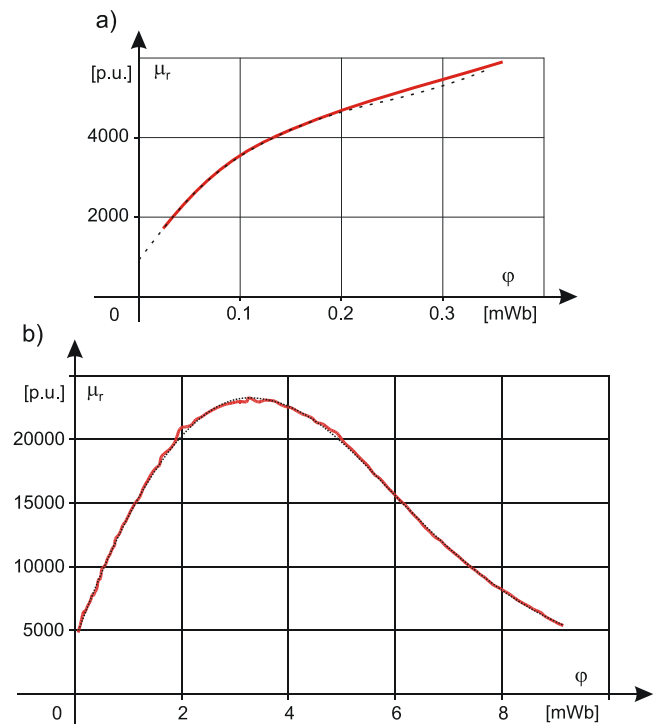

Fig. 6. Relative magnetic permeability as function of flux, calculated on the base of measurements and its polynomial approximation (broken line) 3rd order (a) and 5th order (b)

Ferromagnetic core of the transformer has been divided into several sections. Each of core elements is represented by non-linear reluctance, calculated as follows:
- for limbs (shown in the electromagnetic equivalent circuit as R_{cb}, R_{cb}, R_{cc}):

$$(2) \quad R_c = \frac{H + A_1}{\mu_o A^2} \cdot \frac{1}{\mu_r(\varphi)},$$

- for yokes (upper R_{pab} , R_{pbc} and lower R_{sab} , R_{sbc}):

$$(3) \quad R_p = R_s = \frac{M + A}{\mu_o A_1 A} \cdot \frac{1}{\mu_r(\varphi)},$$

where: A , A_1 , H , M are dimensions of the core (Fig. 5).

Function $\mu_r(\varphi)$ is calculated on the base of a polynomial that approximates the characteristic shown in Fig. 6.

Using statistic method [5] an approximation function of relative magnetic permeability has been assumed as following combined function:

$$(4) \quad \begin{aligned} \mu_r &= 169329\varphi^3 - 124628\varphi^2 + 36711\varphi + 949.3 \\ &\text{for } \varphi < 0.506115 \text{ [mWb]} \\ \mu_r &= -2.2057\varphi^5 + 54.07\varphi^4 - 330.06\varphi^3 - 1000.7\varphi^2 + \\ &\quad + 10955\varphi + 4309.6 \\ &\text{for } \varphi \geq 0.506115 \text{ [mWb]} \\ \mu_r &\Rightarrow 1 \\ &\text{for } \varphi \geq 10 \text{ [mWb]}. \end{aligned}$$

Equivalent resistances r_{Fe} represent losses of each of core segments, can be calculated using test results or design calculations. Using test results resistance r_{Fe} can be calculated as:

$$(5) \quad r_{Fe} = \frac{U^2}{\frac{1}{T} \int_0^T i_o u dt},$$

making allowance for vector group and three-limb transformer core.

Resistances of the HV windings (r_A , r_B , r_C) and segments of the LV windings (r_{a1} , r_{a2} , r_{b1} , r_{b2} , r_{c1} , r_{c2}) can be calculated at the design stage of the transformer or on the base of the short-circuit test results.

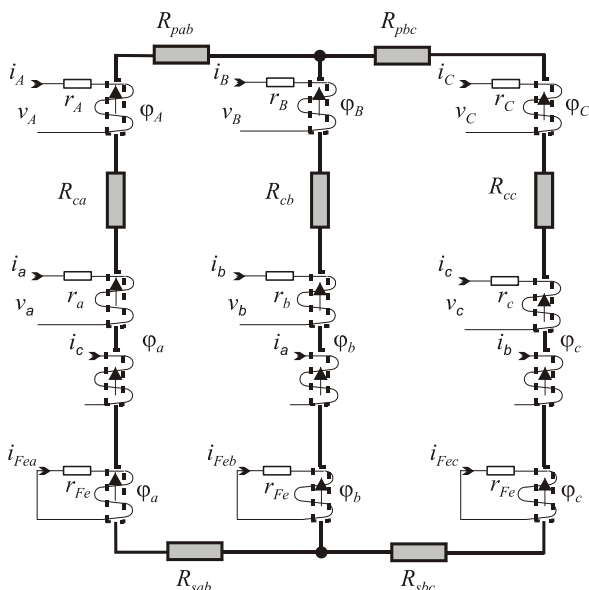

Fig. 7. Electromagnetic equivalent circuit for three-limb transformer with Yzn5 vector group

Simulations

Using method presented in [6, 7], the electromagnetic model of the transformer, in which equations relating

electrical and magnetic variables are solved simultaneously, has been developed. The zig-zag connection of the LV winding has been taken into account. It means that each phase-winding consists of two windings being on different limbs. In the electromagnetic equivalent circuit (Fig. 7) core loss has been taken into account as well. Circuits with equivalent resistance, that represents active losses of each of core elements, are coupled with flux in the limb. Saturation of core has been taken into account by the relative magnetic permeability as function of instantaneous values of flux. Reluctances which represent the leakage fluxes are omitted in presented circuit due to a no-load state of researching transformers. In this case, their influence on a shape and value of voltages is not significant. These reluctances are taken into account in the electromagnetic model presented in [8].

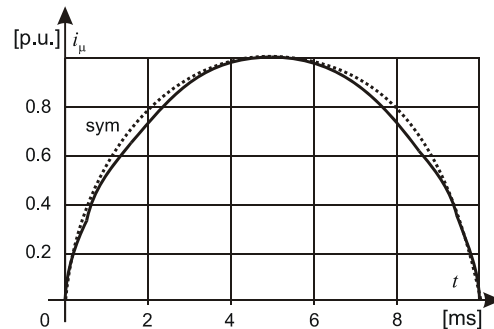

Fig. 8 Comparison of current waveform with low value of supply voltage obtained from simulation and current transient recorded during test

In order to investigate how non-linearity of the magnetizing characteristic affects shape of current with low value of voltage, simulations with voltages from range $(0.003 \div 0.01) U_N$ have been carried out. Simulations results were compared to the magnetizing component of no-load current, recorded during the no-load test. Examples waveforms are shown in Fig. 8. Supply voltage of 2C-phase of the LV winding was $0.0088 U_N$. Harmonics, higher than tenth, have been eliminated in current waveform.

Conclusions

Results of a particular no-load test with single-phase supply of the distribution transformer are presented. The purpose of this paper is to show that there can be non-linearity of a no-load characteristic other than comes from saturation of a magnetic material with significant values of magnetic field. Non-linearity of the no-load characteristic, both for dynamic tests and steady state tests, with low values of flux has been shown. There was shown also that in the dynamic characteristics with medium values of supply voltage, phenomenon of magnetic viscosity occurs. It causes additional active losses. That phenomenon is shown up in the dynamic characteristic as loops being at the edges of the magnetization curve.

Electromagnetic model of the transformer, used for simulations, enables to carry out researches of various phenomena in the device. It is possible to simulate, both steady states and transient states, of phenomenon with damaged of a chosen parts of a core (an example is shown in Fig. 9), failures of windings, etc. There is also possible to investigate influence of ferromagnetic being near to a part of winding or a core of transformer, if air reluctances are taken into consideration.

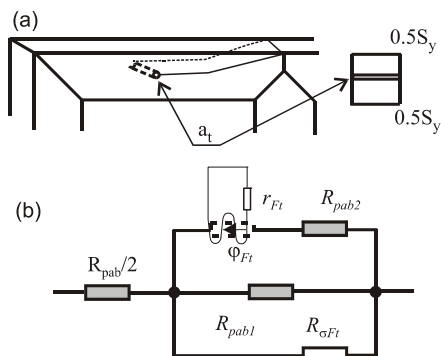

Fig 9. Sketch of failure (a) and equivalent circuit of a part of yoke (b) [8]. S_y – cross-section area of the transformer yoke, a_t – technological hole

Presented equivalent circuit can be used for detailed simulations of various changes of a transformer technical state. In this way, interpretation of the diagnostic measurements results obtained from a transformer with single-phase supply [9], is simplified.

Results of physical simulations of some transformer's faults in [10] where presented.

REFERENCES

[1] Matulewicz W., Baran S., Analysis of no-load transients in transformer diagnostic (in Polish), *Przeгляд elektrotechniczny*, R. LXXIX (2003), 5, pp. 339-342
 [2] Boedefeld Th., Sequenz H., *Elektrische Maschinen*, Wien, Springer-Verlag 1949

[3] Martinez J.A., Walling R., Mork B.A., Martin-Arnedo J., Durbak D., Parameter Determination for Modeling System Transients — Part III: Transformers, *IEEE Tran. on Power Delivery*, vol. 20 (2005), No. 3, July, pp. 2051-2062
 [4] Damnjanovic A., Parsley G.M.J., Modeling of Transformer Nonlinearities Taking Hysteresis into Account with Consuming Function and the Harmonic Balance Method, *IEEE AFRICON 2004*, pp. 741-744
 [5] Brandt S., *Data Analysis. Statistical and Computational Methods for Scientists and Engineers*, Springer-Verlag, New York 1999
 [6] Yacamini R., Bronzeado H., Transformer inrush calculations using a coupled electromagnetic model, *IEE Proc.-Sci. Meas. Technol.*, vol. 141 (1994), No. 6, November, pp. 491-498
 [7] Theocharis A.D., Tzinevrakis A., Charalampakos V., Miliadis-Argitis J., Zacharias Th., Transformer Modeling Based on Incremental Reluctances, *International Conference on Power System Technology 2010*, pp. 1-7
 [8] Matulewicz W., Baran S., Non-linear mathematical model of a three-phase transformer (in Polish), *Proceedings of XLI International Symposium on Electrical Machines*, 14 - 17 June 2005, Jarnołtów, Poland, pp. 333-337
 [9] Matulewicz W., Baran S., Diagnostic of the distribution transformers' core by single-phase supply (in Polish), *Przeгляд Elektrotechniczny*, R. 80 (2004), ISSN 0033-2097, Nr 10, pp. 936-939
 [10] Matulewicz W., Physical simulation of faults influence on voltage ratios in single phase supplied transformer (in Polish), *Przeгляд Elektrotechniczny*, R. 88 (2012), 7a, pp. 232-234

Autorzy: dr hab. inż. Wacław Matulewicz, Politechnika Gdańska, Wydz. Elektrotechniki i Automatyki, ul. Sobieskiego 7, 80-965 Gdańsk, E-mail: wamat@ely.pg.gda.pl, dr inż. Stefan Baran, DELLNER Sp. z o.o., ul. Chwaszczyńska 120, 81-571 Gdynia, E-mail: stefan.baran@dellner.com