

RAFAŁ HEIN *, *CEZARY ORLIKOWSKI* **

HYBRID REDUCED MODEL OF ROTOR

In the paper, the authors describe the method of reduction of a model of rotor system. The proposed approach makes it possible to obtain a low order model including e.g. non-proportional damping or the gyroscopic effect. This method is illustrated using an example of a rotor system. First, a model of the system is built without gyroscopic and damping effects by using the rigid finite element method. Next, this model is reduced. Finally, two identical, low order, reduced models in two perpendicular planes are coupled together by means of gyroscopic and damping interaction to form one model of the system. Thus a hybrid model is obtained. The advantage of the presented method is that the number of gyroscopic and damping interactions does not affect the model range.

1. Introduction

Modern engineering systems are constructed from a variety of components, some of which have pointwise concentrated features and others have spatially distributed ones. For these features to be properly reflected in the dynamic analyses models, these systems should be considered as partially lumped and partially distributed.

A particular example of a distributed or lumped-distributed system is a rotor. In general, such systems comprise a number of rigid disc elements mounted on a flexible, distributed shaft.

Distributed parameter systems are described by partial differential equations. In order to avoid mathematical difficulties arising from the manipulation on sets of mixed ordinary and partial differential equations, different approximate lumped models of distributed systems are usually applied. By using the finite element method, one can obtain an accurate model and final

* *Dr inż., Gdansk University of Technology, Poland; E-mail: rahe@pg.gda.pl*

** *Dr hab. inż., Gdansk University of Technology, Poland; E-mail: corlikow@pg.gda.pl*

results. However, obtaining a sufficiently accurate result requires a very fine mesh, and therefore a high-order model is needed.

For the analysis of response in large structural systems, the use of a high order model in its entirety requires considerable computer run time and large memory. Additionally, in many cases, a high order model is not very useful, e.g. in control systems analysis and design. Designers greatly benefit from the availability of very small models that represent the behaviour of a complex system with almost the same accuracy as a high order model. A simple but adequate model of a system reflects the basic properties and provides good insight into the process.

Model reduction can be done in many different ways. Two of the most common are:

- eigenvalue (modal) truncation [1,4],
- balanced model reduction [2].

The standard eigenvalue problem applies to linear undamped or proportionally damped systems with symmetric matrices. Unsymmetrical systems are difficult to handle in this procedure.

The balanced model reduction method is applied to linear, stable (with damping) systems. However, this approach is system input/output dependent. Systems with a large number of inputs and outputs are difficult to handle in this procedure, and the rank of model reduction is comparatively small.

This paper concerns the modelling of speed-varying rotor systems. The difficulties in modal analysis of rotor systems arise from the fact that here the equation of motion has an unsymmetrical matrix which describes gyroscopic phenomena [5]. To avoid the problem of a non-self-adjointed system, one can omit the gyroscopic phenomena and treat the rotor model as a simple beam model. In some cases, however, such models are not accurate enough. Moreover, these beam models can only reflect proportional damping.

The balanced model reduction method has none of the above limitations. However, neither of these methods can be applied in the case of speed-varying or nonlinear damped rotors. Instead, the following approach is proposed [7,8,9,10,11,12]. A modal-reduced model is created for a rotor without gyroscopic and damping effects. These are modelled separately using the rigid finite element method. The final reduced model is a hybrid one. It comprises two linear modal models of beams, one vibrating in the X-Z plane and the other in the X-Y plane, and spatially-lumped representations of the gyroscopic interaction between these two models. Non-proportional, nonlinear, internal and/or external lumped damping can be modelled in the same way.

Theoretically, it is possible to apply the balanced model reduction method to a rotor with or without gyroscopic and damping phenomena. In practice,



however, it is very difficult or even impossible to obtain a reduced model with a large number of inputs and outputs to connect with the rigid finite element model of gyroscopic and damping effects.

Fig. 1 presents the general concept of a hybrid reduced model of a speed-varying rotor with a damping and gyroscopic effect. Rigid finite element models of damping and gyroscopic interaction are algebraic equations, and they do not enlarge the order of the final reduced model.

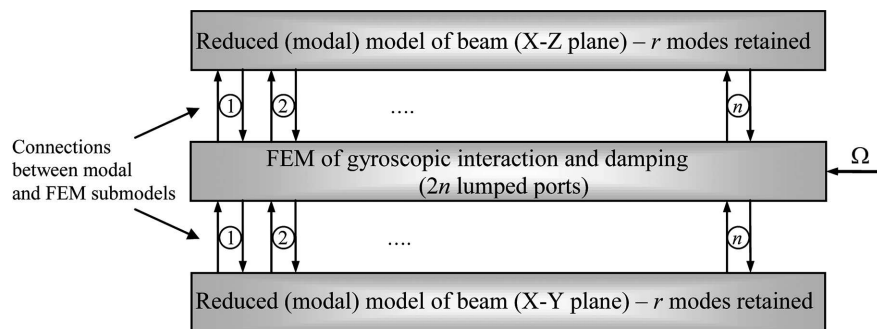

Fig. 1. General concept of reduced hybrid model of speed-varying rotor

2. Model of discontinuous speed-varying rotor

Let us consider a rotor system presented in Fig. 2. The model of the presented structure was built based on the Timoshenko beam model. It includes: rotary inertia, shear deformation, the gyroscopic effect as well as internal and external damping.

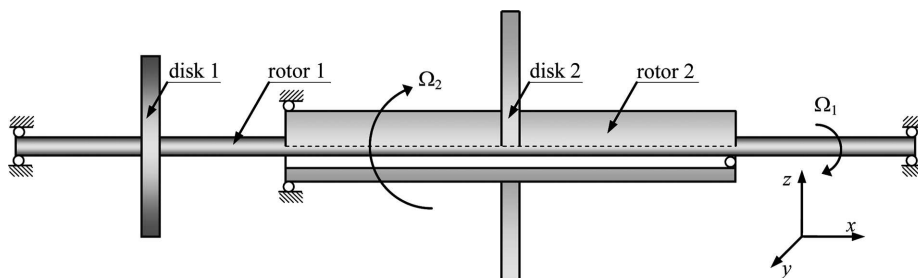

Fig. 2. General view of the considered rotor system

By applying the rigid finite element method [3,6], one can obtain the following equations for the rotor:

$$M\ddot{q}_y + B_y\dot{q}_y + G\dot{q}_z + K_yq_y = f_y, \quad (1)$$

$$M\ddot{q}_z + B_z\dot{q}_z - G\dot{q}_y + K_zq_z = f_z, \quad (2)$$

or

$$\begin{bmatrix} \mathbf{M} & 0 \\ 0 & \mathbf{M} \end{bmatrix} \begin{bmatrix} \ddot{\mathbf{q}}_y \\ \ddot{\mathbf{q}}_z \end{bmatrix} + \begin{bmatrix} \mathbf{B}_y & 0 \\ 0 & \mathbf{B}_z \end{bmatrix} \begin{bmatrix} \dot{\mathbf{q}}_y \\ \dot{\mathbf{q}}_z \end{bmatrix} + \begin{bmatrix} 0 & \mathbf{G} \\ -\mathbf{G} & 0 \end{bmatrix} \begin{bmatrix} \dot{\mathbf{q}}_y \\ \dot{\mathbf{q}}_z \end{bmatrix} + \begin{bmatrix} \mathbf{K}_y & 0 \\ 0 & \mathbf{K}_z \end{bmatrix} \begin{bmatrix} \mathbf{q}_y \\ \mathbf{q}_z \end{bmatrix} = \begin{bmatrix} \mathbf{f}_y \\ \mathbf{f}_z \end{bmatrix}, \quad (3)$$

where:

$\mathbf{q}_y, \mathbf{q}_z$ – vectors of generalized displacements along y and z axes (n – elements vector),

$\mathbf{f}_y, \mathbf{f}_z$ – vectors of generalized forces along y and z axes (n – elements vector),

$\mathbf{M}, \mathbf{B}, \mathbf{G}, \mathbf{K}$ – matrices of inertia, damping, gyroscopic and stiffness ($n \times n$ matrices).

The considered rotor system (Fig. 2) consists of two rotors rotating at angular speeds Ω_1 and Ω_2 . Taking into account the two subsystems, we can represent the vectors: $\mathbf{q}_y, \mathbf{q}_z$ as:

$$\mathbf{q}_y = \text{col}(\mathbf{q}_{y1}, \mathbf{q}_{y2}), \quad \mathbf{q}_z = \text{col}(\mathbf{q}_{z1}, \mathbf{q}_{z2}), \quad (4)$$

where subscripts 1 and 2 denote subsystems.

Equation (3) can be then presented in a more detailed form:

$$\begin{bmatrix} \mathbf{M}_{y1} & 0 & 0 & 0 \\ 0 & \mathbf{M}_{y2} & 0 & 0 \\ 0 & 0 & \mathbf{M}_{z1} & 0 \\ 0 & 0 & 0 & \mathbf{M}_{z2} \end{bmatrix} \begin{bmatrix} \ddot{\mathbf{q}}_{y1} \\ \ddot{\mathbf{q}}_{y2} \\ \ddot{\mathbf{q}}_{z1} \\ \ddot{\mathbf{q}}_{z2} \end{bmatrix} + \begin{bmatrix} \mathbf{B}_{y11} & \mathbf{B}_{y12} & 0 & 0 \\ \mathbf{B}_{y21} & \mathbf{B}_{y22} & 0 & 0 \\ 0 & 0 & \mathbf{B}_{z11} & \mathbf{B}_{z12} \\ 0 & 0 & \mathbf{B}_{z21} & \mathbf{B}_{z22} \end{bmatrix} \begin{bmatrix} \dot{\mathbf{q}}_{y1} \\ \dot{\mathbf{q}}_{y2} \\ \dot{\mathbf{q}}_{z1} \\ \dot{\mathbf{q}}_{z2} \end{bmatrix} + \begin{bmatrix} 0 & 0 & \mathbf{G}_1 & 0 \\ 0 & 0 & 0 & \mathbf{G}_2 \\ -\mathbf{G}_1 & 0 & 0 & 0 \\ 0 & -\mathbf{G}_2 & 0 & 0 \end{bmatrix} \begin{bmatrix} \dot{\mathbf{q}}_{y1} \\ \dot{\mathbf{q}}_{y2} \\ \dot{\mathbf{q}}_{z1} \\ \dot{\mathbf{q}}_{z2} \end{bmatrix} + \begin{bmatrix} \mathbf{K}_{y11} & \mathbf{K}_{y12} & 0 & 0 \\ \mathbf{K}_{y21} & \mathbf{K}_{y22} & 0 & 0 \\ 0 & 0 & \mathbf{K}_{z11} & \mathbf{K}_{z12} \\ 0 & 0 & \mathbf{K}_{z21} & \mathbf{K}_{z22} \end{bmatrix} \begin{bmatrix} \mathbf{q}_{y1} \\ \mathbf{q}_{y2} \\ \mathbf{q}_{z1} \\ \mathbf{q}_{z2} \end{bmatrix} = \begin{bmatrix} \mathbf{f}_{y1} \\ \mathbf{f}_{y2} \\ \mathbf{f}_{z1} \\ \mathbf{f}_{z2} \end{bmatrix}, \quad (5)$$

where:

$$\mathbf{M}_y = \begin{bmatrix} \mathbf{M}_{y1} & 0 \\ 0 & \mathbf{M}_{y2} \end{bmatrix}, \quad \mathbf{M}_z = \begin{bmatrix} \mathbf{M}_{z1} & 0 \\ 0 & \mathbf{M}_{z2} \end{bmatrix}, \quad \mathbf{B}_y = \begin{bmatrix} \mathbf{B}_{y11} & \mathbf{B}_{y12} \\ \mathbf{B}_{y21} & \mathbf{B}_{y22} \end{bmatrix},$$

$$\mathbf{B}_z = \begin{bmatrix} \mathbf{B}_{z11} & \mathbf{B}_{z12} \\ \mathbf{B}_{z21} & \mathbf{B}_{z22} \end{bmatrix}, \quad \mathbf{K}_y = \begin{bmatrix} \mathbf{K}_{y11} & \mathbf{K}_{y12} \\ \mathbf{K}_{y21} & \mathbf{K}_{y22} \end{bmatrix}, \quad \mathbf{K}_z = \begin{bmatrix} \mathbf{K}_{z11} & \mathbf{K}_{z12} \\ \mathbf{K}_{z21} & \mathbf{K}_{z22} \end{bmatrix},$$

$$\mathbf{G} = \begin{bmatrix} \mathbf{G}_1 & 0 \\ 0 & \mathbf{G}_2 \end{bmatrix}.$$

Matrices $\mathbf{G}_1, \mathbf{G}_2$ depend on Ω_1 and Ω_2 , respectively:

$$\mathbf{G}_1 = \Omega_1 \mathbf{G}_1^*, \quad \mathbf{G}_2 = \Omega_2 \mathbf{G}_2^*.$$

In general, f_y and f_z are functions of Ω_1 and Ω_2 (e.g. centrifugal forces)
 By substituting:

$$\mathbf{f}_{By} = \text{col}(\mathbf{f}_{By1}, \mathbf{f}_{By2}) = \mathbf{B}_y \dot{\mathbf{q}}_y, \quad \mathbf{f}_{Bz} = \text{col}(\mathbf{f}_{Bz1}, \mathbf{f}_{Bz2}) = \mathbf{B}_z \dot{\mathbf{q}}_z, \quad (6)$$

$$\mathbf{f}_{Gy} = \text{col}(\mathbf{f}_{Gy1}, \mathbf{f}_{Gy2}) = \mathbf{G} \dot{\mathbf{q}}_z, \quad \mathbf{f}_{Gz} = \text{col}(\mathbf{f}_{Gz1}, \mathbf{f}_{Gz2}) = -\mathbf{G} \dot{\mathbf{q}}_y$$

we can present equation (3) as

$$\begin{bmatrix} \mathbf{M} & 0 \\ 0 & \mathbf{M} \end{bmatrix} \begin{bmatrix} \ddot{\mathbf{q}}_y \\ \ddot{\mathbf{q}}_z \end{bmatrix} + \begin{bmatrix} \mathbf{K}_y & 0 \\ 0 & \mathbf{K}_z \end{bmatrix} \begin{bmatrix} \mathbf{q}_y \\ \mathbf{q}_z \end{bmatrix} = \begin{bmatrix} \mathbf{f}_y \\ \mathbf{f}_z \end{bmatrix} - \begin{bmatrix} \mathbf{f}_{By} \\ \mathbf{f}_{Bz} \end{bmatrix} - \begin{bmatrix} \mathbf{f}_{Gy} \\ \mathbf{f}_{Gz} \end{bmatrix} \quad (7)$$

or

$$\begin{bmatrix} \mathbf{M} & 0 \\ 0 & \mathbf{M} \end{bmatrix} \cdot \begin{bmatrix} \ddot{\mathbf{q}}_y \\ \ddot{\mathbf{q}}_z \end{bmatrix} + \begin{bmatrix} \mathbf{K}_y & 0 \\ 0 & \mathbf{K}_z \end{bmatrix} \cdot \begin{bmatrix} \mathbf{q}_y \\ \mathbf{q}_z \end{bmatrix} = \begin{bmatrix} \mathbf{f}_{\Sigma y} \\ \mathbf{f}_{\Sigma z} \end{bmatrix}, \quad (8)$$

where

$$\begin{bmatrix} \mathbf{f}_{\Sigma y} \\ \mathbf{f}_{\Sigma z} \end{bmatrix} = \begin{bmatrix} \mathbf{f}_y \\ \mathbf{f}_z \end{bmatrix} - \begin{bmatrix} \mathbf{f}_{By} \\ \mathbf{f}_{Bz} \end{bmatrix} - \begin{bmatrix} \mathbf{f}_{Gy} \\ \mathbf{f}_{Gz} \end{bmatrix}. \quad (9)$$

3. Modal decomposition

The model described by two equations derived from (7):

$$\mathbf{M} \ddot{\mathbf{q}}_y + \mathbf{K}_y \mathbf{q}_y = \mathbf{f}_{\Sigma y}, \quad (10)$$

$$\mathbf{M} \ddot{\mathbf{q}}_z + \mathbf{K}_z \mathbf{q}_z = \mathbf{f}_{\Sigma z}, \quad (11)$$

can be written in modal representation as:

$$\mathbf{M}_{my} \ddot{\mathbf{q}}_{my} + \mathbf{K}_{my} \mathbf{q}_{my} = \mathbf{f}_{my}, \quad (12)$$

$$\mathbf{M}_{mz} \ddot{\mathbf{q}}_{mz} + \mathbf{K}_{mz} \mathbf{q}_{mz} = \mathbf{f}_{mz}, \quad (13)$$

where:

$$\mathbf{M}_{my} = \Phi_y^T \mathbf{M} \Phi_y = \text{diag}(m_{y1}, \dots, m_{yr}, \dots, m_{yn}),$$

$$\mathbf{K}_{my} = \Phi_y^T \mathbf{K}_y \Phi_y = \text{diag}(k_{y1}, \dots, k_{yr}, \dots, k_{ym}),$$

$$\mathbf{M}_{mz} = \Phi_z^T \mathbf{M} \Phi_z = \text{diag}(m_{z1}, \dots, m_{zr}, \dots, m_{zn}),$$

$$\mathbf{K}_{mz} = \Phi_z^T \mathbf{K}_z \Phi_z = \text{diag}(k_{z1}, \dots, k_{zr}, \dots, k_{zn}),$$

$$\mathbf{q}_{my} = \text{col}(q_{my1} \ \cdots \ q_{myr} \ \cdots \ q_{myn}), \quad \mathbf{q}_{mz} = \text{col}(q_{mz1} \ \cdots \ q_{mzr} \ \cdots \ q_{mzn}),$$

$$\mathbf{f}_{my} = \Phi_y^T \mathbf{f}_{\Sigma y}, \quad \mathbf{f}_{mz} = \Phi_z^T \mathbf{f}_{\Sigma z},$$

$$\Phi_y = [\varphi_{y1} \quad \cdots \quad \varphi_{yr} \quad \cdots \quad \varphi_{yn}], \quad \Phi_z = [\varphi_{z1} \quad \cdots \quad \varphi_{zr} \quad \cdots \quad \varphi_{zn}],$$

in which:

m_{yi}, m_{zi} – modal coefficients of inertia respectively along the y and z axes,

k_{yi}, k_{zi} – modal coefficients of stiffness respectively along the y and z axes,

$\varphi_{yi}, \varphi_{zi}$ – eigenvectors of matrix $M^{-1}K$.

Then, by solving (12, 13) we can obtain the solution to (10, 11) in the form:

$$\mathbf{q}_y = \Phi_y \mathbf{q}_{my}, \quad \dot{\mathbf{q}}_y = \Phi_y \dot{\mathbf{q}}_{my}$$

$$\mathbf{q}_z = \Phi_z \mathbf{q}_{mz}, \quad \dot{\mathbf{q}}_z = \Phi_z \dot{\mathbf{q}}_{mz}.$$

4. Reduced hybrid model

Modal model (12, 13) can be reduced by removing the rows and columns in $M_{my}, K_{my}, M_{mz}, K_{mz}$ which are insignificant to the system's dynamics. Thus we obtain:

$$M_{myr} \ddot{\mathbf{q}}_{myr} + K_{myr} \mathbf{q}_{myr} = \mathbf{f}_{myr}, \quad (14)$$

$$M_{mzr} \ddot{\mathbf{q}}_{mzr} + K_{mzr} \mathbf{q}_{mzr} = \mathbf{f}_{mzr}, \quad (15)$$

where:

$$M_{myr} = \text{diag}(m_{y1}, \dots, m_{yr}), \quad M_{mzr} = \text{diag}(m_{z1}, \dots, m_{zr}),$$

$$K_{myr} = \text{diag}(k_{y1}, \dots, k_{yr}), \quad K_{mzr} = \text{diag}(k_{z1}, \dots, k_{zr}),$$

$$\mathbf{q}_{myr} = \text{col}(q_{my1}, \dots, q_{myr}), \quad \mathbf{q}_{mzr} = \text{col}(q_{mz1}, \dots, q_{mzr}),$$

$$\mathbf{f}_{myr} = \Phi_{yr}^T \mathbf{f}_{\Sigma y}, \quad \mathbf{f}_{mzr} = \Phi_{zr}^T \mathbf{f}_{\Sigma z}, \quad \Phi_{yr} = [\varphi_{y1} \quad \cdots \quad \varphi_{yr}].$$

By application of the reduced order model (14, 15) we can obtain an approximate solution to (10, 11) from the formulas:

$$\mathbf{q}_y = \Phi_{yr} \mathbf{q}_{myr}, \quad \dot{\mathbf{q}}_y = \Phi_{yr} \dot{\mathbf{q}}_{myr} \quad (16)$$

$$\mathbf{q}_z = \Phi_{zr} \mathbf{q}_{mzr}, \quad \dot{\mathbf{q}}_z = \Phi_{zr} \dot{\mathbf{q}}_{mzr}.$$

Taking into account Eq. (6), we can transform (14, 15) into the following form:

$$M_{myr} \ddot{\mathbf{q}}_{myr} + K_{myr} \mathbf{q}_{myr} = \Phi_{yr}^T \mathbf{f}_y - \Phi_{yr}^T \mathbf{B}_y \Phi_{yr} \dot{\mathbf{q}}_{myr} - \Phi_{yr}^T \mathbf{G} \Phi_{zr} \dot{\mathbf{q}}_{mzr}, \quad (17)$$

$$M_{mzr} \ddot{\mathbf{q}}_{mzr} + K_{mzr} \mathbf{q}_{mzr} = \Phi_{zr}^T \mathbf{f}_z - \Phi_{zr}^T \mathbf{B}_z \Phi_{zr} \dot{\mathbf{q}}_{mzr} + \Phi_{zr}^T \mathbf{G} \Phi_{yr} \dot{\mathbf{q}}_{myr} \quad (18)$$

or

$$\begin{bmatrix} \mathbf{M}_{myr} & 0 \\ 0 & \mathbf{M}_{mzr} \end{bmatrix} \begin{bmatrix} \ddot{\mathbf{q}}_{myr} \\ \ddot{\mathbf{q}}_{mzr} \end{bmatrix} + \begin{bmatrix} \mathbf{K}_{myr} & 0 \\ 0 & \mathbf{K}_{mzr} \end{bmatrix} \begin{bmatrix} \mathbf{q}_{myr} \\ \mathbf{q}_{mzr} \end{bmatrix} = \begin{bmatrix} \Phi_{yr}^T & 0 \\ 0 & \Phi_{zr}^T \end{bmatrix} \begin{bmatrix} \mathbf{f}_y \\ \mathbf{f}_z \end{bmatrix} - \begin{bmatrix} \Phi_{yr}^T \mathbf{B}_y \Phi_{yr} & 0 \\ 0 & \Phi_{zr}^T \mathbf{B}_z \Phi_{zr} \end{bmatrix} \begin{bmatrix} \dot{\mathbf{q}}_{myr} \\ \dot{\mathbf{q}}_{mzr} \end{bmatrix} - \begin{bmatrix} 0 & \Phi_{yr}^T \mathbf{G}_y \Phi_{zr} \\ -\Phi_{zr}^T \mathbf{G}_z \Phi_{yr} & 0 \end{bmatrix} \begin{bmatrix} \dot{\mathbf{q}}_{myr} \\ \dot{\mathbf{q}}_{mzr} \end{bmatrix}. \quad (19)$$

Equations (17, 18) and (16) or (19) and (16) present the final hybrid model, in which $\mathbf{f}_y, \mathbf{f}_z$ are the input data and $\mathbf{q}_y, \mathbf{q}_z$ result from the system described in (1, 2). A block diagram describing the above hybrid model is presented in Fig. 3. This shows that the hybrid model uses matrices $\mathbf{M}_{myr}, \mathbf{M}_{mzr}, \mathbf{K}_{myr}, \mathbf{K}_{mzr}$ from modal reduced models (14, 15) and matrices $\mathbf{B}_y, \mathbf{B}_z, \mathbf{G}$ from the initial FEM model (1).

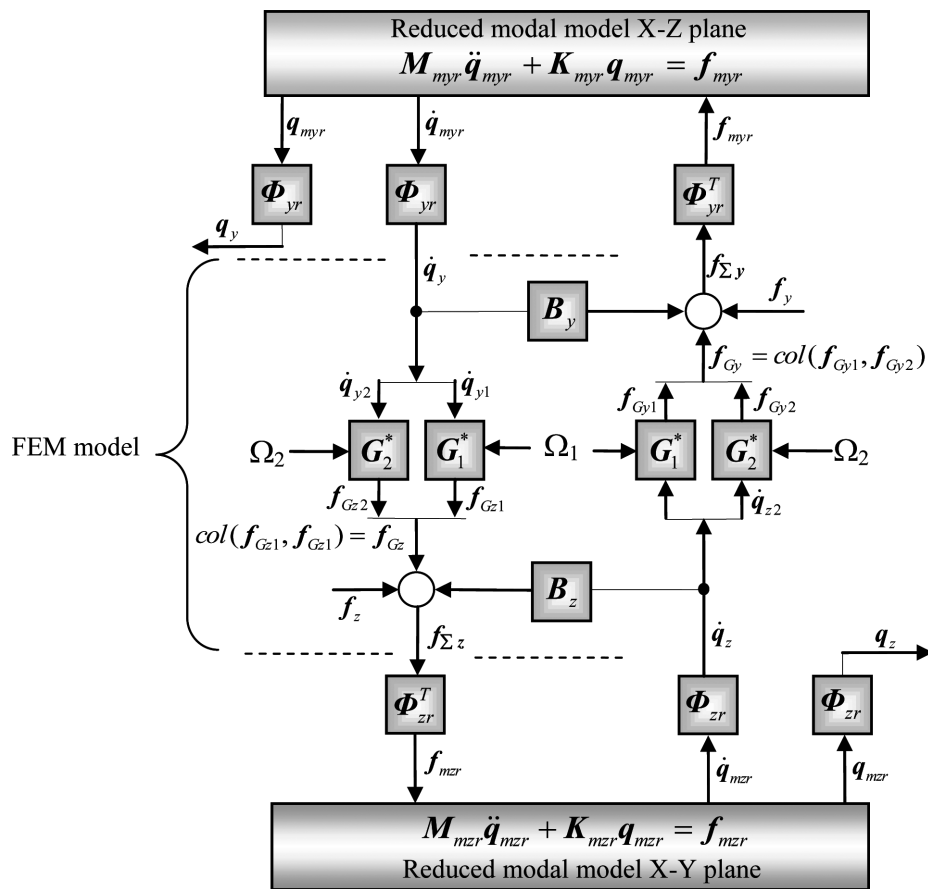

Fig. 3. Detailed block diagram of the hybrid model

5. Numerical calculations and results

As an example, let us consider the rotor system presented in Fig. 4, which has the following parameters: modulus of elasticity (Young's) $E = 2 \cdot 10^{11}$ [Pa], shear modulus (Kirchhoff's) $G = 7.8 \cdot 10^{10}$ [Pa], mass density $\rho = 8000$ [kg/m³]. A discrete model of the system (Fig. 5) is created using the rigid finite element method [3,6], where the continuous structure (Fig. 4) is divided into 152 rigid finite elements (RFE) as well as 156 spring-damping elements (SDE). Each RFE has four degrees of freedom, i.e. transverse displacements in y, z directions and angular displacements around x, y, z axes. FEM discretization is presented in Fig. 5.

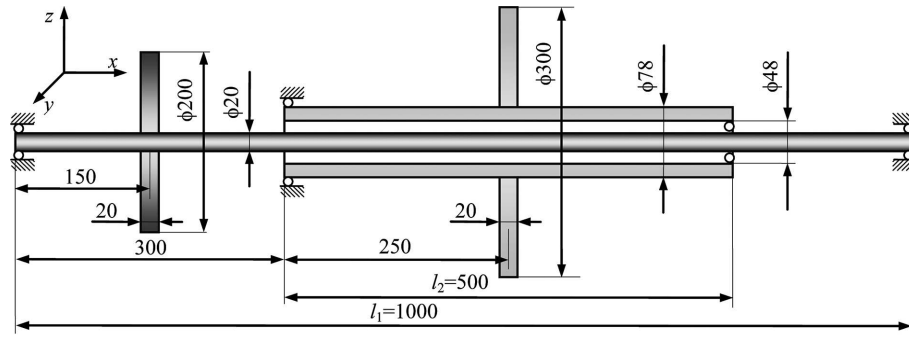

Fig. 4. The investigated rotor system

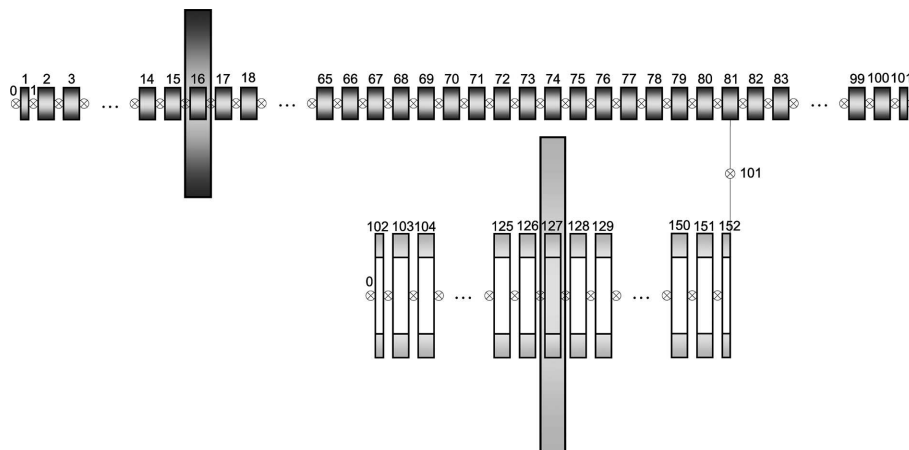

Fig. 5. The discrete model of the considered rotor system

The final model of the system also includes the gyroscopic effect. Fig. 6 presents the influence of the gyroscopic effect on the frequency characteristic, indicating that at the angular velocity $\Omega_1 = \Omega_2 = 1000$ [rad/s] it should be taken into account. The frequency response (Fig. 6) is prepared for the unit

Table 1.

The inertia coefficients of RFE no. r

r	m_r	$J_{y,r}$	$J_{z,r}$
	[kg]	[kgm ²]	[kgm ²]
1, 101	0.01256637061	$3.403392041 \cdot 10^{-7}$	$6.283185307 \cdot 10^{-7}$
2÷15, 17÷100	0.02513274122	$8.377580409 \cdot 10^{-7}$	$1.256637061 \cdot 10^{-6}$
16	5.02654824574	0.012733922222	0.025384068641
102, 152	0.11875220230	$6.250324248023 \cdot 10^{-5}$	$1.245116841 \cdot 10^{-4}$
103÷126, 128÷151	0.23750440461	$1.264908874892 \cdot 10^{-4}$	$2.490233682 \cdot 10^{-4}$
127	10.5451955647	0.063414412294894	0.1266530713303

Table 2.

The coefficients of SDE no. k and connection co-ordinates of SDE no. k to RFE no. r and p

r	p	k	$c_{k,x}$ [Nm ⁻¹] $b_{k,x}$ [Nsm ⁻¹]	$c_{k,y} = c_{k,z}$ [Nm ⁻¹] $b_{k,y} = b_{k,z}$ [Nsm ⁻¹]	$c_{k,xz}$ [Nm] $b_{k,xz}$ [Nsm]	$s_{r,k,x}$	$s_{r,k,z}$	$s_{p,k,x}$	$s_{r,k,z}$
1	2	1	6283185307.179 2617993.878	2067560665.144 861483.61	157079.633 65.45	0.0025	0	-0.005	0
⋮	⋮	⋮				0.005	0	-0.005	0
100	101	100				0.005	0	-0.0025	0
102	103	102	59376101152.847 24740042.147	19538448285.609 8141020.119	31127921.029 12969.967	0.0025	0	-0.005	0
⋮	⋮	⋮				0.005	0	-0.005	0
151	152	151				0.005	0	-0.0025	0
81	152	101	$2 \cdot 10^6$ 0	$2 \cdot 10^6$ 0	0 0	0.0025	0	0	0
0	1	0				0	0	-0.0025	0
101	0	0				0.0025	0	0	0
0	102	0				0	0	-0.0025	0

step input applied at the 16-th RFE (first disk) and the output displacement is observed at the same point.

A FEM model without gyroscopic and damping phenomena was constructed to obtain the modal model described by eq. (12, 13). Its first four eigenfunctions, taken into account in the reduced modal model, are shown in Fig. 7.

The reduced hybrid model (19) was built for 6 and 8 retained modes (3 and 4 eigenvalues for each plane of vibration).

To verify the reduced hybrid model obtained in that way, its frequency response was compared with that of the FEM model (reference model). The results are presented in Figs. 8 and 9. They were obtained for a force input acting at the 16-th RFE (first disk), with the output observed at the same point

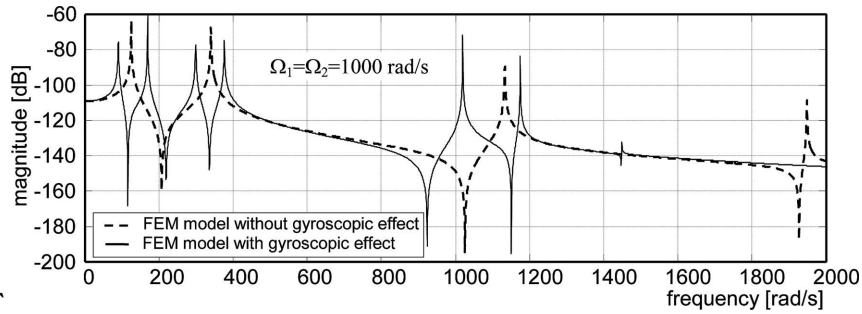

Fig. 6. Comparison of frequency characteristics of models

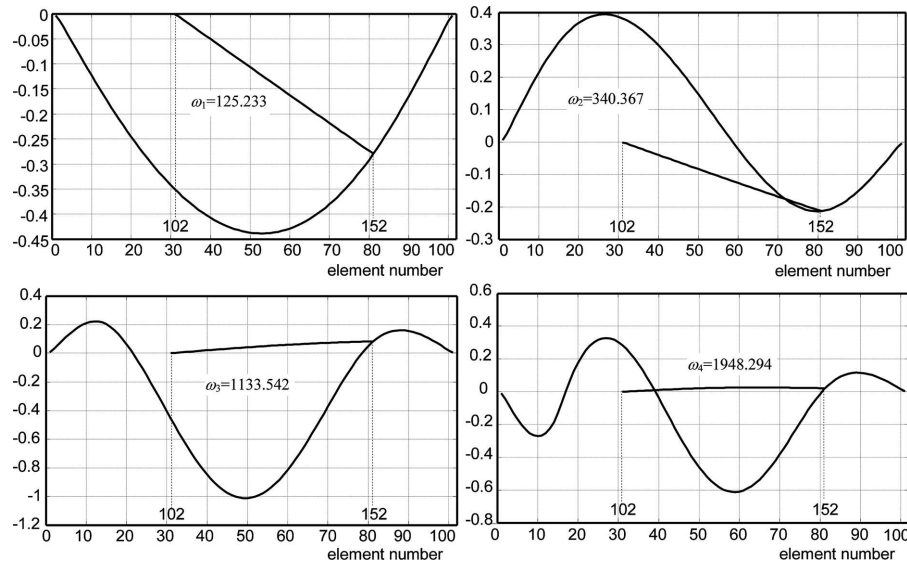

Fig. 7. Eigenvalues and eigenfunctions of the FEM model

(z-direction). All frequency characteristics were determined for the constant rotor speed $\Omega_1 = \Omega_2 = 1000$ [rad/s]. The model also takes into account damping for the cases shown in Fig. 9. Linear, non-proportional damping was considered. Numerical values of the applied damping coefficients are presented in Tab. 2.

Moreover, the models were compared and verified in the time domain. Simulations were performed for an unbalanced rotor with a pointwise mass $m = 0.001$ kg in the first disk (16-th RFE), and with an eccentricity $e = 0.003$. The rotors started with the varying speed $\Omega_1 = \Omega_2 = \Omega(t)$ and constant acceleration $\varepsilon_1 = \varepsilon_2 = 10$ rad/s². The output displacement was observed at the same point where the unbalanced pointwise mass was placed. Some of the obtained results are presented in Fig. 10. and 11. Additionally, it is worth

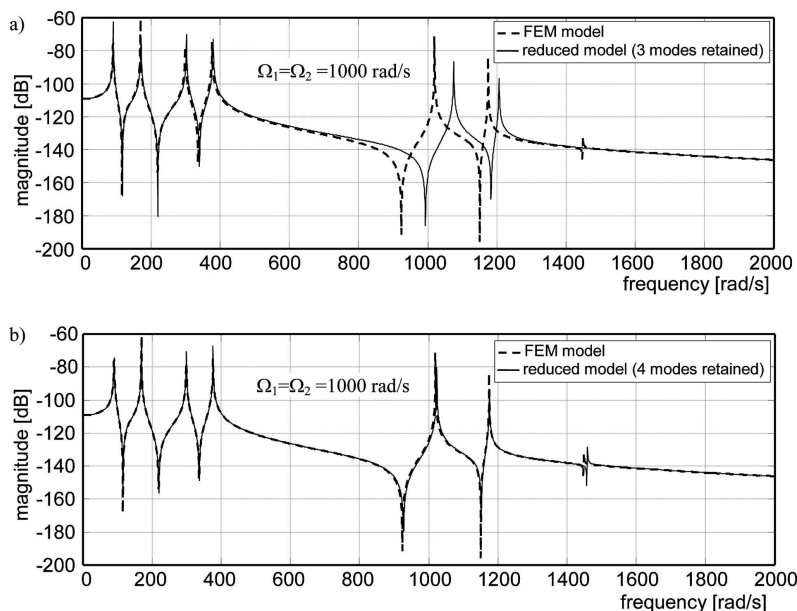

Fig. 8. Frequency characteristics of models with gyroscopic effect and without damping (a – 3 modes retained, b – 4 modes retained)

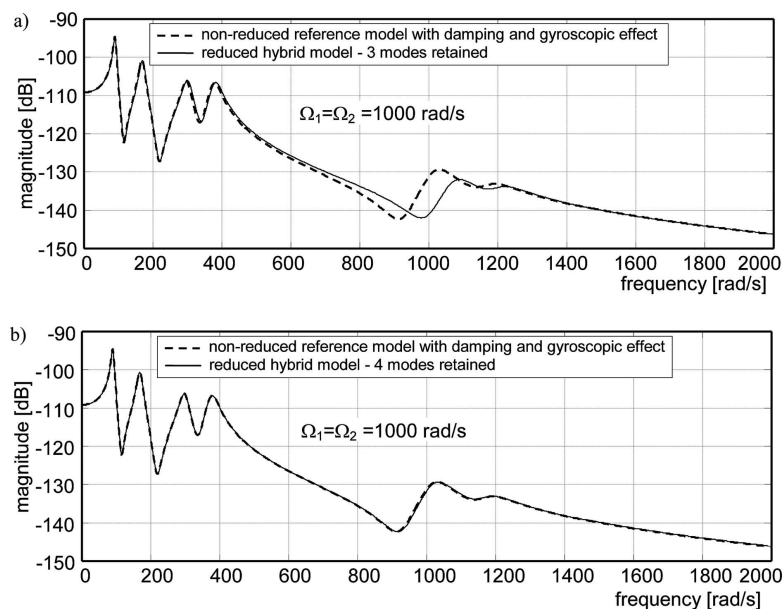

Fig. 9. Frequency characteristics of models with damping and gyroscopic effect (a – 3 modes retained, b – 4 modes retained)

to mention that the hybrid model simulation time is about 7 times shorter than the simulation time required for the full, reference model.

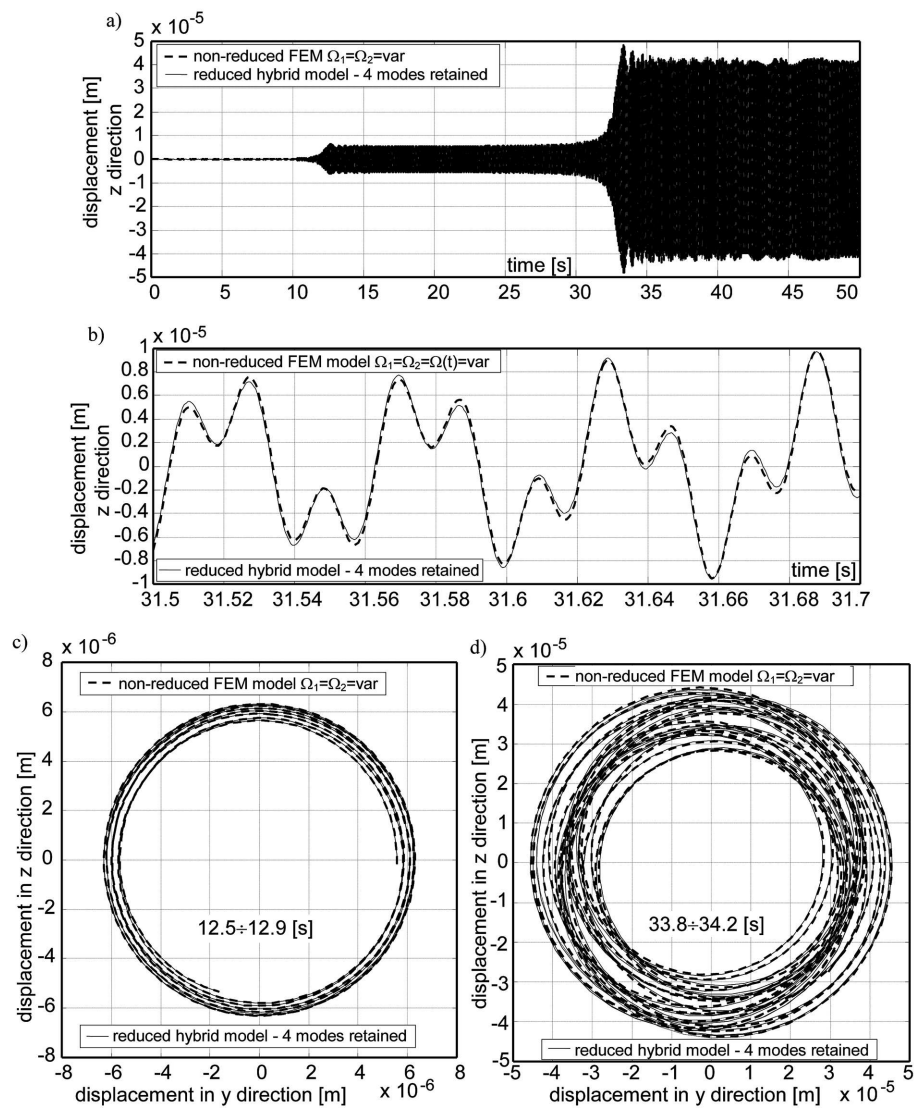

Fig. 10. Time response of the rotor with gyroscopic effect, without damping a) $t = 0 \div 50$, b) $t = 31.5 \div 31.7$ c) z-y displacement trajectory $t = 12.5 \div 12.9$, d) z-y displacement trajectory $t = 33.8 \div 34.2$

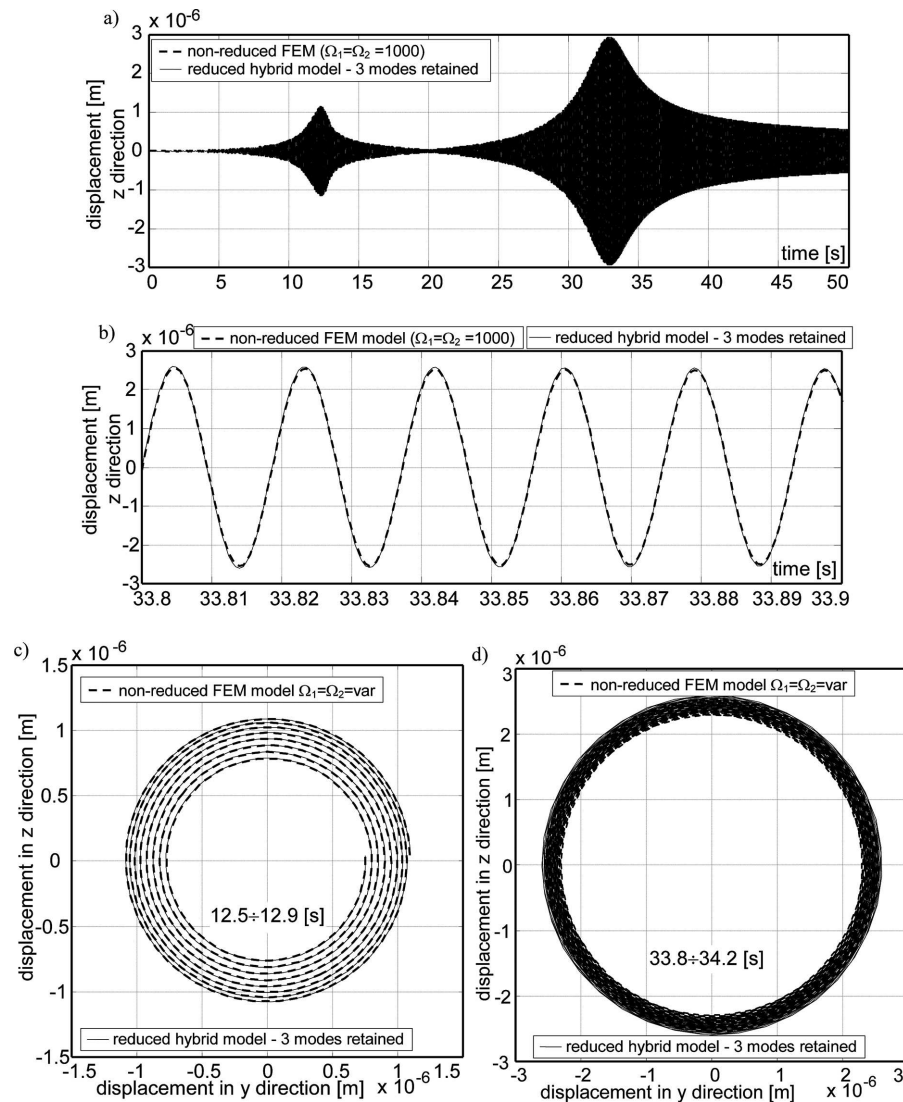

Fig. 11. Time responses of the rotor with gyroscopic effect and with damping ($\zeta = 0.05$ for all modes) a) $t = 0 \div 50$, b) $t = 33.8 \div 33.9$ c) z-y displacement trajectory $t = 12.5 \div 12.9$, d) z-y displacement trajectory $t = 33.8 \div 34.2$

6. Summary

In this paper, we presented reduction of a model of a gyroscopic and damped system using two techniques: modal decomposition and the rigid finite element approach. The final, reduced model consists of two parts: the reduced modal model and the rigid finite element model. The proposed

approach gives very good results for the frequency range with regard to the number of retained modes. Time plots have shown that the constructed hybrid model is also sufficiently accurate in the time domain. Hence, the proposed method of modelling is efficient and, due to the low order of the hybrid model, requires considerably less computer running time and memory.

Acknowledgements

The research is supported from the science budget resources in 2011-2014 as the research project (N N501 120240).

Manuscript received by Editorial Board, November 27, 2012;
final version, March 12, 2013.

REFERENCES

- [1] Friswell A. M. I.: Candidate reduced order models for structural parameter estimation. *ASME Journal of Vibration and Acoustics*, vol. 112(93) (1990).
- [2] Gawronski W.K.: *Dynamics and Control of Structures, A Modal Approach*, Springer, New York, 1998.
- [3] Gawroński W., Kruszewski J., Ostachowicz W., Tarnowski J., Wittbrodt E.: *The finite element method in the dynamics of structures [in Polish]*, Arkady, Warsaw 1984.
- [4] Hatch Michael R.: *Vibration Simulation Using MATLAB and ANSYS*, Chapman & Hall/CRC, 2001.
- [5] Krämer E.: *Dynamics of Rotors and Foundations*, Springer-Verlag, 1993.
- [6] Kruszewski J., Gawroński W., Wittbrodt E., Najbar F., Grabowski S.: *The rigid finite element method [in Polish]*, Arkady, Warsaw 1975.
- [7] Orlikowski C., Hein R.: Modal reduction and analysis of gyroscopic systems. *Solid State Phenomena* 164 (2010) 189-194.
- [8] Orlikowski C., Hein R.: Hybrid, approximate models of distributed-parameter systems. The 12th Mechatronics Forum Biennial International Conference. Part 2/2, Zurich, June 28-30, 2010 / H. Wild, K. Wegner. – Swiss Federal Institute of Technology (2010) 163-170.
- [9] Orlikowski C., Hein R.: Reduced model of gyroscopic system, *Selected Problems of Modal Analysis of Mechanical Systems*, Editor T. Uhl, Radom: Publishing House of the Institute for Sustainable Technologies National Research Institute, 2009, AGH, Kraków 2007.
- [10] Orlikowski C., Hein R.: Modelling and analysis of rotor with magnetic bearing system, *Developments in mechanical engineering*, Editor J. T. Cieśliński, GUTP, Gdansk 2008.
- [11] Orlikowski C., Hein R., Cyran R.: Computational algorithm for the analysis of mechatronic systems with distributed parameter elements, *Mechatronic design. Selected issues*, Joined publication, edited by T. Uhl, Cracow 2010, Scientific publisher ITE-PIB, 2010. – s. 115-122.
- [12] Orlikowski C., Hein R.: Modelling and analysis of beam/bar structure by application of bond graphs, *Journal of Theoretical and Applied Mechanics*, Vol. 49, No. 4 (2011), s. 1003-1017.

Hybrydowy zredukowany model wirnika**Streszczenie**

W pracy zaprezentowano metodę redukcji modelu wirnika z efektem żyroskopowym i tłumieniem. Do budowy modelu zredukowanego wykorzystano dwie metody konstruowania przybliżonych modeli dyskretnych układów ciągłych – metodę dekompozycji modalnej oraz metodę dyskretyzacji przestrzennej (elementów skończonych).

Zredukowany model modalny zbudowano dla tej części modelu, dla której łatwo jest formułować warunki ortogonalności. Pozostałe zjawiska, które powodują trudności w formułowaniu warunków ortogonalności np. efekt żyroskopowy lub nieproporcjonalne tłumienie, zamodelowano z wykorzystaniem metody elementów skończonych. Następnie powiązано ze sobą dwa takie same modele drgające w płaszczyznach wzajemnie prostopadłych poprzez zamodelowane oddziaływania żyroskopowe lub nieproporcjonalne tłumienie.

Zaprezentowana metoda umożliwia otrzymanie modelu wirnika niskiego rzędu przy zmiennej prędkości kątowej oraz z dowolnym rodzajem tłumienia wewnętrznego i zewnętrznego. Zaprezentowany przykład analizy wirnika potwierdza skuteczność zaproponowanego ujęcia.