

DIAGNOSTICS OF BOLTED LAP JOINT USING GUIDED WAVE PROPAGATION

Rafał KĘDRA, Magdalena RUCKA

Gdańsk University of Technology, Faculty of Civil and Environmental Engineering,
Department of Structural Mechanics and Bridge Structures,
ul. Narutowicza 11/12, 80-233 Gdańsk, Poland, tel. 58 347 24 97,
e-mail: rafkedra@gmail.com, mrucka@pg.gda.pl

Summary

The paper presents numerical and experimental analyses of elastic waves propagation in a bolted lap joint. In experimental investigations condition assessment of the joint was performed with the use of symmetric waves excited by a piezoactuator. Numerical calculations were conducted in commercial finite element method software Abaqus. The influence of number of bolts and the value of the initial stress on recorded signals was examined. The study showed the possibility of using elastic waves in the context of diagnostics of bolted joints.

Keywords: elastic waves, non-destructive testing, bolted lap joint, finite element method

DIAGNOSTYKA ZAKŁADKOWEGO POŁĄCZENIA ŚRUBOWEGO Z UŻYCIEM PROPAGACJI FAL PROWADZONYCH

Streszczenie

Praca przedstawia numeryczne i eksperymentalne analizy propagacji fal sprężystych w zakładkowym połączeniu śrubowym. W badaniach eksperymentalnych wykorzystano fale wzbudzone w płaszczyźnie połączenia za pomocą piezoaktuatora. Obliczenia numeryczne wykonano w środowisku komercyjnego programu metody elementów skończonych Abaqus. W badaniach analizowano wpływ liczby śrub i wartości momentu dokręcającego na zarejestrowane sygnały. Wykazano możliwość zastosowania fal sprężystych do diagnostyki połączeń.

Słowa kluczowe: fale sprężyste, diagnostyka nieniszcząca, połączenie śrubowe, metoda elementów skończonych

1. INTRODUCTION

Preloaded bolted joints belong to the group of non-deformable connections. They are widely used in civil and mechanical engineering due to ease of assembly, durability and high load capacity. The use of them in elements essential for the proper work of an entire structure causes the need to develop methods for diagnostics and monitoring of this type of connection. Recently, non-destructive methods based on the propagation of elastic waves have been often and willingly used for damage assessment because they are relatively inexpensive and they allow testing of inaccessible areas of structures.

Wave propagation-based diagnostic methods aimed at the monitoring of bolted joints can be divided into two groups. In the first one, a disturbance is used to define the stress state of a single bolt. The bolt effort can be identified based on the time of flight of the wave, the bolt resonant frequency or the acoustic attenuation and the phase velocity changes [1, 2, 3]. The disadvantage of this type of methods lies in need of an individual examination of each bolt, ensuring the repeatability and high accuracy of measurements. The second group includes methods using qualitative and

quantitative changes in measured wave propagation signals which allow to determine the condition of the entire connection. Amerini and Meo [4] developed three different tightening/loosening state indexes related to the first-order acoustic moment and the physical phenomenon of generation of the second harmonic and the sidebands in the spectrum of the high frequency signal. Another approach to diagnostics of bolted connections is application of high-frequency vibration tests [5]. This method involves the study of responses of damaged and undamaged structures subjected to variable frequency impulse. Examples of quantitative methods based on the continuous wavelet transform and the bilinear relationship between the bolt torque and the signal energy are presented in papers [6, 7]. A common feature of previously conducted research is the use of excitation and measurement signals of elastic waves in the direction perpendicular to the joint plane, resulting in inducing of antisymmetric modes. In this paper application of symmetric waves for diagnostics of steel bolted connection is presented. The study contains results of experimental and numerical investigations for different configurations of fasteners and different level of bolt torque.

2. EXPERIMENTAL INVESTIGATIONS

2.1. Model description

The research was conducted for a single lap bolted joint (Fig. 1). It was made of two steel sheets of dimensions $6 \text{ mm} \times 60 \text{ mm} \times 200 \text{ mm}$ and $6 \text{ mm} \times 200 \text{ mm} \times 200 \text{ mm}$. Four circular holes of 11 mm diameter were cut in both steel elements to assemble them with machine bolts of 10 mm diameter and 80 mm length made with steel of class 8.8.

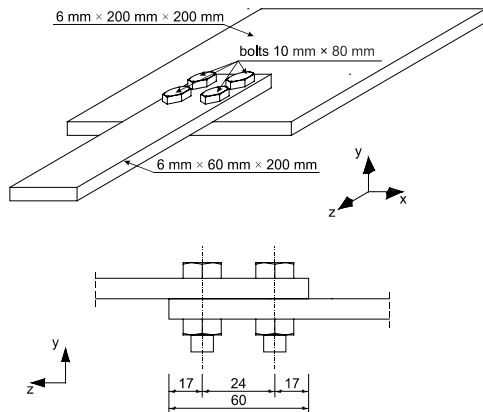

Fig. 1. Geometry of the bolted joint model

2.2. Experimental set-up

The experimental set-up for wave propagation measurements is presented in Fig. 2. For the excitation of elastic waves the piezoactuator Noliac CMAP11 with dimensions of $2 \text{ mm} \times 5 \text{ mm} \times 5 \text{ mm}$ and a resonant frequency in the range above 500 kHz was used. The piezoactuator was bonded to the side surface of the metal sheet using wax. A tone burst in the form of a five-peak sine with a central frequency of 100 kHz modulated by the Hanning window (Fig. 3) was produced by the function generator Tektronix AFG 3022 and then enhanced by the high voltage amplifier EC Electronics PPA 2000. The laser vibrometer Polytec PSV-3D-400-M was used for non-contact sensing of propagating waves. The velocity of surface vibration was measured in one point (as shown in Fig. 2) with a sampling frequency of 2.56 MHz.

Experimental measurements were carried out to examine the sensitivity of guided waves to the state of condition of the lap joint. The influence of the number of bolts and the value of the initial stress on recorded signals was studied. In order to ensure the controlled value of preload of bolts, a torque wrench was used. Ten different configurations were tested. A detailed list of values of torque moments for individual bolts as well as configuration of bolts is given in Table 1. In the first part of experiments fasteners were removed one by one (experiments #1 to #4) to simulate the bolt loosening. In the second part of tests (experiments #5 to #10) all fasteners

were applied in the lap joint. The value of torque moment used for preloading of bolts varied from 20 Nm to 120 Nm.

Table 1. Configuration of bolts and values of torque moments in experimental study

No.	Value of torque moment [Nm]			
	bolt S1	bolt S2	bolt S3	bolt S4
#1	20	20	20	20
#2	20	20	20	no bolt
#3	20	20	no bolt	no bolt
#4	20	no bolt	no bolt	no bolt
#5	20	20	20	20
#6	40	40	40	40
#7	60	60	60	60
#8	80	80	80	80
#9	100	100	100	100
#10	120	120	120	120

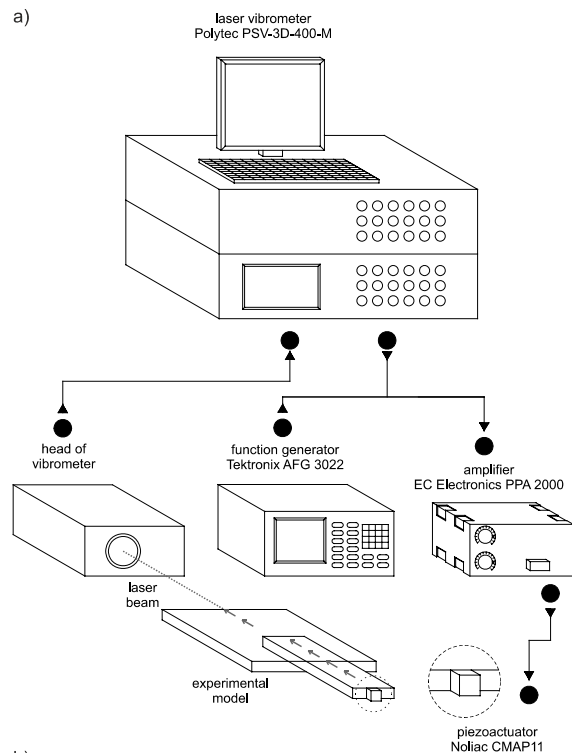

Fig. 2. Experimental set-up: a) scheme of measuring system; b) position of excitation and measurement point, numbering of bolts

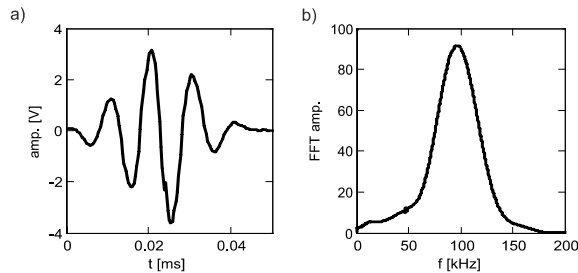

Fig. 3. Excitation signal: a) in time domain;
b) in frequency domain

3. FEM MODEL

The main problem of wave propagation modelling in bolted joints is contact. The bolt tightening generates friction between sheets, sheet and nut or bolt head and deformation of stud. In earlier studies [5, 8] the authors discussed modelling of wave propagation in lap connections with transverse wave excitation. Rhee et al. [8] proved an insignificant direct effect of prestressing force value to obtained wave propagation signals. However the main reason of such observations was a method of modelling of contact, i.e. constrain between bolt studs and lateral surface of plate holes was introduced. Huda et al. [5] applied different approach. They conducted a preliminary static analysis to determine the contact area. Mixed contact conditions based on results of numerical tests were introduced. The bolt heads and nuts were bonded with plates on the entire contact surface. Sheets were tied in a limited circular area around the holes and the friction contact between plates on the rest of the interface surface was considered. As a result, a good agreement of numerical and experimental results was obtained.

In this study numerical analysis was carried out using finite element method (FEM) commercial software Abaqus Explicit. Numerical FEM model is shown in Fig. 4. All elements of the joint were modelled using three-dimensional six-node and eight-node solid elements with reduced integration. Maximum size of the element was assumed as 2 mm and the mesh density was increased near the bolts. Calculations were performed in two stages. In the first step, the nonlinear static analysis was made to determine the contact conditions between the sheets, nuts and bolt heads. During the static analysis, the interaction between elements of the connection was taken into account by introducing the tangential and normal contact. Furthermore, the boundary conditions were introduced, i.e. one side of the joint was fixed. As the load was established, the pressure was applied to the stud in the direction of the bolt axis.

The second step was analysis of wave propagation. The constant surface-to-surface contact was adopted based on results of static calculations. It was assumed that the contact zone formed around each bolt have a circular shape and its radius

depends on the preload value. The maximum radius of the contact zone corresponding to bolt torque value equal to 120 Nm was established as 13 mm. The boundary conditions of the lap joint were assumed as free of all edges and surfaces. Calculations of wave propagation were made in two variants: without preload and with preload of bolts. The excitation signal was implemented as the time-varying surface load applied to 6 mm × 6 mm area of the side surface in the longitudinal direction (z -axis), as shown in Fig. 4a. Time step of numerical integration was assumed as 50 ns due to the stability condition of the central difference method.

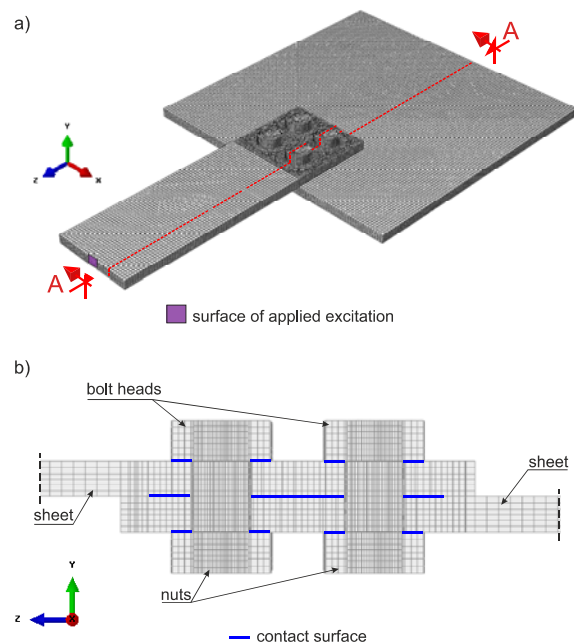

Fig. 4. Numerical model of the bolted lap joint:
a) axonometric view; b) cross section through connection with defined contact conditions

4. RESULTS AND DISCUSSION

Results of tests carried out for the constant value of bolt torque and variable number of fasteners are illustrated in Fig. 5. Experimentally registered velocity waveforms show a significant variation depending on the number of bolts, especially in the initial period of measurements from 0 ms to 0.2 ms. A significant decrease in the signal amplitude can be observed with subsequent removal of fasteners. With the reference to the connection with 4 bolts, the maximum registered amplitude was reduced by 18%, 54,5% and 79,9% for the connection with 3, 2, and 1 bolt, respectively. Similar results were obtained for numerical calculations (Fig. 6). However, the relative decline in signal amplitudes was smaller than in the case of experimental waveforms. For numerical signals the decreases in amplitudes with respect to the maximum vibration velocity obtained in the case of full number of bolts was 5,3%, 5% and 34,88 % for three, two and one bolts, respectively.

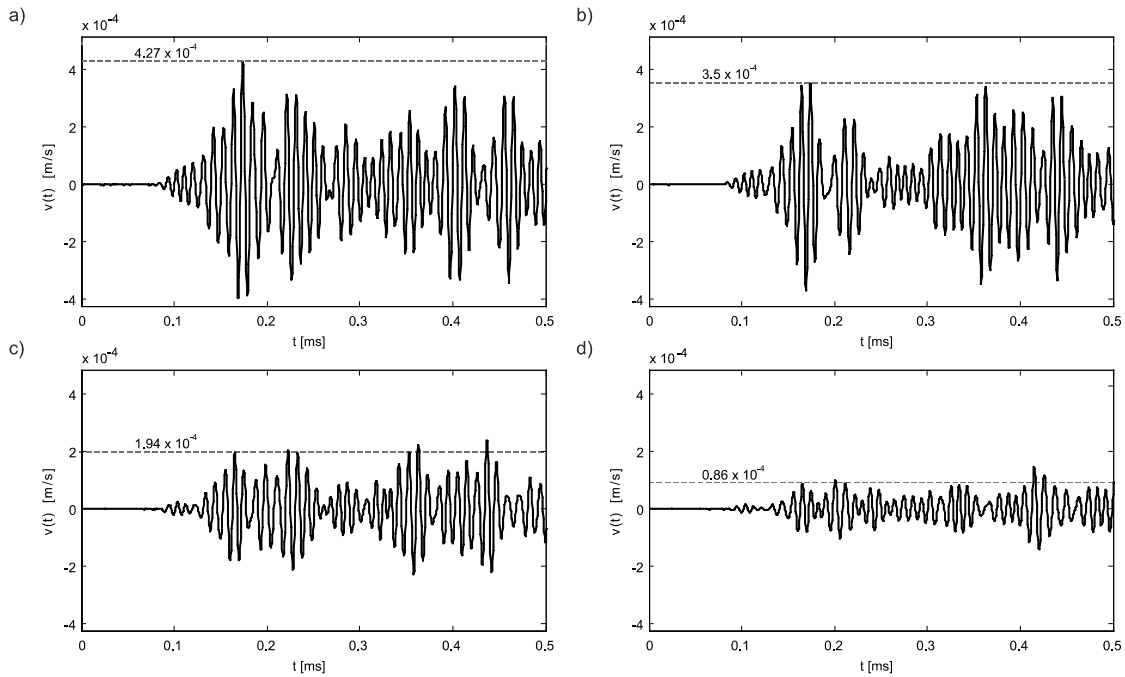

Fig. 5. Experimental signals measured for the lap joint with a) four; b) three; c) two; d) one tightened bolt

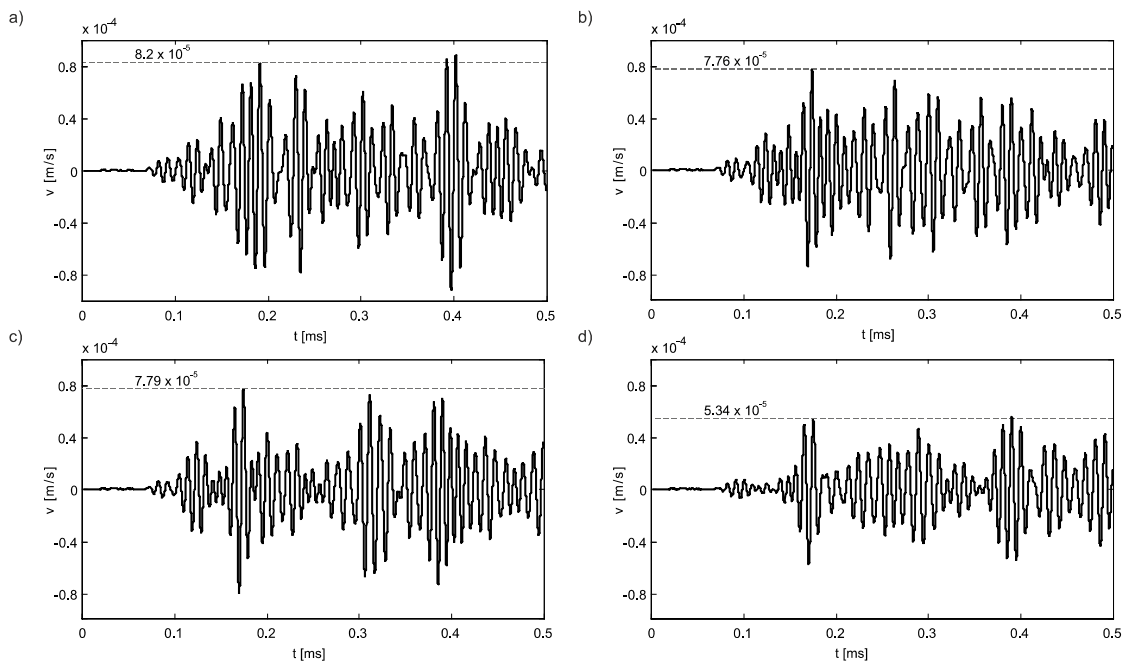

Fig. 6. Numerical signals calculated for the lap joint with a) four; b) three; c) two; d) one tightened bolt

The excitation of symmetric mode causes vibrations in the plane of the joint. However, when propagating wave reaches the discontinuity, the vibration amplitude in the transverse direction increases as a result of appearing of antisymmetric mode. This phenomenon is called the mode conversion. In Fig. 7 deformations at the selected time instances are shown illustrating the mode conversion in the considered lap joint. Due to different group velocity of symmetric and antisymmetric modes, propagated disturbances are separated. This can be clearly observed in a connection with one bolt (Fig. 5d).

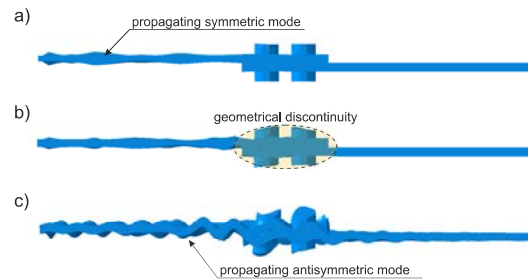

Fig. 7. Deformation of the lap joint at the time instance: a) 0.04 ms ; b) 0.055 ms ; c) 0.11 ms

Figure 8 shows time signals registered for the lap joint with 4 bolts progressively tightened by applying of torque moment of values varied from 20 Nm to 120 Nm with an increment of 20 Nm. The results given in Fig. 8 are limited for the initial part of measured signals in the time window from 0.075 ms to 0.2 ms for better visibility. A permanent decline in the amplitude value of the wave propagation signal with increasing bolt torque can be observed. In addition, a slight phase shift of the registered signals occurred with the increase of the torque value.

The fast Fourier transform (FFT) of experimentally measured wave propagation signals for different preload values are given in Figure 9a. There is visible a main lobe around the frequency of 100 kHz. The FFT amplitudes decreased with the increase of the bolt torque. Moreover, the frequency shift of the main lobe can be observed. The relationship between the maximum value of the FFT amplitude of the main lobe and the bolt torque level is illustrated in Fig. 9b. The plot is non-linear and shows a large exponential decay with the increase of the preload value.

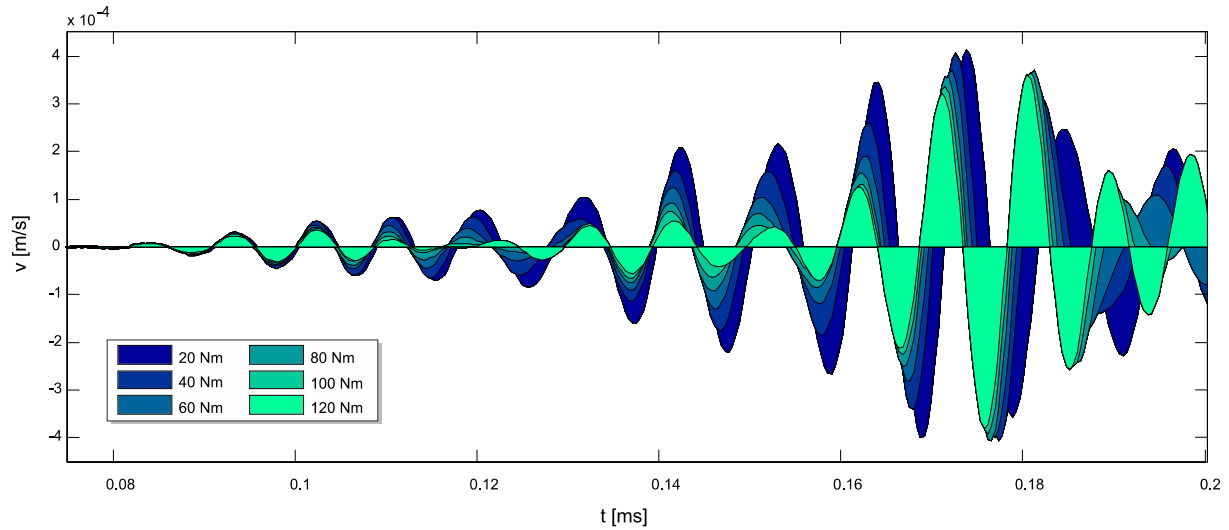

Fig. 8. Set of wave propagation signals collected during experiments for the lap joint with four bolts progressively tightened by applying of torque moment of values from 20 Nm to 120 Nm

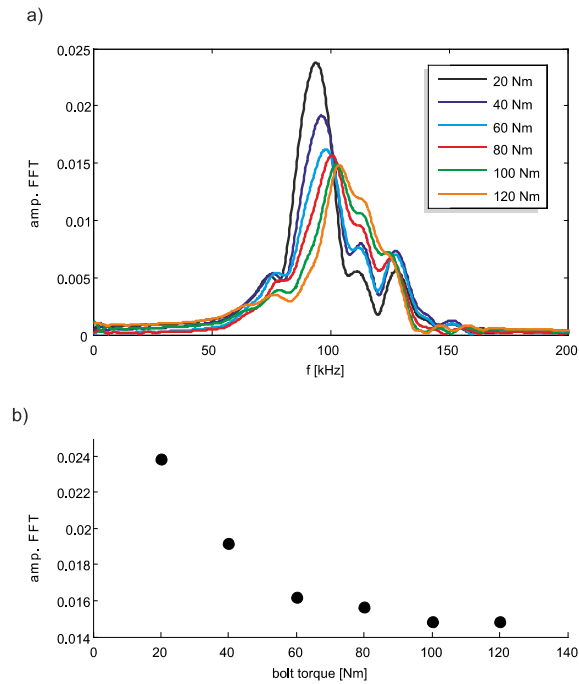

Fig. 9. Experimental signals in the frequency domain: a) Fourier transforms of measured wave propagation signals; b) relationship between FFT amplitude and bolt torque value

5. CONCLUSIONS

The paper presents numerical and experimental studies of elastic wave propagation in a laboratory model of the bolted lap joint. The research focused on the changes in wave propagation signals excited by a wave packet applied in the plane of the connection. Amplitudes of output signals and phase shifts in both time and frequency domains were analysed.

The study showed the possibility of using elastic waves in the context of diagnostics of bolted joints. The influence of the number of bolts and the value of the initial stress on the recorded signals was studied. The initial part of the wave propagation signal of a length of 0.2 ms was used for the assessment of the joint condition. Changes in waveforms recorded in joints with different number of fasteners were observed both in numerical calculations and experimental studies. A decrease in the signal amplitude was detected with subsequent removal of fasteners. Experimental tests on the lap joint with the constant number of fasteners and varied bolt torque level showed exponential decrease in the signal FFT amplitude with the increasing preload value.

BIBLIOGRAPHY

- [1] Jhang K.Y., Quan H.H., Ha J., Kim N.Y. *Estimation of clamping force in high-tension bolts through ultrasonic velocity measurement*. Ultrasonics, vol. 44 (2006), pp. e1339–e1342.
- [2] Conradi M.S., Miller J.G., Heyman J.S. *A transmission oscillator ultrasonic spectrometer*. Review of Scientific Instruments, vol. 45, no. 3 (1974), pp. 358–360.
- [3] Heyman J.S. *A CW ultrasonic bolt-strain monitor*. Experimental Mechanics, vol. 17, no. 5 (1977), pp.183–187.
- [4] Amerini F., Meo M. *Structural health monitoring of bolted joints using linear and nonlinear acoustic/ultrasound methods*. Structural Health Monitoring, vol. 10 (2011), pp. 659–372.
- [5] Huda F., Kajiwarra I., Hosoya N., Kawamura S. *Bolt loosening analysis and diagnosis by non-contact laser excitation vibration tests*. Mechanical Systems and Signal Processing, vol. 40 (2013), pp. 589–604.
- [6] Wang T., Song G., Wang Z.G., Li Y. R. *Proof-of-concept study of monitoring bolt connection status using a piezoelectric based active sensing method*. Smart Materials and Structures, vol. 22 (2013), Article ID 087001.
- [7] Seunghee P., Chung-Bang Y., Yongrae R., Jong-Jae L. *PZT-based active damage detection techniques for steel bridge components*. Smart Materials and Structures, vol. 15 (2006), pp. 957–966.
- [8] Rhee I., Choi E., Roh. Y-S. *Guided wave propagation introduced by piezoelectric actuator in bolted thin steel members*. KSCCE Journal of Civil Engineering, vol. 16, no. 3 (2012), pp. 398–406.

Calculations were carried out at the Academic Computer Center in Gdańsk.



mechanical structures and non-destructive testing.



and structural health monitoring.

Rafal KĘDRA, M.Sc. graduated civil engineering at the Department of Structural Mechanics and Bridge Structures of Gdańsk University of Technology. Since October 2014 he continues his education as a Ph.D. student. His main interests are modelling of

Magdalena RUCKA, Ph.D., D.Sc. is an assistant professor at the Department of Structural Mechanics and Bridge Structures of Gdansk University of Technology. Her scientific interests are focused on dynamic of structures, wave propagation and development of new techniques for damage detection

