

Properties comparison of rubber and three layer PTFE-NBR-bronze water lubricated bearings with lubricating grooves along entire bush circumference based on experimental tests

Wojciech Litwin wlitwin@pg.gda.pl

Gdansk University of Technology, Faculty of Ocean Engineering and Ship Technology,
ul. Narutowicza 11/12,
80-233 Gdansk,
Poland

Key words: water lubricated bearings, stern tube bearings, propeller shaft bearings, marine bearings

Abstract:

Water lubricated bearings have been in industrial use for well over a century. During the last decade their traditional range has been expanded with new, modern products. Despite that fact, certain solutions continue to employ the standard rubber bearing with lubricating grooves located along entire bush circumference.

The work presents experimental research conducted on comparable sliding bearings with lubrication grooves along entire bush circumference, assessing them against a different, modern solution. Movement resistance, pressures in bearing interspace and shaft orbits were measured and analyzed. It was proved that classic bush geometry is not appropriate for hydrodynamic lubrication.

1. Introduction

Water lubricated bearings have been used in shipbuilding, hydropower and on water pump shafts for well over a century (Orndorff [1]). In recent years, thanks to intensive research we have witnessed a significant increase in the body of knowledge concerning this bearing type. The research work has been carried out by both scientific centers, as well as R&D departments of bush manufacturers (Orndorff [2-3], Laskey [4-5], Ford [6], Yamjo [7]). This has allowed for increasing both durability and reliability of this bearing type [8]. As a result, ship classification societies have agreed to reducing the length of stern bushes on ship propeller shafts from the minimum of four journal diameters ($L/D=4$) to two journal diameters ($L/D=2$) for a selected, tested group of materials. Half the bush means half the price and today water lubricated bearings may be found in an ever growing number of machines and equipment.

Not without impact on the growing popularity of water lubricated bearing systems is their lower price in comparison with the widely used sealed systems with bushes made of white metal and lubricated with oil (Lagersmit [9]). Attempts to find savings by replacing bearing alloys with composites did not prove to be successful, as significant temperatures occurring in oil lubrication film caused delamination of the sliding material (Litwin [10]).

In hydropower and shipbuilding attention is frequently drawn to shaft misalignment which may appear due to manufacturing faults, improper assembly, as well as deformation of the entire machine (e.g. deforming of ship hull in rough waters). Therefore, using elastic, supple bushes appears to be a safer option, since in the event of shaft misalignment such a bush will deform elastically, preventing occurrence of stress concentrations which frequently cause rapid wear of both the bush and the journal of the shaft. However, conducted theoretical analysis proved that use of elastic bushes limits bearing's hydrodynamic capacity (Litwin [11]). Experiment based research carried out for various bush types, established that their hydrodynamic capacity may be as high as 0.8 MPa (Litwin [12]). There is no certainty, however, whether local contact does not take place between the journal and its bush, especially at the bush's edge.

Bushes of water lubricated bearings may be divided into four groups based on the value of the elasticity module which, among others, has impact on bearing's hydrodynamic capacity (Litwin [11]).

- Supple materials with the elasticity module below 1000 MPa, such as rubber (NBR) or elastomers. Under the impact of hydrodynamic pressure occurring in the lubrication film, bush deformation may be of a level which is close in size to the thickness of the lubrication film in those areas of the bush where no deformation occurs. Bush deformation has significant impact on the magnitude of bearing's hydrodynamic capacity.
- Materials of average flexibility with the elasticity module in the range of 1000 to 3000 MPa - polymers, foil bearings (Hryniewicz [13]). Bush deformation has limited impact on bearing's hydrodynamic capacity.
- Materials of high stiffness (mainly composites) with the elasticity module of approximately 4000 and more. Bush deformations between ten to twenty percent of the lubrication film thicknesses which only slightly limit bearing's hydrodynamic capacity.
- Materials with such a high value of the elasticity module (Łubiński [14], Litwin [15], Cui [16]) that they practically do not deform under the impact of hydrodynamic pressure in the lubricating water film.

The last two decades witnessed invention of new, modern bearing materials and optimization of bearing geometry. Despite that fact, certain solutions continue to employ the classic rubber bearing with lubrication grooves running along entire circumference of the bush. It is widely considered that

this solution is especially suitable for handling light to medium loads placed on journal bearings of pumps and water turbines frequently equipped with vertical shafts and lubricated with such working fluids as dirty river water containing solid particles pollutants.

The longitudinal lubrication grooves of the bush have a very important role. They allow for easier movement of the lubricating fluid, i.e. water, through the bearing. This is important since the heat generated in the friction zone must be absorbed by the lubricating fluid as heat exchange through the polymer bush to the casing is limited. In addition, the grooves facilitate the process of washing out the product of wear and dirt particles from the friction zone. Frequently, these pollutants settle inside the grooves without causing damage to journal and bush.

2. Origin and purpose

Various types of water lubricated sliding bearings have been experimentally tested in recent years at the Gdańsk University of Technology - including both stiff composite bearings, as well as elastic, plastic ones (Litwin [10-12,15,26]). The research unequivocally established that a correctly designed water lubricated journal bearing may work in fluid film friction range under conditions of loads and speeds typically encountered in practical applications. Unfortunately, low viscosity of the lubricating fluid (water), as well as the absence under typical working conditions of the effect of increased viscosity as a function of pressure, results in the fact that despite theoretical possibility of obtaining full hydrodynamic lubrication, the minimum water film thickness remains very small rarely exceeding few micrometers. As it seems from practical experience, this may mean that there is contact between the journal and the bush, especially at the bearing's edge.

Scientists all over the world have been investigating advantages and shortcomings of various sliding materials for many years. Rubber bush bearings offer numerous benefits and are currently widely used in shipbuilding, power industry and other sectors (Orndorff [1-3], Wang [17, 18], Xijin [19], Dong [20]). The same applies to polymer (Litwin [10-12], Ginzburg [21]) and composite (Ford [6]) bush bearings. There are also multi-layered materials. This situation makes it possible to selectively obtain desirable bearing properties. Many scientific research centers conduct research on other types of water lubricated bearings. These include mainly ceramic (Łubiński [14], Nisaka [22], Jahanmir [23], Li [24], sintered metal alloy (Litwin [15], Cui [16], Jia [25]) and foil bearings (Hryniewicz [13]).

The planned research goal was to investigate the properties of three selected water lubricated sliding bearings equipped with lubrication grooves along the entire bush circumference, as well as to conduct comparison of the results with those of bearing with differing geometry, facilitating generation of load carrying lubricating film. The tests were carried out on real-life scale bearings, 100 mm in journal diameter and the proportion of length to diameter equal two ($L/D=2$). The bearings were tested under conditions approaching those found in actual use (Table 1).



3. Characteristic of investigated bearings and research methodology

The three investigated bearings were equipped with eight, longitudinal, open lubricating grooves placed along entire bush circumference (Fig.1). The bearing used for comparison of obtained results was equipped with lubricating grooves only in the upper, unloaded bush half. Specifications of the tested bearings are presented in Table 1.

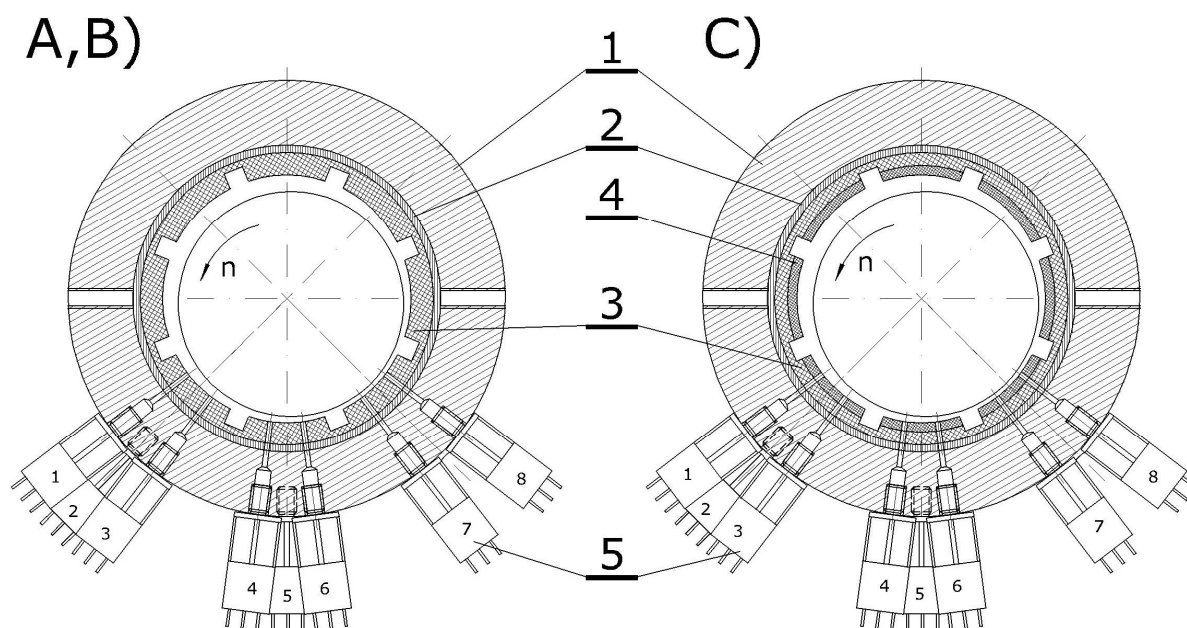

Fig. 1. Tested bearings; A, B - rubber bearings (NBR), C- three layer bearing PTFE - NBR bronze, shown locations of sensors measuring pressure in lubrication film; 1 - steel sleeve, 2 - bearing steel sleeve with a factory mounted bearing, 3 - NBR, 4 - PTFE layer, 5 - pressure sensors (in two groups of eight)

Table 1. Tested bearings

lp	Bearing type and geometry, sliding surface roughness high before / after running-in [μm]	Average diameter clearance [mm]	Details	Working conditions
A	Rubber (NBR) in bronze shell, 6.4 / 1.6	0.8 ÷ 1	Various manufacturers, different surface quality.	Shaft speed rev/s: 1, 3, 5, 7, 9, 11 Bearing load MPa: 0.1, 0.2, 0.4, 0.6 Lubricant: fresh water, temperature 18°C
B	Rubber (NBR) bronze shell, 3.2 / 1.6	0.3 ÷ 0.4		
C	PTFE-NBR-Bronze shell 3.4 / 1.6	0.48 ÷ 0.55	The same manufacturer, different bush geometry (fig. 2)	
D	PTFE-NBR-Bronze shell, five grooves in upper part of the bush 3.4 / 1.6	0.5 ÷ 0.65		

The tests were carried out on two NBR bearings (A and B) of different manufactures. The bearings varied noticeably from each other in the degree of their sliding surface smoothness. In the case of the

first bearing (A,) the surface was visibly marked by traces of machining attempts (Fig. 2A). The three-layer bearings (C and D) came from a single manufacturer but differed in geometry. For the purpose of comparison, a bearing with a relatively elastic bush and similar bearing clearance was selected (D). All of the tested bearings are accepted for use in shipbuilding by various classification societies from all over the world. Bearings C and D are more expensive than NBR bearings. Their higher price stems from, among others, the high-tech character of used materials, created as a result of intensive R&D work by a commercial company.

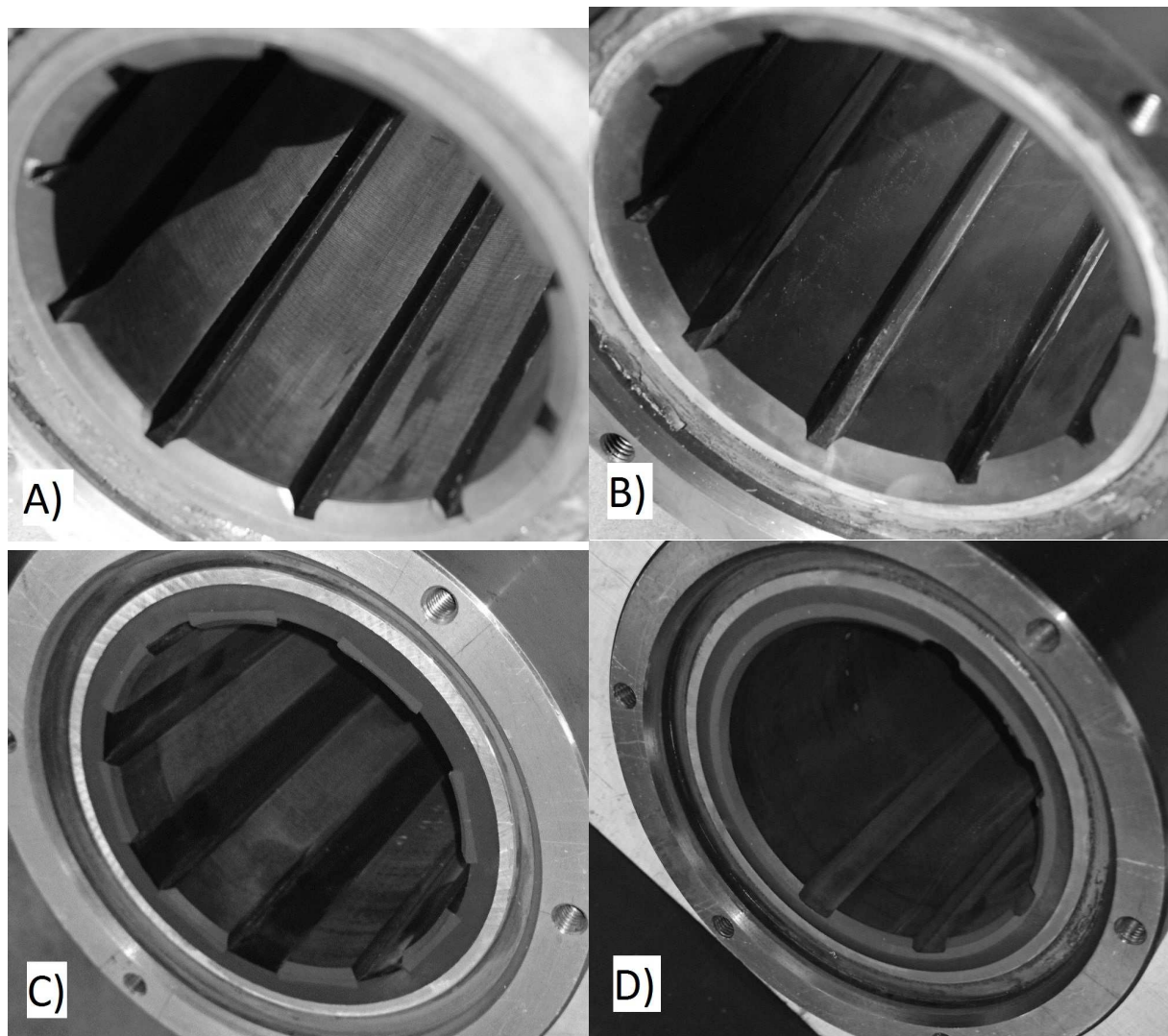

Fig. 2. Photographs of tested bushes, A, B – rubber (NBR) bearings, C,D- three-layer bearing PTFE-NBR-bronze

The research tests of water lubricated sliding bearings were carried out on a test rig of own design and construction. Its most important fragment is presented below (Fig.3.) (Litwin [26]). The main shaft was made of marine grade stainless steel X10CrNi18-8, which is frequently used in this type of solutions. The drive was provided by an electric engine with reduction gear, controlled through an encoder. Thanks to this, it is capable of reaching maximum torque of approximately 160 Nm.

The test rig offers extensive possibilities. It allows for recording friction moment of tested bearing (with following calculations of friction coefficient), shaft trajectory, clearance circle, as well as pressure distribution at selected locations in the space between bush and journal. However, the rig has also certain limitations, resulting from the method of applying radial force on the tested sliding bearing. The load is applied through two rollers equipped with ball bearings. Due to this, the recorded value of the friction coefficient is increased by additional factors - the resistance of movement of the load applying rollers, as well as of two sealing rings which allow for supplying water inside the enclosed area of the bearing assembly. This is why the moment of friction measurement is marked by certain error, and the measurement accuracy increases with higher levels of resistance, for example, during start-up. In addition, the method of supporting the bearing at two points may lead to its misalignment in relation to the shaft, for instance, due to pressures appearing in the bearing's lubrication film. Similar limitations are present on most test rigs of this type which are employed in scientific research centers all over the world [Yamjo [7], Łubiński [14], Wang N. [17], Wang Y. [18], Gao [27]].

The test rig allows for conducting measurements of pressure distribution in the space between the bush and journal. This is possible thanks to pressure sensors installed in the sleeve. Due to their size, the sensors were installed in groups, as close to each other as possible, symmetrically on the left and the right side of the bearing (Fig. 3, element 5).

The test rig was equipped with two pairs of distance sensors on both sides of the bush (Fig.3. elements 6), which allowed for conducting trajectory measurements of shaft orbits during bearing operation. After disconnecting the arm with friction force sensor, pressure sensors wires and the water supplying pipes(Fig. 3, element 7), it is possible to rotate bush together with distance sensors (under continuous radial load) on shaft and record the outmost location of the journal inside the bush, which is often referred to as the clearance circle. This is a unique characteristic of the test rig which allows for conducting evaluations of bush shape faults (Fig. 10 – 12).

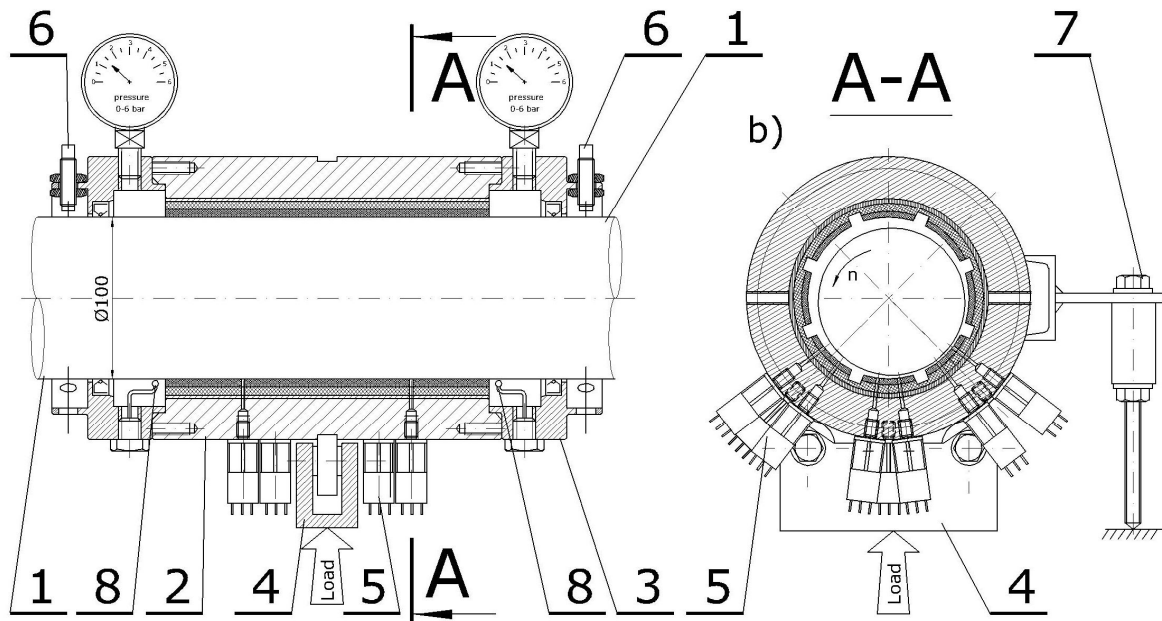

Fig.3. Tested bearing assembly - test rig; 1- stainless steel main shaft, 2- steel sleeve - bearing casing, 3- covers with sealing rings, 4- radial force application unit, 5- sensors measuring pressure between journal and bush, 6 – sensors measuring distance between journey and bush, 7- arm and sensor for measuring moment of friction, 8 - sensors of water temperature flowing through the bearing

4. Results

Prior to testing, each new bearing was run-in. The bush surface became smooth after only a few dozen hours of work at low revolution speed with gradually increasing load.

Selected measurement results of movement resistance, shaft trajectories and pressure distribution in the lubrication film are presented below (Fig. 4 – 12).

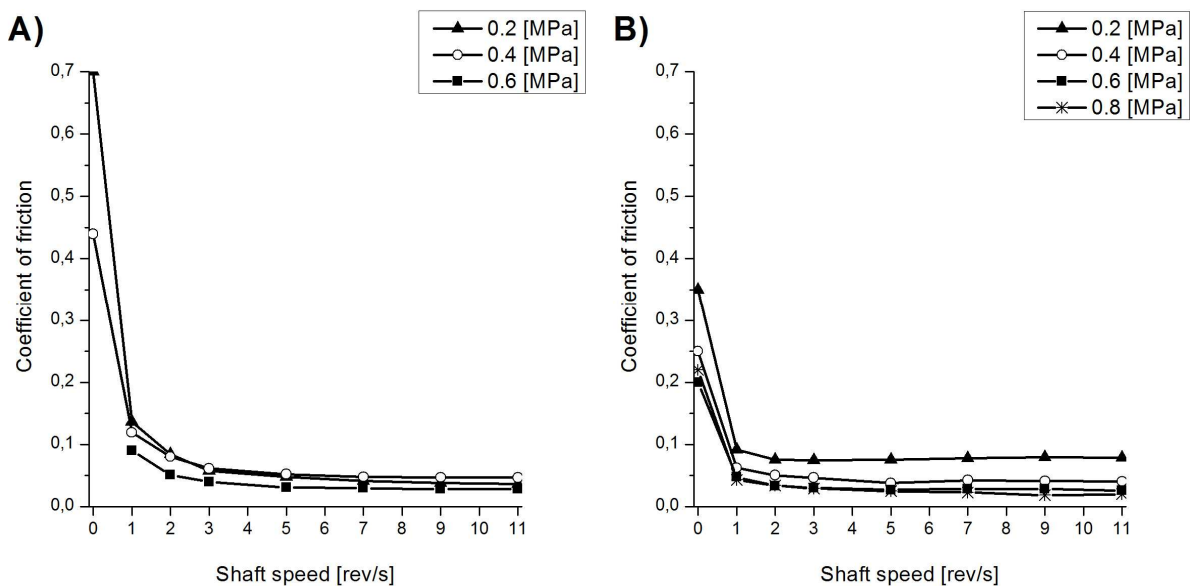

Fig. 4. Friction coefficient diagram of bearings with grooves along full bush circumference (A, B)

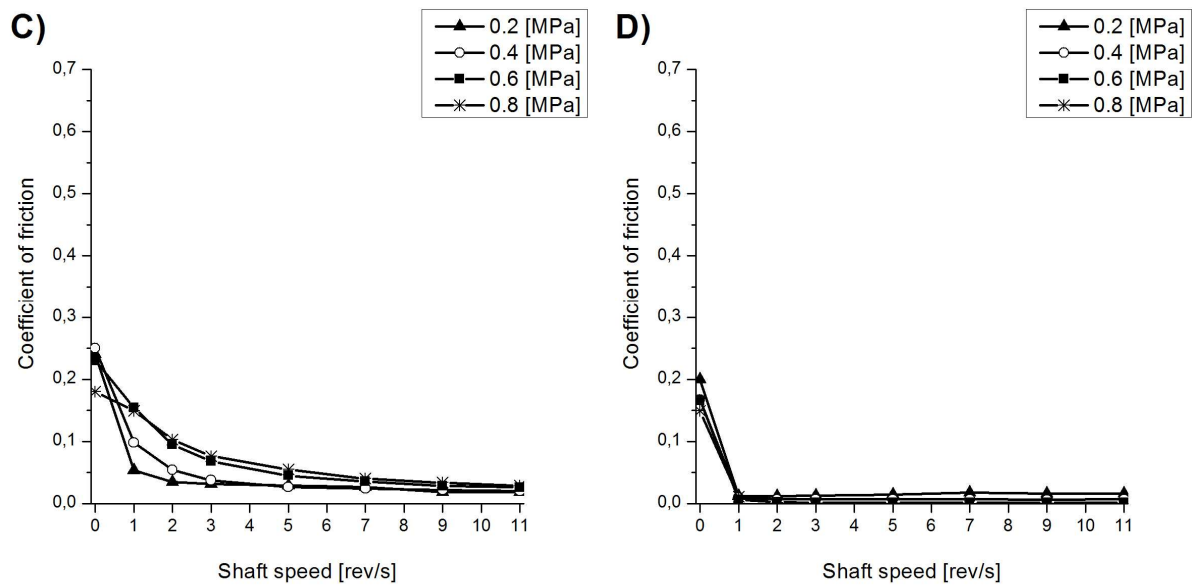

Fig. 5. Friction coefficient diagram of bearings with grooves along full bush circumference (C) and friction coefficient diagram of bearing with grooves in upper half of bush (D)

Measurement of pressure distribution in the bearing interspace is very useful as it helps to identify if the bearing is working under hydrodynamic or mixed lubrication regime. The diagrams present pressure distribution in the lower bush half (Fig. 6 - 8). During the measurements, it was observed that if the hydrodynamic pressure built up in a particular bearing area, then even after the drive was turned off and the shaft stopped, the sensors continued to display certain pressure value for a few hours. This was due to tight adherence of the elastic, run-in bush to the shaft. In order to make the results credible, the friction surfaces were always separated between measurements by slight lifting of the journal over the bush. At this point, it was checked whether the recorded pressure was equal to the surrounding pressure and only then, once the operating conditions stabilized a few minutes later, the measurement was taken. Selected pressure distribution diagrams are presented below (Fig. 6 - 8).

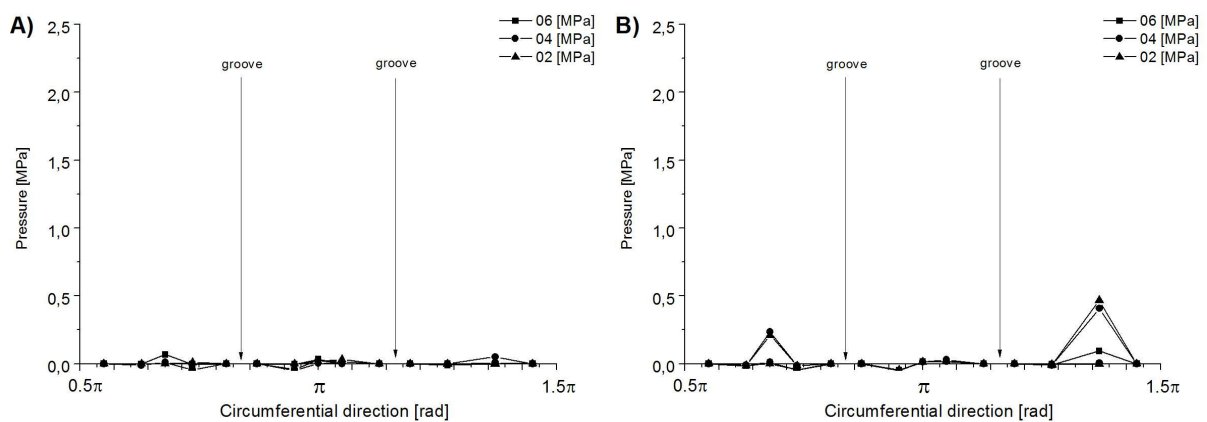

Fig. 6 Pressure distribution diagrams in selected bearings with grooves along full bush circumference (A and B); shaft speed 11 rev/s

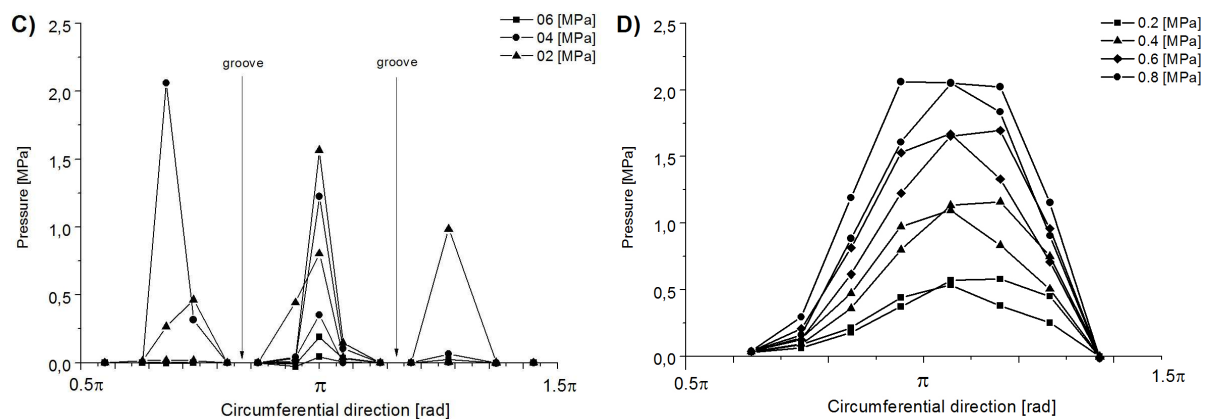

Fig. 7 Pressure distribution diagrams in tested three layers bearing with grooves along full diameter(C), and with the grooves in upper part (D); shaft speed 11 rev/s

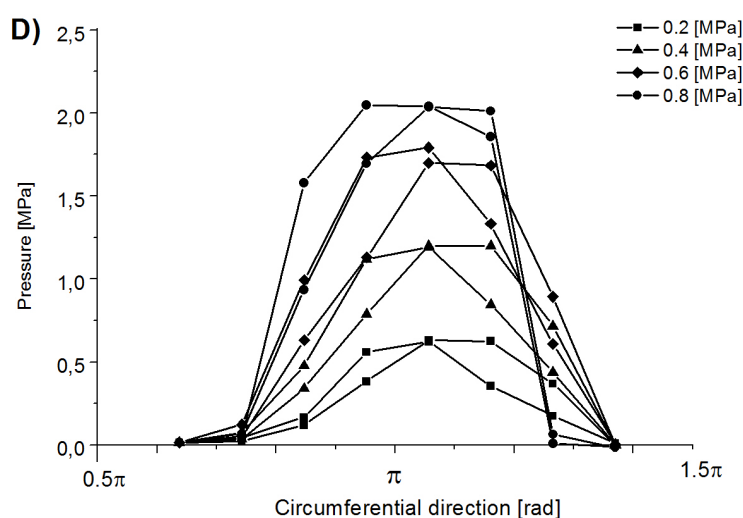

Fig. 8 Pressure distribution diagram in bearing with grooves in upper half (D); shaft speed 3 rev/s

Pressure values in the film were recorded in two symmetrical areas, on the left and the right side of the bush. This is why each of the diagrams should have two pressure distributions for every load value for which measurements were conducted. However, as it turned out the measured values differed significantly from each other. This was due to shaft misalignment, and presumably from faults in bush's shape which can be noticed on shaft trajectory and clearance circle diagrams presented below (Fig. 9 -12).

Hydrodynamic pressure distributions were successfully recorded for bearings B, C and D. The hydrodynamic pressure values were negligible for bearing A.

In case of the bearing with grooves only in the upper part (D), presented are diagrams for two values of shaft revolution speed ,3 and 11 rev/s (Fig. 7D and 8).

The test rig allows for conducting measurements of shaft trajectory and clearance circle (extreme position of journal in shaft in the function of applied load) on both sides of the bush. Selected measurements results are presented below (Fig. 10-12)

Figure 10 illustrates the impact of pause in operation on the value of static friction coefficient for bearings A and C.

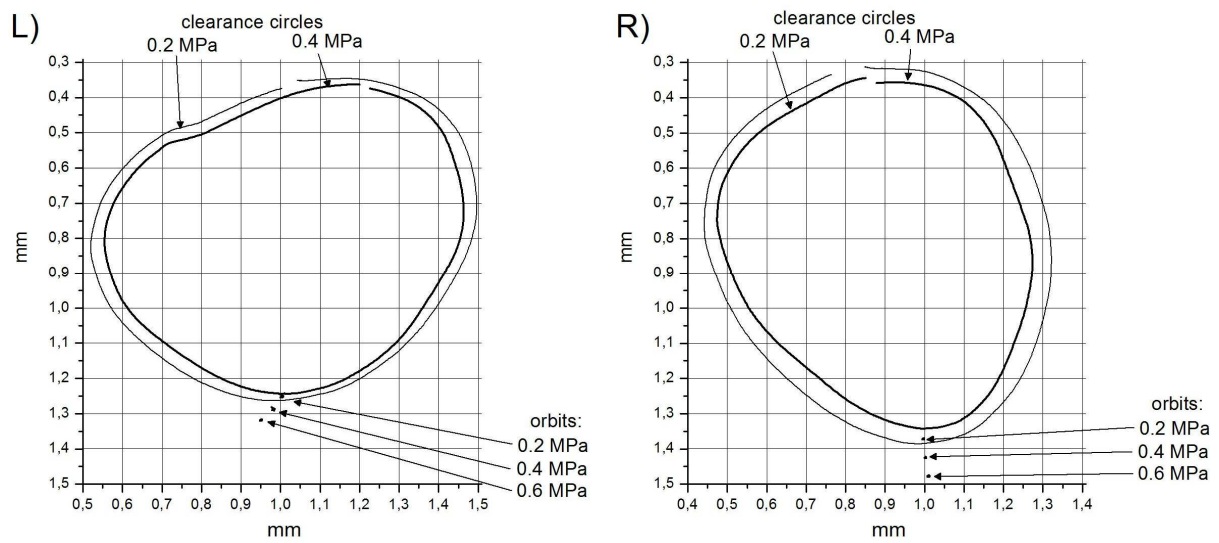

Fig. 9. Shaft orbits in measured clearance circles, bearing A for load 0.2 – 0.6 MPa, shaft revolution speed 11 rev/s

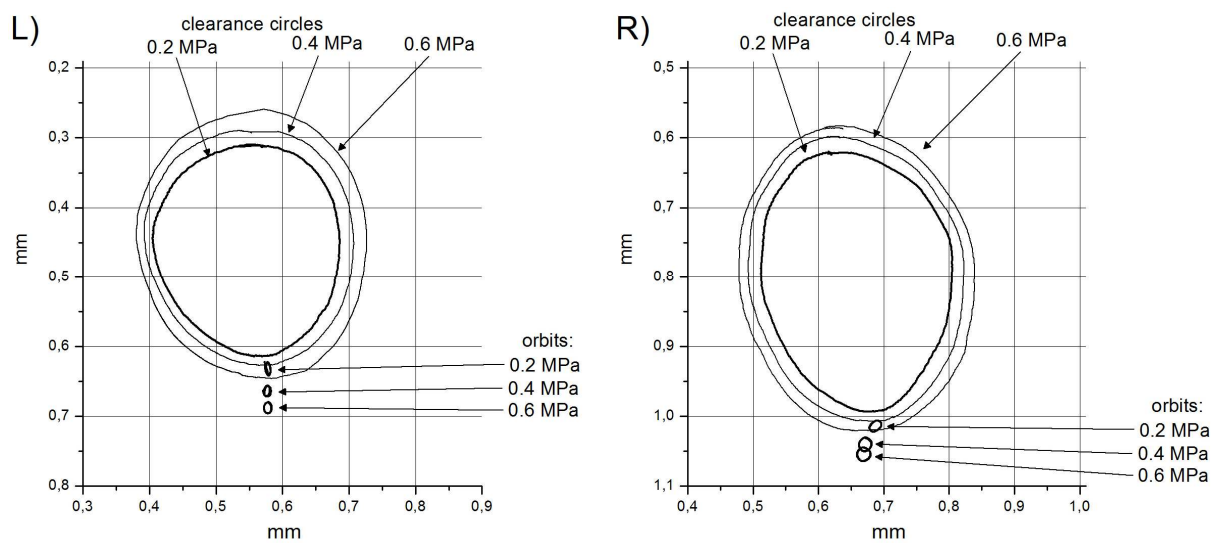

Fig. 10. Shaft orbits in measured clearance circles, bearing B for load 0.2 – 0.6 MPa, shaft revolution speed 11 rev/s

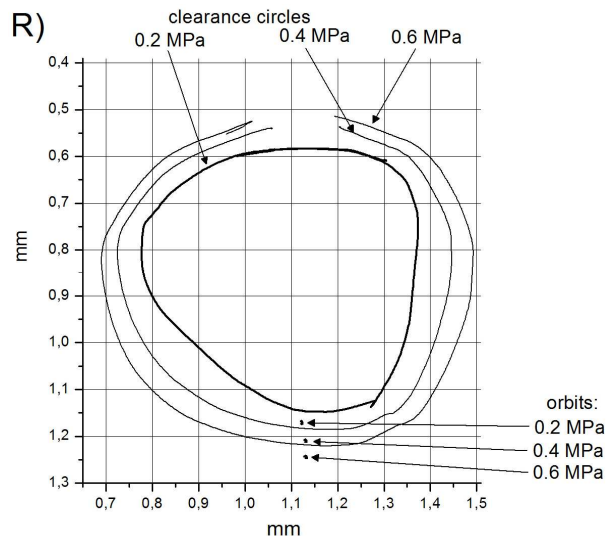
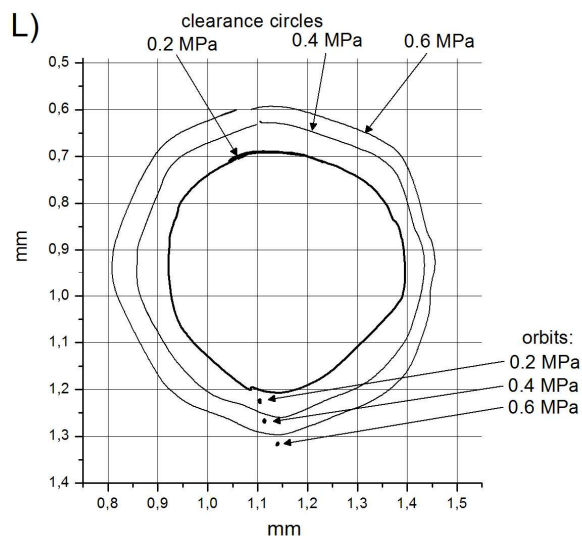

Fig. 11. Shaft orbits in measured clearance circles, bearing C for load 0.2 – 0.6 MPa, shaft revolution speed 11 rev/s

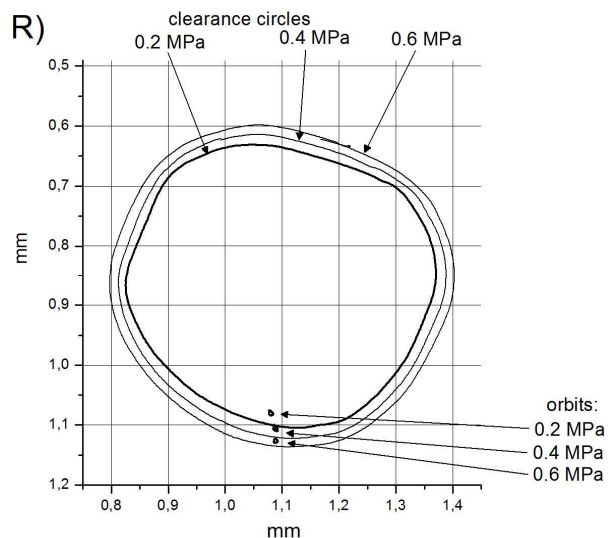
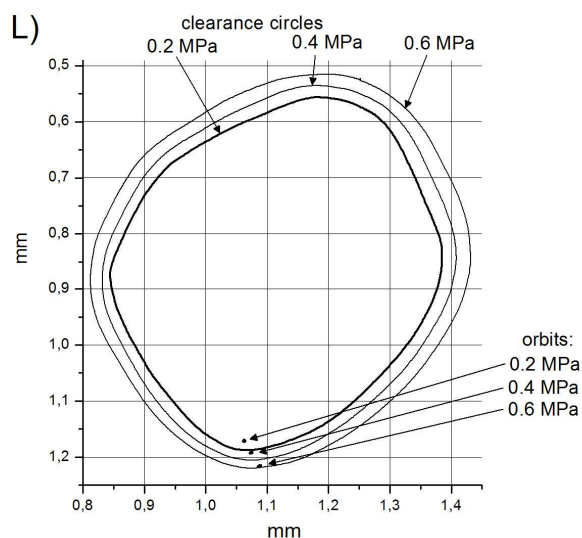

Fig. 12. Shaft orbits in measured clearance circles, bearing D for load 0.2 – 0.6 MPa, shaft revolution speed 11 rev/s

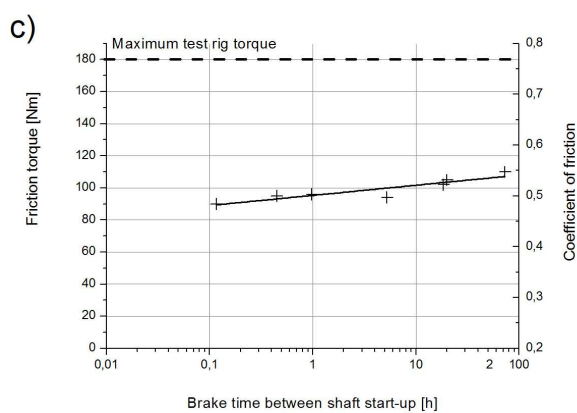
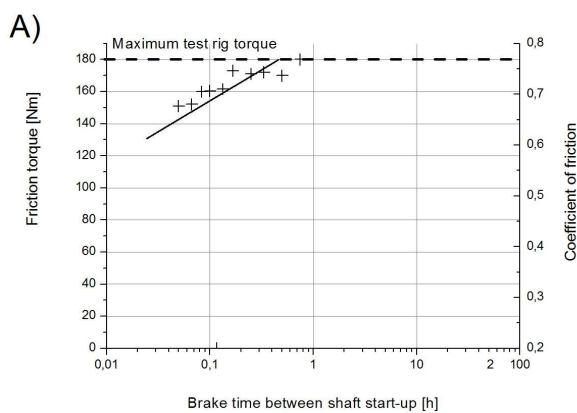

Fig. 13. Measured coefficient of friction during shaft start-up, load 0.2 MPa;
A - NBR bearing, C - Three layer bearing

5. Discussion

Due to problems regarding precise measurements of friction coefficient, the obtained results make it difficult to interpret very small values of friction coefficient and do not allow to unequivocally determine when fluid film friction occurred and whether locally mixed friction might have also taken place.

Out of the entire group of tested bearings it is only the bearing with grooves in the upper, unloaded part of the bush (D) which has characteristic of friction coefficient typical for hydrodynamic lubrication.

Three layer bearings with PTFE sliding surface also have lower coefficient of friction values during start-up than do bearings equipped with NBR bushes (Fig. 13). In conducting the tests, there was concern that after smoothing of the sliding surface, the coefficient of friction value would increase as a possible consequence of the stick-slip phenomenon which occurs in other sliding pair combinations (polymers, NBR), as was observed during numerous, earlier tests performed on various materials. Symptoms of this phenomenon were not witnessed in the three-layer bush bearing. The slip-stick phenomenon was noticed in the first of the tested bearings equipped with NBR bush (A). The values of static friction coefficient following longer pause in work are significant (Fig. 13).

Hydrodynamic pressure appeared in bearing D even at low journal revolution speed of 3 rev/s (Fig. 8). This was due to better hydrodynamic properties of this bearing's geometry.

In the NBR bearings with grooves (A and B), no load carrying lubrication film formed even under very favorable working conditions – small pressure and maximum journal speed (0.2 MPa and 11 rev/s – Fig. 6).

Considerable discrepancies in the values of pressure measured by the sensors located in two areas, especially in the case of bearing C (Fig. 7c), point to journal misalignment during work. It may be suspected that in the case of the bearing with grooves along the entire circumference (C), the bush had a certain fault in shape and some bearing fragments were working in mixed friction regime, while in other parts hydrodynamic pressure did build up (Fig. 7c). Such suspicions are confirmed by movement resistance diagrams (Fig. 5c). The measured friction coefficient characteristic for the pressure of 0.2 MPa is the closest to typical fluid film friction distribution. Analysis of pressure values in lubrication film (Fig. 7c) confirms this suspicion. It turns out, that pressure measured in central part of the bearing reaches the values of 1 and 1.5 MPa in two measurement areas.

In the bearing with grooves located in the upper bush half (D) hydrodynamic lubrication occurred in a wide range of working conditions. It may be suspected that mixed lubrication took place in the bushes with grooves (A, B, C) working at loads greater than 0.2 MPa. This is also indicated by shaft trajectories and measured pressure distributions.

Measurements of clearance circles (extreme journal locations in bush) showed that the bushes deform significantly with increased applied load (Fig. 9 – 12). Moreover, there is also evidence of significant fault in bush shape (non-cylindrical form). The difference in the value of average diameter clearance on both sides of the bush may amount to over 30%. Such a deviation has influence on bearing's hydrodynamic properties. The lubrication hydrodynamic film forming in the bearing is not symmetrical and causes misalignment of the tested bush in relation to the shaft (possible because of the load application method used on the test rig).

In case of the bearing with grooves in the upper bush half (D), it is possible to estimate the approximate thickness of the lubrication film based on its shaft trajectory diagram (Fig. 12). In case of the remaining bearings, the orbits are located outside measured clearance circles, which points to significant bush deformations and suspected presence of mixed friction. Such effect occurs even in bearing C under the pressure of 0.2 MPa and journal speed of 11 rev/s (Fig. 11). After analyzing the friction coefficient and pressure distribution diagrams it may be concluded (as it was already acknowledged earlier) that it is probably working in the hydrodynamic lubrication regime. There is a strong possibility of local sliding surface separation resulting forming hydrodynamic pressure, while the remaining part of the bearing is working in the mixed friction range. This suspicion is confirmed by the fact that the pressure sensors located on the two surfaces recorded significant differences in the values of forming hydrodynamic pressures (Fig. 7c).

6. Conclusions

The conducted research work identifies certain weaknesses of rubber bearings (NBR). Their measured friction torque was higher than in case of three-layer and polymer bearings tested in the past (Litwin [10,12]). This was probably the result of working under mixed lubrication regime. Shaft orbits are small and are located outside experimentally measured clearance circle, as a consequence of significant deformation of the very elastic rubber bush. In fact, there is no measured hydrodynamic pressure in the NBR bearings (A and B). This is probably due to very narrow bush pads and grooves located on the bush perimeter. At greater loads, the pressure sensor holes may even become blocked by the shaft causing no measured signal changes.

Rubber bearings, with molded bush grooved along the entire diameter have a number of advantages, as well as disadvantages. One important benefit is their relatively low price. On the other hand, the mixed lubrication regime results in significant bush wear and in some cases even in shaft wear.

The bearings with three-layer bushes performed significantly better. While they offer the advantages of NBR bearings, they also lack one important disadvantage, i.e. the high value of

movement resistance, especially during start-up. The time between succeeding shaft starts also does not have any substantial impact on the values of movement resistance during start-ups.

It was empirically proven that bush geometry does have crucial impact on the resistance of movement. In fact, it is the decisive factor determining whether or not hydrodynamic phenomena appear in a bearing.

In case of horizontal shaft bearings where the load direction is usually known, it is recommended to use a bush in which the grooves are present only in the upper, unloaded part.

The question of durability when lubricating with fluid containing solid dirt particles remains to be investigated. Such research is planned to be carried out in the future.

In analyzing the obtained results, one may reach a conclusion that bearings with grooves located along bearing's entire circumference should be used in those bearings which work under light loads where it's difficult to unequivocally determine the load direction, e.g. in vertical shafts of certain pumps and water turbines.

References

- [1] Orndorff R L. Water-lubricated rubber bearings, history and new developments. *Nav Eng J* 1985: 39–52.
- [2] Orndorff R L. From lab to field: new high performance water lubricated bearings. In: *Proceedings of world tribology conference III*. Washington; 2005.
- [3] Orndorff R L. New UHMWPE / rubber bearing alloy. *ASME J Tribol* 2000; 122:367–73.
- [4] Laskey Keith. The non-metallic bearing—what you need to know. *World Pumps*; August 2006: 36–8.
- [5] Laskey K. Nonmetallic Pump Bearings. *Pumps & Systems*; May 2008.
- [6] Ford A. New composite seal and bearing technology for better performance. In *detail*. *Wartsila Tech J* 2012;01:2012
- [7] Yamjo S, Kikkawa F. Development and application of PTFE compound bearings. In: *The annual conference of the dynamic positioning*. Houston, September 28–30; 2004.
- [8] 13 Years of Pollution Free Bearing Performance for Grand Princess Cruise Ship. Published at: <http://www.maritime-executive.com>, April 27, 2011.
- [9] Lagersmit R. Closed oil-lubrication stern tube system replaces merchant ship's water-lubricated bearings. *Sealing Technology*, September 2010.
- [10] Litwin W. Water-lubricated bearings of ship propeller shafts problems, experimental tests and theoretical investigations. *Pol Marit Res* 2009; 16: 42–50.
- [11] Litwin W. Influence of main design parameters of ship propeller shaft water lubricated bearings on their properties. *Pol Marit Res* 2010; 17: 39–45.



- [12] Litwin, W. Experimental research on water lubricated three layer sliding bearing with lubrication grooves in the upper part of the bush and its comparison with a rubber bearing. *Tribol Int* 82 (2015); 153–161.
- [13] Hryniewicz P, Wodtke M, Olszewski A, Rzakowski R. Structural properties of foil bearings: aclosed-form solution validated with finite element analysis. *Tribol Trans* 2009; 52: 435–46.
- [14] Łubiński J, Druet K, Olszewski A., Neyman A, Sikora J. Multi rig screening test for thin ceramic coatings in bio-tribological applications. *Journal of Biomechanics* 1 2010, 67-76.
- [15] Litwin W, Olszewski A. Water-lubricated sintered bronze journal bearings—theoretical and experimental research. *Tribol Trans* 2012; 57: 122–44.
- [16] Cui G., Bi Q., Zhu S., Yang J. Liu W. Tribological properties of bronze–graphite composites under sea water condition. *Tribol Int* 53(2012), 76–86
- [17] Wang N, Meng Q, Pengpeng W, Geng T, Youan X. Experimental research on film pressure distribution of water-lubricated rubber bearing with multiaxial grooves” *J Fluids Eng*, August 2013, 135, 084501-1–084501-6.
- [18] Wang Y, Shi X,Zhang L. Experimental and numerical study on water-lubricated rubber bearings. *Ind Lubr Tribol* 2014; 66(2): 282–8.
- [19] Xijin H., Jiayu W., Juanjuan Z., Wen Ji L. Study on tribological behavior of water lubricated bearings. *Journal of Advanced Manufacturing Systems* 2008, Vol. 7, No. 1, 115–121.
- [20] Dong C., Yuan C., LiU Z., Yan X. Study on fatigue life evaluation of water lubricated rubber stern tube bearing. *Prognostics & System Health Management Conference – Shenzhen* 2011.
- [21] Ginzburg B M, Tochil’nikov D G, Bakhareva V E, Anisimov A V,Kireenko O F. Polymeric materials for water-lubricated plain bearings. *Russ J Appl Chem* 2006; 79(5): 695–706.
- [22] Nisaka H, Harano Maizawa K. Development on ceramics application to water turbine bearings. *Turbomachinery* 2004; 32: 681–6.
- [23] Jahanmir S, Ozmen Y, Ives L K. Water lubrication of silicon nitride in sliding. *Tribol Lett* 2004; 17(3): 409–17.
- [24] Li J.F., Huang J.Q., Tan S.H., Cheng Z.M., Ding C.X. Tribological properties of silicon carbide under water-lubricated sliding. *Wear* 1998, 218 pp.167-171.
- [25] Jia J., Chen J., Zhou H., Wang J., Zhou H. Friction and wear properties of bronze–graphite composite under water lubrication. *Tribol Int* 2004, 37, 423–429.
- [26] Litwin W. Influence of surface roughness topography on properties of water-lubricated polymer bearings - experimental research. *Tribol Trans* 2011, 54,351-361.
- [27] Gao G, Yin D, Zhang X. Numerical analysis of plain journal bearing under hydrodynamic lubrication by water. *Tribol Int* 2014; 75:31–8.

