

## RECEIVER OF DOPPLER MULTISTATIC SYSTEM FOR MOVING TARGET DETECTION AND TRACKING

ZAWISZA JACEK OSTROWSKI

Gdansk University of Technology  
Faculty of Electronics, Telecommunications and Informatics  
Department of Marine Electronic Systems  
Gabriela Narutowicza 11/12, 80-233 Gdańsk  
zawost@eti.pg.gda.pl

*The article presents a method for solving major structural problems that occur in the receiver used in the multistatic Doppler system, aimed at determination of the trajectory and velocity of a moving target. In the system two transmitters emit acoustic continuous sinusoidal waves at different frequencies. The signals, scattered from a moving target are received by four hydrophones. Beside of the echoes, much larger signals coming directly from transmitters are recorded. It has been proved that in the presence of the direct high-amplitude signal, using currently available A/D converters, there is no possibility to detect the Doppler shift of small signals. The proposed approach is based on the homodyne frequency conversion of the received signals. Subsequently, the constant component and other unwanted products of the frequency conversion are filtered. The results of computer simulation have shown the effectiveness of the adopted design solution.*

### INTRODUCTION

The main objective of the designed system is to determine simultaneously the position and velocity of a moving target (diver or underwater vehicle) in order to protect such objects as: the power plants, dams or port quays from intruders. Although this system allows detection of the presence of a moving target, as is in the case of simple analogue systems, it could, in addition, determine its position and velocity.

The Doppler multistatic system for determining the trajectory and velocity of the target is based solely on the analysis of the Doppler shifts in signals reflected from this target, the source of which is a transmitter unit emitting an acoustic sinusoidal continuous wave. The principle of the system functioning is described in detail in [1, 2]. Additionally, the use of two operating frequencies and placing transmitting transducers at different locations makes it possible to eliminate the ambiguity in the procedure for calculating the initial position of the

target. A schematic diagram of the system including second transmitting transducer is shown in Fig. 1.

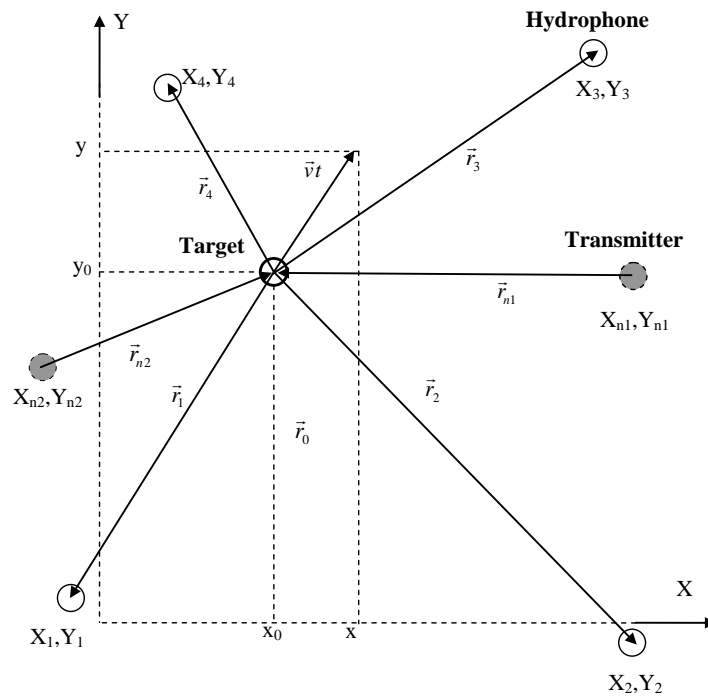

Fig. 1. Position of the transmitters (grey), hydrophones and the target under observation in a body of water.

Since the target is also able to change its position in the proximity of the transmitters and hydrophones, the spectrum of the Doppler effect is not a single line, but a broadening formation even within a short time of observation. As shown in [2], particular spectral lines of the Doppler shift correspond to temporary location of the target, wherein the extreme right-outer spectral line represents the initial position of the target ( $x_0, y_0$ ) in the analysed time interval (Fig. 2).

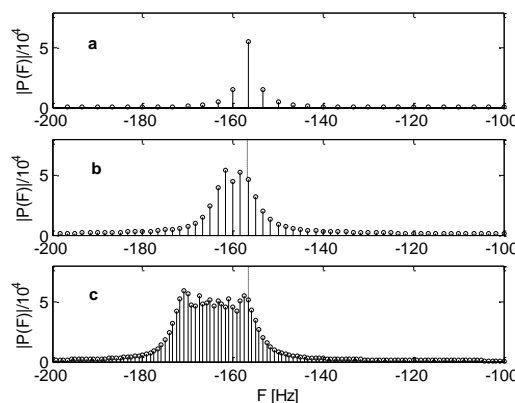

Fig. 2. Change in Doppler shift spectrum for different observation times (a:  $t=0.3$  s, b:  $t=0.6$  s, c:  $t=1.2$  s).

One of the issues in the designed system is to separate from signals received by hydrophones the Doppler shifts occurring in echo signals reflected from the moving target.

Application of a continuous wave produces the effect that the ratio of echo signal values to the values of direct signals emitted by transmitting transducers is very low. Therefore, it is necessary to design the receiver, which enables effective detection of echo signals. In this paper, the main principles of design and operation of such a receiver is presented.

## 1. SYSTEM MODEL

The model of the system consists of an underwater facility and a shore-based facility (Fig. 3). The underwater facility is composed of two transmitting transducers Tr 1 and Tr 2, and four hydrophones with preamplifiers, marked in the figure as Hyd 1 ÷ Hyd 4. The deck-based facility consists of two transmitters with two signal generators, a multi-channel receiver, a 16-channel A/D converter, and a computer.

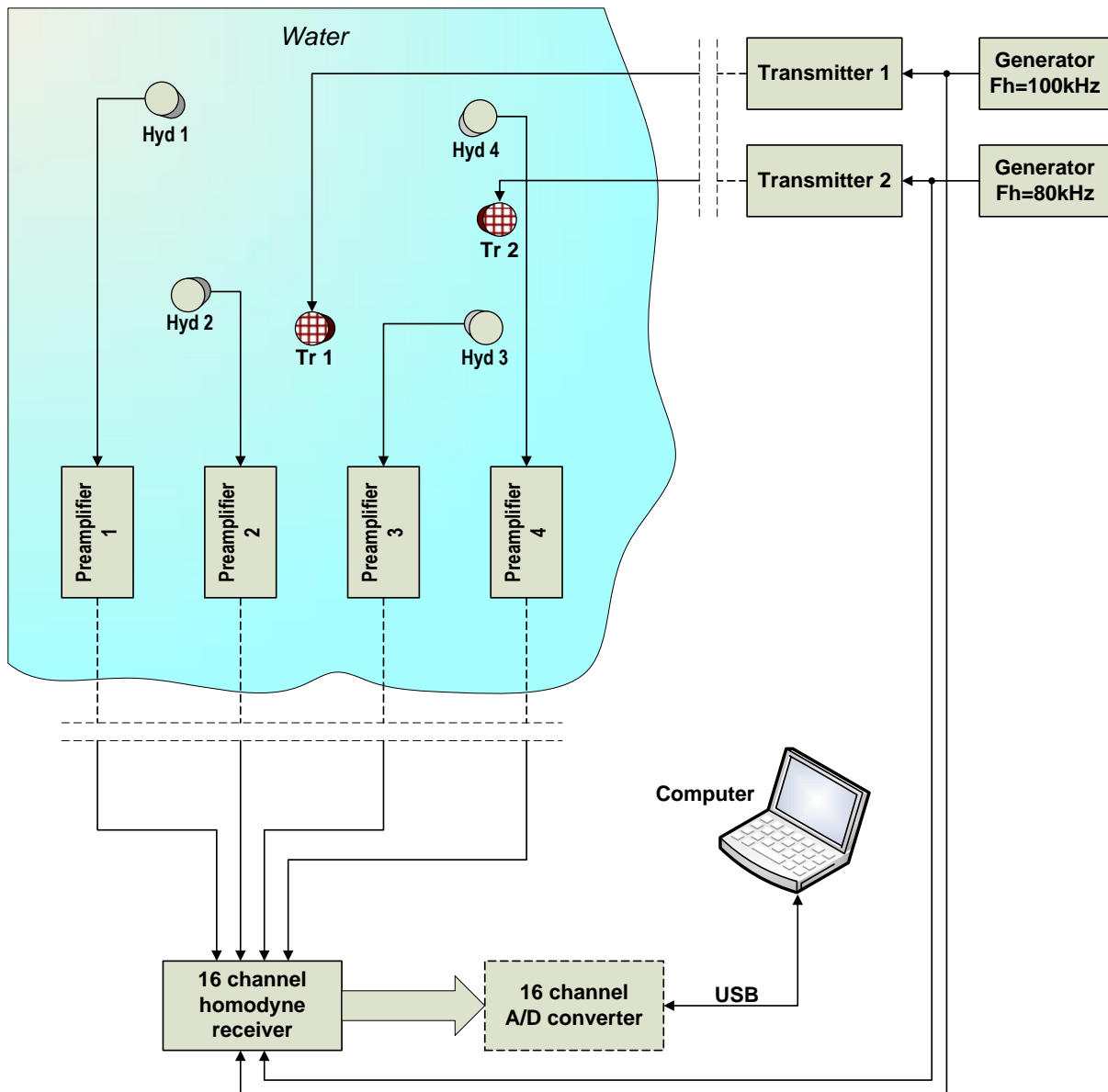

Fig. 3. Block diagram of the system model.

The signal generators produce continuous sinusoidal waves at frequencies of 100 kHz (transmitter 1) and 80 kHz (transmitter 2), which are gained by the power amplifiers and transmitted over insulated cables to two transmitting transducers (Tr 1 and Tr 2, respectively). Simultaneously, sinusoidal signals from generators are sent to the receiver, wherein the frequency conversion of amplified signals received by hydrophones is carried out.

Each of the hydrophones is connected to the preamplifier ensuring initial gain of electrical signals from hydrophone, and filtering out noise coming mainly from the power network, as well as matching the hydrophone impedance to the impedance of the connecting cable.

Another part of the system is a multi-channel homodyne receiver that means a receiver with frequency conversion realized by multiplying the received signals by corresponding signals at the transmission frequency. After amplification, homodyne processing and band-pass filtering - in the receiver, a 16-channel analog-to-digital converter shifts signals from receiving channels into digital form and via a USB interface transmits them to a computer, where they are saved as files in mass storage. The collected data are then processed off-line in the Matlab environment.

## 2. ECHO SIGNAL AND DIRECT SIGNAL

Applying a continuous wave in the system makes it impossible to carry out the separation process at the time of emission of direct signals and the receiving of echo signals, simultaneously, as it can be performed in impulse systems [3]. As a result, the ratio between the received echo signal with Doppler shift (needed for detection) and the direct signal is very small. Figure 4 presents four different situations of positioning the moving target on a square area with dimensions of 100 by 100 meters. The analysis indicated below was performed for a single transmitter located midway between the two hydrophones. Differences between the echo signal transmission losses ( $TL_E$ ) regarding the omnidirectional target's strength ( $TS$ ) and direct signal transmission losses ( $TL_D$ ) were computed [4] by employing the following formulas:

- for direct signal:

$$TL_D = 20 \log \frac{R_b}{R_1} + \alpha R_b \approx 20 \log \frac{R_b}{R_1}$$

- for echo signal:

$$TL_E = 20 \log \frac{R_{nc} R_{ch}}{R_1^2} + \alpha (R_{nc} + R_{ch}) \approx 20 \log \frac{R_{nc} R_{ch}}{R_1^2}$$

where  $R_b$  is the distance between the transmitting transducer and the hydrophone,  $R_{nc}$  is the distance from the transmitting transducer to the target,  $R_{ch}$  is the distance between the target and hydrophone,  $R_1 = 1$  m, and  $\alpha$  is a logarithmic coefficient of acoustic wave attenuation in water [dB/m].

Due to the small value of the coefficient  $\alpha$  in fresh water and small propagation distance, it has been omitted in further calculations. Thus, the difference in the value of the echo signal and the direct signal is:

$$\Delta TL = (TL_E - TS) - TL_D = TL_R - TL_D$$

where  $TS$  - strength of the target (for hydroacoustic target of the Department of Marine Electronic Systems, it was estimated as  $TS = -30$  dB).

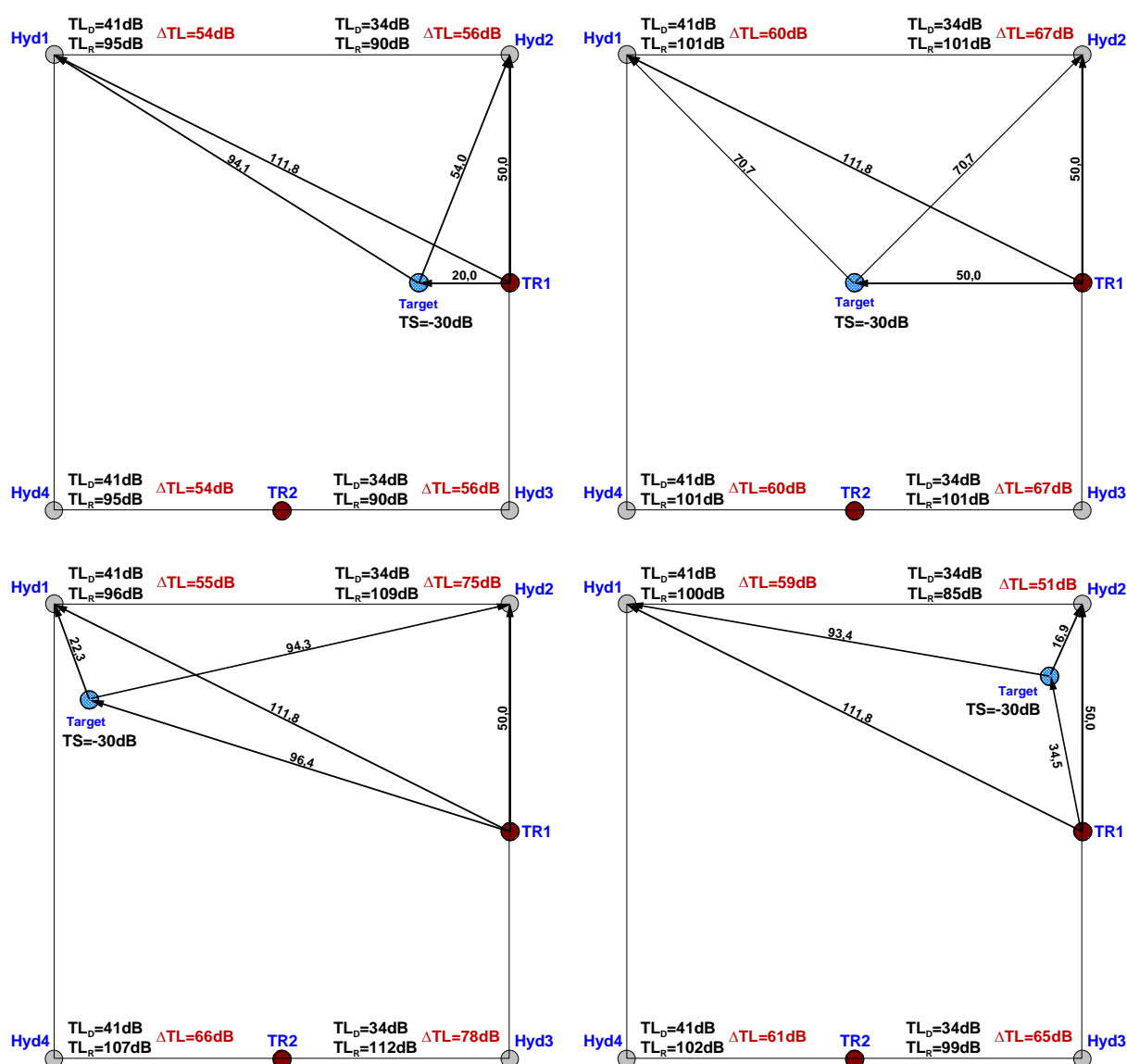

Fig. 4. Differences between echo signal transmission losses and direct signal transmission losses at various positions of the target under water.

Figure 4 indicates that the value of  $\Delta TL$  is within the limits of  $50 \div 80$  dB, which means that the amplitude of the echo signal with Doppler shift can be up to 80 dB lower than the amplitude of the direct signal received by the hydrophone. This raises the question of whether sampling is possible to be performed with good resolution of a small signal with Doppler shift in the presence of a large direct signal. The answer to this question gives an analysis of available A/C converter parameters. For example, relevant parameters of the two 24-bit Sigma-Delta A/C converters receive following values:

- with the greatest dynamics: AD7714: TR = 1 kSPS, SNR = 137 dB
- the fastest one: AD7763: TR = 625 kSPS, SNR = 107 dB

The AD7714 converter does not satisfy the processing rate (TR), since a model for the proposed system should be at least two hundred thousand samples per second (200 kSPS). For the other converter, despite its being fast enough, its dynamics of performance (SNR) of 107 dB. Therefore, the echo signal can be sampled with dynamics of 27 dB which results in a completely insufficient resolution of 4 bits.

### 3. HOMODYNE RECEIVER

Considerations described above indicate that such solutions should be sought to enable reduction of the direct signal level. Such a solution, shown in the block diagram (Fig. 5), is the use of frequency conversion of the signal received in the form of a quadrature detection with a homodyne multiplier, subsequently filtering out the constant component and other unwanted frequency conversion products.

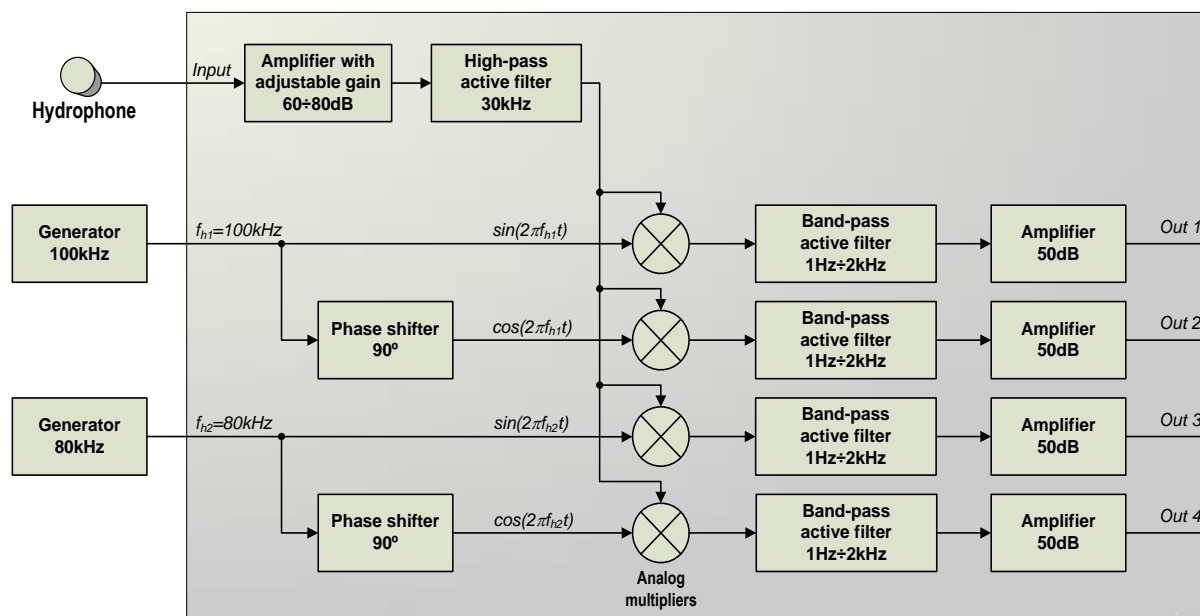

Fig. 5. Block diagram of a single channel of the receiver.

The receiver consists of four identical channels, each of which comprises a high frequency amplifier with adjustable gain and a high-pass filter (receiving channel), four analog multipliers, and four active band-pass filters with a gain of 50 dB. In addition, common to all channels are phase shifters providing two quadrature multipliers.

Gain control is chosen to maximize the usage of dynamics at the receiving channel before the process of multiplication. For a given geometrical orientation of the testing area, the gain is adjusted in such a way that the sum of direct signals received by individual hydrophones does not cause overloading of the whole receiver channel.

Signals from each receiving channel come to four analog multipliers. These signals are subject to homodyne multiplying with two signals that simultaneously drive the transmitting transducers. The system with homodyne multiplying causes the frequency of the direct signal coming from a given transmitting channel to shift to zero, and from the echo signal is separated a signal with the desired frequency equal to the Doppler shift. Whereas, multiplying the signals from the receiving channel by the sine and cosine components of a specified transmission signal allows for restoring the sign of the Doppler shift in further processing by using the complex Fourier transform of a signal after analog-to-digital conversion.

Band-pass filtering after analog multiplication is intended to reduce the constant component relating to the direct signal and to remove undesirable spectral components derived from the other frequency in which the system operates.

The impact of the above-mentioned analog operations on the spectrum of the amplified signal from the hydrophone are illustrated in further graphs generated by the programme simulating operation of the receiver systems based on the schematic diagram. Fig. 6 indicates the signal spectrum of the receiving channel for a gain of  $G = 60$  dB before multiplication.

This spectrum consists of direct signal components ( $F_1 = 100 \text{ kHz}$  and  $F_2 = 80 \text{ kHz}$ ) and their corresponding components of echo signals with the Doppler effect ( $180 \text{ Hz}$  and  $-300 \text{ Hz}$ , respectively) with a lower amplitude - for instance of  $40 \text{ dB}$  - than the amplitude of the direct signals. Figures 7 and 8 represent spectra of the receiving channel signal after multiplying by the transmitting signals  $F_h=100 \text{ kHz}$  and  $F_h=80 \text{ kHz}$ , respectively, for wider (Chart A) and narrower (Chart B) frequency range.

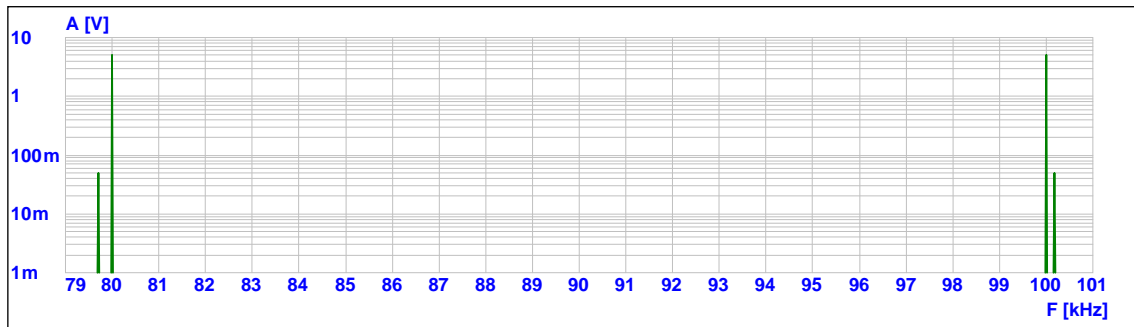

Fig. 6. The spectrum of hydrophone signal being amplified for  $G=60\text{dB}$ :

$$F_1=100\text{kHz}, U_{F_1}=5\text{mV}, U_{F_1+180\text{Hz}}=0.05\text{mV}, \\ F_2=80\text{kHz}, U_{F_2}=5\text{mV}, U_{F_2-300\text{Hz}}=0.05\text{mV}.$$

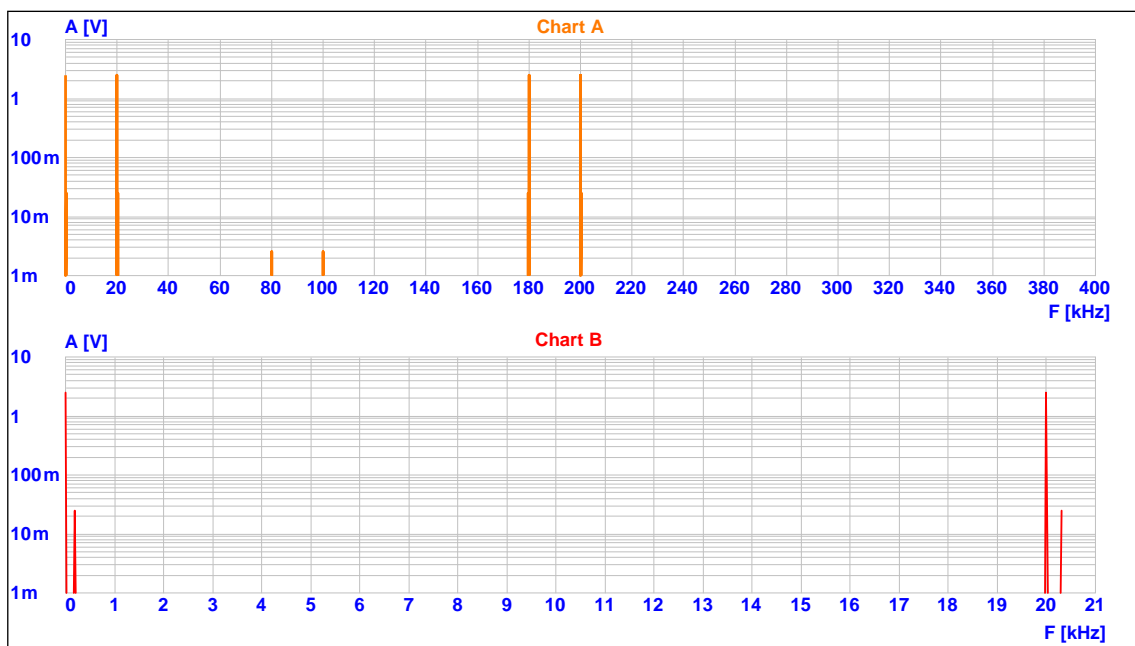

Fig. 7. The spectrum of the hydrophone signal being amplified after multiplication with the signal of  $100\text{kHz}$  for  $G = 60\text{dB}$ .

As previously mentioned, homodyne multiplying implied that the spectrum line corresponding to the frequency of the direct signal from a given transmitting channel ( $F_1 = 100 \text{ kHz}$  in Fig. 7 and  $F_2 = 80 \text{ kHz}$  in Fig. 8) has shifted to zero, and from the echo signal has been obtained a signal with a frequency of the desired Doppler shift. In addition, spectrum lines corresponding to the other operating frequency ( $F_2 = 80 \text{ kHz}$  in Fig. 7, and  $F_1 = 100 \text{ kHz}$  in Fig. 8) with a maximum Doppler shift were moved toward the frequency  $F_1-F_2 = 20 \text{ kHz}$ . It can be observed (Fig. 8) that information on the Doppler shift sign was lost; however, due to the fact that quadrature multiplication was introduced, the sign will be restored in further complex FFT-based signal processing.

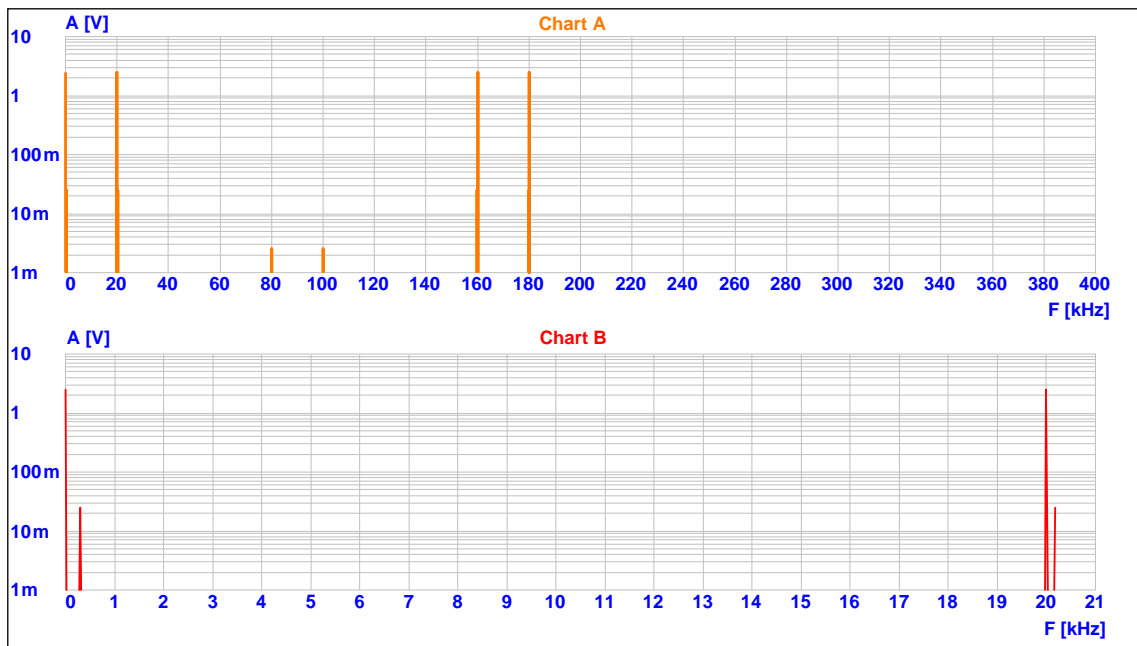

Fig. 8. The spectrum of the hydrophone signal being amplified after multiplication with the signal of 80kHz for  $G = 60\text{dB}$ .

In order to determine the trajectory and velocity of a moving target, a spectrum line corresponding to the Doppler shift frequency should be distinguished from the spectrum of the signal after multiplication. For this purpose, an active band-pass filter (Fig. 9) was applied with a gain of  $G_2 = 50\text{ dB}$ , in a band of  $B = 1 \div 1600\text{ Hz}$ , and a filter slope of  $60\text{ dB per decade}$  from both ends of the band.

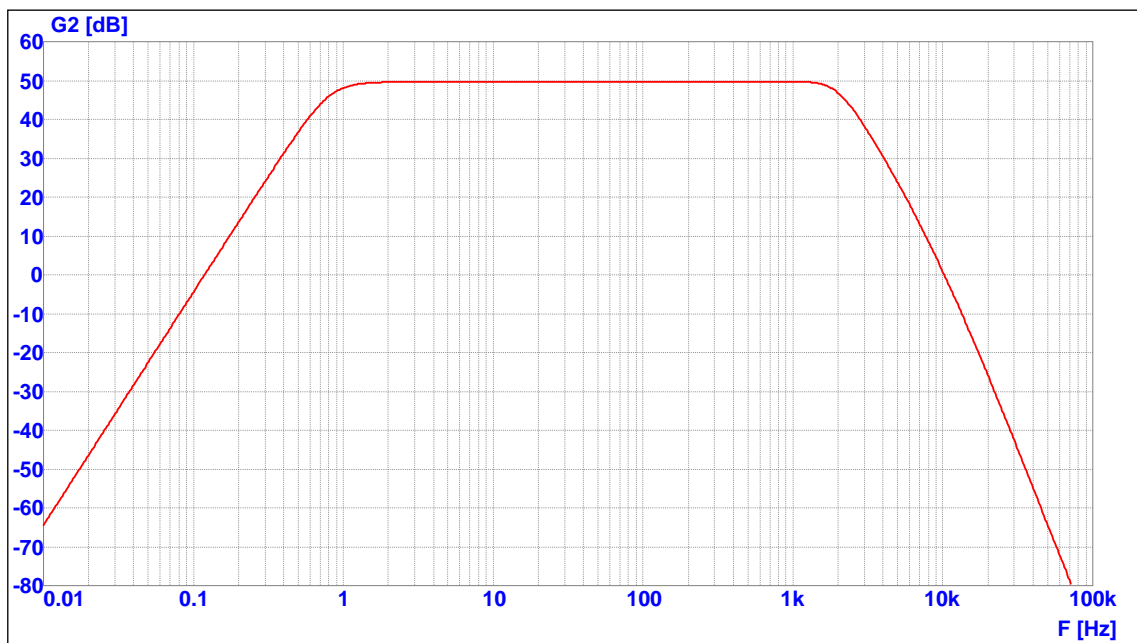

Fig. 9. Frequency characteristics of the band-pass filter  $G_2(F)$ .

After band-pass filtration, the spectrum of the output signal is obtained (Fig. 10) with strongly reduced zero-sequence and undesirable spectral components derived from the other frequency of the system operation.



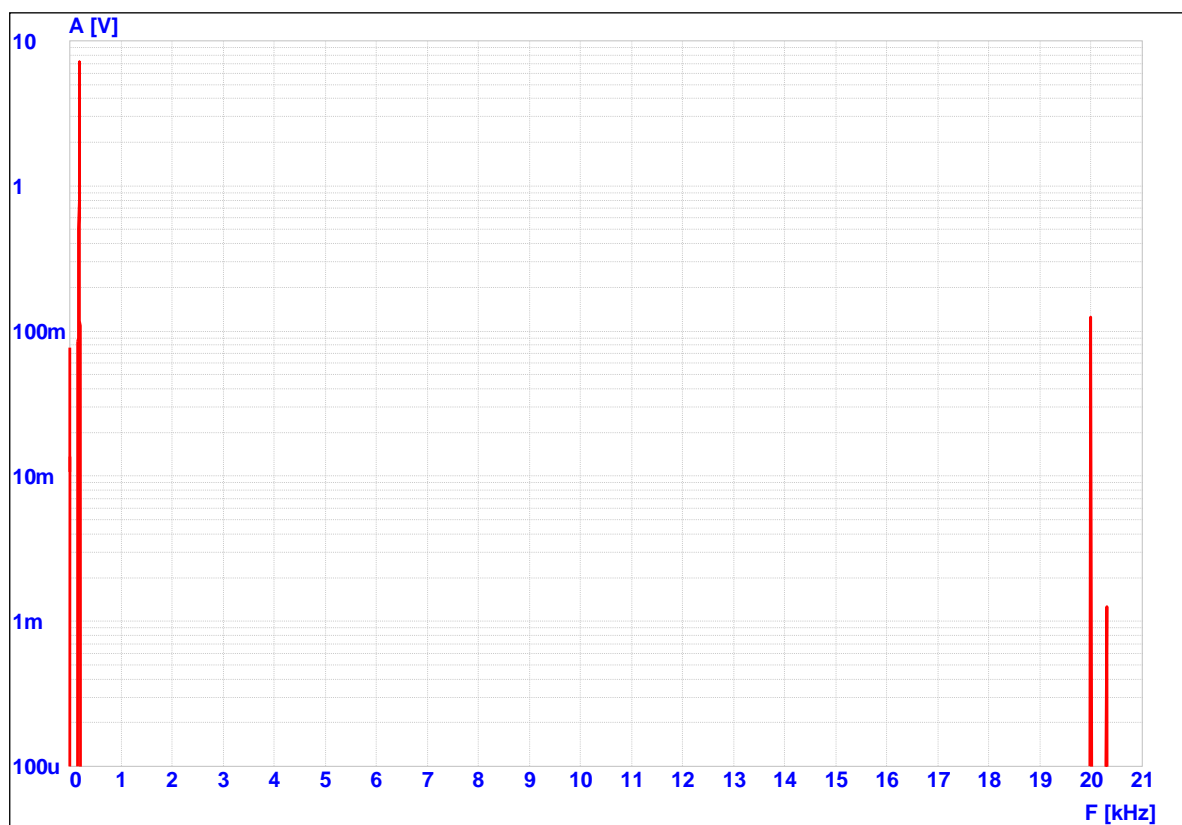

Fig. 10. The spectrum of Doppler shift signal after band-pass filtration and amplification for  $G = 60\text{dB}$ ,  $F_h = 100\text{kHz}$  and gain of the filter  $G_2 = 50\text{dB}$ .

Figure 10 shows the situation when the amplitude of echo signals with the Doppler shift is about 40 dB lower than the amplitude of corresponding direct signals. In fact, the value of this difference can receive up to 80 dB for a testing area of 100 x 100 meters (Fig. 4). Thus, the amplitude value of an undesirable spectral line derived from the other operating frequency can exceed the value of spectral line corresponding to the amplitude of the desired Doppler shift, despite the fact that the sharp band-pass filter was applied. In order not to complicate the structure of the receiver by applying higher-order filters, it is possible to filter out these undesirable signals with digital methods after application of the FFT. However, this requires applying a higher sampling frequency (in this case 50 kHz sampling frequency should be used) in the analog-to-digital conversion process.

#### 4. THE EFFECT OF OVERLOAD ON THE SPECTRUM OF A HYDROPHONE SIGNAL BEING AMPLIFIED

Current analysis of the signal spectrum in various systems of receiver assume operation in linear range of the receiving channel.

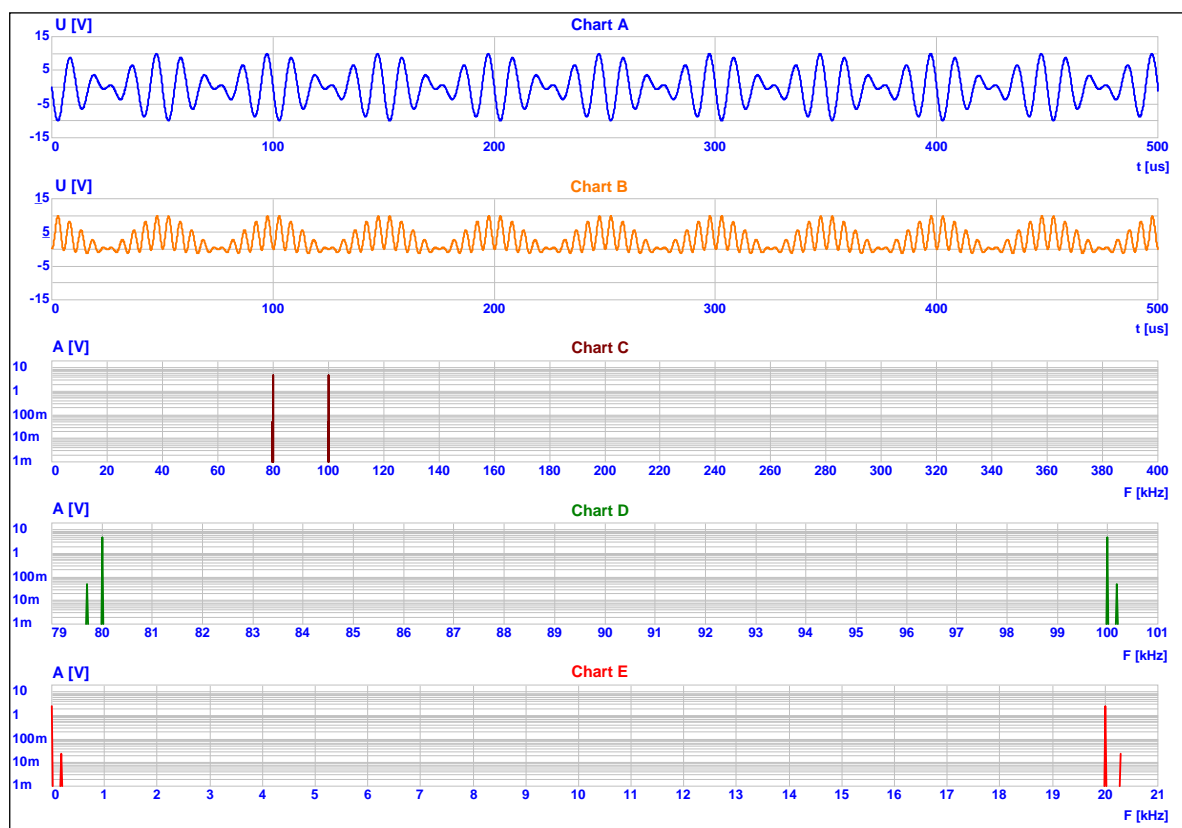

Fig. 11. Time domain and spectra of signals before and after multiplying for the max. possible amplitude of the output signal;  $G = 60\text{dB}$  and  $F_h = 100\text{kHz}$ .

Figure 11 shows that the time domain representation of the hydrophone signal gained 60 dB, before (Chart A) and after (Chart B) analogue multiplication, showing as well, its spectrum before multiplication (Chart C for a wider frequency range, and Chart D for a narrower frequency range) and after multiplication (Chart E). Electrical signal parameters at hydrophone output are the same as the parameters of the signal whose spectrum after amplification is shown in Fig. 6. After increasing the gain of the receiving channel by 15 dB, the signal is distorted, as shown in Figure 12. In such a case, in the signal spectrum - already before the analogue multiplication is performed - additional spectral lines occur. After the multiplication there are even more spectral lines, as the result of summing and subtraction of all the harmonics of the frequency components included in the distorted signal. In particular, spectral lines of the Doppler shift from a system operating frequency occur at the second one, and vice versa (Charts D and E in Fig. 12 and Charts B and C in Fig. 13). After homodyne multiplying, it is not possible to eliminate such undesirable lines by using band-pass filtering. This leads to the conclusion that in such case, it is inadvisable to overload the receiver channel.

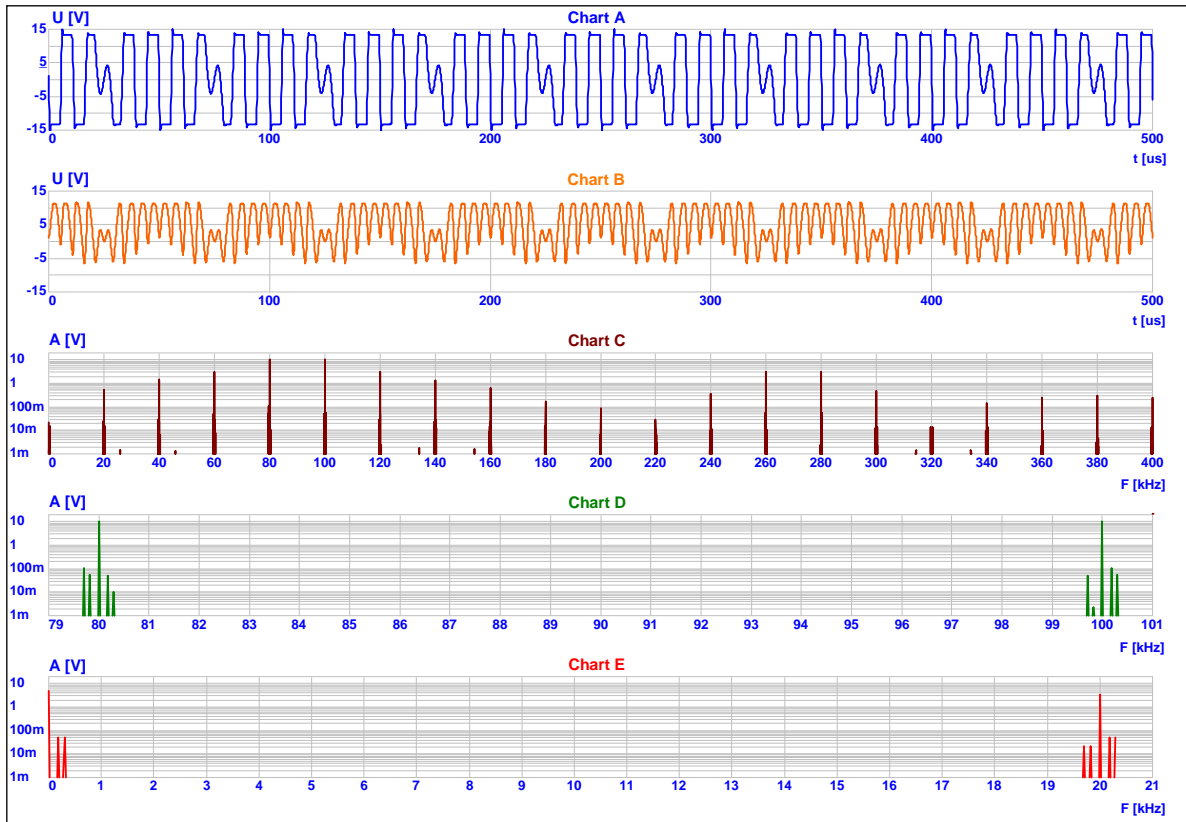

Fig. 12. Time domain and spectra of signals before and after multiplying for slightly overloaded receiver channel;  $G = 75\text{dB}$  and  $F_h = 100\text{kHz}$ .

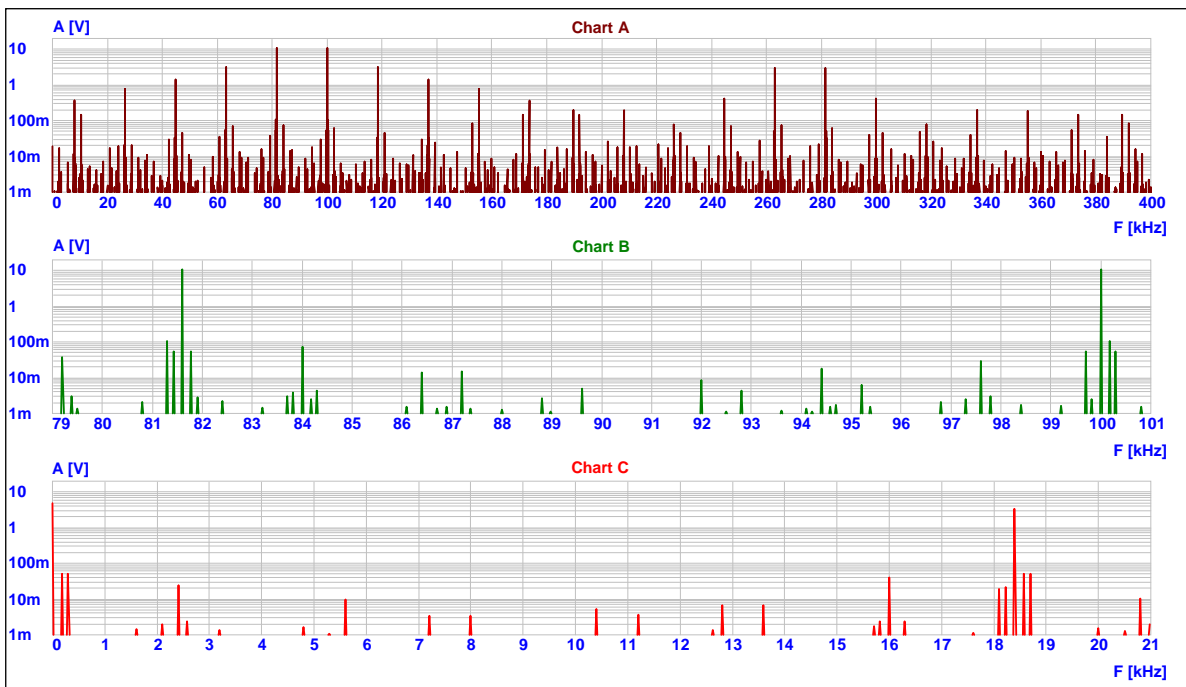

Fig. 13. The spectrum of overloaded signal from hydrophone for different interval between the system operating frequencies (18.4 kHz) for  $G = 75\text{dB}$  and  $F_h = 100\text{ kHz}$ :  
 $F_1=100\text{ kHz}$ ,  $U_{F_1}=5\text{mV}$ ,  $U_{F_1+180\text{Hz}}=0.05\text{mV}$ ,  $F_2=81.6\text{kHz}$ ,  $U_{F_2}=5\text{mV}$ ,  $U_{F_2-300\text{Hz}}=0.05\text{mV}$ .

Figure 13 shows the case of overloading the receiving channel for a different interval between system operating frequencies. Since the interval is not a subharmonic of any transmitting signals, in the spectrum of the excessively gained hydrophone signal there appear many more lines that are sums and differences of all the harmonics of the frequency components of this signal.

## 5. CONCLUSION

Adjusting the signal level of the Doppler shift to the processing range of available A/C converters can be achieved by proper design of the receiver:

- applying homodyne and quadrature multiplication of signals received by four hydrophones with relevant signals of transmitting frequencies,
- band-pass filtering of the result of a multiplication in order to remove the constant component and undesired spectral components derived from the other operating frequency.

Furthermore, in order to ensure proper extraction of Doppler shifts contained in reflected echo signals from a moving target, overloading the receiving channel is not allowed. The use of the proposed solution in design of the system being developed allows for its operation in accordance with the assumed objectives.

## REFERENCES

- [1] R. Salamon, J. Marszal, Doppler Estimation Method for Moving Target Location, *Hydroacoustics*, Vol. 13, pages 225-234, 2010.
- [2] Z. J. Ostrowski, The Doppler effect in a bistatic system for determining the position of moving targets, *Hydroacoustics*, Vol. 17, pages 225-234, 2014.
- [3] J. Marszal, R. Salamon, Multistatic Doppler Sonar for Man-Made Lakes and Water-Power Plants Antiterroristic Protection, *Proc. of the 10th European Conference on Underwater Acoustic*, pages 1333-1339, Istanbul 2010.
- [4] R. Salamon, *Systemy hydrolokacyjne*, Gdańskie Towarzystwo Naukowe, 2006.