

Novel condition monitoring of induction motor bearings via motor current signature analysis

Tomasz Ciszewski, Ariel Dzwonkowski and Leon Swedrowski,
Gdansk University of Technology
Gdansk, 80-233 Poland
Telephone: +48 58 347 1284
leon.swedrowski@pg.gda.pl

Len Gelman
Cranfield University
Cranfield, MK43 0AL, United Kingdom

Abstract

The paper authors are researching the assessment of bearing conditions in induction motors. The methods developed by the authors are based on measurements and analysis of the motor supply current, which is particularly attractive in the absence of access to the engine. The article provides an overview of selected methods of induction motor bearings diagnostic based on Motor Current Signature Analysis (MCSA). However, there is no solution to date which credibility allows for industrial application. The main problem is the high ratio of disturbance components compared to the useful diagnostic components in the motor current. The author team has developed a methodology which enables introduction of various damage to bearings and also built a test stand enabling a wide range of engine tests with damaged bearings. This has provided the opportunity to compare the results of a large number of damaged bearings in a controlled manner, and also to compare different diagnostic methods. The article presents results of two new studies performed on this test stand, obtained on the basis of instantaneous power measurements and statistical method of signal analysis that have been improved by the authors. Preliminary studies confirm the advantages of these methods. The presented concept has the potential for industry implementation.

1. The overview of known methods

1.1 Signal filtration

A number of studies have used the Wiener filter and further processing of the noise reduced signal. This method will be further discussed by the example of the "Incipient Bearing Fault Detection via Stator Current Noise Cancellation Using Wiener Filter" ⁽¹⁾
In the motor current spectrum there is a fixed set of components that do not change over time. It consists of harmonic currents, current components associated with eccentricity, coronal harmonic, harmonics related to saturation of the magnetic circuit and others. This set is independent of the state of the bearings. From the point of view of bearing testing, these are interference and should be removed. With equal engine load, these components are the same and can be predicted using the motor current information.

In the initial design phase, measurements are made on the undamaged engine under various operating conditions. The results obtained are fed to the Wiener filter. Further, during the diagnostic tests, all interference components are removed during Wiener filter parameters estimation. After filtering out the entire spectrum of current, existing in the engine without damage, only new components remain resulting from damage to the engine under test. These new components produce an error rate based on the effective current remaining after filtration. In this method one does not look for the components in the current spectrum, which are related to different types of bearing damage, so one does not need to know the bearing parameters.

Filtration of interference in the stator current by the Wiener filter is effective and significantly improves the spectral differentiation of the undamaged engine from the defective one. The proposed method does not, however, determine the type of damage that affects the bearing efficiency forecasting time. It seems that the Wiener filter can be used as the first component of a more complex signal processing circuit.

1.2 Impact of bearing damage on the efficiency of induction motors

The authors of the method ⁽²⁾ discussed in this paragraph claim that a developing damage of the engine results in a decrease in its efficiency, and therefore energy losses. That is why, engine diagnostics is designed not only to prevent unexpected accidents, but also to avoid energy losses during engine operation with developing damage. However, fault detection only by measurement of efficiency has the disadvantage, that it does not provide information on the type of damage to the bearing. Therefore, for a complete diagnosis, another method must be used in parallel. In the study ⁽²⁾, the stator current analysis was chosen as the second method. All tested bearing defects have had an effect on engine efficiency: the spread of this efficiency falls to 4% under low load conditions and about 1.5% at full load in case of more serious damage (external ring fracture and deformation of the cart).

In the assessment of this article's authors, the measurement of efficiency does not give reliable diagnostic information about the state of the engine, and especially the occurrence of a particular damage. Moreover, it is necessary to use additional devices for speed measurement and load torque, which are expensive.

1.3 Detection of bearing defects using the Park vector

The motor current may be represented by Park vector ⁽³⁾, which is a function of three phase currents (i_a, i_b, i_c) and has two components: i_d and i_q :

$$\begin{aligned} i_d &= \sqrt{\frac{2}{3}}i_a - \frac{1}{\sqrt{6}}i_b - \frac{1}{\sqrt{6}}i_c \\ i_q &= \frac{1}{\sqrt{2}}i_b - \frac{1}{\sqrt{2}}i_c \end{aligned} \quad (1)$$

In the ideal case, when there are only basic harmonics in the currents, the Park vector has a constant value of the module. Then the graph of the function $i_q = f(i_d)$ (1) is in the form of a circle. In case of damage in the motor, the currents are deformed and the above assumptions are not met. The function graph $i_q = f(i_d)$ is no longer circular. Using the change in the shape of these curves for diagnostics is problematic, because assigning specific changes to the image for each type of damage is ambiguous, and the appearance

of harmonic in power or other types of disturbances also changes the form of dependence $i_q = f(i_d)$. However, because the Park vector still contains information about engine failure, another method was proposed (rather than studying the dependence $i_q = f(i_d)$) for bearing diagnostics. This method is based on studying the spectrum of the Park vector module ⁽³⁾.

The analysis of the spectrum of the Park vector module results in two important information: in the analyzed spectrum there is no component with the fundamental frequency of the harmonic network, while the amplitudes of the diagnostic components are enlarged $3i_{dr}$ times.

Both of these advantages, resulting from dependence (1), theoretically allow to significantly improve the ability to identify diagnostic components against background noise compared to direct current spectral analysis. This can allow damage detection in the early stages of development.

However, in practice, due to the inadequate parameters of the power supply and the engine, the actual benefits are much lower, with the method itself generating additional sources of interference. This creates problems for practical applications.

1.4 Bearing diagnostics based on the instantaneous power factor

The authors of the paper ⁽⁴⁾ state that over the past decade the major problem faced by the industry was fault detection and diagnostics of asynchronous motors. Currently, the main impact of the search is to analyze the various parameters related to the motor current.

This study proves that early defects affect the electromagnetic moment and thus transfer themselves to electrical currents. The authors further state that, in the event of damage, the torque oscillations of the torque produce oscillations of the electrical power factor.

A new diagnostic method has been introduced that defines the instantaneous power factor (IPF) as a diagnostic parameter. Thus, the goal becomes to determine the value of the phase angle, which is associated with bearing defect information. The whole study was conducted on only one damaged bearing, which does not allow for comparisons with other damage.

It has not been explained, how the method works on other types of damage in the machine - does it interfere with the study of the bearings?

From the theoretical point of view, the IPF measurement method is similar to the instantaneous power measurement (IP) method. The IP method application is described one of the following points.

2. Diagnosis of bearing damage in induction motors by instantaneous power analysis

2.1 Description of the test stand

For research on bearing diagnostics, a measuring stand was constructed at Gdansk University of Technology (GUT), which consists of a test engine, magnetic clutch, laser system for accurate alignment of shafts and vibroacoustic silencers, whose purpose is to isolate the tested machines from ambient vibration. Similar silencers are also located



under the base on which the weight is located. The laboratory stand allows measurements of up to 5.0 kW⁽⁵⁾ induction machines.

For measuring currents and voltages, a measuring circuit consisting of a high-class shunt with a resistance of 0.1 Ω and a resistive voltage divider were used (figure 1).

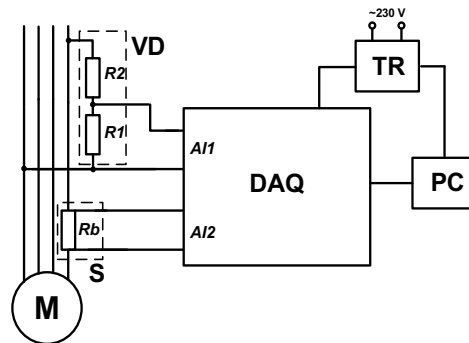

Figure 1. Block diagram of the test stand: M – tested machine, S – shunt, VD – voltage divider, KP – measurement cassette, DAQ – data acquisition card, PC – PC computer with software, TR – separating transformer

The voltage divider consists of two resistors with resistances of 20 k Ω and 10 M Ω . The shunt accuracy class is 0.02 and the accuracy class of the resistors used in the voltage divider is respectively 0.05 and 0.02. In order to avoid large potential differences between the input of the card, the power supply of the card and the computer, a separating transformer in the PXI test cassette power supply and PC circuit is used.

A National Instruments measuring system cooperates with the laboratory stand. This system is a NI PXI 1031 cassette in which the PXI 4462 measuring card is installed. The PXI system was used to measure the instantaneous currents and voltages of the test machines. The measured instantaneous values of currents and voltages were sent to the computer where they were analyzed to determine the spectral components for use in bearing diagnostics.

A program developed in the LabVIEW programming environment, which enables the presentation of measurement results⁽⁶⁾, is used to visualize the read data.

2.2 Diagnosis of induction motors with damaged bearings

One method proposed by the GUT team is to analyze the momentary power signal deformation, calculated as the product of the instantaneous current and voltage values for the machine^(5,6,7). This method assumes a model of phenomena occurring in the engine, where the contact of a damaged bearing part with another bearing element causes a temporary increase in the torque and, as a consequence, the IP taken by the motor. As a result, the deformations appear as additional harmonic components of the spectrum. These components are caused by waveform distortions with frequency-specific signals for the given type of bearing damage. Thus, in the IP spectrum there are components that can be used as a diagnostic symptom based on which it is possible to assess the technical condition of bearings in induction motors.

Experimental studies were carried out on STg80X-4C motors, both with undamaged and deliberately damaged bearings. The DREAM vibration diagnostic system was used as a

comparative method ⁽⁵⁾. This device consists of an DC11 analyzer - data collector with vibration sensor and PC software. The measurement process consists of installing a vibration sensor on the examined object and recording the vibration in the collector. A series of 6204 type bearings with different depths of introduced defects were tested. For comparison, also undamaged samples were tested. Figure 2 shows the IP spectrum obtained for the undamaged motor.

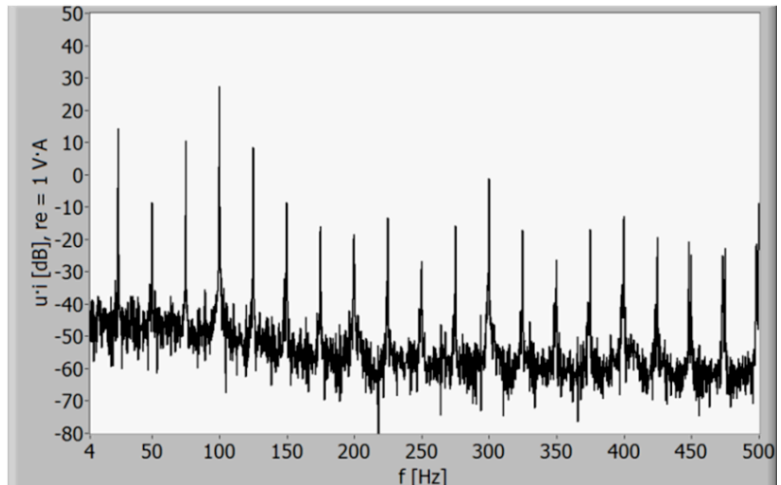

Figure 2. IP spectrum for the motor without damage (load 80% I_n) ⁽⁵⁾

All components in the spectrum shown in the figure are the result of normal machine operation and are in line with expectations. These components are related to the presence of the harmonics of the supply voltage of the motor and the frequency associated with the speed of rotation of the rotor. Also the DREAM vibration diagnostic system did not detect any damage to the bearings of the tested engine.

Figure 3 shows the IP spectrum obtained from measurements for a motor with internal bearing ring damage of medium depth at a load equal to 80% of the rated current.

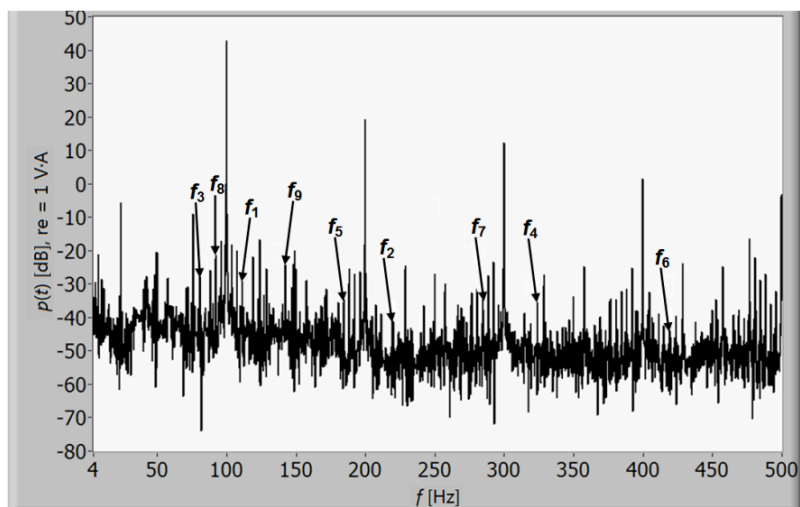

Figure 3. IP spectrum for induction motor with bearing inner race damage (load 80% I_n)

In the case of this type of bearing damage, in the IP spectrum, there is a characteristic component of the defect $f_H = 116.9$ Hz (spectral line f_1) as well as components which are the result of deformation of the IP signal for the undamaged motor, characteristic frequency signal (spectral lines $f_2, f_3, f_4, f_5, f_6, f_7$) which frequencies are 216.9 Hz, 83.1 Hz, 316.9 Hz, 183.1 Hz, 416.9 Hz and 283.1 Hz respectively. These components are combinations of frequencies respectively: $2 \cdot f + f_H, 4 \cdot f - f_H, 4 \cdot f + f_H, 6 \cdot f - f_H, 6 \cdot f + f_H, 8 \cdot f - f_H, 8 \cdot f + f_H$. Subsequent spectral lines in the IP spectrum are the products of the rotor rotational speed modulation $f_r = 23.2$ Hz with the frequency characteristic f_H (spectral lines f_8 and f_9) whose frequencies are 93.7 Hz and 140.1 Hz respectively. Diagnoses from the DREAM system have also confirmed the existence of an internal ring damage to the bearing. The system reported the frequency characteristic for this type of damage at 117.08 Hz (figure 4).

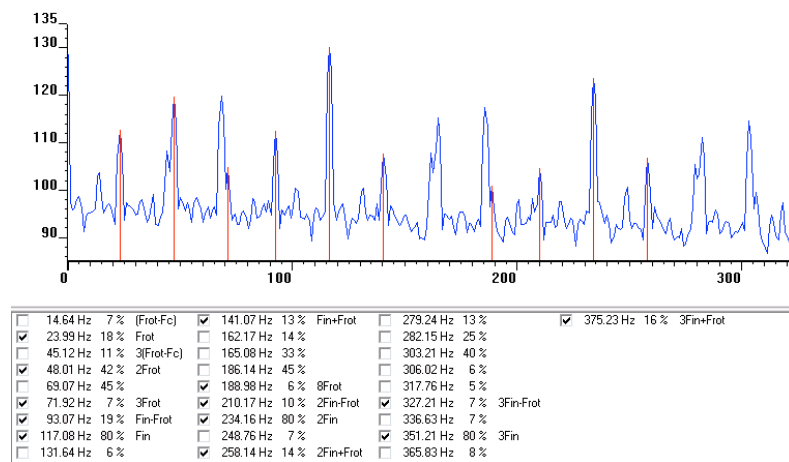

Figure 4. Vibration spectrum for induction motor with bearing inner race damage (load 80% I_n)

Other types of bearing defects were also measured. Figure 5 shows the IP spectrum for the motor with the outer ring of the bearing damaged (moderate depth damage) at a load of 80% I_n .

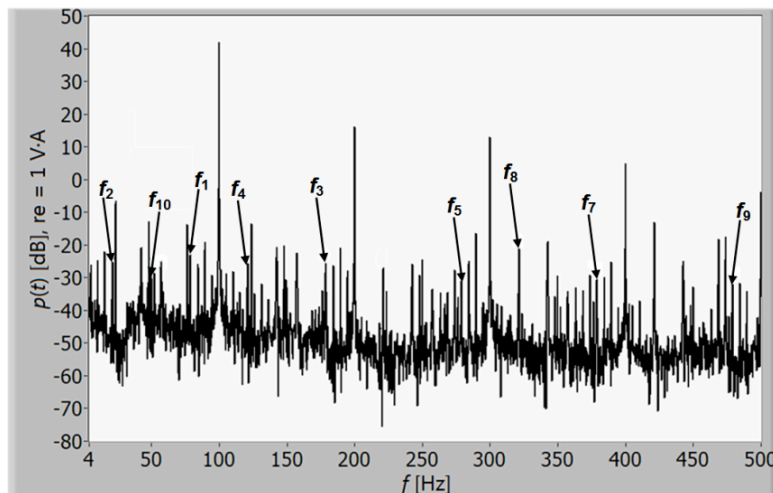

Figure 5. IP spectrum for induction motor with bearing outer ring damage (load 80% I_n)

In the instantaneous power spectrum there is a component with the frequency characteristic of the external ring $f_H = 75.8$ Hz (spectral line number f_1). In addition, the frequencies resulting from the distortion of the instantaneous signal by the characteristic frequency signal are present in the spectrum. These are spectral lines with numbers $f_2, f_4, f_3, f_6, f_5, f_8, f_7, f_9$, whose frequencies are respectively 24.2 Hz, 124.2 Hz, 175.8 Hz, 224.2 Hz, 275.8 Hz, 324.2 Hz, 375.8 Hz, 475.8 Hz. These components are combinations of frequencies respectively: $2f - f_H, 2f + f_H, 4f - f_H, 4f + f_H, 6f - f_H, 6f + f_H, 8f - f_H, 8f + f_H$, where f is the frequency of the supply voltage. In the spectrum also appears the component of frequency f_{10} , which is the result of the modulation of the component associated with the rotational speed of the rotor $f_r = 24.2$ Hz component with the characteristic frequency f_H . This component is a frequency combination $|f_r - f_H|$ and is 51.6 Hz.

The obtained results of the analysis of the IP signal were verified using the vibration diagnostic system. This system identified the damage at the outer ring of the bearing, giving the characteristic frequency for this type of damage equal to 75.75 Hz.

The obtained results of the research on real objects have confirmed that in the IP spectrum appear harmonic components related to the frequency characteristic for a particular type of bearing damage. Analysis of the results of the experimental studies confirmed that this phenomenon occurs independently of the frequency generated by the damaged bearings vibration. The results of conducted experiments on the induction motor have also confirmed the fact that in the IP spectrum there is an explicit component with the frequency of the introduced damage.

3. Normalized Triple Covariance as a IM bearings diagnostic indicator

The authors of this paper attempt to solve MCSA bearings diagnostic problem by developing a method based on the novel higher order spectral covariance^(8,9). A new signal processing method, which is proposed in reference⁽⁹⁾ and successfully applied in reference⁽⁸⁾ is the normalized triple covariance (NTC) described by equation (2). This algorithm is designed to detect common nonlinear amplitude fluctuations of three frequency components of a signal.

The first step to calculate the NTC is to cut the discrete time domain signal into segments. The next step is to perform the FFT for each time segment. Shaft rotation frequency f_r and supply grid frequency f_g were designated from the obtained spectrum for each segment. Values of these frequencies are necessary to calculate the characteristic frequencies for bearing damage. The next step is to get complex amplitude values from spectra for three characteristic frequencies in each segment. The following step is to use (2) to calculate the NTC. The last operation is to calculate mean value of NTC for three phases of motor current. Authors propose to use the value achieved this way as a diagnostic symptom which can be used for IM bearing diagnostic purpose.

$$NTC(x, f_1, f_2, f_3) = \frac{\frac{1}{n} \sum_{i=1}^n ((X_i(f_1) - E(X(f_1))) \cdot (X_i(f_2) - E(X(f_2))) \cdot \overline{(X_i(f_3) - E(X(f_3)))})}{\sqrt{\sigma^2(X(f_1)) \cdot \sigma^2(X(f_2)) \cdot \sigma^2(X(f_3))}} \quad (2)$$

where:

x – discrete time domain signal

n – number of time segments

$X_i(f_1)$ – Fourier transform coefficient from signal x for i -th time segment for frequency f_1

$E(X(f_1))$ – mean value of Fourier transform coefficients for frequency f_1 in all time segments

$\sigma^2(X(f_1))$ – variance of Fourier transform coefficients for frequency f_1 in all time segments.

For diagnostic of IM bearing damage through the MCSA, the authors assumed that 32 frequency components could be employed. Previous research ⁽¹⁰⁾ showed, that these current components, are the most sensitive for bearing damages. The proposed algorithm requires exactly three components to calculate the NTC. Previous research did not distinguish clearly which of the components are the best for use with the NTC. Therefore, the authors of this paper assume that the NTC calculated for each combination of 3 out of 32 components is a potential diagnostic feature for IM bearings diagnosis. Considering the 32 components and including the fact that switching places of the first and the second component does not affect the value of the NTC, one can get 14880 different combinations of 3 out of 32 components. The NTC calculated for different components combinations reveals different properties. Therefore, the NTC calculated for different component combinations can work better with some bearings cases but not so well for other cases. The choice of components is very important for an effective separation between damaged and undamaged cases. It is not possible to distinguish which component combination has better properties on a theoretical basis, therefore, the authors calculated the NTC for all possible components combinations. The next step was to calculate the Fisher's criterion (3), with NTCs calculated for all 14880 components combinations on a random set of bearings.

$$F = \frac{|m_1 - m_2|^2}{\sigma^2_1 + \sigma^2_2} \quad (3)$$

where:

m_1 – mean value of the NTC for undamaged bearings cases

m_2 – mean value of the NTC for damaged bearings cases

σ^2_1 – variance of the NTC for undamaged bearings cases

σ^2_2 – variance of the NTC for damaged bearings cases

The authors assumed that the separation between damaged and undamaged cases is better if the value of the Fisher's criterion is greater. Diagnostic indicator (DI) is defined as sum of 5 NTCs with the highest Fisher's criterion achieved on a random set of bearings. Rest of bearings not included in the learning set is diagnosed with DI obtained this way to validate the achieved DI. Authors set a threshold between healthy and unhealthy cases in the middle between mean DI value for damaged cases and mean DI value for undamaged cases.

All presented results, including measurements used for components selection are based on IM current supply measurements for a full load. Squirrel cage IM used for the tests was Sh 80X-4C, with the nominal power of 1.1 kW. The motor was supplied directly from 50 Hz three phase supply grid. The type of bearings installed in the motor was 6204. The experiment was performed on 10 bearings with artificially damaged outer race and 32 bearings with undamaged outer race. At the same time as the IM current was measured, another measurement was performed in each case with the DREAM vibration diagnostic system. Results obtained from this system (percentage damage) and description of introduced damages are listed in table 1.

Table 1. Bearings used for experiment

Bearing number	Introduced outer race damage	DREAM result
1.	pit damage diameter=1.0 mm and depth=0.5 mm	21%
2.	pit damage diameter=1.5 mm and depth=0.7 mm	17%
3.	pit damage diameter=2.0 mm and depth=1.0 mm	80%
4.	scratch along the rolling direction length=3 mm, depth=0.5 mm, width=1 mm.	31%
5.	scratch along the rolling direction length=3 mm, depth=0.7 mm, width=1 mm.	36%
6.	scratch along the rolling direction length=3 mm, depth=1 mm, width=1 mm.	80%
7.	scratch along the rolling direction length=6 mm, depth=0.7 mm, width=1 mm.	52%
8.	scratch across the rolling direction length=3 mm, depth=0.5 mm, width=1 mm.	68%
9.	scratch across the rolling direction length=3 mm, depth=0.7 mm, width=1 mm.	80%
10.	scratch across the rolling direction length=3 mm, depth=1 mm, width=1 mm.	80%
11. to 42.	bearings with not damaged outer race	0%

The graphs (figure 6 to figure 8) contain results for all bearings including cases that were used for learning. On the presented graphs, red 'X' stands for bearings with introduced damage and blue 'O' stands for undamaged bearings. The horizontal solid line can be used as a border between healthy and unhealthy cases. Presented Fisher's criterion value in all cases was calculated for all acquired data (including bearings used for learning). DI was obtained from 3 learning sets of randomly selected bearings. In all presented graphs x-axis indicates the number of bearings according to table 1 and y-axis indicates the value of obtained DI. Above each graph there is a list of bearings included in the considered learning set.

Set 1:

Damaged: 2, 4, 5, 7, 9

Undamaged: 11, 16, 19, 20, 22, 24, 26, 27, 28, 29, 30, 32, 33, 34, 36, 38

Fisher's criterion: 2.3

The ratio of good diagnosis compared to all is:

Damaged: $4/5=80\%$; Undamaged: $14/16=88\%$; All: $18/21=86\%$

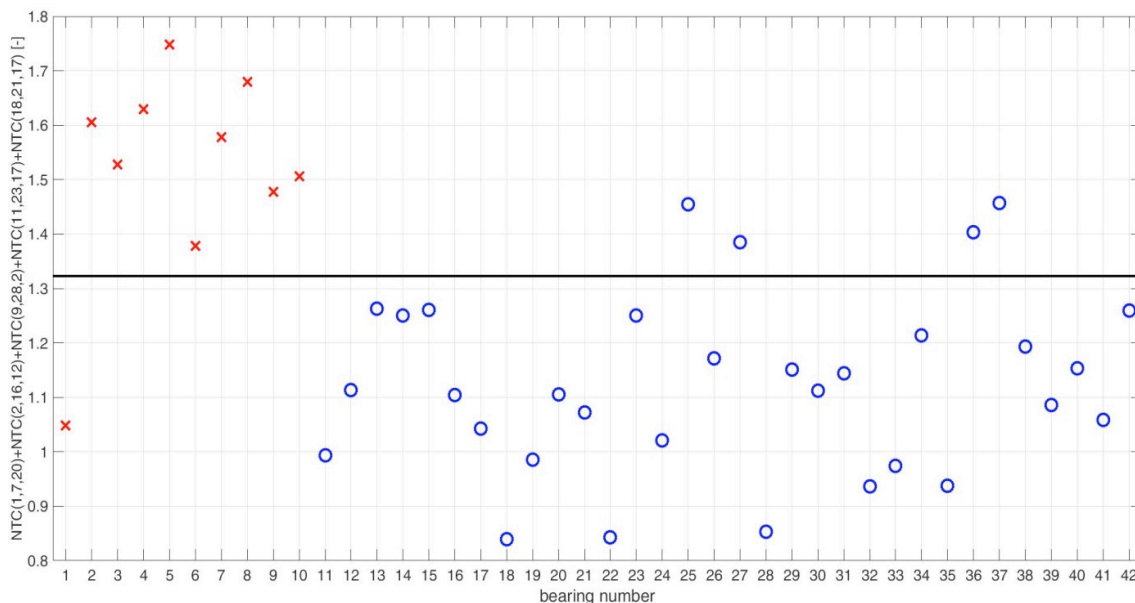

Figure 6. Value of DI for different bearings for set 1.

Set 2:

Damaged: 1, 4, 5, 7, 9

Undamaged: 13, 14, 15, 16, 17, 21, 26, 27, 30, 31, 32, 36, 38, 40, 41, 42

Fisher's criterion: 3.2

The ratio of good diagnosis compared to all is:

Damaged: 5/5=100%; Undamaged: 14/16=88%; All: 19/21=90%

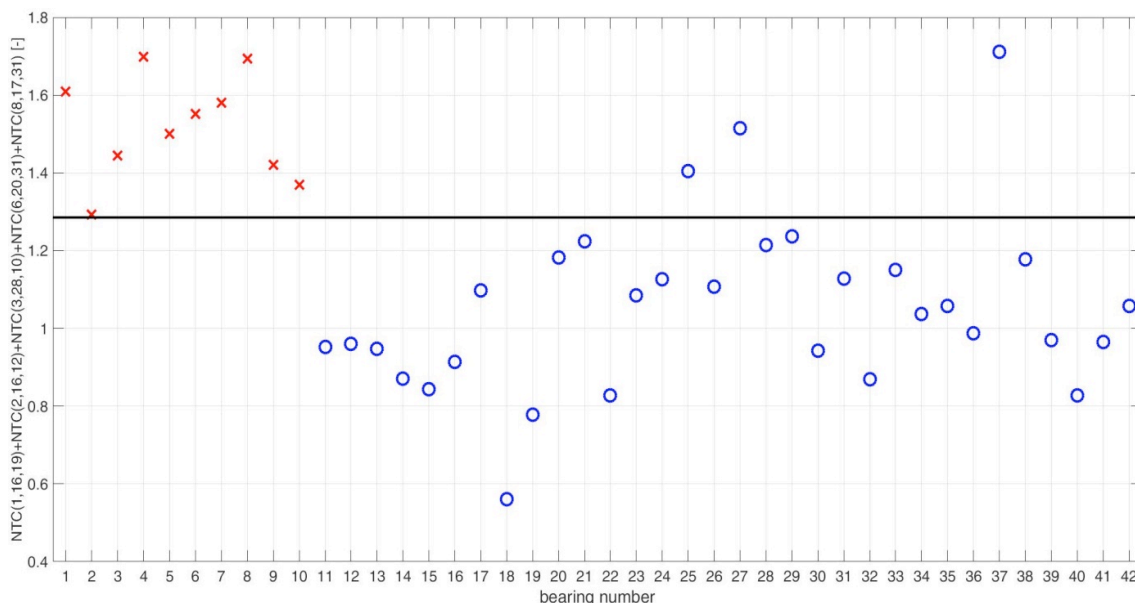

Figure 7. Value of DI for different bearings for set 2.

Set 3:

Damaged: 1, 4, 5, 9, 10

Undamaged: 13, 14, 15, 16, 17, 18, 19, 21, 26, 27, 29, 33, 36, 38, 39, 41

Fisher's criterion: 3.0

The ratio of good diagnosis compared to all is:

Damaged: 5/5=100%; Undamaged: 13/16=81%; All: 18/21=86%



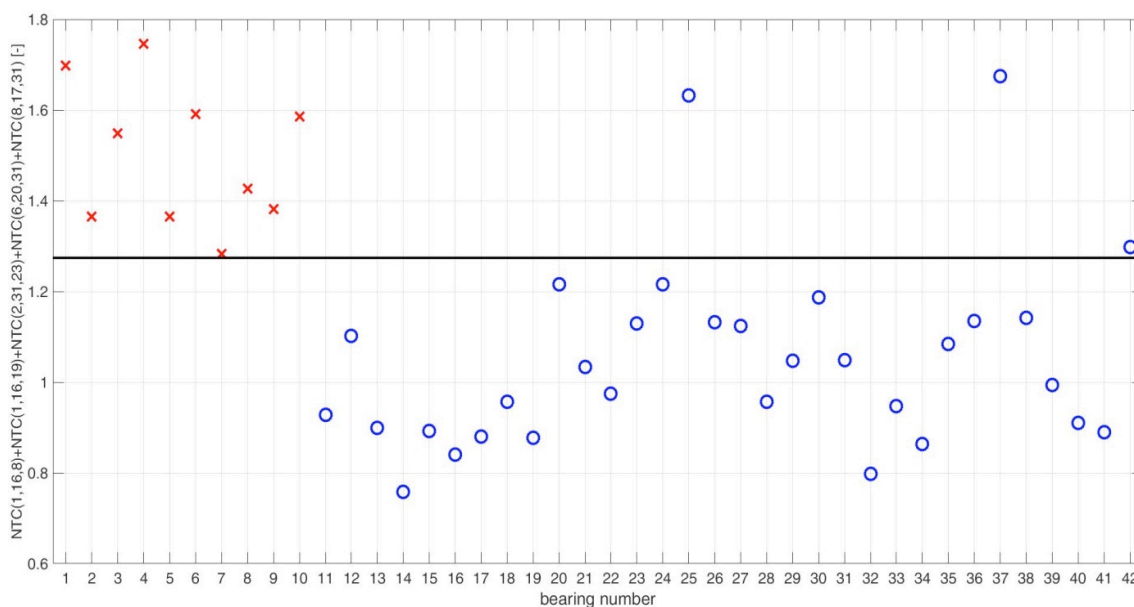

Figure 8. Value of DI for different bearings for set 3.

Presented results were achieved in conditions of full load of the motor which is very important for industrial applications. Measurements of current can be taken during normal operation of the motor in a non-invasive way.

4. Conclusions

Both methods, developed in GUT (the second method in collaboration with Cranfield University), are very promising. Accuracies of diagnoses are comparable with accuracies of vibration based methods for bearings diagnostic.

The vibration diagnostic system that was used to verify the results obtained by the IP analysis, reported concurrent results with the results obtained from the tests on the technical condition of the tested bearings. The presence of both the component characteristic for the damage type of a given rolling bearing and other components associated with this frequency enables the use of IP signal as a diagnostic symptom to assess the technical state of bearings in induction motors.

The authors plan further work related to a more precise definition of the interdependencies between instantaneous power spectral components and bearing failures by achieving greater accuracy in analogue-digital processing and minimizing the noise of their own measurement path.

Research also shows that the NTC is a very efficient diagnostic feature for diagnosis of IM bearings through the MCSA. Preliminary tests performed for this novel method are very promising.

Conducted research confirmed very good diagnostic properties of MCSA with the NTC for diagnosis of bearings in IM. Accuracy of diagnoses for all bearings reached 90% for set 2 and 86% for other sets.

In order to implement the method for industrial use, more research on a significantly larger group of test objects is needed for extensive statistical results.



Authors plan to build a dedicated stand for bearings damaging, to better simulate natural damage and get more and higher quality test objects to extend the research with this method. It is also planned to test the NTC method on other types of bearings and motors.

5. References

1. Wei Zhou; T G Habetler, R G Harley, 'Incipient Bearing Fault Detection via Stator Current Noise Cancellation Using Wiener Filter', IEEE International Symposium on Diagnostics for Electrical Machines, Power Electronics and Drives, Cracow 2007, pp. 11-16.
2. L Frosini, E Bassi, C Gazzaniga, 'Effect of the bearings faults on the efficiency of the induction motors', IECON 2008. 34th Annual Conference of IEEE Industrial Electronics, 2008. 10-13 Nov. 2008, pp. 1167-1172.
3. J Zarei, J Poshtan, 'An advanced Park's vectors approach for bearing fault detection', Tribology International, Volume 42, Issue 2, Feb. 2009, pp. 213-219.
4. A Ibrahim, M El Badaoui, F Guillet, F Bonnardot, 'A new bearing fault detection method in induction machines based on instantaneous power factor', IEEE Transactions on Industrial Electronics. Volume 55, Issue 12, Dec. 2008, pp. 4252-4259.
5. A Dzwonkowski, L Swędrowski, 'Bearing fault diagnosis in induction motors by instantaneous power analysis', Conference proceedings. The Seventh International Conference on Condition Monitoring and Machinery Failure Prevention Technologies CM 2010. The British Institute of Non-Destructive Testing, pp.1-12.
6. A Dzwonkowski, L Swędrowski, J Rusek, 'The instantaneous power as a diagnostic symptom of the bearing damage', The Fifth International Conference on Condition Monitoring and Machinery Failure Prevention Technologies CM 2008/MFPT 2008, Heriot-Watt University, Edinburgh, Scotland, UK, 15-18 July 2008, pp. 361-371.
7. A Dzwonkowski, L Swędrowski, 'Uncertainty analysis of measuring system for instantaneous power research', Metrology and Measurement Systems, Vol. XIX (2012), No. 3, pp. 573-582, Index 330930, ISSN 0860-8229.
8. T Ciszewski, L Gelman, L Swędrowski, 'Current-based higher-order spectral covariance as a bearing diagnostic feature for induction motors', Insight - Non-Destructive Testing and Condition Monitoring, August 2016, vol. 58, no. 8, pp. 431-434.
9. L Gelman, 'The New Second and Higher Order Spectral Technique for Damage Monitoring of Structures and Machinery', International Journal of Prognostics and Health Management, Vol 5 (2) 007, pp 6, 2014.
10. L Swędrowski, J Rusek, 'Model and Simulation Tests of a Squirrel – Cage Induction Motor with Oscillation of the Air Gap', Proc. SDEMPED 2005 - International Symposium on Diagnostics for Electrical Machines, Power Electronics and Drives, Vienna, Austria, September 2005, pp 1-5.

