

PROBLEMS OF THE STARTING AND OPERATING OF HYDRAULIC COMPONENTS AND SYSTEMS IN LOW AMBIENT TEMPERATURE (PART IV)

MODELLING THE HEATING PROCESS AND DETERMINING THE SERVICEABILITY OF HYDRAULIC COMPONENTS DURING THE STARTING-UP IN LOW AMBIENT TEMPERATURE

Ryszard Jasiński

Gdańsk University of Technology, Poland

ABSTRACT

Designers of hydraulically driven machines and devices are obliged to ensure during design process their high service life with taking into account their operational conditions. Some of the machines may be started in low ambient temperature and even in thermal shock conditions (due to delivering hot working medium to cold components). In order to put such devices into operation appropriate investigations, including experimental ones - usually very expensive and time-consuming, are carried out. For this reason numerical calculations can be used to determine serviceability of a hydraulic component or system operating in thermal shock conditions. Application of numerical calculation methods is much less expensive in comparison to experimental ones. This paper presents a numerical calculation method which makes it possible to solve issues of heat exchange in elements of investigated hydraulic components by using finite elements method. For performing the simulations the following data are necessary: ambient temperature, oil temperature, heat transfer coefficient between oil and surfaces of elements, as well as areas of surfaces being in contact with oil. By means of computer simulation method values of clearance between cooperating elements as well as ranges of parameters of correct and incorrect operation of hydraulic components have been determined. In this paper results of computer simulation of some experimentally tested hydraulic components such as axial piston pump and proportional spool valve, are presented. The computer simulation results were compared with the experimental ones and high conformity was obtained.

Keywords: hydraulic drive, hydraulic components, thermal shock, computer simulation

INTRODUCTION

Hydraulic system components operate in various climatic conditions [33-35]. Users of hydraulically driven devices expect their proper work in a.o. low ambient temperature and thermal shock conditions (due to supplying cold components with hot hydraulic liquid).

Development of computer technique made it possible to model various phenomena which occur in hydraulic components of machines and devices. Owing to that it is possible to carry out diagnoses for determining their correct operation in thermal shock conditions. Heating processes of hydraulic devices during such start-up can be modelled by using numerical methods incorporated in NASTRAN, ANSYS, FLUENT and other software systems [13, 20, 21].

In order to perform computer simulation of heating process of cold elements of a hydraulic component after its start-up it is necessary to work out an appropriate model and assume initial and boundary conditions.

Pumps, hydraulic motors and valves are the basic hydraulic system components in which energy losses occur. The losses are classified into volumetric, pressure and mechanical ones and determined for a given hydraulic device in steady conditions with neglecting as a rule impact of heat exchange in such device as that insignificant in total balance of energy losses [1, 17-19, 22-27, 29, 32]. In start-up process of a hydraulic machine or device the heat exchange on the path of working medium, i.e. between elements of hydraulic components and environment, highly influences effectiveness of energy

conversion in the components of devices especially during starting-up cold components supplied with hot working medium as it was proved a.o. in the publications [2-12]. Hence the issues, considered in this paper, of modelling the heating processes during starting-up in thermal shock conditions, which take place in axial piston pump and proportional spool valve, are purposeful and justified. One may be acquainted with operating principles of various hydraulic components as well as results of their tests in low ambient temperature by studying a.o. the publications [1-12, 30].

INTRODUCTION TO ISSUES OF UNSTEADY CONDUCTIVE HEAT TRANSFER

The supplying of hydraulic components with hot working medium results in unsteady heating their parts (elements) [2-12]. Temperature of component parts varies in time. Application of conductive heat transfer differential equation it is possible to determine temperature field distribution in component parts. To determine the differential equation of conductive heat transfer in elements of the component it is necessary to create energy balance equation for elementary volume of its body [21, 28, 31].

The energy balance for a cuboid of dV volume during heating at $d\tau$ time interval, taking into consideration the internal heat source q_V , can be expressed by the following equation [31]:

$$dQ_x + dQ_y + dQ_z + q_V dV d\tau = dQ + dQ_{x+dx} + dQ_{y+dy} + dQ_{z+dz} \quad (1)$$

where:

dQ – energy increase of cuboid,

dQ_x, dQ_y, dQ_z – heat transported to cuboid surface in the direction of x -, y - and z - axis, respectively,

$dQ_{x+dx}, dQ_{y+dy}, dQ_{z+dz}$ – heat transported from cuboid surface in the direction of x -, y - and z - axis, respectively.

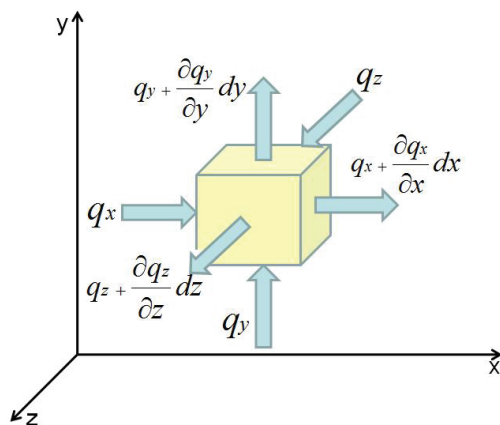

Fig.1. Unsteady conductive heat transfer through elementary volume $dV=dx dy dz$ of solid body [8, 28, 31]

The heat dQ_x, dQ_y, dQ_z is delivered to three surfaces of the cuboid and in the same time the heat $dQ_{x+dx}, dQ_{y+dy}, dQ_{z+dz}$

is transported from the other three surfaces shifted by the distances dx, dy, dz from the initial ones, respectively.

The heat dQ which influences on energy increase of the cuboid of dV volume (Fig. 1) is equal to:

$$dQ = q_x dy dz d\tau - \left(q_x + \frac{\partial q_x}{\partial x} dx \right) dy dz d\tau + q_y dx dz d\tau - \left(q_y + \frac{\partial q_y}{\partial y} dy \right) dx dz d\tau + q_z dx dy d\tau - \left(q_z + \frac{\partial q_z}{\partial z} dz \right) dx dy d\tau + q_V dV d\tau \quad (2)$$

The energy increase dQ in the cuboid of dV volume of the solid body can be described as follows:

$$dQ = c_p \rho \frac{\partial T}{\partial \tau} dV d\tau \quad (3)$$

where:

c_p – specific heat at constant pressure,
 ρ – density.

After transformation of Eq. 2 and 3 as well as by taking into account value of heat generated inside the volume dV , the following equation was obtained :

$$\frac{\partial T}{\partial \tau} = -\frac{1}{c_p \rho} \left(\frac{\partial q_x}{\partial x} + \frac{\partial q_y}{\partial y} + \frac{\partial q_z}{\partial z} \right) + \frac{q_V}{c_p \rho} \quad (4)$$

The heat flux transported through the hydraulic component elements is proportional to temperature gradient in accordance with Fourier law :

$$q = -\lambda \nabla T \quad (5)$$

where : q - heat flux,

λ - thermal conductivity,

∇ - nabla operator,

T - temperature.

Simultaneous using of the Fourier law and the energy balance leads to the differential equation which describes temperature field in fixed isotropic component elements [28, 31]:

$$\frac{\partial T}{\partial \tau} = \frac{1}{c_p \rho} \left(\frac{\partial}{\partial x} \left(\lambda \frac{\partial T}{\partial x} \right) + \frac{\partial}{\partial y} \left(\lambda \frac{\partial T}{\partial y} \right) + \frac{\partial}{\partial z} \left(\lambda \frac{\partial T}{\partial z} \right) \right) + \frac{q_V}{c_p \rho} \quad (6)$$

The differential equation of unsteady conductive heat transfer through elements of the component without internal heat sources and at $\lambda = idem$ is presented below:

$$\frac{\partial T}{\partial \tau} = a \left(\frac{\partial^2 T}{\partial x^2} + \frac{\partial^2 T}{\partial y^2} + \frac{\partial^2 T}{\partial z^2} \right) = a \nabla^2 T \quad (7)$$

where: $a = \frac{\lambda}{c_p \cdot \rho}$ - thermal diffusivity,
 ∇^2 - Laplace operator.

The calculation of the temperature field from differential equation of unsteady conductive heat transfer is possible if only initial and boundary conditions are known. Initial conditions determine initial distribution of temperature in the considered component. Boundary conditions inform about quantities which determine heat flux on surfaces of hydraulic component elements. To perform computer simulation of heating process of component elements, 3rd type of boundary conditions comprising the oil temperature T_{ol} and the heat transfer coefficient α_w between oil and surfaces of component elements, were used.

The oil temperature T_{ol} was measured by help of temperature sensors. The heat transfer coefficient was determined on the basis of experimental tests [2-12].

EXPERIMENTAL TESTS AND COMPUTER SIMULATION OF HEATING PROCESS IN ELEMENTS OF AXIAL PISTON PUMP

Experimental tests of the axial piston pump with cam-driven commutation unit (shown in Fig. 2) during start-up in thermal shock conditions, were performed in the Hydraulics Laboratory of the Faculty of Mechanical Engineering of the Gdańsk University of Technology.

The Laboratory is equipped with a.o. multipump supply devices with oil temperature stabilization, devices for testing hydraulic components and systems as well as a system for measuring and recording mechanical, hydraulic and thermal quantities.

In low temperature chambers it was possible to cool down hydraulic components up to temperature not lower than $-25\text{ }^\circ\text{C}$ (in one of the chambers – even down to $-38\text{ }^\circ\text{C}$). The tests were conducted without forced air flow. The supply oil temperature was kept in the range from 20 to $60\text{ }^\circ\text{C}$ (usually at $50\text{ }^\circ\text{C}$) by means of an oil temperature stabilizing system.

During start-up of the hydraulic pump, time characteristics of the following quantities were recorded: pressure and temperature (Pt100 sensors) in suction and pressure connections of the pump, rate of flow, pump shaft rotational speed, temperature in low temperature chamber, temperature in many points of the pump in question (thermocouples), pump shaft torque. An Advantech VisiDAQ system was used for transmitting and recording the data in computer.

The tests of the pump were made for the following parameters: oil temperature of about $48\text{ }^\circ\text{C}$, ambient temperature in the range from -21 to $+23\text{ }^\circ\text{C}$, pump shaft rotational speed in the range from 500 to 2500 rpm, pressure in the range from $4,5$ to 12 MPa. For the parameters a dozen or so measuring series of pump start-up in thermal shock conditions were performed [3, 4, 7, 11]. As a result,

characteristics of: temperature changes while heating the fixed and mobile elements, oil inlet and outlet temperature as well as oil leakage temperature, were achieved. Moreover, characteristics of other pump parameters such as e.g. hydraulic-mechanical efficiency, were determined.

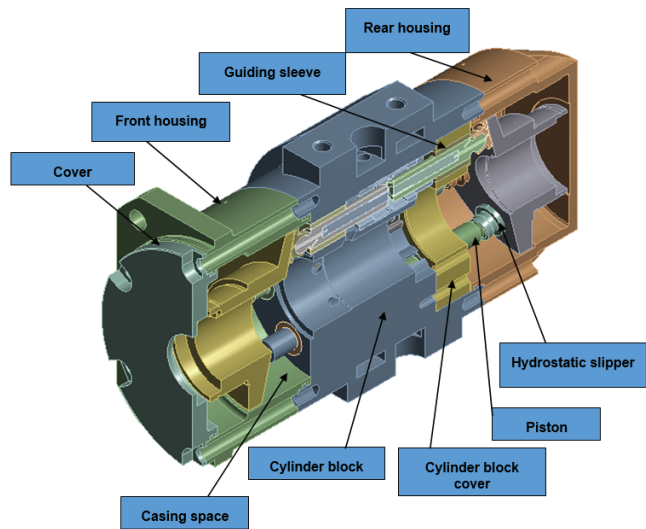

Fig. 2. Elements of axial piston pump [14-16, 33]

It was observed that pump fixed elements (Fig. 2) such as cover, front and rear housing were heated up with some delay in relation to the cylinder block and cylinder block cover in initial phase of start-up.

The delay results from that in the instant of start-up cold oil is present in the internal space of the pump (casing space). At the beginning it becomes warmer as a result of oil mixing due to influence of revolutions of swash plate and to and fro motion of pistons. Additionally, the oil in casing space is heated by leakages from clearance between piston and guiding sleeve as well as slipper and swash plate of the pump. Results of the experimental tests of the pump are described in detail in [3, 4, 7, 11].

Because of different heating rate in the fixed elements of the pump the elements have been split into two groups. The first group contains elements of cylinder block component (cylinder block, cylinder block cover), and the second group comprises elements of housing (cover, front housing, rear housing).

During the experimental tests of the pump two cases of its start-up were considered. In one of the cases uniform rate of heating the pump pistons was applied, in the other - two-phase heating the pistons and hydrostatic slipper was used. The first phase was characterized by fast heating rate of the pistons and hydrostatic slipper (about 30 s). Later the heating process was slower. Results of the experimental tests are described in detail in [3, 4, 7, 11].

For carrying out computer simulation it is necessary to determine heat transfer coefficients from oil to mobile and fixed elements of the pump. It is possible this way to compare real characteristics of heating the pump elements with those obtained as a result of computer simulation.

To determine the heat transfer coefficients $\alpha_w = f(n)$ in function of rotational speed, the experimental test data (temperature characteristics of elements) were used [3, 4, 7, 11, 12].

The characteristics of the heat transfer coefficients in function of pump rotational speed for the cylinder block of component, presented in Fig. 3, can be described by the following straight line equation: $\alpha_{w1n} = 0,321 \cdot n + 92,8$ (n – rotational speed).

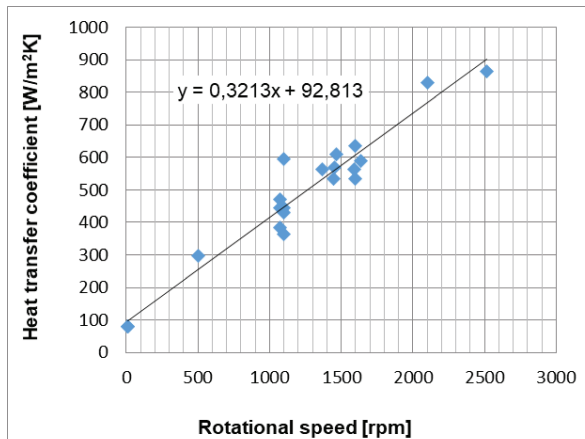

Fig. 3. The heat transfer coefficients from oil to surfaces of cylinder block and cylinder block cover in function of pump rotational speed [12]

Fig. 4 shows the determined characteristics of the heat transfer coefficients in function of pump rotational speed for the following elements: the cover, front housing and rear housing, which can be described by the straight line equation as follows: $\alpha_{w2n} = 0,266 \cdot n + 51,95$.

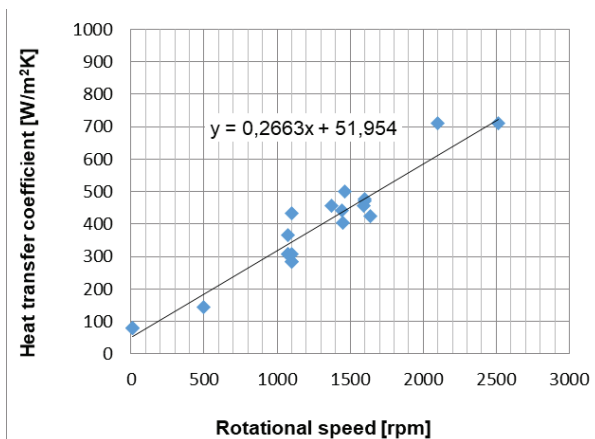

Fig. 4. The heat transfer coefficients from oil to surfaces of cover, front housing and rear housing in function of pump rotational speed [12]

It can be noticed that values of the heat transfer coefficients for the cylinder block component (cylinder block, cylinder block cover) are greater by about 20 % than those for the pump housing elements (cover, front housing, rear housing).

The numerical calculation method based on finite elements makes it possible to solve dynamic issues of heat exchange in investigated model. The data necessary to perform the simulation were the following: ambient temperature, oil

temperature, determined heat transfer coefficient (Fig. 3 and 4) as well as areas of element surfaces being in contact with oil.

Having in one's disposal these data one was able to perform computer simulation of the heating process in elements of the investigated pump during its start-up in thermal shock conditions. The model containing mobile and fixed parts of the pump was split into finite elements. The computer simulations of the heating of pump elements in thermal shock conditions were conducted for a few different sets of parameters. The most interesting results of the simulations carried out for the following parameters: ambient temperature of -20°C , oil temperature of 48°C , rotational speed of 1100 rpm and pressure of 5.2 MPa, are presented below. During the test, temperature was measured in both fixed and mobile elements.

For numerical calculations heat transfer coefficients of the pump elements were assumed on their surfaces (Fig. 5). Tab.1. presents values of definite heat transfer coefficients. The pump was tested for two-phase heating process of piston. In this case two values of the heat transfer coefficient from oil to piston surfaces, were assumed.

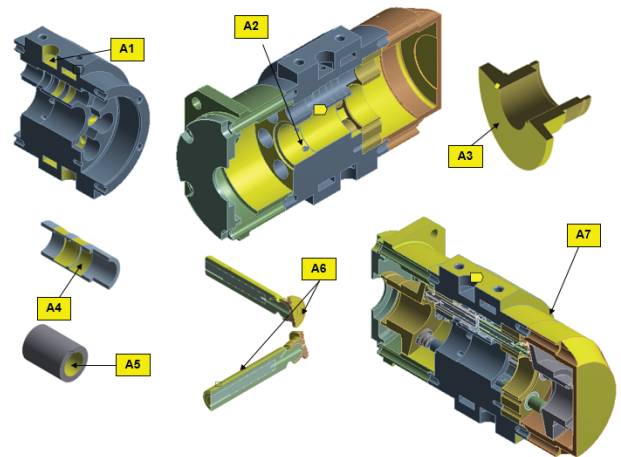

Fig. 5. Defined heat exchange surfaces of the pump

On the surfaces of mobile and fixed elements the following values of the heat transfer coefficient from oil to respective surfaces were assumed:

- for surface of cylinder block - $430 \text{ [W/m}^2\text{K]}$,
- for surface of housing - $285 \text{ [W/m}^2\text{K]}$,
- for surface of swash plate - $115 \text{ [W/m}^2\text{K]}$,
- for surface of piston - $150 \text{ [W/m}^2\text{K]}$ (during the time interval of $0 \div 30 \text{ s}$), and $40 \text{ [W/m}^2\text{K]}$ (during the time interval of $31 \div 500 \text{ s}$).

Tab. 1. Heat exchange surfaces with assumed heat transfer coefficients from oil to the pump elements (A1-A6) and from the pump elements to the environment (A7).

Heat exchange surface	Heat transfer coefficient	Initial temperature of surface
	[W/m ² K]	[°C]
A1	430	48

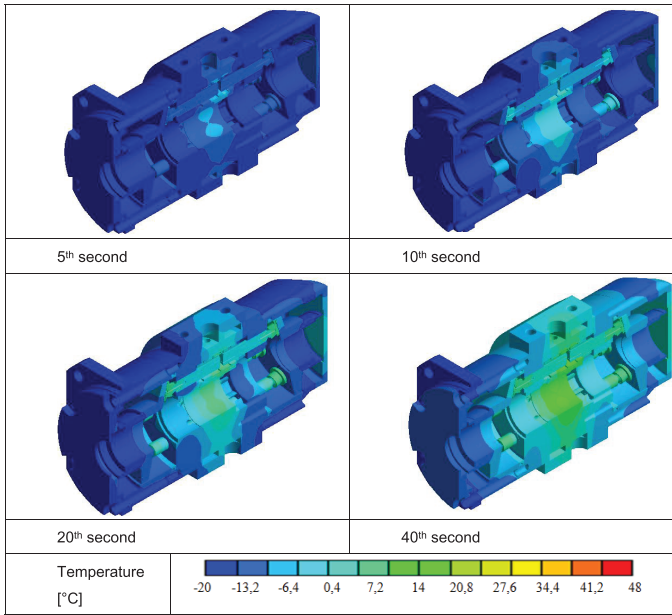

Fig. 6. Temperature distribution in mobile and fixed elements in subsequent seconds of pump start-up in thermal shock conditions for the following working parameters of the pump after its start-up: cooling chamber temperature $t_{ot} = -20^{\circ}\text{C}$, oil temperature $t_{oi} = 48^{\circ}\text{C}$, rotational speed $n = 1100 \text{ rpm}$, pressure $p = 5,2 \text{ MPa}$.

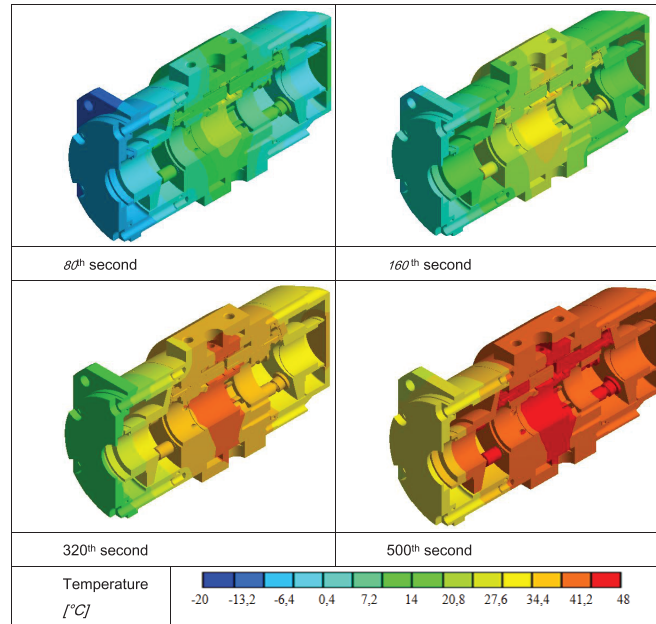

Fig. 7. Temperature distribution in mobile and fixed elements in subsequent seconds of pump start-up process for the following working parameters of the pump after its start-up: cooling chamber temperature $t_{ot} = -20^{\circ}\text{C}$, oil temperature $t_{oi} = 48^{\circ}\text{C}$, rotational speed $n = 1100 \text{ rpm}$, pressure $p = 5,2 \text{ MPa}$.

A2	285	48
A3	115	48
A4	430	48
A5	40	48
A6	150 (0÷30s), 40 (31÷500s)	48
A7	12	-20

Fig. 6 and 7 present temperature distribution in mobile and fixed elements in subsequent seconds of pump start-up in thermal shock conditions.

It can be observed that the pump heating process begins in places which are in direct contact with flowing hot oil. These are surfaces of internal channels of the pump through which hot working medium flux flows. As a result, the cylinder block component of the pump is the element which becomes heated the fastest.

During the first 40 s of the start-up process the difference between the highest and the lowest temperature occurring in fixed elements of the pump is equal to about 35°C . The front housing and cover become heated the slowest. In spite of that the front housing is of similar mass compared to that of the rear housing, the rear housing becomes heated much more fast during later phase of start-up. It results from that the area of the rear housing surface which is washed by oil is greater than that of front housing. Despite the insulation, the heat flows from the front housing to the stand.

COMPARISON OF TEMPERATURE CHARACTERISTICS OF THE ELEMENTS OBTAINED FROM THE EXPERIMENT WITH THOSE RESULTING FROM THE COMPUTER SIMULATION DURING HEATING THE TESTED PUMP

In order to check conformity of heating temperature characteristics of the elements of the experimentally tested pump with those resulting from the numerical calculations, in the model (Fig. 8) points were selected in the same places where temperature were measured by means of the thermocouples T1-T8 in the tested component [3, 4, 7, 11].

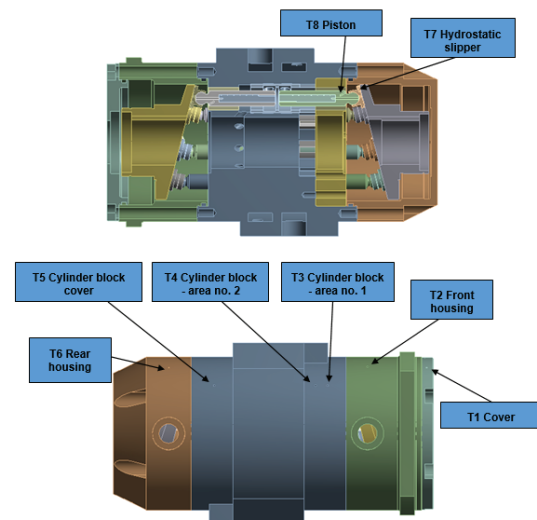

Fig. 8. Points where temperature was recorded during computer simulation of heating process in mobile and fixed elements of the pump

Comparing cover's temperature characteristics obtained from the experiment to ones obtained from computer simulation (Fig. 9), it can be observed that there is high conformity between them. In the initial phase the temperature according to the computer simulation is only slightly higher than that from the experiment. It so happens because during temperature measurement in real conditions heat is transferred to the cover with a delay.

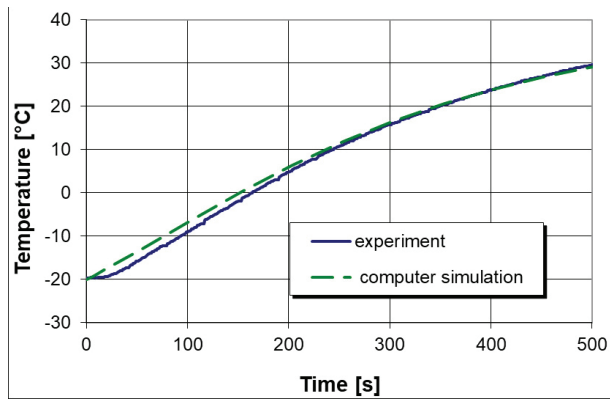

Fig. 9. Temperature of the cover obtained from experimental test and computer simulation (T1 - Fig. 8)

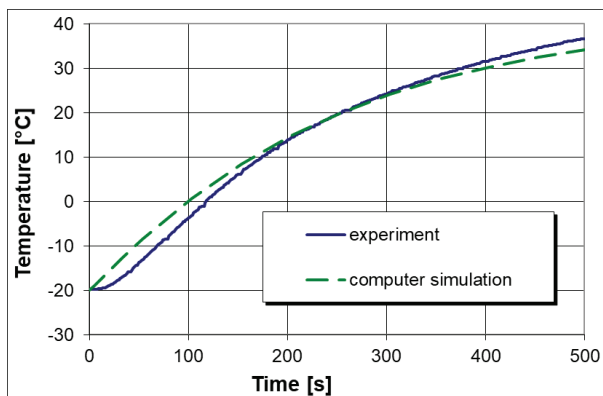

Fig. 10. Temperature of the front housing obtained from experimental test and computer simulation (T2- Fig. 8)

High conformity is observed between the heating characteristics obtained from the computer simulation and the experiment for the front housing (Fig. 10) and cylinder block (Fig. 11).

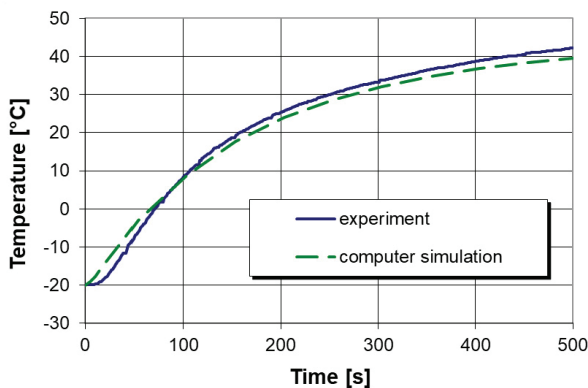

Fig. 11. Temperature of the cylinder block obtained from experimental test and computer simulation (T3- Fig. 8)

Fig. 12 presents the temperature characteristics obtained from the experimental tests and numerical calculations for the cylinder block cover. After about 70 s from the instant of starting up the cold pump, temperature of the cylinder block cover according to the computer simulation is by a few grades lower than that from the experiment. It is consequence of a simplification introduced to the structural computer model of the pump. Additionally, the cylinder block cover is washed by the oil heated in pump casing space chamber due to mechanical friction in ball bearings, internal friction of oil under intensive mixing with that from leakages.

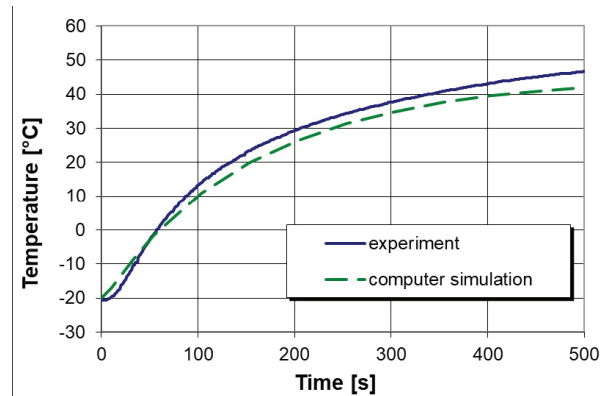

Fig. 12. Temperature of the cylinder block cover obtained from experimental test and computer simulation (T5 - Fig. 8)

For modelling the heating process of piston, two values of the heat transfer coefficient from oil to washed surface of the piston and hydrostatic slipper, were used. This ensured a good conformity of results. The hydrostatic slipper temperature according to the computer simulation is only slightly lower than that from the experimental tests (Fig. 13). One of the reasons is that a lower temperature of oil was assumed in the model. The oil temperature in pump casing space in steady conditions is higher than that of oil delivered to the pump. The higher pumping pressure in the pump the higher oil temperature in its casing space.

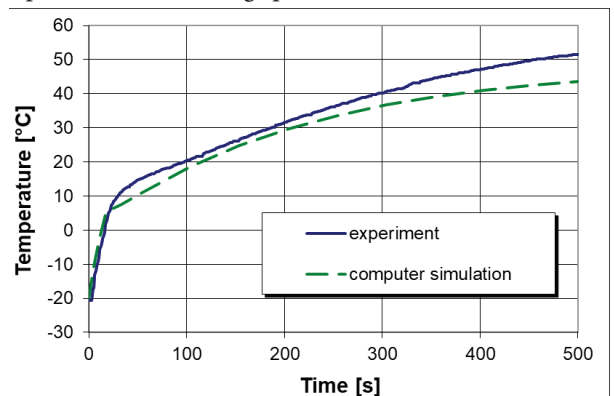

Fig. 13. Temperature of the hydrostatic slipper obtained from experimental test and computer simulation (T7 - Fig. 8)

Summing up the results of the investigation of the axial piston pump performed by using the computer simulation

one is able to state that they are close to those obtained from the experiment. It results from that the values of the heat transfer coefficient from oil to surfaces of mobile and fixed elements, determined on the basis of the experiment results, can be considered correct. It was proved that it is possible to simulate heating processes in the pump elements with high accuracy.

DETERMINATION OF SERVICEABILITY OF AXIAL PISTON PUMP DURING ITS START-UP IN THERMAL SHOCK CONDITIONS ON THE BASIS OF MODEL TESTS WITH THE USE OF COMPUTER SIMULATION

To assess serviceability of axial piston pump (Fig. 2) during its start-up in thermal shock conditions, by means of the computer simulation method, a simplified computer model was worked out especially for this purpose (Fig. 14).

It differs from the model presented in Fig. 8 by a simplified structure. Heat exchange surfaces as well as quantities of mass of the elements only roughly correspond to real ones. As the pump structure is symmetrical only a half of it was modelled (Fig. 14). The model consists of the cylinder block, cylinder block cover, rear housing, swash plate, piston with hydrostatic slipper. The piston contains a hole throughout its length. The pump model was split into finite elements.

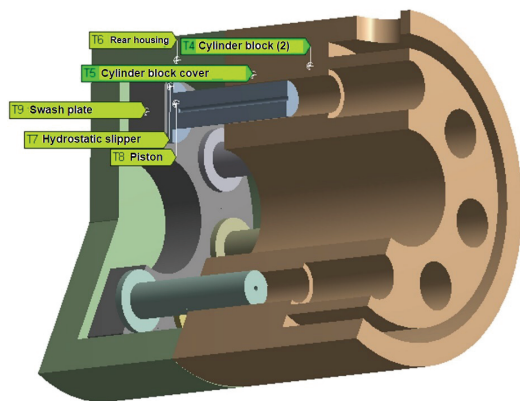

Fig. 14. Arrangement of measurement points in the pump model (the same measurement points are placed in the tested pump – Fig.2, Fig. 8)

Tests of the pump model (Fig. 14) were carried out for the start-up conditions given in Tab. 1. Its heating process was tested by means of numerical calculations.

Fig. 15 presents results of the computer simulation of the heating of the simplified model in the above mentioned

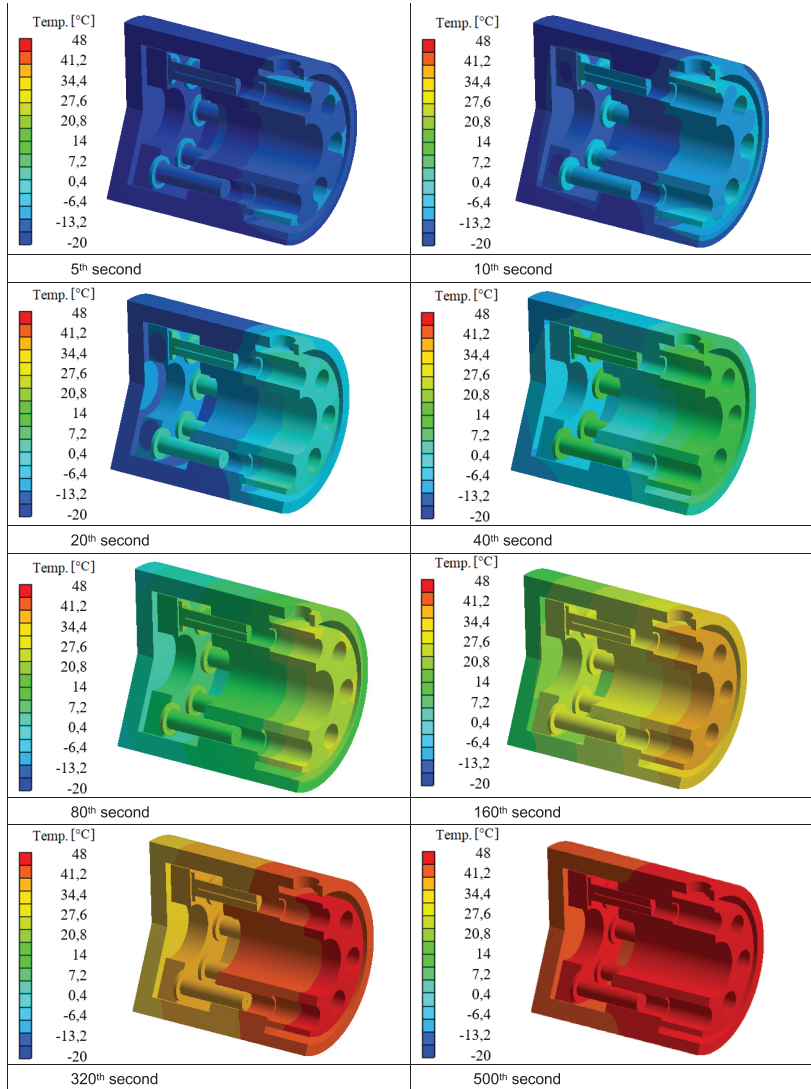

Fig. 15. Temperature distribution in pump model elements in subsequent seconds of pump start-up process for the following working parameters of the pump after its start-up: cooling chamber temperature $t_{ot} = -20\text{ }^{\circ}\text{C}$, oil temperature $t_{oi} = 48\text{ }^{\circ}\text{C}$, rotational speed $n = 1100\text{ rpm}$, pressure $p = 5,2\text{ MPa}$

conditions. The temperature distribution in the pump model elements was prepared for 5th, 10th, 20th, 40th, 80th, 160th, 320th and 500th second of the process. On the basis of the obtained temperature fields in the elements (Fig. 15) it was stated that beginning from 30th second the piston and cylinder block were heated almost with the same rate.

The temperature characteristics obtained from the computer simulation are consistent with those measured during the corresponding experimental test of the pump (parameters of the cold pump start-up: the cooling chamber temperature $t_{ot} = -20\text{ }^{\circ}\text{C}$, oil temperature $t_{oi} = 48\text{ }^{\circ}\text{C}$, rotational speed $n = 1100\text{ rpm}$, pressure $p = 5,2\text{ MPa}$).

Fig. 16 shows the temperature characteristics of: cylinder block cover, cylinder block, rear housing, piston and hydrostatic slipper. The temperature characteristics of the hydrostatic slipper and piston change their character in 31st second. It is connected with the change in the heat transfer coefficient from oil to surfaces of the slipper and piston.

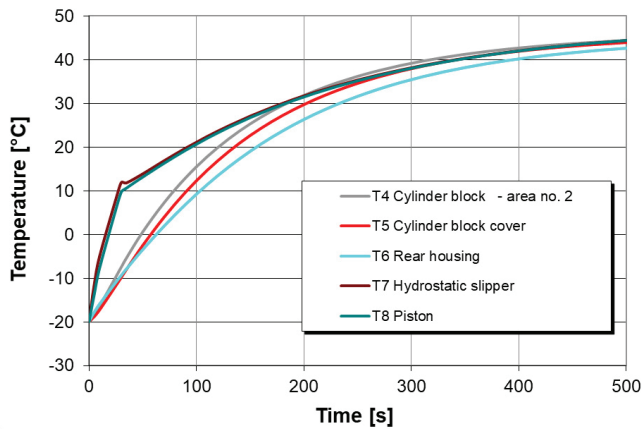

Fig. 16. Temperature of the cylinder block cover, cylinder block, rear housing, piston and hydrostatic slipper for the following initial parameters: oil temperature $t_{oi}=48^{\circ}\text{C}$, ambient temperature -20°C , rotational speed $n=1100\text{ rpm}$, pressure $p=5,2\text{ MPa}$

The temperature characteristic of the hydrostatic slipper obtained from numerical calculations is consistent with that from experimental tests (Fig. 17). As it results, in order to perform computer simulation it is possible to work out a slipper - piston component model which is structurally simplified and made only of one material, e.g. steel.

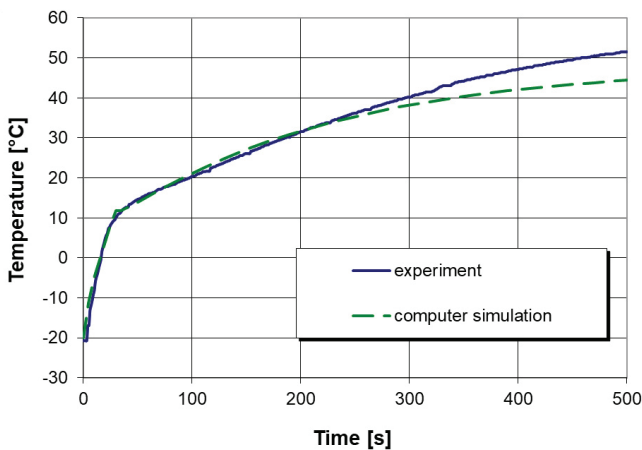

Fig. 17. Temperature of the hydrostatic slipper obtained from experimental test and computer simulation (T 7 - Fig.14)

The structural simplification introduced to the cylinder block model (Fig. 14) did not lower accuracy in determining its temperature characteristic compared to that obtained from the experimental tests. The reached conformity of the temperature characteristics was even greater (Fig. 18) than that resulting from the numerical calculations of the pump (Fig. 12).

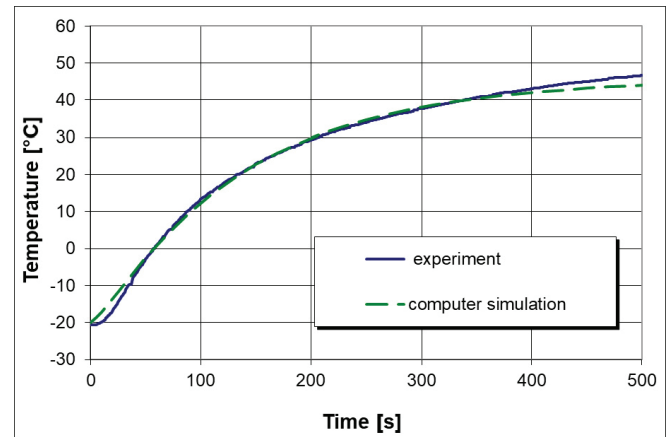

Fig. 18. Temperature of the cylinder block cover obtained from experimental test and computer simulation (T 5 - Fig.14)

During start-up of the cooled pump the pistons are heated from hot oil more fast than the cylinder block (Fig. 16). This is the main cause of change in clearance in these conditions. Change in the effective clearance l_e during start-up can be determine by using the following relation:

$$l_e(\tau) = l_m + \Delta l_p(\tau) - \Delta l_t(\tau) \quad (8)$$

It describes change of the initial clearance l_m by the quantity Δl_p under influence of pressure exerted onto mobile and fixed elements as well as by the quantity Δl_t resulting from thermal expansion of the elements.

The change in clearance by the quantity Δl_t , due to difference in linear thermal expansion of the cooperating component elements, resulting from non-uniform heating during start-up in thermal shock conditions, can be described as follows :

$$\Delta l_t(\tau) = h_R \cdot \beta_R \cdot (T_R(\tau) - T_0) - h_N \cdot \beta_N \cdot (T_N(\tau) - T_0) \quad (9)$$

where:

β_R, β_N - coefficients of linear thermal expansion of the elements: mobile - marked R, fixed - marked N,

$T_R(\tau)$ - temperature of mobile elements,

$T_N(\tau)$ - temperature of fixed elements,

h_R, h_N - linear dimensions of the elements : mobile - marked R, fixed - marked N, determined in the temperature of geometrical measurements T_0 .

Based on the characteristics of temperature difference between piston and cylinder block, the effective clearance between the elements (Fig. 19) was determined under assumption that displacements of cooperating elements resulting from influence of pressure are rather not large. In 31st second from the instant of pump start-up the maximum decrease takes place in the effective radial clearance between piston and guiding sleeve hole. Starting from 250th second the heating process of piston, hydrostatic slipper as well as fixed elements (cylinder block cover) becomes uniform (Fig. 17,

Fig. 18). In this phase the effective clearance does not change almost at all and maintains on the level of $10\ \mu\text{m}$ (Fig. 19).

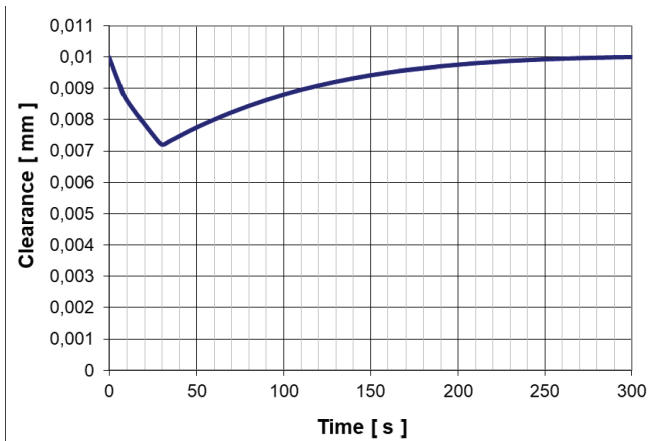

Fig. 19. Change of the clearance between piston and guiding sleeve for the following working parameters of the pump after its start-up: oil temperature $t_{oi}=48^{\circ}\text{C}$, ambient temperature -20°C , rotational speed $n=1100\ \text{rpm}$, pressure $p=5,2\ \text{MPa}$.

The characteristic of the effective clearance between piston and guiding sleeve, obtained from the model tests of the pump by using the computer simulation (Fig. 19), is consistent with that achieved from the experimental tests [4, 7, 11].

INVESTIGATIONS OF HEATING PROCESSES IN ELEMENTS OF THE PROPORTIONAL SPOOL VALVE IN THERMAL SHOCK CONDITIONS WITH THE USE OF COMPUTER SIMULATION METHOD AND COMPARISON OF THEIR RESULTS WITH EXPERIMENTAL DATA

A proportional spool valve was tested in various supply conditions [3-6, 30]. A dozen or so measurement series were conducted in total. The difference between oil temperature and initial temperature of the component was contained within the range of $20\div 75\ \text{K}$. In several cases of operation in thermal shock conditions, apart from a delayed steering reaction, an incorrect operation of the spool valve was observed.

The thermocouples T1 and T2 (Fig. 20) were placed in the spool. The thermocouples T8, T9, T10, T11 and T12 (Fig. 20) were located in the fixed elements of the spool valve: T12 - in the cover, T9 - in the housing to record its temperature close to heat source, and T10 - in the place where the largest amount of housing material is. Temperature of the connection plate was measured by using T11 thermocouple.

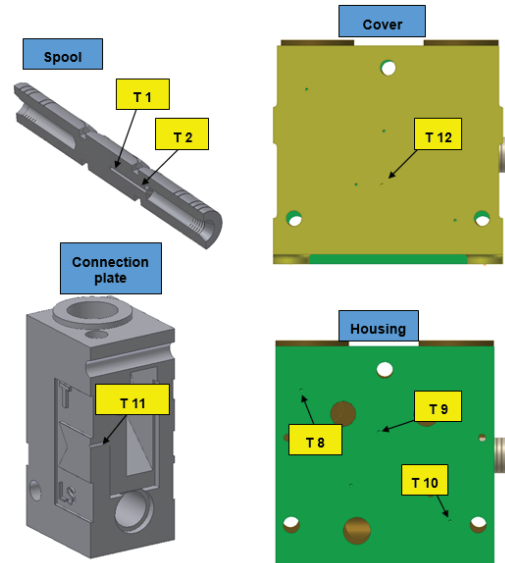

Fig. 20. Arrangement of holes to install the thermocouples T1, T2, T8, T9, T10, T11, T12 in the elements of proportional spool valve model: spool, connection plate, cover and housing

On the basis of the temperature characteristics recorded in the spool valve fixed and mobile elements, values of the heat transfer coefficient from oil to surfaces of the elements were determined in function of flow rate. They can be found in the publication [5].

One of the experimental tests was performed for the following parameters: the flow rate $Q=39\ \text{dm}^3/\text{min}$, ambient temperature of -10°C , oil temperature of 37°C . Numerical calculations were conducted to compare results of heating the spool valve elements. To this end, the following values of the heat transfer coefficient were assumed: from oil to spool surface - $2540\ \text{W}/\text{m}^2\text{K}$, from oil to surfaces of internal channels of the spool valve - $1760\ \text{W}/\text{m}^2\text{K}$, from the external surface of the spool valve to the environment - $12\ \text{W}/\text{m}^2\text{K}$.

To determine the clearance between spool and hole in housing it is necessary to know changes in temperature of the elements.

On the basis of the numerical calculations of the heating process in the spool valve, the temperature distribution in spool valve elements was achieved (Fig. 21) for the rise of the flow rate $Q=39\ \text{dm}^3/\text{min}$ and the initial difference of temperature between oil and the spool valve equal to $57\ \text{K}$.

The calculated temperature characteristic of the spool T1 presented in Fig. 22 differs only slightly from that determined experimentally. The difference between the characteristics obtained from the experiment and computer simulation after 20 s from the start-up instant, is not greater than $3\ \text{K}$.

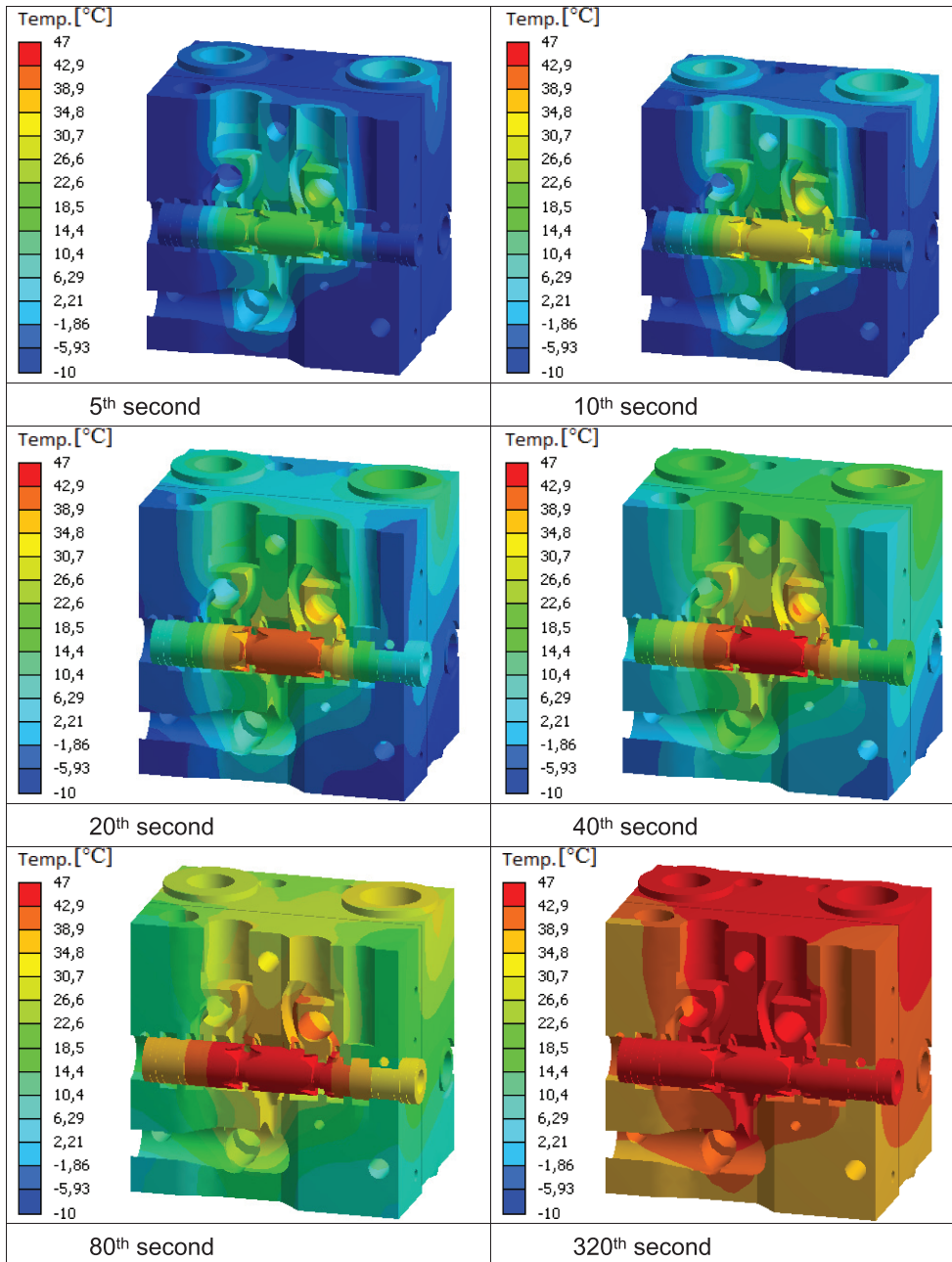

Fig. 21. Temperature distribution in heating elements of proportional spool valve (initial temperature of -10°C , oil flow rate of $39\text{ dm}^3/\text{min}$) counted in 5th, 10th, 20th, 40th, 80th and 320th s after supply of oil in 47°C temperature

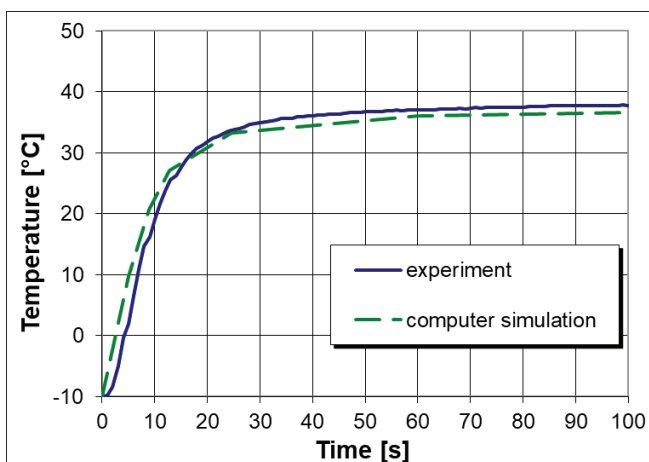

Fig. 22. Temperature of the spool obtained from experimental test and computer simulation (initial temperature of -10°C , oil temperature of 37°C , oil flow rate of $39\text{ dm}^3/\text{min}$)

To determine permissible parameters of correct operation of the spool valve, three series of calculation of heating its elements at the subsequent temperature difference of 47 K, 52 K and 57K between oil and the spool valve (and the assumed ambient temperature of -10°C), were performed. By making use of Eq. (8) the effective clearance values were calculated under assumptions that displacements of the spool and housing resulting from pressure action are rather not big.

The characteristics of the effective clearance between the cooperating elements (i.e. spool and housing of the spool valve) are presented in Fig. 23.

At the initial difference equal to 52 K of temperature between delivered oil and the spool valve (Fig. 23) an instantaneous loss of the clearance between spool and housing takes place in 25th second after start-up of the system including the spool valve. Whereas at the temperature difference of 57 K

(Fig. 23) an instantaneous jamming of the spool in the spool valve housing occurs between 15th and 55th second.

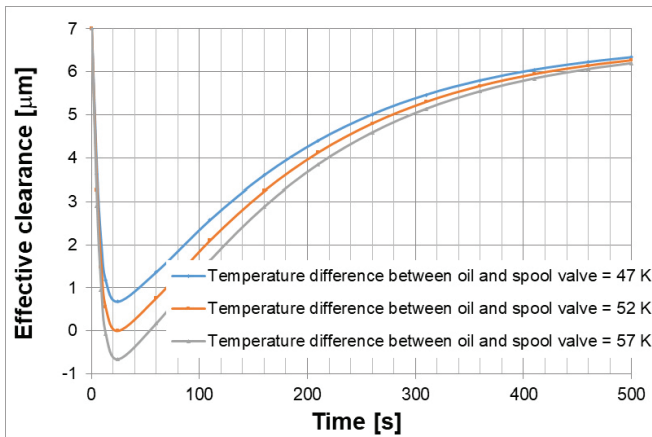

Fig. 23. Effective clearance between the spool and hole in the housing of the proportional spool valve in function of time for the following initial parameters: spool valve temperature of -10 °C, oil temperature of 37, 42, 47 °C, respectively, oil flow rate of 39 dm³/min

The quantity of the clearance determined on the basis of the numerically calculated characteristics of temperature in the spool valve elements is in high conformity with results of the experiment.

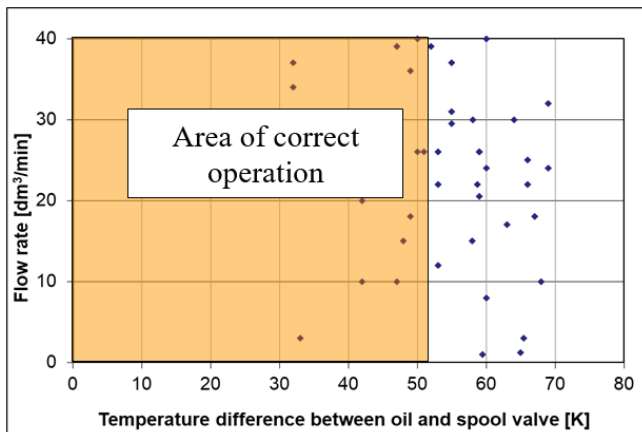

Fig. 24. Areas of correct and incorrect operation of the proportional spool valve with the clearance of 7 μm between the spool and the hole in the housing

The tested proportional spool valve in which the clearance between its spool and hole in the housing equals 7 μm, is resistant to operation in thermal shock conditions at the difference of temperature of hot oil and cold spool valve equal up to 52 K (Fig. 24).

CONCLUSIONS

The temperature characteristics in mobile and fixed elements of the tested hydraulic components, determined by means of computer simulation show high conformity with the characteristics obtained from experimental tests. This means that the experimentally determined heat transfer coefficients

from oil to elements of the components can be considered correct. It was also demonstrated that it is possible to obtain credible results in case of carrying out computer simulation of heating process in elements of hydraulic components in order to determine their serviceability for different initial supply parameters, e.g. a given magnitude of flow rate.

The method worked out by this author for determining the serviceability of hydraulic components in hydraulic shock conditions (Fig. 25) consists in making use of experimentally determined data base containing heat transfer coefficients from oil to surfaces of elements of the components. The coefficients are necessary for carrying out computer simulation of heating processes in components of hydraulic systems. On the basis of temperature characteristics in the elements, the effective clearance between cooperating elements of the hydraulic components and the area of correct operation of the component (and even the whole hydraulic system), was determined.

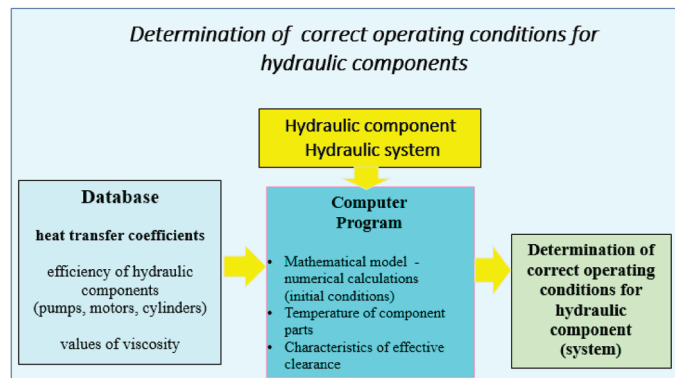

Fig. 25. Assessment of serviceability of hydraulic components and systems on the basis of database containing heat transfer coefficients [9, 10]

The computer simulation method which makes use of numerical calculations (finite elements method) for determining serviceability of hydraulic (system) component consists in determining the area of initial parameters in the start-up instant: ambient temperature, working medium temperature and flow rate (rotational speed) at which the component would operate correctly.

The computer simulation method makes it possible to determine values of clearance between cooperating elements as well as areas of parameters of correct start-ups of hydraulic components with a greater accuracy than that available from the analytical method presented in the publications [5, 6, 8].

BIBLIOGRAPHY

- Balawender A.: Energy analysis and testing methods of slow-speed hydraulic motors (in Polish). Zeszyty Naukowe PG. Gdańsk 1988.
- Jasiński R.: Operation of selected slow-speed hydraulic motors in thermal shock conditions (in Polish). Doctorate

thesis, supervisor: A. Balawender. Gdańsk 2002.

3. Jasiński R.: Problems of the starting and operating of hydraulic components and systems in low ambient temperature (Part I). Polish Maritime Research, 4/2008.
4. Jasiński R.: Problems of the starting and operating of hydraulic components and systems in low ambient temperature (Part II). Determining the clearance between cooperating elements during the hydraulic components start-up in extremely low ambient temperatures on the grounds of experimental research. Polish Maritime Research, 1/2009.
5. Jasiński R.: Problems of the starting and operating of hydraulic components and systems in low ambient temperature (Part III). Methods of determining parameters for correct start-ups of hydraulic components and systems in low ambient temperatures. Polish Maritime Research, 4/2009.
6. Jasiński R.: Research and method for assessment of operation of hydraulic drive components started in low ambient temperature and supplied with hot working medium (in Polish). Report on execution of the research project financed by Polish Ministry of Science and Higher Education (in Polish) , No. 4 T07C042 30, Gdańsk 2010.
7. Jasiński R.: Operation of hydraulic drives in low ambient temperatures. Part II (in Polish). Hydraulika i Pneumatyka, 2/2011.
8. Jasiński R.: Operation of hydraulic drives in low ambient temperatures. Part V (in Polish). Hydraulika i Pneumatyka, 6/2011.
9. Jasiński R.: Determination of ability of machines with hydraulic drive during start-up in low ambient temperatures. Journal of KONES Powertrain and Transport, Vol 1, No. 16, 2009.
10. Jasiński R.: Determination of ability of hydrotronic systems to start in low ambient temperatures. Solid State Phenomena. - Vol. 164, 2010.
11. Jasiński R.: Experimental tests of axial piston pump PWK 27 from HYDROTOR company in low ambient temperatures (in Polish). Napędy i Sterowanie, 4/2008.
12. Jasiński R., Lewandowski P.: Modelling the heating process of axial piston pump PWK 27 from HYDROTOR company during start-up in low ambient temperatures (in Polish). Napędy i Sterowanie, 6/2008.
13. Kleiber M.: Introduction to finite elements method (in Polish). PWN, Warszawa-Poznań, 1989.
14. Landvogt B.; Osiecki L.; Patrosz P.; Zawistowski T.; Zylinski B.: Numerical simulation of fluid-structure interaction in the design process for a new axial hydraulic pump. Progress in Computational Fluid Dynamics. Vol. 14, No. 1, 2014. doi: 10.1504/PCFD.2014.059198.
15. Osiecki A., Osiecki L.: Development efforts on new design of axial piston pumps (in Polish). Hydraulika i Pneumatyka 4/1998, pp. 4–9.
16. Osiecki L., Patrosz P., Zawistowski T., Landvogt B., Piechna J., Żyliński B.: Compensation of pressure peaks in PWK-type hydraulic pumps. Key Engineering Materials. Vol. 490., (2012), s.33-44. doi: 10.4028/www.scientific.net/KEM.490.33.
17. Paszota Z.: Energy losses in hydrostatic drive. LABERT Academic Publishing, 2016.
18. Paszota Z.: Energy losses in the hydraulic rotational motor - definitions and relations for evaluation of the efficiency of motor and hydrostatic drive. Polish Maritime Research 2(65)/2010.
19. Pobędza J., Sobczyk A.: Properties of high pressure water hydraulic components with modern coatings. Advanced Materials Research. Trans Tech Publications Ltd, 849/2014. doi: 10.4028/www.scientific.net/AMR.849.100.
20. Rusiński E.: Finite elements method. COSMOS/M System (in Polish). Wydawnictwa Komunikacji i Łączności, Warszawa 1994.
21. Szargut J.: Numerical modelling of temperature fields (in Polish). WNT, Warszawa 1992.
22. Śliwiński P.: The influence of water and mineral oil on the mechanical losses in a hydraulic motor. Chinese Journal of Mechanical Engineering. Article accepted for publication.
23. Śliwiński P.: Influence of water and mineral oil on the leaks in satellite motor commutation unit clearances. Polish Maritime Research. Article accepted for publication.
24. Śliwiński P.: The influence of water and mineral oil on volumetric losses in a hydraulic motor. Polish Maritime Research, vol. 24, 2017. Doi: 10.1515/pomr-2017-0041.
25. Śliwiński P.: The basics of design and experimental tests of the commutation unit of a hydraulic satellite motor. Archives of Civil and Mechanical Engineering, No. 16/2016, DOI: 10.1016/j.acme.2016.04.003.
26. Śliwiński P.: The flow of liquid in flat gaps of satellite motors working mechanism. Polish Maritime Research, No. 2/2014.

27. Śliwiński P.: New satellite pumps. *Key Engineering Materials*, No. 490/2012.
28. Wiśniewski S., Wiśniewski T.: Heat exchange (in Polish). WNT, Warszawa 2000.
29. Walczak P., Sobczyk A.: Simulation of water hydraulic control system of francis turbine. *American Society of Mechanical Engineers*, 2014. doi: [dx.doi.org/10.1115/FPNI2014-7814](https://doi.org/10.1115/FPNI2014-7814).
30. Rutkiewicz Ł.: Experimental tests of operation of a proportional spool valve in low ambient temperature conditions (in Polish). Diploma thesis, supervisor: R. Jasiński, Gdańsk University of Technology, Gdańsk, 2006.
31. Staniszewski B.: Heat exchange (in Polish). PWN, Warszawa, 1980.
32. Złoto T., Nagorka A.: An efficient FEM for pressure analysis of oil film in a piston pump. *Applied Mathematics and Mechanics*, Vol.30, No. 1/2009.
33. Catalogues from Hydrotor company.
34. Catalogues from Parker company.
35. Catalogues from Sauer-Danfoss company.

CONTACT WITH THE AUTHOR

Ryszard Jasiński

Gdańsk University of Technology
11/12 Narutowicza St.
80 - 233 Gdańsk
POLAND