

The caustic in the acoustics of historic interiors

Andrzej Kulowski

Gdańsk University of Technology, Faculty of Architecture, ul. Gabriela Narutowicza 11/12, 80-233 Gdańsk, Poland

ABSTRACT

In the paper, caustics are discussed as ordered forms of focus broadening occurring in concave mirrors. Presented are examples of caustics formed in natural conditions and application of the phenomenon in different fields of science and technology. Against this factual background, the possibility to observe caustics in rooms is pointed out. Special emphasis is put on large rooms of historic character, as such interiors frequently include acoustic mirrors in the form of arched vaults and concave walls. As a case study, the eighteenth-century Whispering Grottoes representing one of attractions of the Oliwa Park in Gdańsk was selected, where the phenomenon of forming a caustic was used intentionally to obtain the desired acoustic effect.

Keywords: Caustic, Room acoustics, Historic interiors, Whispering gallery, Blurred focus

1. Introduction

In large historical interiors formed by curved surfaces, it is very likely to come across acoustical singularities consisting in “sliding” of sound along a concave wall or concentration of sound in a distant location of the room. The physical nature of these singularities may be different but the effect is the same—two people can hear each other over a large distance without using any additional sound amplification systems.

In contemporary auditoriums, these phenomena are considered an acoustic flaw and are usually effectively corrected. However, the present study deals with rooms created at a time when room acoustics were not yet a scientific discipline in today's sense. The discussed singularities did not subject to acoustic correction, and even their existence was not always noticed.

They can be mostly found in historical premises serving stately, ceremonial, liturgical, or similar purposes where these effects usually were detected accidentally, sometimes many years after erection of the building. Descriptions of these places of interest can be found in books published as early as in the beginnings of development of the architectural acoustics as a scientific discipline [1–4].

The aim of this paper is to prove that the discussed phenomena occur as a result of formation of a caustic, being a specific form of blurring the focus of the rays. The concept of caustics with respect to optical mirrors is known for several centuries (“One of the earliest discoveries in optics (F. Maurolycus, 1575) was that the rays of a normal system are tangential to a surface, the so-called caustic surface.” [5]). However, despite the close relationships between room acoustics and the principles of geometric optics, the term “caustics” in the developed form is in principle absent in the contemporary literature on

room acoustics. The paper discusses in detail the 18th-century historic objects, which have been built from scratch to demonstrate the whispering wall phenomenon to the public, with intentional using the caustic for this purpose.

2. Geometrical model of a sound field in rooms

In this paper, a general assumption of geometrical room acoustics is made that all structures are large compared to the wavelength (so called “optical limiting case”). In this model, the field is composed of sound rays which do not subject to the phenomenon of diffraction. However, in a physical field, the phenomenon of diffraction can significantly influence the form of the field. One of the effects of sound diffraction in rooms is the “recognition” of the obstacle details by the wave front [6]. This reaction is the more accurate, the smaller is the wavelength. This means that waves long enough do not “see” the details of the obstacle and are reflected as from a flat surface.

For the specular reflection, the relationship between the wavelength and the dimensions of the obstacle itself and its elements, i.e. details of its surface, depth of the curvature of the obstacle, etc. is given in Eq. (1)

$$l \leq K\lambda \quad (1)$$

where λ is the length of the longest reflected wave reflected in a specular way; l is the smallest dimension of the obstacle or the size of its detail; and K is a factor dependent on the ratio between mirrored or diffused energy.

In the literature, the value of K is generally larger than 11. This means that for a geometrical reflection, the obstacle with its details should be greater than the wavelength, according to some authors up to 2 times [7] or even more (e.g. $K > 4$ for the screen itself, $K > 1$ for the

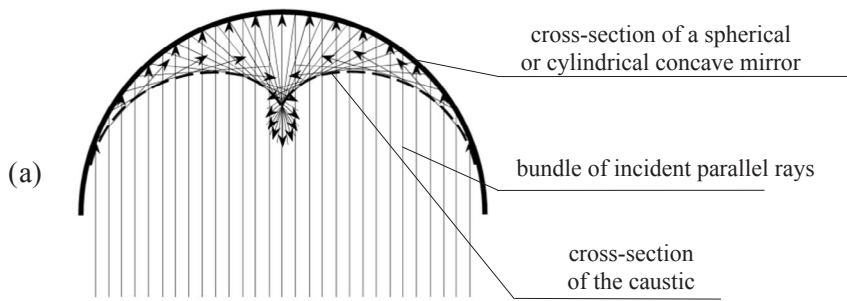
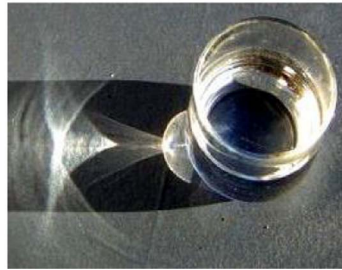

Fig. 1. Catacaustic as a manifestation of spherical aberration of spherical or cylindrical concave mirror: (a) geometrical representation of catacaustic; (b) physical counterpart of the catacaustic drawn in panel (a) [18]; (c) computer simulated superposition of a catacaustic and a diacaustic as a result of light refraction at the boundary between two media and reflection on the inner surface of a vessel [19].



(b)

(c)

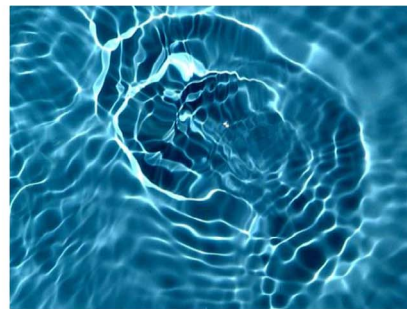
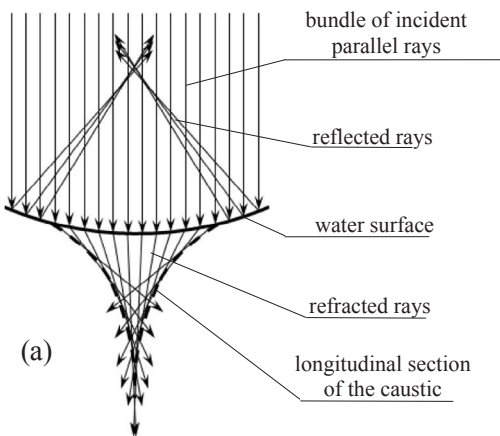
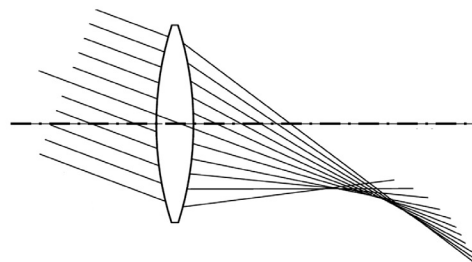
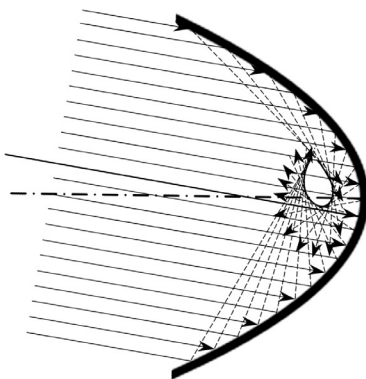

Fig. 2. The diacaustic as an effect of refraction of light on rippled water surface: (a) geometrical representation of a diacaustic in longitudinal section; (b) physical embodiment of a diacaustic cross-section [18].

(a)

(b)



(a)

(b)

Fig. 3. Longitudinal section of (a) catacaustic and (b) diacaustic [11] being manifestations of coma (comatic aberration) in a parabolic concave mirror and a converging lens. The focus stretches out when the source of rays is situated outside the axis of symmetry.

screen details [8]). Also, K values less than 1 can be found, where reflection is still considered to be specular with much larger component of the scattered energy ($K = 1/3$, [9]).

Apart from the diffraction, the phenomenon of wave interference is also observed in the real acoustic field. Therefore, real focuses and

caustics have a form of an area of a size depending on the wavelength [10]. This work is based on geometrical model and all considerations are valid only for the “optical limiting case”, where focuses are represented by points and cross-sections of the caustics are represented by lines.



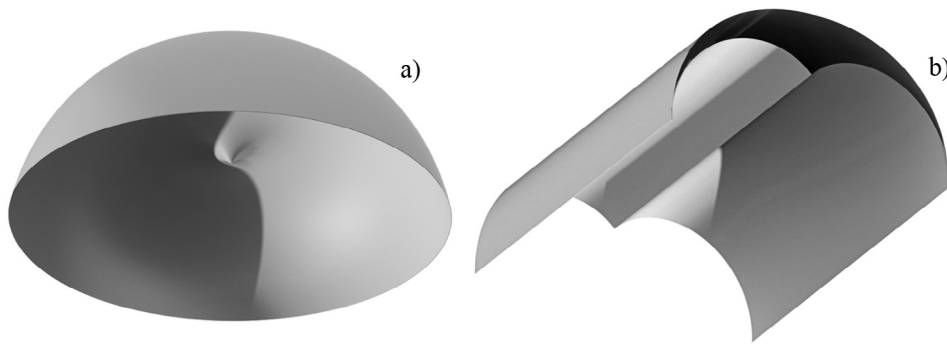

Fig. 4. 3D view of the spherical (a) and cylindrical (b) concave mirror and the caustics formed by the mirrors.

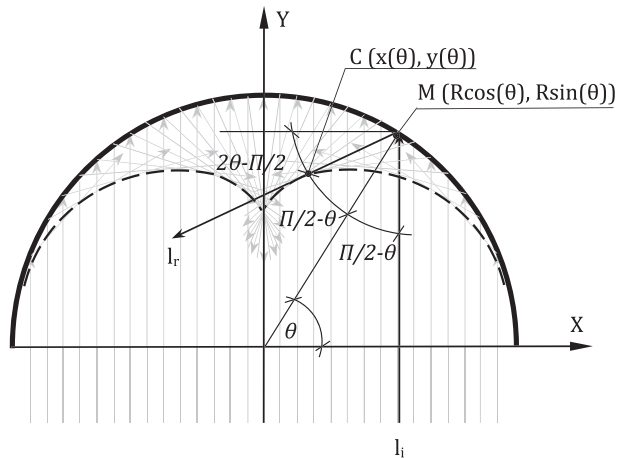

Fig. 5. Reflection of the ray in a cross-section of a concave spherical or hemi-cylindrical mirror (for the details see Fig. 1a). I_i , I_r : the incident and reflected ray; M: the reflection point; C: the point on the caustic; θ : the parameter of the Eqs. (2)–(7).

3. The geometrical nature of a caustic

In geometrical optics, the focus is the point of convergence of rays originating from a definite point and subject to the concentration by optical instruments. In optics, the term “ray” means the direction of light propagation, but it is also applied in other areas like the propagation of sound or electromagnetic waves. If the source of rays is a point in infinity, a bundle of parallel rays is produced.

The focus is a geometric point in only a few cases: when the rays are concentrated by a zero-thickness lens or by a parabolic or elliptical

mirror with the rays source located on its geometrical axis. In other cases, the rays concentrate in a spot of a non-zero size. In optics, the various forms of a blurred focus are known as Seidel aberrations [11]. In addition to the presence of optical devices (e.g. lenses of zero thickness), the reason why radii do not focus at a given point is to cross the boundary between media of different transmission parameters (e.g. air/water, air/glass, layers of air or water of different densities), and even the non-homogeneity of the gravitational field.

A caustic is the envelope to which the reflected, deflected, or refracted rays are tangent and on which concentration of the rays is the highest. It has a form of a surface in three-dimensional space or a curve on its cross-section. A caustic formed as a result of reflections is called the catacaustic, whereas this occurring after refraction or deflection of rays is known as the diacaustic (Figs. 1–3).

Among the fields of technology in which the caustic is considered an important feature, one should count hydroacoustics and aeroacoustics where the caustic-related effects are analyzed in connection with sound propagation in an inhomogeneous [12,13] or non-linear [14] media; the laser technology when laser focus quality is assessed [15]; fiber-optic communication where studies are carried out on light transmission in optic fibers constituting actually cylindrical mirrors [16]. Especially spectacular application of the concept of caustics should be ascribed to astronomy in exploration of the furthest regions of the Universe. The reason for which a caustic develops is a deflection of light emitted by a distant star in the gravitational field of a massive object present between the star and the observer. The field acts as a lens and the image of the star reaching Earth is in fact a cross-section of the caustic formed as a result of the so-called “gravitational lensing” [17].

For the bundle of incident rays as in the Fig. 1a, a 3D view of the caustic formed by the spherical and cylindrical mirror is shown in Fig. 4.

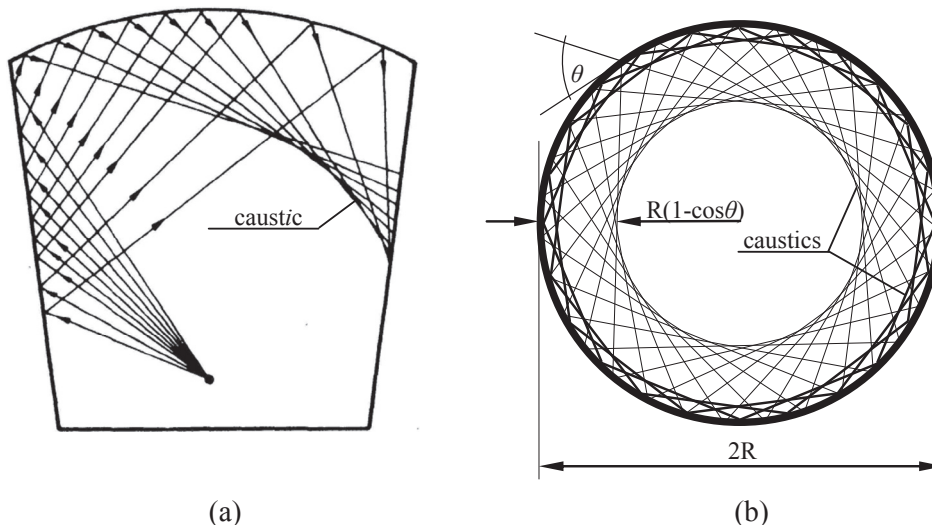

Fig. 6. The mechanism of the caustic formation by single and multiple reflections of sound in the room: (a) an auditorium with a caustic formed as a result of non-axial incidence of sound onto the rear wall [23]; (b) a circular room of the radius R with two concentric caustics formed for different angles θ at which the ray falls on the wall.

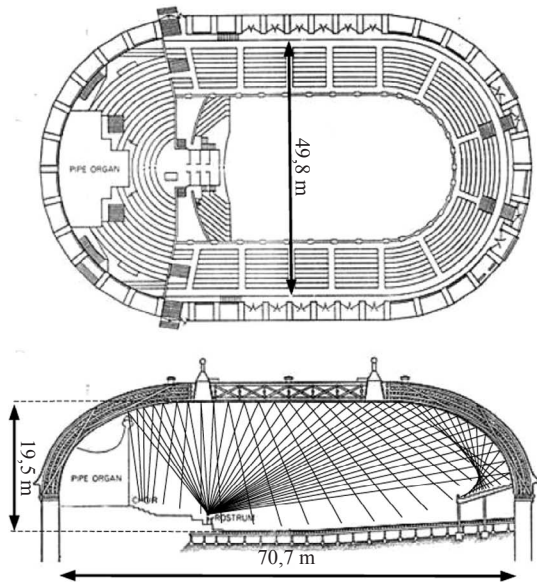

Fig. 7. The Mormon Tabernacle, Salt Lake City, Utah, USA (1869) [24,25]. The lower drawing shows a caustic over the balcony in rear portion of the hall.



Fig. 8. The Whispering Grottoes in Oliwa Park, Gdańsk [27].

4. Analytical representation of the caustic

From among various forms of blurred focuses mentioned above, spherical aberration occurring in the concave spherical mirrors is observed the most frequently [20]. In the following, the derivation of the equation describing the caustic formed by such a mirror is presented [21]. The equation refers to a cross-section of both spherical and hemi-cylindrical mirrors.

The reflected ray l_r (Fig. 5) is described by a straight line $y = ax + b$, where

$$a = \operatorname{tg}(2\theta - \Pi/2) = -\frac{1}{\operatorname{tg}(2\theta)} \quad (2)$$

Since the point M belongs to this line, substituting x and y , respectively, with $R\cos(\theta)$ and $R\sin(\theta)$, yields the coefficient b

$$b = R \left(\sin(\theta) + \frac{\cos(\theta)}{\operatorname{tg}(2\theta)} \right) \quad (3)$$

The equation of the reflected ray l_r is then given by Eq. (4):

$$y(x, \theta) = -\frac{x}{\operatorname{tg}(2\theta)} + R \left(\sin(\theta) + \frac{\cos(\theta)}{\operatorname{tg}(2\theta)} \right) \quad (4)$$

The straight line (4) is tangent to the caustic at the point $C(x(\theta), y(\theta))$, so the variation of the line slope due to a differential change of the

angle θ should tend to zero. Hence, partial derivative of the expression (4) over θ at this point equals zero:

$$\frac{\delta y(x, \theta)}{\delta \theta} = \frac{2x}{\sin^2(2\theta)} + R \left(\cos(\theta) - \frac{\sin(\theta)}{\operatorname{tg}(2\theta)} - \frac{2\cos(\theta)}{\sin^2(2\theta)} \right) = 0 \quad (5)$$

Extracting the variable $x(\theta)$ from Eq. (6) yields

$$\begin{aligned} x(\theta) &= \frac{R}{2} \left(\frac{\sin(\theta) \times \sin^2(2\theta)}{\operatorname{tg}(2\theta)} + \frac{2\cos(\theta) \times \sin^2(2\theta)}{\sin^2(2\theta)} - \cos(\theta) \times \sin^2(2\theta) \right) \\ &= \frac{R}{2} (\sin(\theta) \times \sin(2\theta) \times \cos(2\theta) + \cos(\theta) \times (2 - \sin^2(2\theta))) \\ &= \frac{R}{2} \left(\frac{1}{2} \sin(4\theta) \times \sin(\theta) + \cos(\theta) \times (2 - \sin^2(2\theta)) \right) \end{aligned} \quad (6)$$

The set of Eqs. (7) and (4) $\{x(\theta), y(\theta)\}$ describes the cross-section of the caustic formed by a spherical or hemi-cylindrical concave mirror.

5. Caustics in room acoustics

Historic interiors are frequently formed by vaults, walls built on a curvilinear groundplan, or they comprise other large scale elements that represent curved surfaces, which show a tendency to concentrate sound. Usually it is assumed that such concentrations take the form of a point-like focus. But this happens only when the mirror is a sector of a paraboloid or ellipsoid and when the sound source is situated on the geometric axis or, respectively, in the geometrical focus of the mirror. In real rooms, these conditions are usually not met. Curvatures of walls and vaults are designed according to the requirements of the building construction and may take the form of a paraboloid sector only by chance. Moreover, moving sound sources, such as people or musical instruments, can find themselves on symmetry axes of these curved features only accidentally. For these reasons, sound energy concentrations in rooms typically take the form of a caustic.

Fig. 6 presents two different forms of the ray concentration by a curved wall. Fig. 6a shows a schematic plan of an auditorium with a caustic in the audience area. The rays concentration is a result of non-axial incidence of sound onto the curved wall. As the even distribution of sound level over the audience is one of key acoustic criteria in a room, sound concentration is an unfavorable phenomenon here.

Fig. 6b shows a horizontal section of a room constructed on a circular plan. An example of such a building is the St. Paul's Cathedral in London, the upper portion of which has a form of a round gallery. Due to its cylindrical form, the visitors occupying the gallery can hear each other. Remaining on the grounds of the ray-based model, this is a result

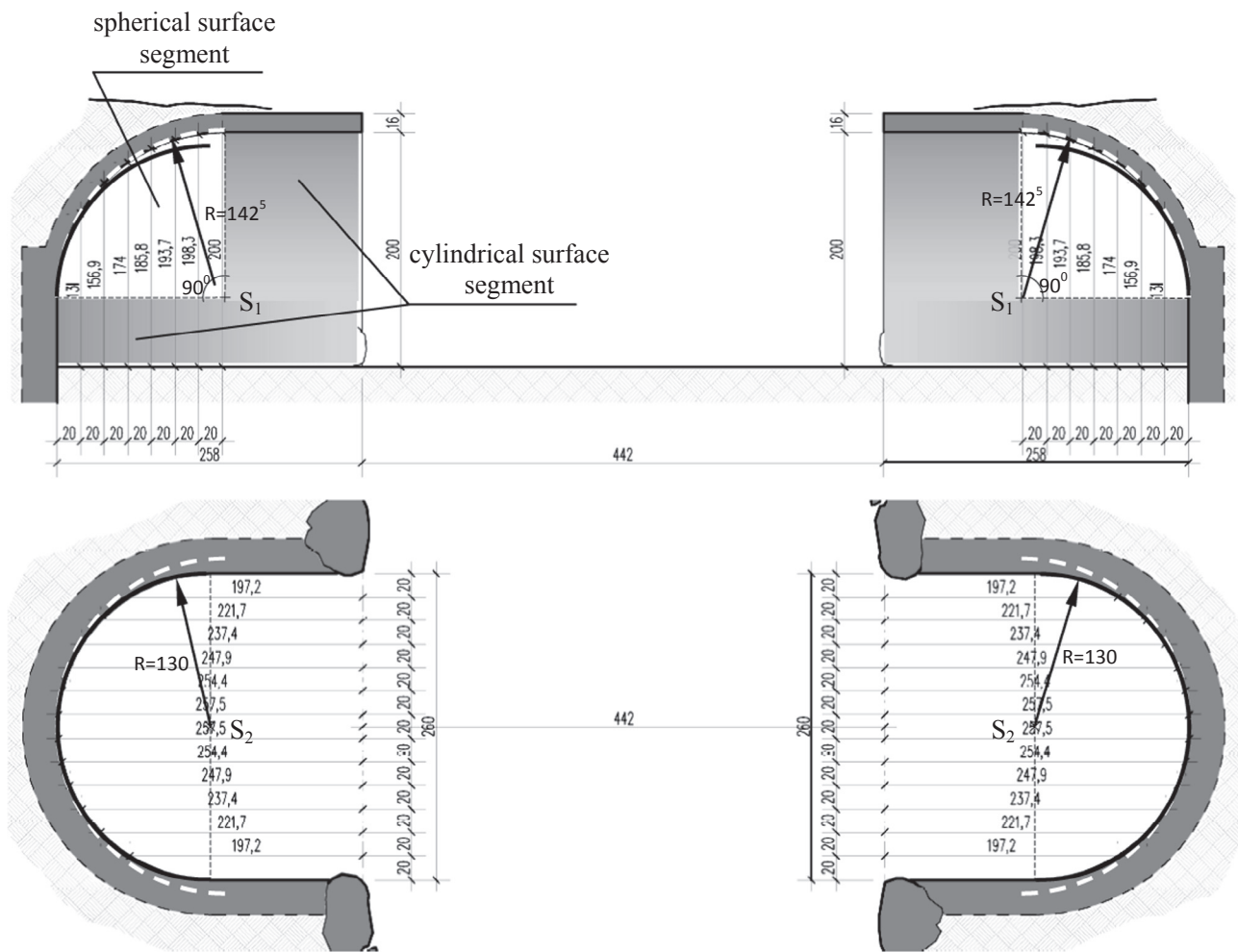

Fig. 9. Vertical and horizontal cross-section of the Whispering Grottoes. The dashed line and the solid line mark curvatures in vertical and horizontal cross-section of the spherical part of the grotto, respectively, with S_1 and S_2 marking centers of curvature ($S_1 \neq S_2$).

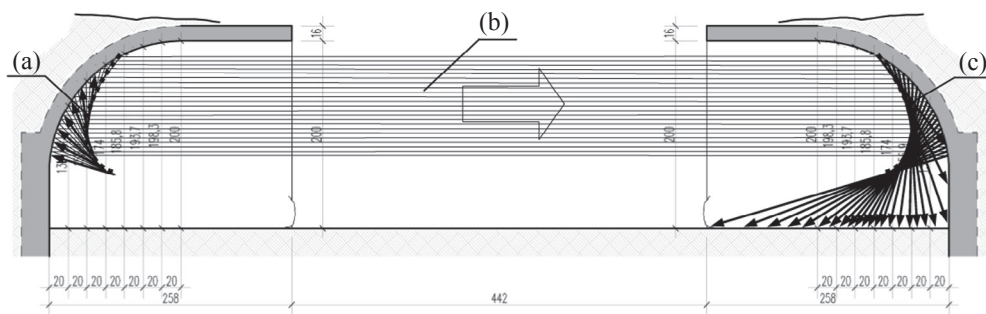

Fig. 10. Vertical section of the Whispering Grottoes in Oliwa Park: (a) the source caustic; (b) the bundle or parallel rays; (c) the receiving caustic.

of an overlay of several concentric caustics situated close to each other.

For the range of the medium and high frequencies important for the speech intelligibility, directivity index of the human mouth is about 4 dB [22]. In this range, human mouth is then a directional source of sound, which in the ray-based model can be represented by a point emitting a bundle of rays concentrated around the specified direction. In the considered example, this direction is approximately tangent to the curved wall. Each ray creates then a concentric caustics, two of which are shown in Fig. 6b. At given angle θ , the distance d between the caustic and the wall equals to [1]

$$d = R(1 - \cos\theta), \quad (7)$$

where R is the radius of the cylinder defining the wall surface. The effect of the sound reinforcement arises from the overlap of several

caustics of the values d that differ so little that they cover the human head.

It should be noted that Fig. 6b is only a geometric model of the “whispering gallery” effect. In the physical sound field, the wave front is not a plurality of rays but constitutes a continuum. The above-mentioned family of caustics has therefore rather the form of a blurred ring than a plurality of separate circles.

Fig. 7 shows the Mormon Tabernacle in Salt Lake City, USA, as an example of using an existing caustic to improve audibility in a part of the hall the most distant from the speaker. The caustic is a result of sound reflection from the rear portion of the ceiling constituting a concave acoustic mirror. Before the balcony was constructed, the sound focused by the mirror was falling on the ground floor auditorium. This resulted in large surface covered by sound. Once the balcony of suitable

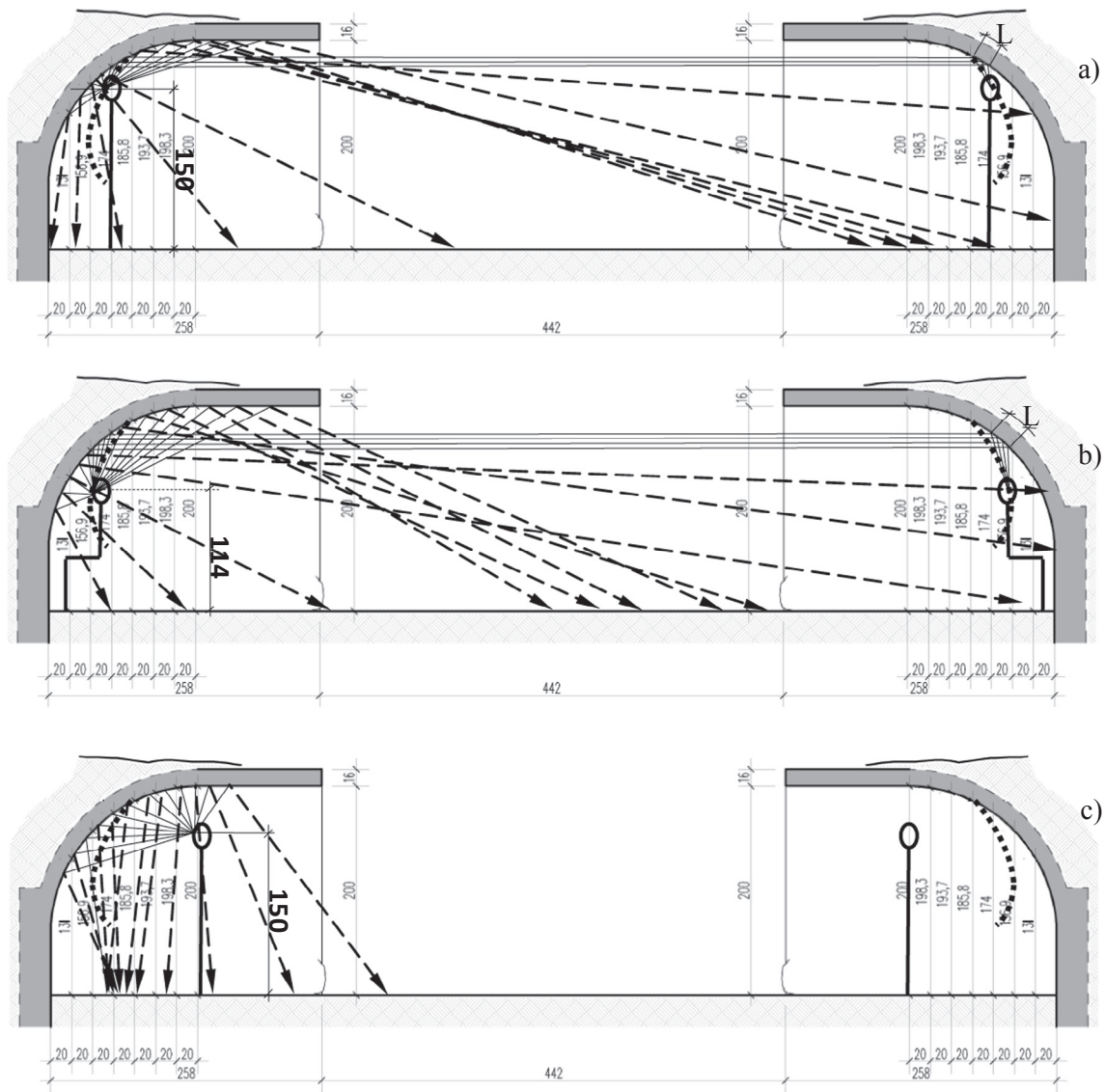

Fig. 11. Sound rays in the vertical cross-section of Whispering Grottoes at the present ground level: (a), (b)—the speaker and the listener situated on their caustics, experiencing the weaker and the stronger effect of sound focusing, respectively; “L”—the relevant sound-focusing segment of the acoustic mirror; (c)—the speaker and the listener situated outside the caustics, without the effect of sound focusing. Dashed lines represent the rays which do not take part in formation of the sound focusing effect.

height was added, the same flux of acoustic energy falls onto a surface of significantly smaller area. This improved audibility on the balcony [26].

6. A case study—the Whispering Grottoes in Gdańsk Oliwa Park

6.1. Description of the structure

The Whispering Grottoes belong to a group of well-preserved components of the eighteenth-century landscape park in Gdańsk-Oliwa. The structure comprises two symmetrical oval grottoes built opposite each other, meant as an attraction serving outdoor demonstration of the laws of acoustics (Fig. 8). If two persons stand in the grottoes back to back, they are able to hear each other quite well even if they whisper. Before starting a renovation project covering the grottoes and a park alley between them, it became necessary to check whether this effect will reappear after restoration.

Each of the grottoes is composed of a $\frac{1}{4}$ of a sphere and its extension in the form of two segments of cylindrical surfaces. One segment can be found between the spherical part of the grotto and the ground, while the second one is situated at the entrance of the grotto (Fig. 9). The

spherical sections are slightly distorted—their vertical and horizontal cross-sections constitute the semicircles of the radii 142.5 cm and 130 cm, respectively (dashed and solid lines in Fig. 9).

6.2. The mechanism of sound amplification in the Whispering Grottoes

In terms of acoustics, the Whispering Grottoes represent a symmetric system of two spherical mirrors. Sound rays incoming from the source mirror are concentrated in the receiving mirror, what creates the effect of amplification (Fig. 10). As can be seen from Fig. 1a, this effect is a result of spherical aberration typical for concave spherical mirrors.

Apart from the caustic formed by rays incoming to the receiving mirror, a caustic formed in the source mirror can be also identified. For the purpose of the present study, these two caustics will be referred to as the “receiving caustic” and the “source caustic”. In analogy to the receiving caustic, the source caustic is an envelope of rays, emitted by omnidirectional sources with definite locations. After the reflection, these rays form a bundle of parallel rays. “Definite locations” means the geometric locus of potential locations of such sources (Fig. 10a).

Aurally perceptible amplification of sound occurs when the speaker and the listener are situated on symmetrical fragments of the source and

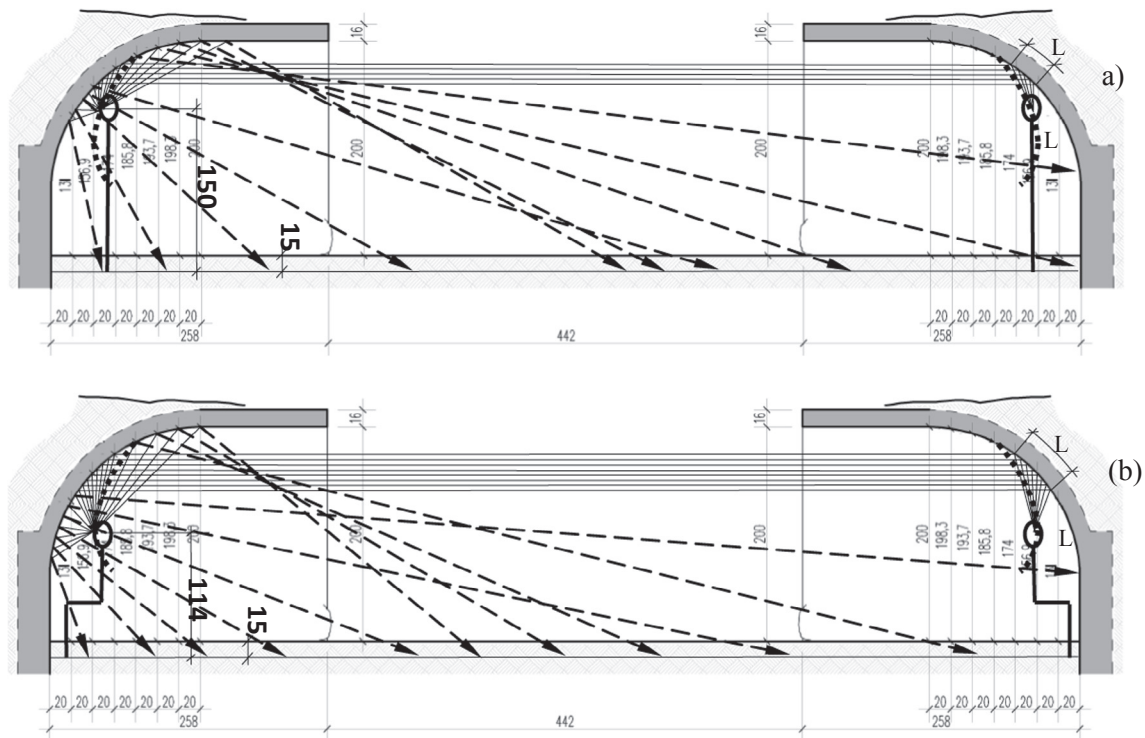

Fig. 12. Sound rays in the vertical cross-section of the Whispering Grottoes for (a) standing and (b) sitting position of both speaker and listener. Sound focusing occurs with higher intensity with the ground level lowered by 15 cm; the length of segment “L” increases in comparison with this of Fig. 11a and b.



(a)



(b)

Fig. 13. Position of the speaker consistent with form of the source caustic—just in front of and facing the wall: (a) Alhambra palace complex in Granada, Spain (1232–1273), The Hall of Secrets [29]; (b) Grand Central Terminal in New York (1871–1913) [30].

receiving caustic, respectively (Figs. 11a, b, and 12). When the head of either the speaker or the listener is positioned outside their respective caustic, the sound amplification effect disappears (Fig. 11c).

As the energy of focused sound is stretched out in the form of the caustic, the sound amplification effect becomes weaker than it would be in the case of a point focus, because only a portion of the mirrors surface takes part in sound focusing. The size of the sound focusing surface depends on position of speaker and listener on the caustic (see segments denoted “L” in Figs. 11a, b, and 12). With increasing area of this surface, the sound amplification level also increases and therefore it is possible to determine such position of the speaker and the listener, for which the sound amplification effect reaches its maximum. This position corresponds to the caustic cusp, where the concentration of rays forming the caustic is the strongest. This follows from both geometrical analysis of the caustic forming process (Figs. 1a and 10c) and experimental studies concerning technical applications of spherical mirrors

[21].

Between two spherical acoustic mirrors representing a symmetric system, a flutter echo may occur. Such effect is created when both the source and the receiver of sound are located on the axis of symmetry of the system. In the case of the Whispering Grottoes, it is a straight line passing through the cusps of the caustics. When both the speaker and the listener are outside this line, as in the case considered in this paper, the flutter echo is not formed.

6.3. Historical remarks

Taking into account the positions of caustics in relation to inner surfaces of the grottoes, it must be assumed that the designer of the grottoes considered the ergonomic aspect of the structures. He had to predict that a visitor could place his/her mouth in proper location and then, taking into account the average height of a person, adopt an

great competence of architects of that time in the field of acoustics.

References

- [1] Strutt JW, Rayleigh Baron. Whispering galleries. In: The theory of sound, vol. II. London - New York: Macmillan and Co., Ltd.; 1896 <https://archive.org/details/theoryofsound02raylrich> [30.12.2016] [chapter XIV, § 287].
- [2] Strutt JW, Rayleigh Baron. The problem of the whispering gallery. Philosophical magazine, vol. XX; 1910, p. 1001-4. In: Scientific papers, vol. V. Cambridge: University Press; 1912. p. 1902-10 < <https://archive.org/stream/scientificpapers05rayliala#page/n637/mode/1up> > [30.12.2016, Art. 348].
- [3] Raman CV. On whispering galleries. In: Proc. Indian Ass. Cultiv. Sci. 7; 1922. p. 159-72 < <http://repository.ias.ac.in/69841/1/69841.pdf> > [30.12.2016].
- [4] Sabine WC. Whispering galleries. In: Collected papers on acoustics. Cambridge: Harvard University Press; 1922 [chapter 11] < <https://ia902705.us.archive.org/22/items/collectedpapers00sabi/collectedpapers00sabi.pdf> > .
- [5] Schmidt RF. Analytical caustic surfaces. NASA Technical Memorandum 87805. NASA Technical Reports Server; April 1987. < <https://ntrs.nasa.gov/archive/nasa/casi.ntrs.nasa.gov/19880001678.pdf> > [20.07.2016].
- [6] Kulowski A. Mirror reflection. In: Akustyka sal. Zalecenia projektowe dla architektów (Acoustics of Halls. Design recommendations for architects, in Polish). Gdańsk: Wydawnictwo Politechniki Gdańskiej; 2011 [chapter 1.4.1].
- [7] Puzyna Cz. Acoustic screens. In: Zwalczanie hałasu w przemyśle – zagadnienia wybrane (Noise Control in Industry – Selected Issues, in Polish). Warszawa: WNT; 1974 [chapter 5.1.].
- [8] Egan MD. Reflection, diffusion and diffraction. In: Concepts in architectural acoustics. New York: McGraw-Hill Book Company; 1988. p. 89-90.
- [9] Sadowski J. Surfaces directing the first reflection. Sound diffusing elements. In: Akustyka w urbanistyce, architekturze i budownictwie (Acoustics in urban planning, architecture and construction, in Polish). Warszawa: Arkady; 1971 [chapter 18.2.3].
- [10] Kuttruff H. Some remarks on the simulation of sound reflection from curved walls. *Acustica* 1993;77:176-82.
- [11] EF LENS WORK III. Canon Inc. Lens Products Group; 2006. < http://software.canon-urope.com/files/documents/EF_Lens_Work_Book_10_PL.pdf > [20.07.2016].
- [12] Percell BC. The effect of caustics in acoustics. inverse scattering experiments. PhD dissertation. Houston, Texas: Rice University; 1989. < <http://www.caam.rice.edu/caam/trs/89/TR89-03.pdf> > [20.07.2016].
- [13] Beron-Vera FJ, et al. Ray dynamics in a long-range acoustic propagation experiment. *J Acoust Soc Am* 2003;114:1226-42.
- [14] McDonald BE, Kuperman WA. Time domain formulation for pulse propagation including nonlinear behavior at a caustic. *J Acoust Soc Am* 1987;81:1406-17.
- [15] Baraniecki T, et al. System laserowego mikronapawania proszków metali (System for laser microcladding of metal powders, in Polish). *Przegląd Spawalnictwa* 9/2011. < <http://www.pspaw.pl/index.php/pspaw/article/viewFile/505/510> > [20.07.2016].
- [16] Patela S. Zasada działania, właściwości i parametry światłowodów (Principle of operation, properties and parameters of optical fibers, in Polish); 2013. < <http://www-old.wemif.pwr.wroc.pl/spatela/pdfy/0020.pdf> > [20.07.2016].
- [17] Skowron J. Analiza niestandardowych zjawisk mikroszczekowania grawitacyjnego gwiazd Galaktyki. Rozprawa doktorska (Analysis of non-standard phenomena of gravitational microlensing of galactic stars. PhD dissertation, in Polish). Uniwersytet Warszawski; 2009. < <http://www.astrouw.edu.pl/~jskowron/PhD/thesis/phd.pdf> > [20.07.2016].
- [18] Jankowski LJ. Wyznaczenie współczynnika napiętności metodami optycznymi – materiały pomocnicze (Determination of the stress intensity factor by optical methods, in Polish); 2011. < <http://www.biomech.pwr.wroc.pl/wp-content/uploads/2016/09/pdcw14.pdf> > [20.07.2016].
- [19] WIKIPEDIA; 2015. < https://en.wikipedia.org/wiki/Caustic_%28optics%29 > [20.07.2016].
- [20] Kuttruff H. Enclosures with curved walls. In: Room acoustics. London – New York: Spon Press; 2000 [chapter 4.4]. < <https://danylastchild07.files.wordpress.com/2016/05/room-acoustics-kuttruff.pdf> > [12.04.2017].
- [21] Castagnede B, et al. Cuspidal caustic and focusing of acoustical waves generated by a parametric array onto a concave reflecting surface. *C. R. Mecanique*, 337; 2009 < http://perso.univ-lemans.fr/~vtourant/wa_files/CRCastagnede2009.pdf > [20.07.2016].
- [22] Steward K, Cabrera D. Effect of acoustic environment on the sensitivity of speech transmission index to source directivity. *Acoustics 2008*, Geelong, Victoria, Australia, Nov. 2008. p. 26-8. < https://www.acoustics.asn.au/conference_proceedings/AAS2008/papers/p43.pdf > [07.05.2017].
- [23] Rettinger M. Acoustic design and noise control vol. 1. New York: Chemical Publishing Co.; 1977.
- [24] Mormon Tabernacle; 2012. < http://www.engineergirl.org/what_engineers_do/FunFacts/MormonTabernacle.aspx > [20.07.2016].
- [25] HYPERPHYSICS. Georgia State University. HyperPhysics, Sound and Hearing; 2016. < http://vnsound.tripod.com/snarchi/snarchi_3.html > [20.07.2016].
- [26] Esplin SC. Introduction to *The Tabernacle*: “An Old and Wonderful Friend”. Provo, UT: Religious Studies Center, Brigham Young University; 2007. p. 11-63. < <https://rsc.byu.edu/archived/tabernacle-old-and-wonderful-friend/introduction> > [20.07.2016].
- [27] BLOG; 2015. < <https://tereska12045.flog.pl/archiwum/albumy/232073/trojmiasto/> > [20.07.2016].
- [28] WIKIPEDIA; 2016. < https://pl.wikipedia.org/wiki/Park_Oliwski > [20.07.2016].
- [29] BLOG; 2012. < <http://rositadearboleas.blogspot.com/2012/06/la-sala-de-los-secretos.html> > [20.07.2016].
- [30] Metropolitan Transportation Authority; 2012. < <http://www.mta.info/news/2012/10/30/whispering-gallery-renovations-complete> > [20.07.2016].