

Ewa PIĄTKOWSKA*

EVALUATING THE INFLUENCE OF BENDING STRESS ON A 1H18N9 STEEL SHAFT WEAR PROCESS IN A WATER LUBRICATED SLIDING BEARING WITH A RUBBER BUSHING

OCENA WPŁYWU NAPRĘŻEŃ ZGINAJĄCYCH NA PROCES ZUŻYCIA CZOPA ZE STALI 1H18N9 W SMAROWANYM WODĄ ŁOŻYSKU ŚLIZGOWYM Z GUMOWĄ PANWIĄ

Key words:

sliding bearings, shaft journal, water lubricated, bending stress.

Abstract

The issue of excessive wear of shaft journals co-working with a rubber bearing has been unexplained so far. Premature and sometimes very intensive wear of ship sliding bearings in water conditions is the reason for carry out very expensive and more frequent than expected repairs. The authors (E. Piątkowska, W. Litwin) made an attempt to find a case that influences the value of this wear described in the paper "Attempt at Evaluating the Influence of Bending Stress on Shaft Wear Process in Water Lubricated Sliding Bearing with Rubber Bush" (TRIBOLOGY 1/2017). These studies, however, did not explain the dependency of the wear process but showed how to progress further to find the answer to the question about the effect of bending stress on shaft wear. The research is continued on a modified test stand, and their results are presented in this paper. The profilographometer was used to evaluate the wear of the journal shaft. To compare wear intensity, roughness profiles have been 'removed' from the journals both before and after co-operation. They were compared in terms of bending stresses and bending moments.

Słowa kluczowe:

łożyska ślizgowe, czop wału, smarowanie wodą, zużycie, naprężenia zginające.

Streszczenie

Problematyka nadmiernego zużycia czopa wału współpracującego z gumową panwią łożyska ślizgowego jest jak dotąd niewyjaśniona. Przedwczesne, czasem bardzo intensywne zużycie okrętowych łożysk ślizgowych pracujących w środowisku wodnym staje się powodem przeprowadzania bardzo kosztownych i częstszych niż zakładano remontów. Autorzy (E. Piątkowska, W. Litwin) podjęli próbę znalezienia przyczyny wpływającej na wielkość tego zużycia opisaną w referacie: „Próba oceny wpływu naprężeń zginających na proces zużycia czopa w smarowanym wodą łożysku ślizgowym z gumową panwią” (TRIBOLOGIA, wydanie 1/2017 „Attempt at Evaluating the Influence of Bending Stress on Shaft Wear Process in Water Lubricated Sliding Bearing with Rubber Bush”). Badania te jednak nie wykazały zależności opisującej proces zużycia, ale wskazały, w jaki sposób należy kontynuować dalsze prace, aby znaleźć odpowiedź na postawione pytanie dotyczące wpływu naprężeń zginających na stopień zużycia czopa wału. Prace badawcze są kontynuowane na zmodyfikowanym stanowisku pomiarowym, a ich wyniki przedstawione zostały w niniejszym referacie. Do oceny stanu zużycia czopów wałów, które współpracowały z gumową panwią wykorzystano profilografometr. Dla porównania stopnia zużycia profile chropowatości zostały 'zjęte' z czopów zarówno przed, jak i po współpracy. Porównywane były one pod względem naprężeń zginających, jak i momentów gnących.

INTRODUCTION

Water lubricated stern bearings that have been used in shipbuilding have gone through numerous transformations involving, inter alia, material used on bushings. Their development began in the mid-nineteenth century, when a Great Eastern steamer mounted white-metal bearings that were abruptly worn and replaced by wooden bushings [L. 1, 2].

The following years brought with it the development of new materials. Then bearings and bushings were developed with natural rubber, then synthetic (NBR), and a variety of other composite materials that were, polymer or ceramic [L. 3]. However, from all the materials used so far, rubber bushings are still very popular, which is characterized by reduced susceptibility to high wear due to misalignment of the shaft relative to the bushing, vibration damping ability, and a relatively low cost.

* Gdańsk University of Technology, Faculty of Ocean Engineering and Ship Technology, ul. Gabriela Narutowicza 11/12, 80-233 Gdańsk, Poland, e-mail: ewapiatk@pg.edu.pl.

In literature, repeatedly attempts were made to formulate a suitable mathematical relationship that would describe the problem of premature wear of shaft journals in water-lubricated bearings with rubber bushings [L. 4–6]. Experience in cooperation with Shipyards shows that, with close, low surface pressure and rubbing speeds, there is occasionally excessive wear of the shaft that cooperates with the rubber bushing. The reasons of this wear are not known. Therefore, further experimental attempts have been made to explanation this phenomenon, which is a continuation of the study carried out in the previous article [L. 2]. Repeatedly, the causes of uneven wear of the journal shaft have been investigated during lubrication of rubber bearings with water [L. 7–11], and the accompanying mechanisms of material transfer in the steel-rubber friction pair [L. 12] rely on breaking down the intermolecular bonds and replenishing the cavities from bushing to the journal shaft under the influence of heat, and chemical and mechanical processes. These processes may have been caused by the type and quantity of friction, stress accumulation, and atmospheric and particulate impacts [L. 12].

TEST STAND

A test stand for the ship's shaft wear test carried out in the first series (Fig. 1) [L. 2] was slightly modified. However, the working principle has been maintained.

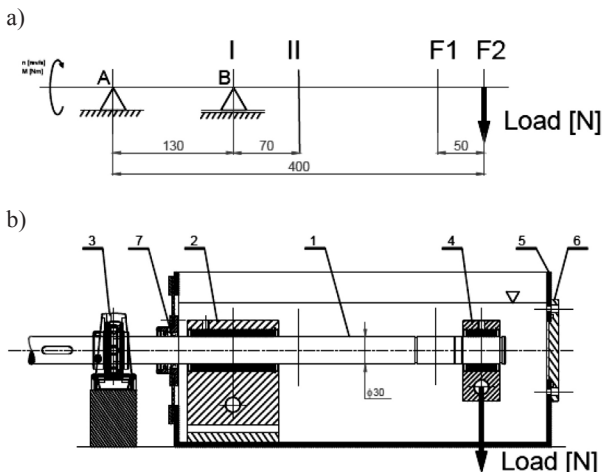

Fig. 1. Test stand: a) test stand diagram, b) test stand cross-section: 1 – shaft, 2 – support of tested bearing, 3 – rolling bearing, 4 – sliding bearing through which load is applied, 5 – tank filled with water, 6 – cover, 7 – seal

Rys. 1. Stanowisko pomiarowe a) schemat stanowiska, b) przekrój przez stanowisko: 1 – wał, 2 – podpora badanego łożyska, 3 – łożysko toczne, 4 – łożysko ślizgowe, za pośrednictwem którego wywierane jest obciążenie, 5 – zbiornik wypełniony wodą, 6 – pokrywa, 7 – uszczelnienie

An electric motor drives the shaft (1) on which the sliding bearings with the rubber bushings (2 and 4) are mounted. Both of these bearings are submerged in a water tank to provide constant lubrication and cooling. The modification of the test stand consists in replacing the rigid, bipartite support of the bearing (2) with the self-adjusting support (8) (Fig. 2) to ensure shaft alignment with the support and to install an additional tank (9) to circulate water in the closed loop (10) which is pumped (11) into the main tank, while its temperature rises only a few degrees above the ambient temperature and does not exceed 30°C (Fig. 3).

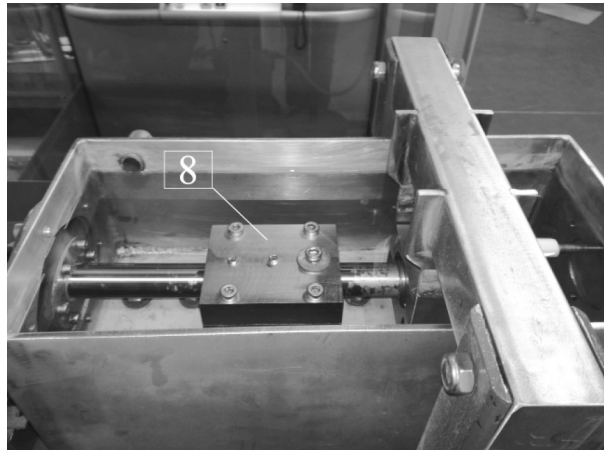

Fig. 2. A self-adjusting support of the bearing in housing (8) in position II

Rys. 2. Podpora wahlwiwa badanego łożyska w oprawie (8) w pozycji II

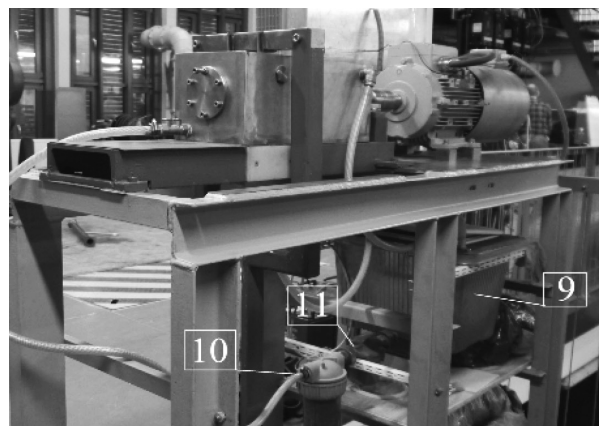

Fig. 3. Modified test stand: 9 – additional tank, 10 – filter, 11 – pump

Rys. 3. Zmodyfikowane stanowisko pomiarowe: 9 – dodatkowy zbiornik, 10 – filtr, 11 – pompa

That constructed stand allows the elimination of the causes of errors that appeared in the first measurement series by achieving the following:

- The water in the main tank is cleaned so that the solid particles do not get into the grooves of the bushing and did not affect the wear of the shaft journal.



- Continuous water circulation facilitates the maintenance of its constant temperature,
- Using the self-adjusting support causes the shaft to move freely in the support during bending.

RESEARCH METHOD

The tests were carried out on the test stand (Figs. 1–3) in conditions similar to those in the highly loaded ship stern tube bearing. Because of the design and construction of the test stand, it is possible to apply the bending load of the journal bearing in a controlled way.

The material of the shaft is typical high alloy steel (chromium-nickel 1H18N9) used for ship's shafts, with acceptable bending stresses (depending on the yield strength R_e) in the range of 120–170 MPa. The mass suspended on the shaft is 51.7 kg.

For the evaluation of the impact of bending stress on shaft wear process, it was assumed that all of the bearings would be tested in the same conditions for each pair of bearings. The main assumptions are as follows:

- The same surface pressure is maintained in both bearings.
- There are equal working times and the same number of engine starts.

Application of hollow shafts (measurements 5 and 6) and the change of the length of the bushing in position B (positions I and II), while maintaining the constant length of the bushing F (F1 and F2), allow for achieving different bending stresses while maintaining equal surface pressure (Table 1).

EXPERIMENTAL RESEARCH

Testing each pair of bearings lasted 70 hours. The engine speed was 600 rpm for the first 14 hours, and then it was increased to 1000 rpm. The lengths of the bushings

and their positions are shown in the measurement table (Table 1) and the test stand diagram (Figure 1).

After 70 hours of working, the test stand was dismantled and the shaft was cut into samples to identify the bearing journal wear intensity. The examined journal shafts are shown in Fig. 4 in the order shown in Table 1.

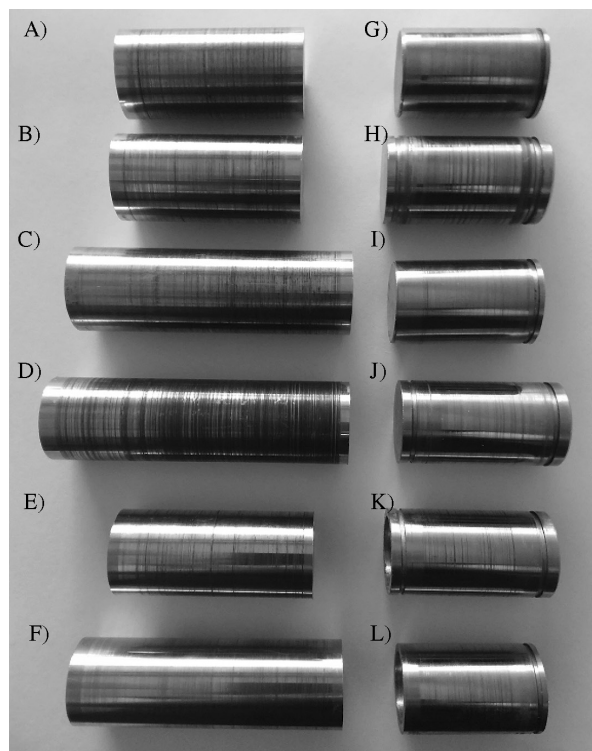

Fig. 4. Cut journal shafts after research
Rys. 4. Czopy wałów wycięte po badaniach

The roughness profile of each shaft was recorded using a profilographometer. For each pair of bearings, these measurements were also made before the test to compare the intensity of wear each sample.

Table 1. Measurement table

Tabela 1. Tabela pomiarowa

no.	indication	DATA			Reaction		Bending		Pressure	
		bush length B	bush length F	position of support B and application of force F	A	B	bending moment	bending stresses	in tested bearing (B)	in the load applying bearing (F)
-	-	mm	mm	-	N	N	Nm	MPa	MPa	MPa
1	A – G	50	28	II, F1	412,02	961,38	82,40	32,55	0,641	0,654
2	B – H	57	28	II, F2	549,36	1098,72	109,87	43,41	0,643	0,654
3	C – I	77	28	I, F1	929,69	1479,05	120,86	47,75	0,640	0,654
4	D – J	87	28	I, F2	1140,98	1690,34	148,33	58,60	0,648	0,654
5	E – K	57	28	II, F2	549,36	1098,72	109,87	73,52	0,643	0,654
6	F – L	77	28	I, F1	929,69	1479,05	120,86	80,87	0,640	0,654

SELECTED ROUGHNESS PARAMETERS

The data profiled by the profilographometer is presented graphically in the form of roughness profiles. They represent the journal shafts before and after measurements (in accordance with the order given in **Table 1** and **Figure 4**). Before measuring, the shafts were spotted and profiled, and the same measurements were made at the same locations. Roughness profiles prior to testing for each journal look the same, so only

one sample (example G) is shown in the illustration for a smooth profile.

The presented profiles indicate that the wear of the journal shaft (Samples A-F) is $30\ \mu\text{m}$, except for Sample D ($60\ \mu\text{m}$). However, for the first 4 samples, there is some dependence that distorts the results for the hollow shaft.

Rubber is a relatively soft material; therefore, in the friction pair of steel-rubber under favourable conditions (water, temperature, soiling), the material of bushing can be transferred to the journal shaft, as can be seen in Example D.

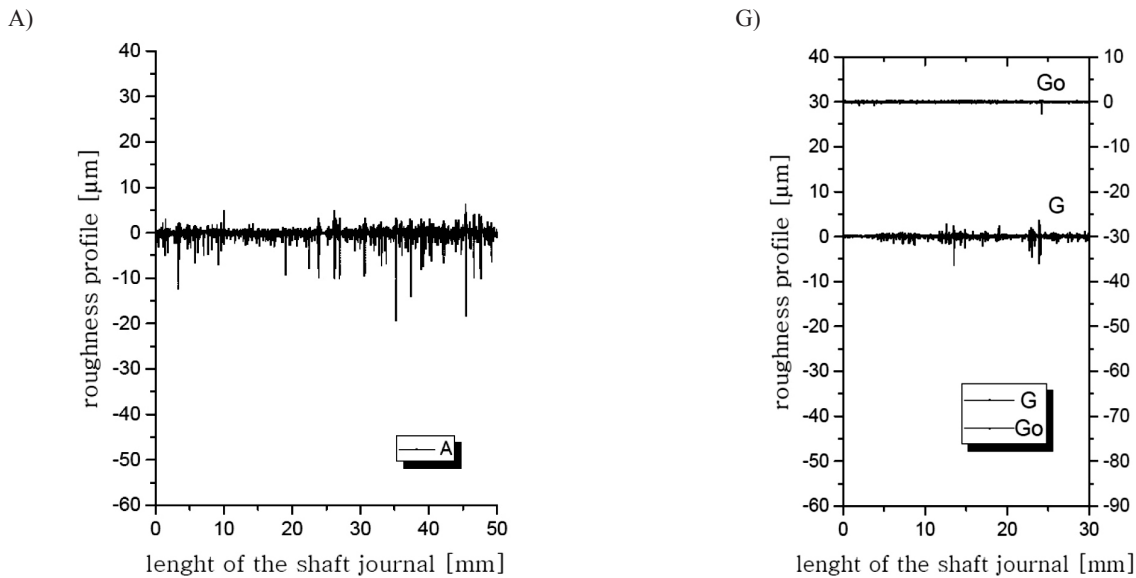

Fig. 5. Roughness profiles from the first measurement (Figs. 4A and 4G)

Rys. 5. Profile chropowości próbek z pomiaru pierwszego (Rys. 4A i 4G)

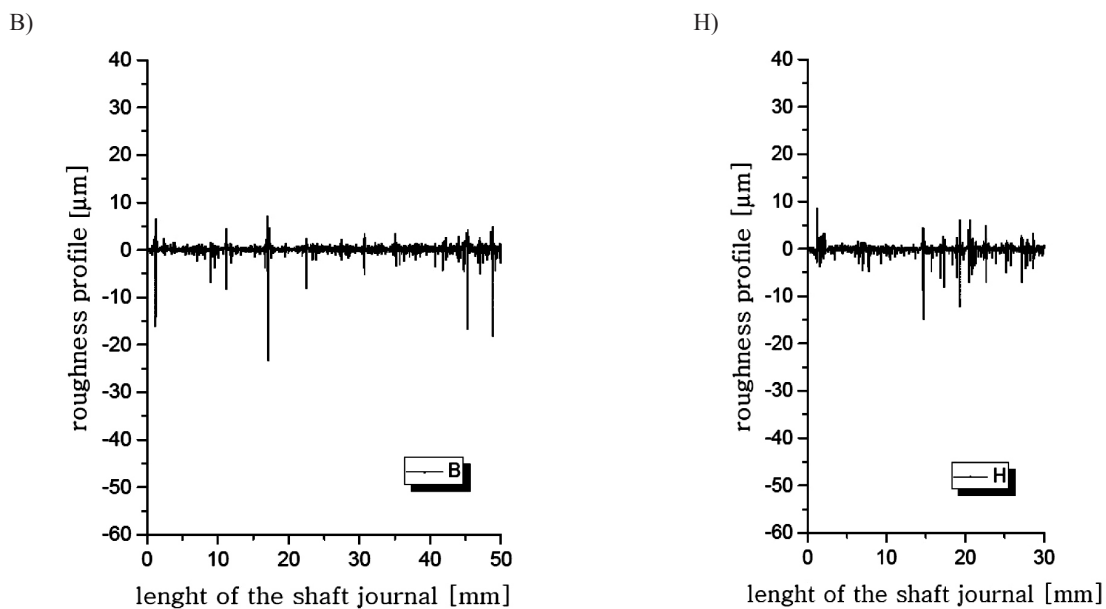

Fig. 6. Roughness profiles from the second measurement (Figs. 4B and 4H)

Rys. 6. Profile chropowości próbek z pomiaru drugiego (Rys. 4B i 4H)

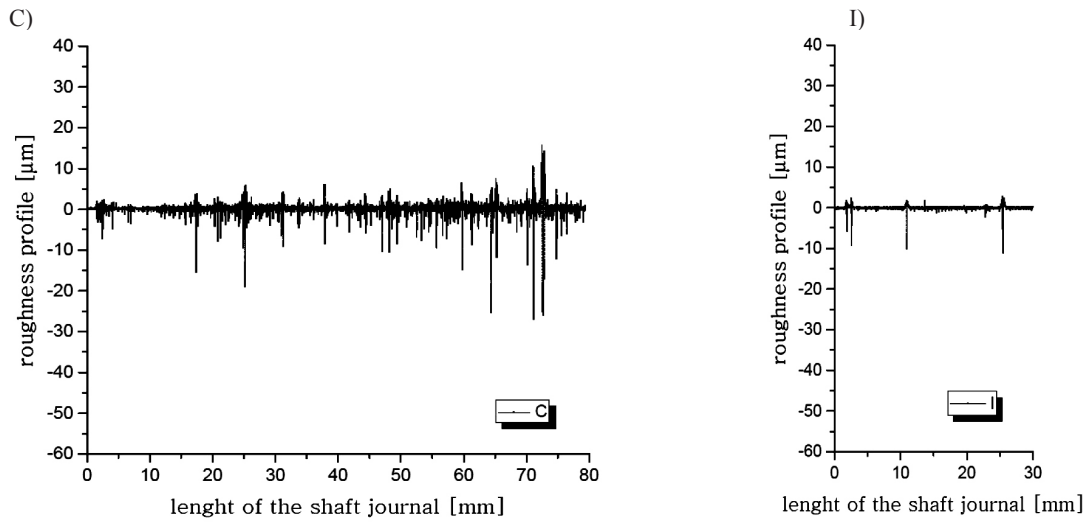

Fig. 7. Roughness profiles from the third measurement (Figs. 4C and 4I)

Rys. 7. Profile chropowości próbek z pomiaru trzeciego (Rys. 4C i 4I)

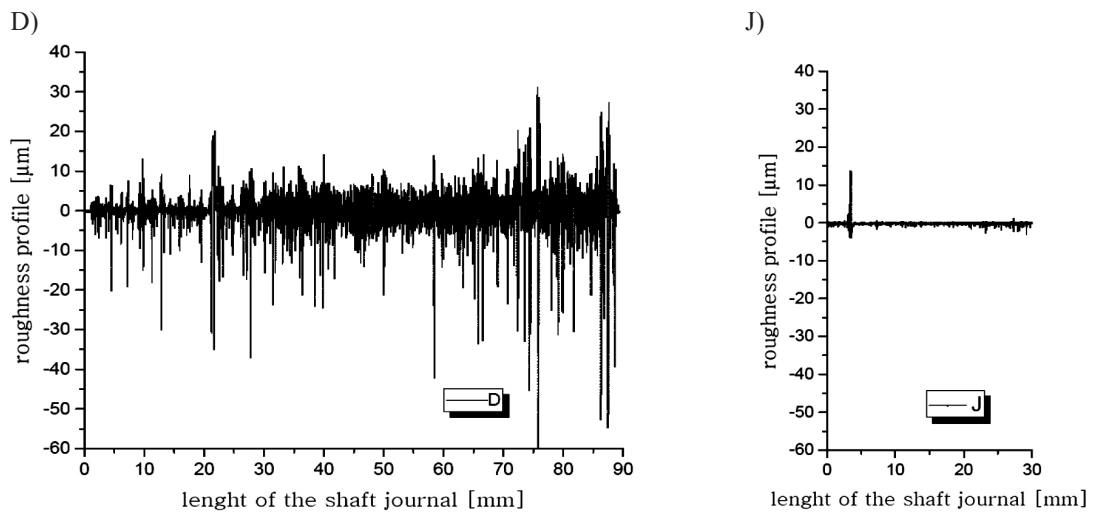

Fig. 8. Roughness profiles from the fourth measurement (Figs. 4D and 4J)

Rys. 8. Profile chropowości próbek z pomiaru czwartego (Rys. 4.D i 4J)

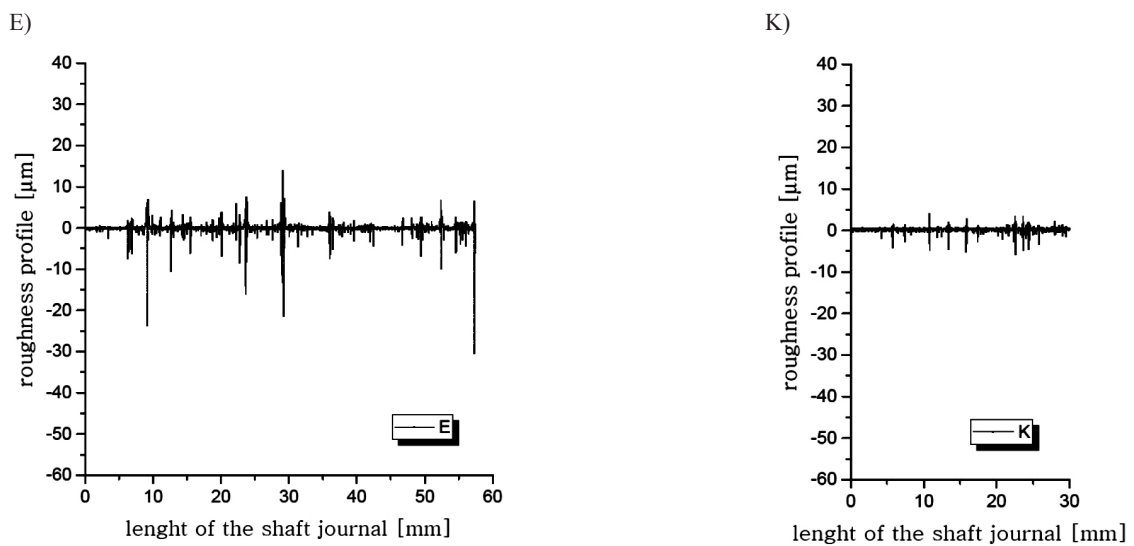

Fig. 9. Roughness profiles from the fifth measurement (Figs. 4E and 4K)

Rys. 9. Profile chropowości próbek z pomiaru piątego (Rys. 4E i 4.K)

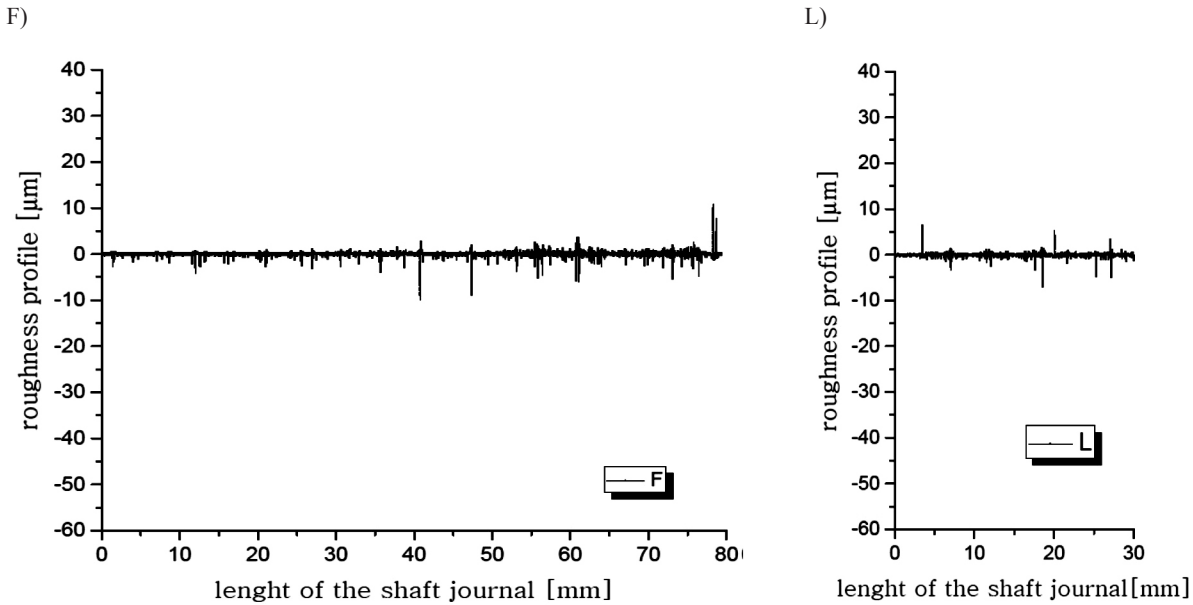

Fig. 10. Roughness profiles from the sixth measurement (Figs. 4F and 4L)

Rys. 10. Profile chropowatości próbek z pomiaru szóstego (Rys. 4.F i 4L)

CONCLUSIONS

The hypothesis that the bending stresses affect the wear process of the journal shaft has not been confirmed. It was expected that the wear would be proportional to the bending moment of the shaft. Such dependence on the basis of realized measurements, however, is difficult to see. But we cannot definitely exclude that possibility, because the bearings work in virtually identical conditions (rubbing speed and surface pressure), and the amount of wear is significantly different. After the first series of tests, it was considered that the problem could be a deflection of the shaft in the rigid support (B); therefore, a self-adjusting support was installed. With the self-adjusting support, no edging effect was observed in the bushing. Despite the modification of the test stand, the obtained results were difficult to unequivocally interpret.

The intensive wear of the shaft journal (Sample D) may result from the measurement of the highest bending moment and the occurrence of the largest reactions in

the supports A and B. However, following this trend and comparing the pairs of samples working at the same bending moment and where the reactions in the supports A and B are the same, but with different bending stresses (due to the use for testing the hollow shafts - Samples E and F), journals B and E show that the bending stresses have a small effect on wear, but this trend is reversed for C and F. The bending stresses for hollow shaft F are more than 30 MPa higher than sample C, but the journal shaft wear is several times smaller. Therefore, the conclusion is that the journal shaft wear is influenced by its hollowness, and it is difficult to determine the actual cause of such a heavy wear of the shaft journal in some cases.

Due to the cost and time consuming of the measurements, it is currently impossible to repeat the test. In the following part of the study, it was decided to perform finite element calculations to identify the shaft placement in the bearings and deformation of the bushing, which could have a significant impact on the wear process.

REFERENCES

1. Orndorff R., Water lubricated rubber bearings, history and new developments, *Nav Eng J*, pp. 39–52, 1985.
2. Orndorff R., Foster L., and Sheppert R., From Lab to Field: New High Performance Water Lubricated Bearings, *World Tribol. Congr. II*, pp. 1–2, 2005.
3. Litwin W., Piątkowska E., Attempt at evaluating the influence of bending stress on shaft wear processes in water lubricated sliding bearing with a rubber bushing, *Tribologia*, 1/2017, p. 81–86.
4. Zmitrowicz A. Wear patterns and laws of wear, *Journal of theoretical and applied mechanics*, vol. 44, no. 2, pp. 219–253, Warszawa 2006.



5. Wang Y., Shi X., and Zhang L., Experimental and numerical study on water-lubricated rubber bearings, *Ind. Lubr. Tribol. Exp.*, vol. 2, no. 51175275, pp. 282–288, 2014.
6. Mischczak A., Wierzcholski K., A method of the wear prognosis of sliding bearing, *Archive of mechanical Engineering*, vol. LXI, no. 4, 2014.
7. Sun J., Changlin G., Hydrodynamic lubrication analysis of journal bearing considering misalignment caused by shaft deformation, *Tribol. Int.*, vol. 37, pp. 841–848, 2004.
8. Hirani H., Verma M., Tribological study of elastomeric bearings for marine propeller shaft system, *Tribol. Int.*, vol. 42, pp. 378–390, 2009.
9. Šverko D., Šestan A., Experimental Determination of Stern Tube Journal Bearing Behaviour, *Brodo Gradnja*, vol. 61, pp. 130–141, 2010.
10. Gao G., Yin Z., Jiang D., Zhang X., Numerical analysis of plain journal bearing under hydrodynamic lubrication by water, *Tribol. Int.*, vol. 75, pp. 31–38, 2014.
11. Litwin W., Influence of local bush wear on water lubricated sliding bearing load carrying capacity, *Tribol. Int.*, vol. 61, pp. 130–141, 2010.
12. Polak A., Przenoszenie materiału w łożysku ślizgowym stal-tworzywo sztuczne, *Politechnika Krakowska im. Tadeusza Kościuszki*, pp. 21–34, 109–135, 1998.